

TYPICAL ENCLOSED OFFICE 10m2 (AT PERIMETER)

QUANTITY: 83 (44XLH; 39XRH)

OFFICES 1208, 1212, 1209, 1213, 1219, 1233, 1237, 1232, 1234, 1240, 1242, 1243, 1254, 1256, 1262, 1263, 1267, 1271, 1272, 1284, 1290, 1298

OFFICES 1206, 1210, 1214, 1216, 1207, 1211, 1224, 1231, 1235, 1241, 1236, 1252, 1260, 1261, 1265, 1269, 1288, 1296

OFFICES 1401, 1403, 1410, 1412, 1416, 1424, 1426, 1438, 1446, 1448, 1454, 1460, 1472, 1474, 1478, 1481, 1482, 1484, 1485, 1489, 1490, 1492

OFFICES 1407, 1408, 1409, 1413, 1414, 1415, 1422, 1430, 1434, 1440, 1450, 1452, 1464, 1468, 1470, 1480, 1479, 1483, 1486, 1488, 1494

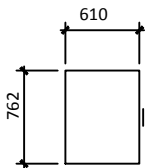
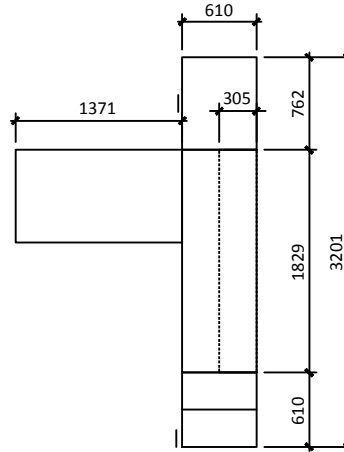
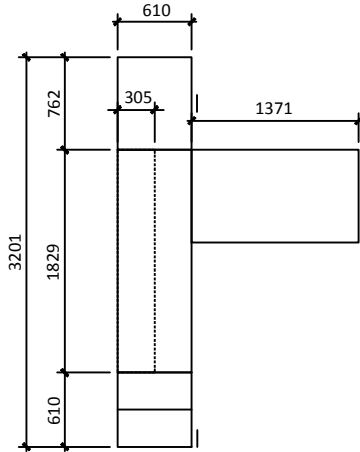

24"(610mm) X 30"(762mm) X ±72"H(1829mm)
2-HI FILE DRAWER STORAGE CABINET

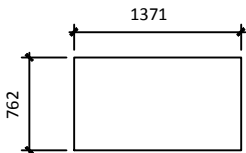

30"(762mm) X 54"(1371mm) DESK WORKSURFACE

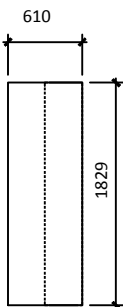

24"(610mm) X 72"(1829mm) WORKSURFACE
W/ OVERHEAD STORAGE

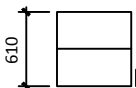

24"(610mm) X 24"(610mm) X ±72"H(1829mm)
COMBINED WARDROBE UNIT

**ATYPICAL ENCLOSED OFFICE 10m2 (INTERIOR)
QUANTITY: 4 (1XLH; 3XRH)**

OFFICE 1499

OFFICES 1455, 1495, 1497

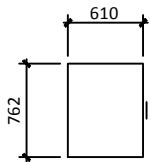
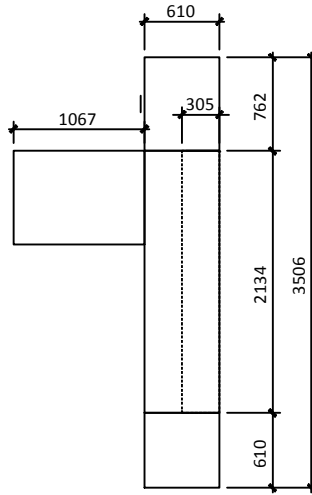
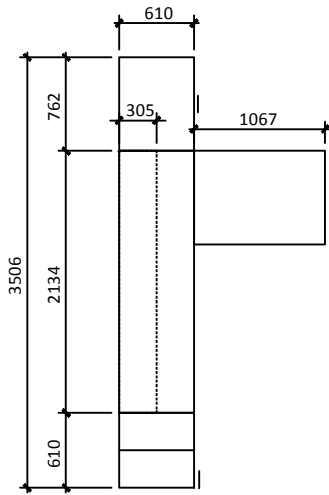

24"(610mm) X 30"(762mm) X ±72"H(1829mm)
2-HI LOCKABLE FILE DRAWER STORAGE CABINET

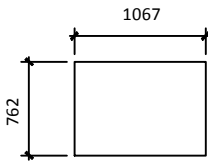

30"(762mm) X 42"(1067mm) DESK
WORKSURFACE

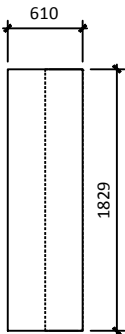

24"(610mm) X 72"(1829mm)
WORKSURFACE W/ OVERHEAD
STORAGE

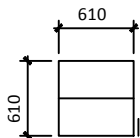

24"(610mm) X 24"(610mm) X ±72"H(1829mm)
COMBINED WARDROBE UNIT

ANNEX C – TYPICALS LAYOUT – page 3 of 7

ATYPICAL ENCLOSED OFFICE 10m2 (INTERIOR)

QUANTITY: 18 (7XLH; 11XRH)

OFFICES 1225, 1229, 1247, 1257, 1295
1421, 1445

OFFICES 1245, 1255, 1275, 1287, 1293, 12100
1419, 1439, 1447, 1449, 14100

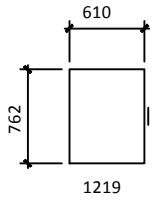
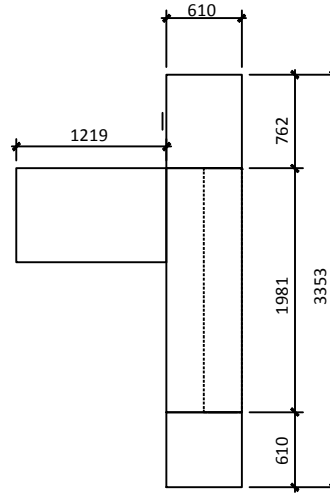
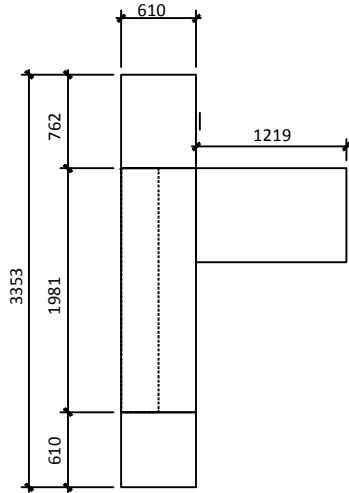

24"(610mm) X 30"(762mm) X ±72"H(1829mm)
2-HI LOCKABLE FILE DRAWER STORAGE CABINET

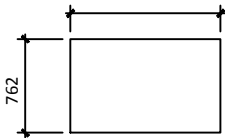

30"(762mm) X 48"(1219mm) DESK
WORKSURFACE

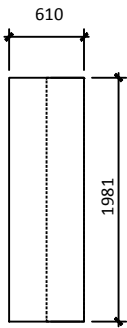

24"(610mm) X 78"(1981mm) WORKSURFACE W/
OVERHEAD STORAGE

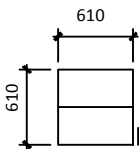

24"(610mm) X 24"(610mm) X ±72"H(1829mm)
COMBINED WARDROBE UNIT

ANNEX C – TYPICALS LAYOUT – page 4 of 7

**ATYPICAL ENCLOSED OFFICE 10m2 (INTERIOR)
QUANTITY: 8 (4XLH; 4XRH)**

OFFICES 1431, 1435, 1461, 1465

OFFICES 1429, 1433, 1457, 1463

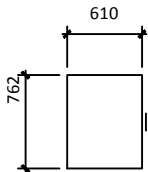
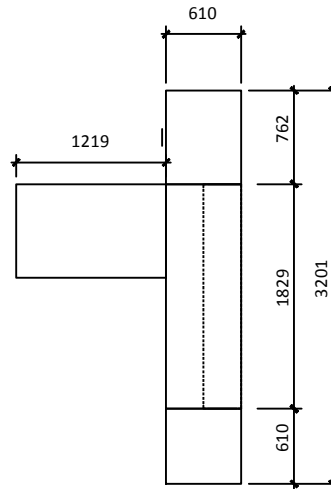
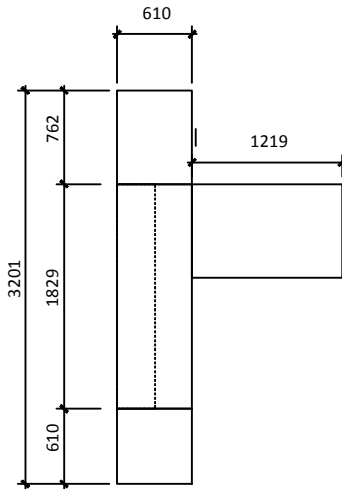

24"(610mm) X 30"(762mm) X ±72"H(1829mm)
2-HI LOCKABLE FILE DRAWER STORAGE
CABINET

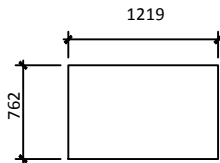

30"(762mm) X 48"(1219mm) DESK
WORKSURFACE

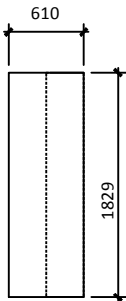

24"(610mm) X 72"(1829mm)
WORKSURFACE W/OVERHEAD
STORAGE

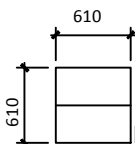

24"(610mm) X 24"(610mm) X 72"H(1829mm)
COMBINED WARDROBE UNIT

ANNEX C – TYPICALS LAYOUT – page 5 of 7

ATYPICAL DIRECTOR OFFICE (14m2)
QUANTITY: 1 (LH)

TYPICAL DIRECTOR OFFICE (14m2)
QUANTITY: 3 (1XLH; 2XRH)

OFFICE 1404

OFFICE 1228

OFFICE 1428, 1274

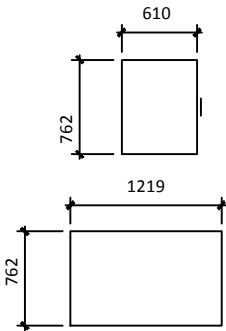
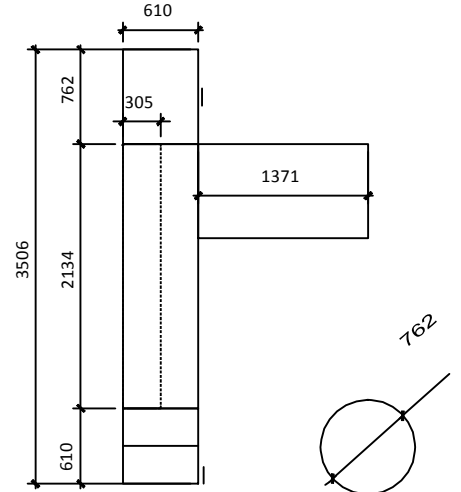
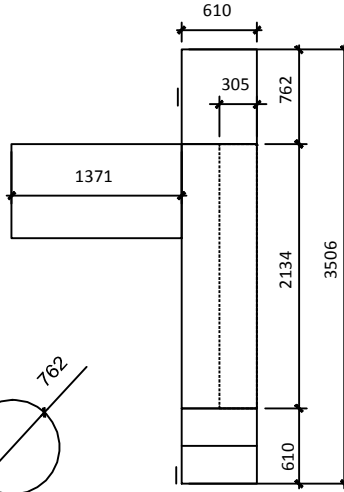
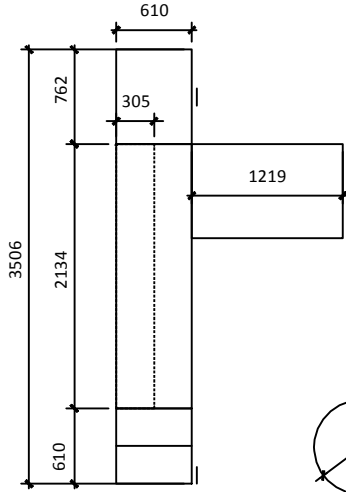

24"(610mm) X 30"(762mm) X
 ±72"(1829mm)H
 2-HI FILE DRAWER STORAGE
 CABINET

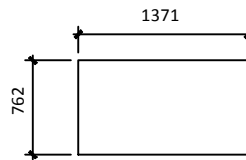

30"(762mm) X
 48"(1219mm) DESK
 WORKSURFACE

30"(762mm) X
 54"(1371mm) DESK
 WORKSURFACE

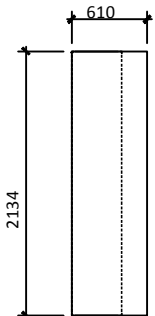

24"(610mm) X 84"(2134mm)
 WORKSURFACE W/
 OVERHEAD STORAGE

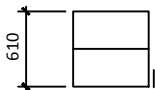

24"(610mm) X 24"(610mm)
 COMBINED WARDROBE UNIT

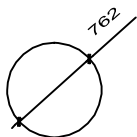

30"(762mm) ROUND MEETING
 TABLE

**DEPUTY DIRECTOR OFFICE (28m2)
QUANTITY: 2**

OFFICES 1215B, 1227B

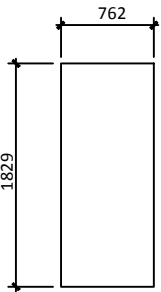
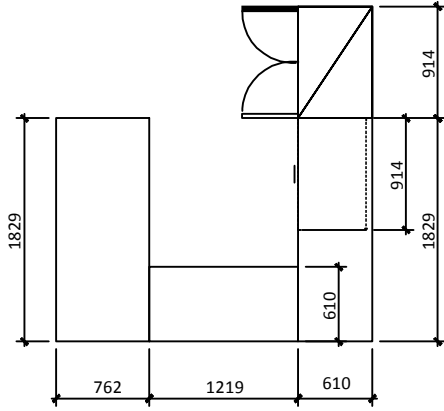
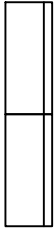
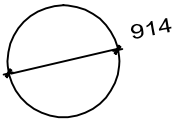

30"(762mm) X 72"(1829mm) DESK WORKSURFACE

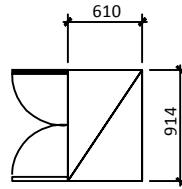

24"(610mm) X 36"(914mm) STORAGE UNIT

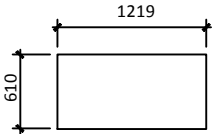

24"(610mm) X 48"(1219mm) BRIDGE/RETURN WORKSURFACE

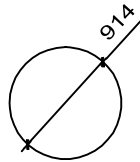

36"(914mm) DIA. ROUND TABLE

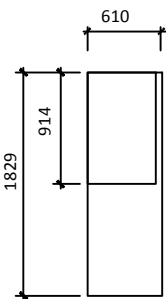

24"(610mm) X 72"(1829mm) CREDENZA W/ 36"(914mm) BOX/BOX/FILE



15"D(381mm) X 36"W(914mm) X ±72"H(1829mm) BOOKCASE

**FREESTANDING EXECUTIVE FURNITURE COMPONENT LIST
MEETING TABLES AND CREDENZAS**

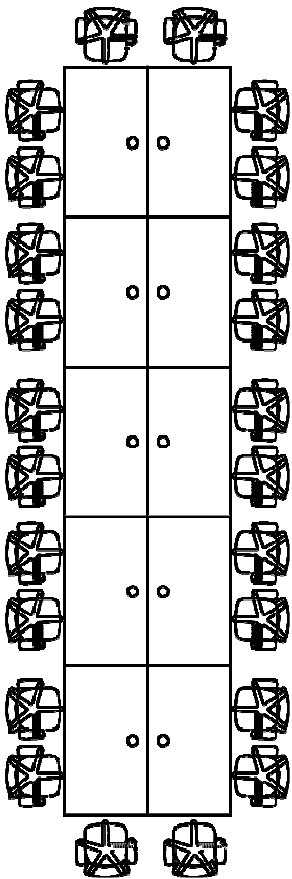

**BOARDROOM
CONFIGURATION**

BOARDROOM 1205

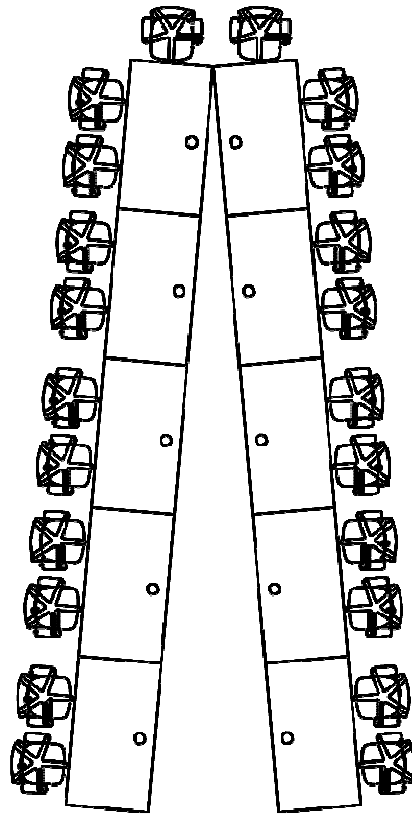

**VIDEOCONFERENCING
CONFIGURATION**

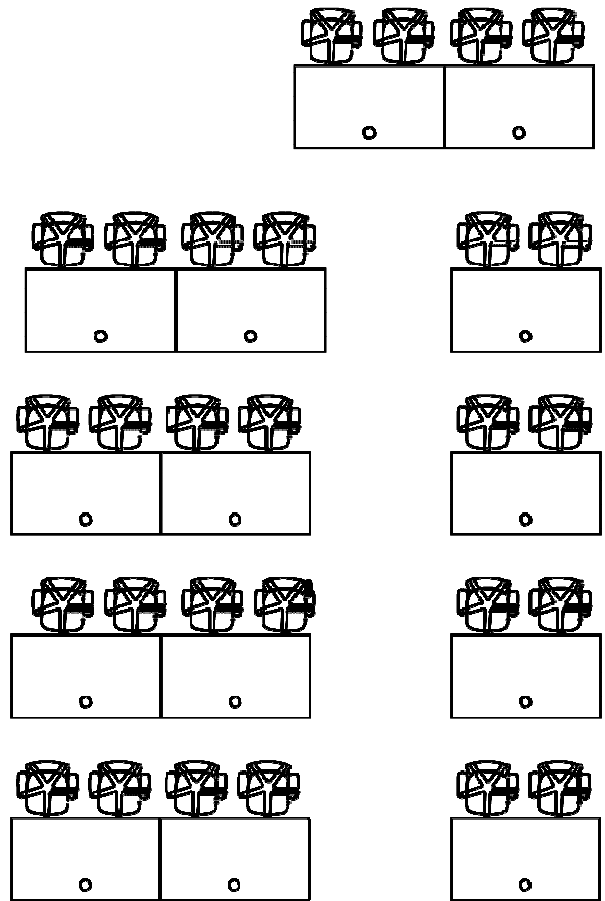

**TRAINING
CONFIGURATION**

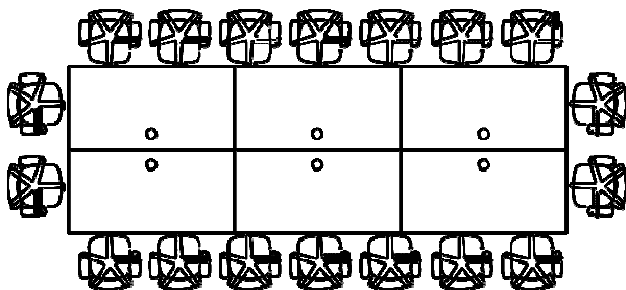

BOARDROOM 1444