



MD 15128-2013: LABORATORY FUME HOODS

**Guidelines for Building Owners, Design
Professionals, and Maintenance Personnel**

April 2013

Mechanical and Electrical Engineering

Advisory and Practices (Professional Services) Directorate
Professional and Technical Service Management
Real Property Branch
Public Works and Government Services Canada
11 Laurier Street,
Gatineau, Quebec K1A 0S5

Disponible en français

ISBN P4-32/2013E-PDF
978-1-100-22173-1

Public Information

All rights reserved. No part of this book may be reproduced by photocopying, recording, or any other means, or stored, possessed, or transmitted in or by any computer or other systems without prior written permission.

Public Works and Government Services Canada is pleased to share with you the new edition of the Mechanical Design Guidelines document *MD 15128-2013: Laboratory Fume Hoods*. It replaces an earlier *MD 15128-2008* version that was published in 2008.

The objective of this document is to provide design and testing requirements for laboratory fume hoods. This document would also help the commissioning efforts for laboratory projects in the collection of data and test results that are required to properly install and safely operate and maintain fume hood systems.

The document was developed by Mechanical and Electrical Engineering, Advisory and Practices (Professional Services) (APPS) Directorate, Professional and Technical Service Management (PTSM), Real Property Branch (RPB), Public Works and Government Services Canada (PWGSC), in consultation with specialists and engineering professionals in the regions and fume hood testing industry.

Clients, building owners, property managers, project managers, design professionals, engineers, commissioning officers and maintenance personnel should become familiar with this document and apply these guidelines in a consistent manner for federal projects throughout Canada.

This document is available in electronic format from the PWGSC RPB Publication's website at:

www.pwgsc.gc.ca/biens-property/publications-eng.html

For more information regarding this document, please contact:

National Manager, Mechanical and Electrical Engineering

Telephone: 819-956-3972

ou

Director, Advisory and Practices (Professional Services)

Telephone: 819-956-4080

E-mail: PTSMInfo.InfoGSPT@pwgsc-tpsgc.gc.ca

Travaux publics et Services gouvernementaux Canada a le plaisir de partager avec vous la nouvelle édition des lignes directrices d'ingénierie mécanique *IM 15128-2013 : Hottes de laboratoire*. Elle remplace une version antérieure, *IM 15128-2008*, qui a été publiée en 2008.

L'objectif de ce document est de fournir des exigences relatives à la conception et à l'essai de hottes de laboratoires. Le document devrait également aider à la cueillette des données et des résultats des essais nécessaires à l'installation adéquate ainsi qu'à l'exploitation et à l'entretien sécuritaires des hottes de laboratoire.

Le présent document a été élaboré par le Groupe du Génie mécanique et électrique, Conseils et pratiques (Services professionnels) (CPSP), Gestion des services professionnels et techniques (GSPT), de la Direction générale des biens immobiliers (DGBI), Travaux publics et Services gouvernementaux Canada (TPSGC), avec la collaboration des spécialistes et des ingénieurs des régions et de l'industrie de l'essai des hottes de laboratoire.

Les clients, les propriétaires d'immeubles, les gestionnaires immobiliers, les gestionnaires de projet, les professionnels de la conception, les ingénieurs, les agents de mise en service et le personnel d'entretien doivent se familiariser avec le contenu du présent document et appliquer les lignes directrices d'une façon uniforme dans les projets fédéraux partout au Canada.

Le présent document est disponible sur le site de publications de la DGBI de TPSGC :

www.tpsgc.gc.ca/biens-property/publications-fra.html

Pour plus de renseignements sur le présent document, veuillez communiquer avec :

Gestionnaire nationale, Génie mécanique et électrique.

Téléphone : 819-956-3972

ou

Directeur, Conseils et pratiques (Services professionnels)

Téléphone : 819-956-4080

Courriel : PTSMInfo.InfoGSPT@tpsgc-pwgsc.gc.ca

Anna Cullinan

Director General | Directrice générale
Professional and Technical Service Management | Gestion des services professionnels et techniques
Real Property Branch | Direction générale des biens immobiliers

PREFACE

General

This document has been developed by the Mechanical and Electrical Engineering (M&E) group within Advisory and Practices (Professional Services) (APPS), Professional and Technical Service Management (PTSM), Real Property Branch (RPB), Public Works and Government Services Canada (PWGSC), in consultation with engineers and technical specialists from the regions.

Intended Audience

Clients, building owners, property managers, project managers, design professionals, engineers, commissioning officers and maintenance personnel should become familiar with this document and apply these guidelines in a consistent manner for federal projects throughout Canada.

Feedback

Comments, additional information, and suggestions for changes, corrections, or recommendations that will improve this document are invited. For this purpose the attached form titled “Request for Changes” may be used and sent by e-mail, regular mail, or by fax to the address shown.

Conflicts

Any conflict between this document and the terms of reference, project brief, request for proposal (RFP), or other project documents should be brought to the attention of the project manager for clarification as soon as it is noted.

Background

This is a revision of the earlier Mechanical Design Guideline *MD 15128* published in January 2008.

Building, operating, and maintaining laboratory facilities require unique skills and knowledge to protect the health and safety of laboratory workers. The fume hood is one of the most common protection devices used in laboratories and merits special attention for the following reasons:

- Awareness of health and safety concerns has increased regarding improperly operating fume hoods.
- Advances in fume hood technology have made it more challenging to compare fume hood performance.
- Recognition that fume hoods must not be tested in isolation has led to recognition that the environment in which fume hoods operate must also be considered.

Formation of the PWGSC National Laboratory Knowledge Network has resulted in the sharing of laboratory resource material. This guideline will enable designers, project managers, and operating personnel to provide consistent design for the installation, procurement, testing, and maintenance of safe fume hoods in federal laboratories.

While *American Society of Heating, Refrigerating and Air-Conditioning Engineers (ASHRAE) 110-1995: Method of Testing Performance of Laboratory Fume Hoods* has defined the basic fume hood test procedures, a guideline that defines fume hood performance is not currently available. *MD 15128* has been developed to fulfill this need. A primary feature of *MD 15128* is the identification of specific pass/fail performance criteria. Additional factors affect the performance of fume hoods, and tests for the criteria related to these factors cover a broad spectrum, including variable air volume, cross draft, alarm/monitor, and other tests to supplement those identified in *ASHRAE 110*.

Acknowledgments

We acknowledge the valuable input from technical professionals from the national headquarters, the regions, and private sector industries who took time to review and comment on this document.

MD 15128-2013: Laboratory Fume Hoods REQUEST FOR CHANGES

Type of change suggested		
<input type="checkbox"/> Correction of information	<input type="checkbox"/> Deletion of information	<input type="checkbox"/> Addition of Information
Location of suggested changes		
If necessary, photocopy relevant page(s) of this manual and attach to this sheet.		
Page(s): _____	Chapter(s): _____	Paragraph No(s): _____
Details of suggested changes		
Name: _____	Organisation: _____	
Telephone No.: _____	Date: _____	
Signature: _____		

(Use additional sheets if necessary)

Send to:

National Manager,
Mechanical and Electrical Engineering,
Advisory and Practices (Professional Services),
Professional and Technical Service Management (PTSM),
Real Property Branch,
Public Works and Government Services Canada
Portage III 8A1-11 Laurier Street
Gatineau, Quebec K1A 0S5
Telephone: 819-956-3972 | **Fax:** 819-956-4441
E-mail: PTSMInfo.InfoGSPT@tpsgc-pwgsc.gc.ca

TABLE OF CONTENTS

Chapter 1:	General01
	1.1 Introduction and Purpose.....	.01
	1.2 Definition of 'Fume Hood'.....	.01
	1.3 Scope of this Guideline.....	.01
	1.4 Exclusions.....	.02
	1.5 Associated Documents.....	.02
	1.6 Responsibility for Laboratory Safety.....	.02
	1.7 Responsibility for Laboratory Fume Hood Selection.....	.03
	1.8 Operations and Maintenance (O&M) Manuals.....	.03
	1.9 Fume Hood Log Book.....	.03
	1.10 Definitions.....	.03
	1.11 Acronyms and Abbreviations.....	.05
Chapter 2:	Types of Laboratory Fume Hoods06
	2.1 General.....	.06
	2.2 Constant Air Volume (CAV) Bypass Fume Hoods.....	.06
	2.3 Variable Air Volume (VAV) Fume Hoods.....	.07
	2.4 High Performance (HP) Fume Hoods.....	.07
	2.5 Other Fume Hoods.....	.07
Chapter 3:	Laboratory Fume Hood Design Elements10
	3.1 General.....	.10
	3.2 Design Elements for Constant Air Volume (CAV) Bypass Fume Hoods.....	.10
	3.3 Design Elements for Variable Air Volume (VAV) Fume Hoods.....	.14
	3.4 Design Elements for High Performance (HP) Fume Hoods.....	.14
	3.5 Fume Hood Accessories.....	.14
	3.6 Laboratory Services to Laboratory Fume Hoods.....	.16
	3.7 Integration with Room HVAC and Exhaust Systems.....	.17
	3.8 Definition of Fume Hood Operating Modes.....	.18
	3.9 Fume Hood Operation, Controls, and Alarms.....	.18
	3.10 Base Furniture.....	.20
	3.11 Noise Levels.....	.20
	3.12 Governing Standards.....	.20
	3.13 Tests.....	.20

Chapter 4:	Fume Hoods and Laboratory Layout	21
4.1	Laboratory Layout, Fume Hood Locations, and Fume Hood Performance	21
4.2	Locating Supply Air Diffusers with Respect to Fume Hoods.	21
4.3	Exit Routes from the Laboratory.	22
Chapter 5:	Fume Hood Tests Integral with Commissioning Efforts	23
5.1	General	23
5.2	New Fume Hoods Installed in New or Renovated Laboratory	24
5.3	Existing Fume Hoods Due for Annual Testing	24
Chapter 6:	Fume Hood Performance and Testing Requirements	27
6.1	Fume Hood Performance	27
6.2	Qualifications of Testing Agent.	28
6.3	PWGSC Performance Criteria	28
6.4	Tests at the Manufacturer’s Facility	32
6.5	On-Site Tests	33
6.6	Examination of Results on Re-Tests of Existing Fume Hoods.	36
6.7	Recommended Test Sequences.	36
6.8	Coordination	36
6.9	Test Procedures	36
Appendix A:	Smoke Visualization Test Protocol	A-01
A.1	Purpose.	A-01
A.2	Smoke Visualization Tests Apparatus	A-01
A.3	Smoke Generator	A-01
A.4	Power Supply	A-03
A.5	Smoke Diffuser	A-03
A.6	Smoke and Air Transfer Fan	A-03
A.7	Fluid Flow Meter	A-03
A.8	Fluid Flow Adjustment Valves.	A-03
A.9	Smoke Transfer Hose.	A-05
A.10	Smoke Visualization Test Protocol	A-05
A.11	Smoke Diffuser Locations.	A-05
A.12	Smoke Generator Discharge Volume Adjustment Procedure	A-08
A.13	Smoke Visualization Test Procedures	A-09
A.14	Describing and Rating Air Flow Patterns.	A-10
A.15	Recommended Performance Criteria.	A-11
A.16	Equipment Set-Up Diagrams	A-13
A.17	Fume Hood Smoke Generator/Diffuser Testing Apparatus	A-17
A.18	Design Drawings—Smoke Diffuser.	A-19
Appendix B:	Use and Maintenance of Laboratory Fume Hoods	B-01
B.1	Proper Operation of Laboratory Fume Hoods— For Users.	B-01
B.2	Proper Maintenance of Fume Hoods—For O&M Personnel	B-02
B.3	Fume Hood Log Book	B-03

Appendix C: On-Site Test Forms	C-01
C.1 Commissioning Checklist	C-01
C.2 Performance Verification (PV) Report Forms— Hood and Systems	C-03
C.3 Forms for Test Results—CAV	C-04
C.4 Forms for Test Results—VAV	C-08
C.5 Statement of Conformance	C-13
Appendix D: Fume Hood Operation, Controls, and Alarms	D-01
D.1 Dual Speed Exhaust Fans	D-01
D.2 Operator’s Panel	D-02
D.3 Control Panel	D-02
Bibliography	BIB-01

List of Tables

Table 3-1:	Colour Coding and Identification of Service Fixtures	17
Table 5-1:	Cooperative Efforts in the Purchase, Installation, and Testing of Fume Hoods	25
Table 6-1:	Cross Draft Tests	29
Table 6-2:	Velocity and Flow Tests	29
Table 6-3:	Smoke Visualization Performance Criteria	30
Table 6-4:	Tracer Gas Tests	31
Table 6-5:	Additional Required Tests	31
Table 6-6:	Test Equipment Specifications	32
Table 6-7:	Fume Hood Test Frequency	35

List of Figures

Figure 2-1:	Typical Bypass Fume Hood	06
Figure 4-1:	Diagram Showing Good, Better, and Best Locations for Supply Diffusers with Respect to Hood Opening	22
Figure 5-1:	Schematic to Illustrate Relationship Between Fume Hood(s) and Lab Ventilation	23
Figure 6-1:	Cross Draft Testing	37
Figure 6-2:	Simplified Diagram of Experimental Setup for VAV Response Test	39
Figure 6-3:	Speed of Response and Stability	40
Figure 6-4:	Mannequin and Ejector During Sash Movement Containment Tests	42
Figure 6-5:	Simulated Apparatus Test Setup	44
Figure A-1:	Smoke Generator	A-02
Figure A-2:	Analog Controller	A-02
Figure A-3:	Power Supply	A-02
Figure A-4:	Smoke Diffuser	A-02
Figure A-5:	Smoke and Air Transfer Fan	A-02
Figure A-6:	Flow Meter	A-04
Figure A-7:	Flow Adjustment Valve	A-04

Figure A-8: Smoke Transfer Hose A-04
Figure A-9: Smoke Transfer Hose Connection Clamp A-04
Figure A-10: Smoke Diffuser Positions for Hoods with Width 1.8 m or Less A-06
Figure A-11: Smoke Diffuser Positions for Hoods with Width of 2.4 m A-06
Figure A-12: Smoke Diffuser Positions for Hoods with Widths Greater than 2.4 m A-06
Figure A-13: Horizontal Sash Positions A-06
Figure A-14: Floor-Mounted Hoods—Vertical Sash Configurations A-08
Figure A-15: Floor-Mounted Hoods—Horizontal Sash Configurations A-08
Figure A-16: Mannequin Placement A-10
Figure A-17: Smoke Observation A-11

CHAPTER 1**GENERAL**

1.1 Introduction and Purpose

Experience has demonstrated that considerable confusion exists regarding laboratory fume hood design and installation. There is also a lack of understanding of fume hood performance criteria and test methods.

This guideline is intended to improve this situation and to provide a consistent approach to the specification, testing, operation, and maintenance of fume hoods in laboratories managed by PWGSC as well as by other Government of Canada departments and agencies.

MD 15128 does not replace the *ANSI/ASHRAE 110-1995 Method of Testing Performance of Laboratory Fume Hoods* standard but rather is complementary to it. While *ANSI/ASHRAE 110* describes how to do fume hood tests, *MD 15128* provides reasonable pass/fail determinants in assessing fume hood test results.

1.2 Definition of ‘Fume Hood’

In the context of this guideline, “fume hood” means “a boxlike structure enclosing a source of potential air contamination, with one open or partially open side, into which air is moved for the purpose of containing and exhausting air contaminants, generally used for bench-scale operations but not necessarily involving the use of a bench or table.”—*ANSI/ASHRAE 110-1995*

1.3 Scope of this Guideline

This guideline provides design and test requirements for constant volume bypass, variable air volume, and high-performance laboratory fume hoods only. The pass/fail criteria stated herein apply to all new installations and retrofits of laboratories containing fume hoods. Note that existing and older fume hoods may be incapable of meeting the performance criteria contained herein. The laboratory director should take appropriate assessment and corrective measures where fume hood performance is uncertain. The ultimate decision regarding continued use of fume hoods that fail to meet one or more of the pass/fail criteria rests strictly with the laboratory director.

1.4 Exclusions

This guideline does not cover the following:

1. Standards for special equipment such as biological safety cabinets or laminar flow clean benches. These are occasionally confused with laboratory fume hoods but have a very different usage.
2. Requirements for canopy exhaust hoods, snorkels (sometimes called “local exhaust arms” or “elephant trunks”), slotted hoods, bench-top exhaust, and all other exhaust devices.
3. Requirements for laboratory fume hood exhaust systems.
4. Details of the interrelationship between fume hood exhaust systems and laboratory HVAC and exhaust systems.
5. Requirements for perchloric acid fume hoods and their exhaust systems. These are described in *MD 15129: Perchloric Acid Fume Hoods and Their Exhaust Systems*.
6. Requirements for radioisotope fume hoods and their exhaust systems. These are described in Canadian Nuclear Safety Commission document *GD-52: Design Guide for Nuclear Substance Laboratories and Nuclear Medicine Rooms*.

1.5 Associated Documents

1. This guideline supports the project brief, which is the primary reference document for each project.
2. A bibliography is provided at the end of this document.

1.6 Responsibility for Laboratory Safety

Part II of the Canada Labour Code is the basis for Canadian Occupational Health and Safety legislation and requires that the employer (in this case the laboratory director) take all necessary means to protect the health and well-being of all workers.

This includes the use of measures to ensure proper operation of fume hoods and other protective equipment. Hazards to the worker through improper design or installation of fume hoods should be avoided by adopting the following procedures:

1. All new fume hood installations should meet or exceed the PWGSC performance criteria found herein.
2. Changes in the use of fume hoods should only be made with the full knowledge and approval of the laboratory director.
3. The designer and the laboratory director, with the assistance of the laboratory fume hood manufacturer, should develop detailed safety directives **AND** provide training in proper fume hood usage to all laboratory users and training in fume hood maintenance to the Operations and Maintenance (O&M) personnel.
4. The laboratory director should organize regular reviews of operation and set in place procedures for reporting and correcting defective equipment and enabling improvements in O&M procedures.

1.7 Responsibility for Laboratory Fume Hood Selection

Selection of the most suitable fume hood to meet the laboratory program requirements is the responsibility of the laboratory director. This is because the “science” aspect of fume hood use cannot be ignored. For instance, the nature of the processes and the chemicals used in the fume hood will affect the required performance criteria. Discussions with the laboratory director and the designer will indicate whether the criteria contained in this document are sufficient to safely address the program(s) at the specific laboratory.

1.8 Operations and Maintenance (O&M) Manuals

1. All documentation should form part of the O&M manuals and should be developed concurrently with the design of the facility.
2. It is imperative that the O&M manuals (which form an integral part of the Building Management Manual) are up to date at all times. The facility manager is responsible for this, in consultation with the laboratory director.
3. Training documentation (e.g., videos, etc.) should be placed in the O&M manuals.
4. The requirements for the O&M manuals can be obtained from PWGSC’s series on *Commissioning Manuals and Guidelines*.
5. Reference should also be made to [Appendix B: Use and Maintenance of Laboratory Fume Hoods](#).

1.9 Fume Hood Log Book

Place log book at each fume hood for entering pertinent data, information, test results, history of use, etc. See [Appendix B: Use and Maintenance of Laboratory Fume Hoods](#) for a sample table of contents.

1.10 Definitions

Airfoil, bottom:	Curved or angular horizontal member running the full width of the fume hood between the work surface and the bottom of the sash when closed, and providing a permanent slot approximately 25 mm high to permit a smooth “sweeping” action of air across the entire width of the work surface while minimizing entry turbulence.
Airfoil, side:	Curved or angular vertical members at each side of the fume hood entrance, designed to minimize eddies and promote smooth entry of air into the hood.
Baffles:	Adjustable panels located across the fume hood at the rear of the work space between the work surface and the point of connection to the fume hood exhaust system, and forming the front face of the rear plenum. Designed to enable control of airflow distribution and capture within the hood.
Bypass:	An arrangement to allow air to enter the fume hood other than through the sash opening, designed to ensure a relatively constant exhaust airflow rate regardless of the position of the sash, and to limit the maximum face velocity.

Contaminants:	Dust, fumes, gases, vapours, aerosols, allergens, particulate matter, etc. They may be harmless, noxious, poisonous, toxic, allergenic, odourless, odourous, corrosive, flammable, explosive, radioactive, etc.
Face Velocity:	Speed of air entering the fume hood through the sash opening, and measured in the plane of the sash.
Fully Open:	The maximum height to which the sash can be opened above the bottom airfoil. It is limited only by the design of the fume hood.
Gross Challenge:	A method of providing a large, visible volume of smoke should be available to allow a gross challenge to the hood to observe its ability to contain and exhaust fumes. Care is required when interpreting the observations since large amounts of smoke generation often produce sufficient volume and momentum to affect the observations.
Lazy Airflow:	An airflow problem in a hood that is revealed when the smoke generated in a smoke challenge remains on the work surface without smoothly flowing to the back baffle.
Local Challenge:	A small, visible stream of smoke is produced by a smoke pencil to allow a local challenge to the hood to observe its ability to contain and exhaust fumes. This smoke should be able to show airflow patterns within the hood without generating such volume or momentum that it affects the observations.
Normal Operating Position:	The operating position of the sash above the bottom airfoil at which normal operations and manipulations within the fume hood are performed. It is a single, specific height, typically in the 350 to 500 mm range, depending upon the laboratory program requirements, and must be clearly labelled on the fume hood. It is also referred to as “design sash position.”
Reverse Flow:	An airflow problem in the hood that is revealed when the smoke released in the hood moves forward toward the front of the hood. This term does not apply to the forward motion of the roll inside the hood that occurs in the upper cavity of the hood above the hood opening, or to the cyclonic motion that occurs behind a closed horizontal sash.
Sash:	Transparent operable screen between the fume hood user and the interior of the fume hood, adjustable either vertically, horizontally, or both, and capable of providing protection for the fume hood user.
Sash Opening:	The aperture in the front of the fume hood through which all work and manipulations are made.
(Sash) Plane of the Sash:	The imaginary vertical plane from the midpoint of the sash frame depth at the bottom of the sash to the point of contact on the airfoil sill.
Service Fitting:	Laboratory fitting mounted in, on, or fastened to, the laboratory fume hood to control supply of the service to the fume hood.

- Slot:** Horizontal opening in or between each baffle panel designed to regulate air flow distribution and to maintain the desired face velocity distribution across the entire sash opening.
- Superstructure:** That portion of the laboratory fume hood supported by the work surface, the base furniture, or the laboratory floor.
- Vortex Roll:** The rotation of air in the upper cavity of the hood. The roll is induced by the momentum of the air entering the hood through the hood opening.

1.11 Acronyms and Abbreviations

AI	As Installed	HP	High Performance
AM	As Manufactured	NDZ	No Diffuser Zone
ANSI	American National Standards Institute	NFPA	National Fire Protection Agency
ASHRAE	American Society of Heating, Refrigerating and Air-Conditioning Engineers	O&M	Operations and Maintenance
AU	As Used	PV	Performance Verification
CAV	Constant Air Volume	PVC	Polyvinyl Chloride
CSA	Canadian Standards Association	TAB	Test and Air Balance
GFI	Ground Fault Interrupter	VAV	Variable Air Volume

CHAPTER 2

TYPES OF LABORATORY FUME HOODS

2.1 General

A fume hood or other suitable enclosure is required to confine those contaminants that must not be released into the laboratory environment. This is essential for providing safe working conditions for the fume hood user and other laboratory personnel.

A laboratory fume hood is designed for a specific use and may not satisfy other laboratory work requirements.

The following sections describe the most commonly used types of fume hoods available today.

2.2 Constant Air Volume (CAV) Bypass Fume Hoods

Like all other laboratory fume hoods, constant air volume (CAV) bypass fume hoods have fixed vertical airfoils, or angled aerodynamic entries, on each side. There is a fixed horizontal airfoil just below the sash and above the work surface. In addition, factory set baffles are found at the rear to provide optimal air flow patterns. This is to maintain a relatively uniform air velocity through the sash opening independent of sash position.

Bypass fume hoods are designed and constructed to allow room air to enter the fume hood by a route other than the sash opening, when the sash is being lowered. This limits the increase in face velocity through the sash opening and results in a relatively constant exhaust airflow rate over the operating range of the bypass. The principle is illustrated in [Figure 2-1](#).

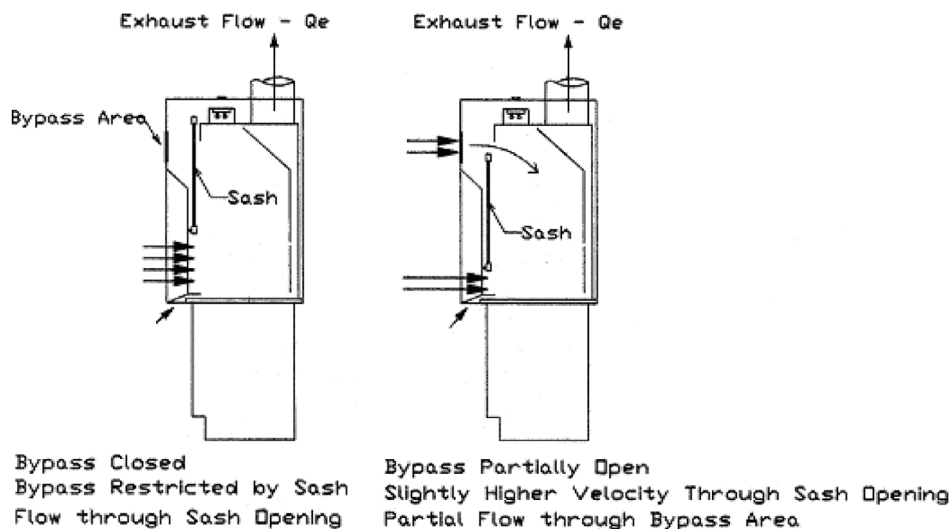

Figure 2-1: Typical Bypass Fume Hood

These fume hoods are sometimes called “balanced flow” fume hoods because the exhaust flow is manually balanced initially to provide a constant face velocity through the sash opening in accordance with the requirements of [Table 6-2: Velocity and Flow Tests](#) found in [Chapter 6: Fume Hood Performance and Testing Requirements](#).

While the height of a full opened sash is approximately 700 mm, the “normal operating position” will constitute a single, specific position of sash opening, often in the range of 350 to 500 mm. This position must be clearly labelled on the fume hood and a sash stop should be provided at this position. The “normal operating position” imposes a significant restriction on the user in carrying out procedures within the fume hood, but is necessary to provide optimum protection of the user from contaminant escape.

2.3 Variable Air Volume (VAV) Fume Hoods

Many of the design features of variable air volume (VAV) fume hoods are similar to those of constant air volume bypass fume hoods. However, VAV fume hoods maintain constant face velocity by adjusting the total exhaust air flow as the sash opens or closes, using sophisticated fume hood and laboratory controllers. This approach minimizes energy costs while maintaining operator protection. Some bypass fume hoods can be retrofitted for use as VAV hoods by the use of a “blank off” plate or restricted bypass opening, which effectively eliminates or reduces excessive bypass air entering the fume hood.

2.4 High Performance (HP) Fume Hoods

Also known as “reduced flow” or “low-velocity” fume hoods, high performance fume hoods have been developed in response to the need for conserving energy. They are similar to CAV bypass hoods but operate safely at reduced face velocities due to their superior aerodynamic features.

For the purposes of this guideline, a “high performance” fume hood must provide equivalent containment performance (meet criteria as stated in [Section 6.3: PWGSC Performance Criteria](#)) at a nominal face velocity of 0.35 m/s when the sash is at its normal operating position, and it must provide containment at full sash opening (see [Table 6-2: Velocity and Flow Tests](#)).

2.5 Other Fume Hoods

2.5.1 Floor-Mounted (“Walk-In”) Fume Hoods

The term “walk-in fume hood” gives the false impression that it is safe to enter these hoods. They can be described more correctly as “floor-level” or “floor-mounted” fume hoods, as they are absolutely unsafe to enter. They are suitable for use with large apparatus, roll-in equipment, and large instruments where traditional bench-top fume hoods may be inadequate for containment of fumes.

The sashes may be in two or more sections, double vertical, or other suitable configurations. The sashes and the doors should provide full-height visibility. Access panels on each side should be provided for accessibility to all services.

2.5.2 Perchloric Acid Fume Hoods

The perchloric acid fume hood is designed for a single special purpose, i.e., containment of perchloric acid fumes. It should not be used for any other purpose, due to the highly dangerous characteristics of perchloric acid and its byproducts. This type of fume hood is characterized by the use of particular construction materials and the “wash-down capability” of hood and all ductwork. For further details refer to *MD 15129: Perchloric Acid Fume Hoods and Their Exhaust Systems*.

2.5.3 Radioisotope Fume Hoods

The radioisotope fume hood is specifically designed for handling radioactive isotopes and conforms to Canadian Nuclear Safety Commission document *GD-52: Design Guide for Nuclear Substance Laboratories and Nuclear Medicine Rooms* and to *CSA Z316.5: Fume hoods and Associated Exhaust Systems*.

Document *GD-52* also provides details relating to radioisotope laboratory HVAC and exhaust systems. For instance, the exhaust ductwork is to be marked with radiation warning symbols, and all exhaust air from a radioisotope lab must exit through the fume hood.

All users of radioactive material must be registered on a licence issued by the Atomic Energy Board of Canada (AEBC). The licence outlines a set of conditions that must be followed for the use and disposal of the prescribed radioisotopes.

2.5.4 Other Special-Purpose Fume Hoods

Many other special-purpose laboratory fume hoods are available but are not included in this guideline for the sake of brevity.

The need for these special fume hoods should be determined by the program requirements and by the laboratory director.

2.5.5 Auxiliary Air Fume Hoods

An auxiliary air fume hood uses a plenum to supply unconditioned (outside) air directly above the face of the fume hood. In the past, they have been installed in laboratories which had insufficient makeup air or where there was a desire to save the energy otherwise required to heat/cool the supply air. They are not included in this guideline since they are no longer recommended by PWGSC as per *National Building Code (NBC) Art. 6.2.3.11.3*, “Wherein makeup air facilities are intended to introduce air directly from the outdoors to occupied parts of the building in winter. They shall incorporate means of tempering that air to maintain the indoor design temperature”.

2.5.6 Ductless Fume Hoods

Ductless fume hoods recirculate their exhaust air within the laboratory space. They rely on specially treated carbon filter(s) to cleanse the exhaust air of harmful chemicals prior to its recirculation. However, as noted in *ANSI Z9.5: Laboratory Ventilation*, there must be thorough assurances that safety of laboratory personnel will not be compromised, including:

1. An assurance in writing from the fume hood manufacturer that the specific application is acceptable.
2. A list of approved chemicals provided by the manufacturer.
3. Operating and maintenance information, particularly with respect to test procedures.

Some testing procedures and safe work practices are stated in the Scientific Equipment and Furniture Association published document *SEFA 9: Recommended Practices for Ductless Enclosures*.

CHAPTER 3

LABORATORY FUME HOOD DESIGN ELEMENTS

3.1 General

This chapter describes some of the essential requirements for constant air volume (CAV) bypass, variable air volume (VAV), and high performance (HP) fume hoods. These requirements ensure that the fume hoods are serviceable, durable, and safe to operate.

3.2 Design Elements for Constant Air Volume (CAV) Bypass Fume Hoods

3.2.1 Face Velocity

The face velocity should provide containment when the sash operates at its normal position. Traditionally, 0.5 m/s has been used as a target average face velocity. High performance fume hoods use values as low as 0.3 m/s. See [Chapter 6: Fume Hood Performance and Testing Requirements, Table 6-2: Velocity and Flow Tests](#).

3.2.2 Total Exhaust Air Flow Rate

The total fume hood exhaust air flow rate with the sash in any position equals the sum of the rates of air flow entering the hood through the following means:

1. The sash opening, so as to maintain the face velocity specified above
2. The bottom airfoil
3. The bypass grill
4. Leakage air.

3.2.3 Airfoil

Airfoils should be used in conjunction with the raised portion of the non-spill work surface. The horizontal airfoil should be of 1.5 mm stainless steel, type 316 with #4 satin finish, typically installed approximately 25 mm above the raised portion of the work surface. It should be designed and installed for eddy-free entry of air into the fume hood. The air should sweep across the work surface, minimizing eddies and lessening the possibility of fumes generated near the front of the fume hood from escaping. Airfoil width should project into the fume hood beyond the plane of the sash. The sash should close on top of the airfoil, leaving a 25 mm opening below for entry of air. The airfoil should be designed to eliminate reverse flow within 75 mm of the plane of the sash.

3.2.4 Bypass Grille

The bypass grille should be of the same material as exterior panels. It should be located in the front face of the fume hood, to permit air entry as the sash is lowered or to close off the air flow as the sash is raised. It should be sized to ensure that exhaust air quantity remains relatively constant within the normal operation range of the sash, and that face velocity does not exceed 1.25 m/s with the sash at a 150 mm open position (see [Table 6-2: Velocity and Flow Tests](#)).

3.2.5 Control of Face Velocity by User

The fume hood user should **NOT** have any means of adjusting the face velocity.

3.2.6 Sash Opening

The normal operating position of the sash (or sash design position) should conform to all of the following requirements:

1. Be determined in writing by the laboratory director.
2. Form part of the fume hood purchase specification.
3. Be stated by the manufacturer in its product data supplied with the fume hood.
4. Be labelled on the front of the fume hood and be restricted by the sash stop.

For horizontal or combination sashes, the horizontal sliding panels should be arranged so that the maximum opening area for any orientation or configuration of the sash panels does not exceed the design opening area.

3.2.7 Sash Stop

A physical sash stop should prevent the sash from opening further than its normal operating position, under regular working conditions. The sash may be opened further by the use of a special key or tool, or by purposely releasing the sash stop, but should reset automatically when the sash is lowered again.

3.2.8 Sash and Sash Handle, Grab Bar, and Frame

The sash should be 6.4 mm thick laminated safety glass in a corrosion-resistant PVC track, with appropriate provisions for raising and lowering, or sliding horizontally, or both.

The sash handle should be of type 316 stainless steel with #4 satin finish, and should not generate eddies in the plane of the sash opening. It should be thin enough in profile to minimize interference with the line of sight of the fume hood user.

Where heat is considered to be a potential source of danger, the sash may have a Mylar overlay bonded to the exterior surface.

3.2.9 Counterbalance Mechanism

The counterbalance mechanism should use a single counterweight, stainless steel wires on ball bearing pulley assemblies. A cable-retaining device should be provided, assembled to prevent tilting of the sash during operation.

Spring counterbalance mechanisms are not acceptable.

The sash should move easily and quietly and remain in place wherever it is stopped.

The sash should open and close against rubber bumper stops, installed so that the user can readily adjust the sash opening when moving the sash from either end. The design should ensure that, in the event of a failure of the counterbalance mechanism, the sash cannot fall within 50 mm of the bottom airfoil. This is in order to avoid the potential for serious injury to the fume hood user.

3.2.10 Baffles

Baffles should be fabricated of the same material as the interior panels. They should be designed to the following requirements:

1. Provide multiple exhaust slots adjustable in width.
2. Minimize the variation in face velocity across the sash opening when the sash is in its normal operating position.

The baffles should be set at the factory, **permanently marked**, and fixed on the basis of prototype testing. Failing this, they should be set only by experienced personnel during commissioning. Baffles should not be adjusted by the user without a subsequent verification of the fume hood performance.

Note: Fume hood performance depends upon correct baffle position. Therefore baffles should not be adjusted by users. Baffle openings should not be set based on the specific gravity of various fumes, whether greater or less than that of air. The turbulence within the hood and the relative concentrations of fumes negate any supposed effect from heavier-than-air or lighter-than-air fumes under most laboratory hood usage conditions.

3.2.11 Exhaust Duct Collar

The exhaust duct collar should be fixed to the top rear of the fume hood and constructed of the same material as the interior panels. The collar should have bell-mouthed entry and be flanged for easy connection to the exhaust duct. It should be sized to provide exhaust air velocities of 5.0 to 7.5 m/s to achieve the following requirements:

1. Minimize pressure drop and noise generation.
2. Ensure that normally encountered particulates remain suspended in the air stream.

3.2.12 Interior Panels

The material of construction should be selected according to the requirements of the laboratory director, the project brief and/or the tender specifications.

If fibreglass reinforced plastic (FRP) is used, it should be 6.4 mm thick, heat- and chemical-resistant and finished with a non-porous white surface. Screws should be stainless steel.

If stainless steel is specified, it should be 1.2 mm thick 304 stainless steel (#4 satin finish), with all interior corners radius to 12 mm and all welds ground smooth.

Interior access panels should have gaskets, and should be removable and replaceable without special tools.

3.2.13 Exterior Panels

Exterior panels should typically be of cold rolled steel, finished with powder coating. Exterior panel members should be fastened by means of concealed devices; exposed screws are not acceptable. Panels should be readily removable to allow access to plumbing lines and fixtures. All screws should be stainless steel.

Provide top closure panels of the same material and finish as the hood exterior to enclose ductwork up to the ceiling.

3.2.14 Superstructure

The superstructure should be double wall construction, consisting of an outer sheet metal shell and an inner liner of corrosion-resistant material. The double wall should house and conceal steel framing members, attaching brackets and remote-operating service fixture mechanisms. The entire assembly should be a rigid, self-supporting unit.

3.2.15 Vertical Sides of Fume Hood Face

The vertical sides should have a radius airfoil shape to reduce eddies and to promote smooth entry of air into the fume hood. If service fixtures are installed, they should not disturb the air flow pattern. Removable panels may be provided for maintenance of sash counterbalance mechanisms and service valves.

3.2.16 Fastenings

All fastenings inside the fume hood should be corrosion-resistant and remain unaffected by repeated operations.

3.2.17 Work Surface

The work surface should be recessed at least 12.5 mm to contain spills. It should be completely sealed at all interior panels and have covered corners plus raised surface all around the work surface. The choice of material should suit the application; it should be specified by the laboratory director and included in the project brief.

3.2.18 Light Fixture

The light fixture should be a T-5 or T-8 fluorescent rapid start fixture with electronic ballast, or a LED fixture, mounted on the exterior of the fume hood with the safety lens sealed to isolate the fixture from the fume hood interior. It should be serviced from outside the hood and should provide a minimum of 860 lux (80 foot candles) of interior illumination at the work surface. The switch should be flush-mounted in a weatherproof box in the side post of the fume hood. The sealant between lens and fume hood should be of an approved type.

Note: The use of germicidal UV lights should be avoided, due to health and safety concerns.

3.3 Design Elements for Variable Air Volume (VAV) Fume Hoods

VAV fume hoods should meet all the requirements for constant air volume (CAV) bypass fume hoods indicated in [Section 3.2](#) with the exception of the requirements for bypass grilles, duct transport, and outlet collar dimensions. In addition, they should meet the following requirements:

3.3.1 Additional Testing

Additional testing of VAV hoods over that required for constant air volume fume hoods is critical. It includes VAV response and minimum flow tests, as described in [Table 6-2: Velocity and Flow Test in Chapter 6: Fume Hood Performance and Testing Requirements](#).

Note: In VAV hoods, exhaust air flow is typically controlled using a sash position sensor or a through-the-wall (TTW) sensor. The response characteristics for the system are as important as the response time. There is a tendency to overshoot the face velocity set point and to take time to settle at the appropriate value. Improper location of the TTW sensor (e.g., in an unstable location) will exacerbate the situation.

3.3.2 Minimum Air Flow

As stipulated in *ANSI/AIHA Z9.5: Laboratory Ventilation*, a minimum exhaust rate of 150 to 375 air changes per hour within the fume hood is required. This consideration is for hoods when the sash is closed while unattended processes are occurring within the hood.

3.4 Design Elements for High Performance (HP) Fume Hoods

High performance fume hoods have been accepted as a legitimate alternative to more traditional fume hoods. They incorporate enhanced aerodynamic design features, particularly the airfoil sill, sash handle, side posts, and rear baffles.

It is important that HP hoods meet all performance requirements indicated in [Section 6.3: PWGSC Performance Criteria](#), in [Chapter 6: Fume Hood Performance and Testing Requirements](#).

Note: Face velocity performance criteria of 0.3 to 0.35 m/s for high performance fume hoods may conflict with local safety and health regulations if the face velocity falls outside the range of these regulations. If this occurs, a variance must be obtained prior to the use of such hoods.

3.5 Fume Hood Accessories

In selected applications, additional elements or accessories may be appropriate. Examples include the following:

3.5.1 Internal Wash Down System

Construct PVC schedule 80 piping using all PVC wide-angle solid cone nozzles with overlapping sprays. The piping should be designed for connection of cold water service from either side of the fume hood. Provide an adequate

number of control valves and nozzles for effective coverage of the entire wash down area. An integral drain trough is also required across the rear of the fume hood, with a 1% slope to a 38 mm drain and a 76 mm long tailpiece. The trough should be integral with the work surface. Welds should be finished smooth and polished.

3.5.2 Scrubber System

This is often associated with an internal wash down system. It should be used when it is necessary to clean the exhaust air before it is discharged into the environment. Provide an internal effluent scrubber and eliminator unit consisting of spray nozzles of acid-corrosion resistant material. The scrubber system should be installed in the fume hood exhaust duct, preferably in close proximity to the fume hood, to minimize the length of ductwork exposed to chemicals. Hang the scrubber from the structure above so that parts requiring service are easily accessible. Provide a manual valve at the fume cabinet to initiate the wash down and effluent scrubbing process. The scrubber should operate continuously while the process is underway. The pressure drop across the scrubber should not exceed 250 Pa at the fume hood design air flow.

The reservoir, pump, and associated piping system should be installed in an acoustically insulated enclosure. The base furniture may be used for this purpose if designed as an integral part of the fume hood.

Neutralizing agents should be incorporated into the design based on the work processes and as required by the laboratory director.

The controls should consist of **RED** and **GREEN** lights to indicate whether the wash down/scrubber system is **OFF** or **ON**, respectively.

Scrubber efficiency tests should be performed by an independent testing laboratory at maximum exhaust air flow rate. The tests should demonstrate the efficiency in terms of the ratio of mass aerosols recovered versus the mass aerosols leaving the fume hood for the appropriate micron size.

Because scrubber efficiency varies with the test method used, test procedures must be fully documented so that future tests may be accurately duplicated.

All test results must be recorded on an approved performance verification (PV) report form together with the certificate of test submitted to the project manager. These documents must be included in the Building Management Manual.

3.5.3 Drain Trough

When required, the drain trough should be integral to and flush with the work surface. It should be located at the rear of the hood, with 1% slope toward a drain outlet. Welds should be finished smooth and polished. The trough should include a 38 mm drain fitting with integral debris catch and a 76 mm-long tailpiece.

3.5.4 Heat Shields

Heat shields should be installed where it is necessary to protect interior panels from radiant heat. They should be easily removable for cleaning purposes and should not compromise the safe operation of the fume hood.

3.5.5 Vapour Warning System

This should be installed for use with volatile and flammable chemicals when required by the project brief. Sensitivity should suit specific requirements.

3.5.6 Filters

Filters, including carbon filters, should be selected according to the type of contaminant to be captured and removed. Selection should be based on the efficiency required, the residence time required for the removal of the contaminant, and accessibility for inspection and replacement.

3.5.7 Fire Control

Only if deemed necessary, automatic fire protection within a fume hood should be provided in compliance with *NFPA 45: Standard on Fire Protection for Laboratories Using Chemicals*.

3.6 Laboratory Services to Laboratory Fume Hoods

3.6.1 Electrical

Provide a duplex receptacle: 120 volt, 20 amp, GFI, hospital-grade receptacle, mounted in the side post. Electrical service to each fume hood should be on a dedicated electrical circuit. The receptacle should be flush-mounted in a weatherproof box in the side post of the fume hood.

3.6.2 Plumbing Services

Provide remote controlled isolating valves located within the end panels, controlled by handles projecting through the side-posts of the fume hood. These or any other remote controls installed on the side posts should be located to avoid any interference with the smooth entry of air into the fume hood.

3.6.3 Fixtures

Fixtures, except for de-ionized and RO (reverse osmosis) water, exposed within the hood are to have a chemical-resistant metallic bronze finish, and portions exposed on the exterior of the fume hood are to be chrome-plated.

De-ionized and RO water faucets should be polyvinyl corrosion-resistant finish with polyoxymethylene lining, and stainless steel valves. Faucets must be aligned with the cup sink to prevent overspray and wetting of interior hood surfaces.

Colour coding and identification of service fixtures should be according to the standard of the laboratory facility, or as suggested in [Table 3-1](#) below. It can be modified if required to meet local conventions.

Table 3-1: Colour Coding and Identification of Service Fixtures

Service	Letter Coding (English)	Letter Coding (French)	Colour Coding
Cold Water	CW	EF	Green
Hot Water	HW	EC	Red
Distilled Water	DIW	ED	White
De-ionized Water	DEW	EDI	White
RO Water	ROW	EOI	White
Vacuum	VAC	VAC	Yellow
Compressed Air	AIR	AIR	Orange
Propane	PRO	PRO	Yellow-Orange
Natural Gas	NG	GN	Yellow-Orange
Oxygen	OXY	OXY	Green
Nitrogen	N	AZ	Blue
Argon	A	AR	White
Steam	ST	VAP	Black

3.6.4 Cup Sinks

Cup sinks should be raised above the recessed work surface to prevent spills from entering the plumbing system. Welds should be finished smooth and polished. Include a 38 mm drainpipe with integral debris catch and a 76 mm-long tailpiece.

3.6.5 Access to Services

Cut-outs for plumbing and electrical services and fitments are to be made in the manufacturer's plant. Provide five cut-outs per side post. Unused openings in exterior panels for service connections should be complete with cap plugs of the same material as exterior panels.

Service connections should be accessible from the outside of the fume hood, using removable panels. Isolating valves must be provided on the building side of the services.

Where two or more hoods are installed side by side, interior service panels may be used.

They should be of the same material as the interior panels, have bevelled edges and moulded PVC gasket, and should be secured by non-corrosive fasteners set flush with the face of the panel.

3.7 Integration with Room HVAC and Exhaust Systems

Fume hood exhaust systems must be fully integrated with the heating, ventilation and air conditioning (HVAC) system of the laboratory and the building automation systems (BAS), to maintain the pressurization requirements of the laboratory and the required fume hood performance. See [Chapter 5: Fume Hood Tests Integral with Commissioning Efforts](#).

3.8 Definition of Fume Hood Operating Modes

Caution must be exercised at every individual laboratory facility to ensure that the HVAC sequence of operations correctly addresses the various possible fume hood operating modes. For instance, with a bypass hood in a situation where two-position air flow is achievable, it would be appropriate to define both a **standard operating mode** and a **standby mode**. *Standby mode* would be applicable for the fume hood at times when there are **NO** processes involving generation of contaminants. This mode is activated by the user via a switch on the fume hood or on the fume hood monitor, and the exhaust box or the individual fume hood exhaust fan switches to a lower level of ventilation. In such a situation, the monitor's red indicator light would signal that the hood is unsafe to use, as only minimal air flow would be occurring through the fume hood. The sash should be closed at such time.

For **standard operating mode**, the assumption is that the hood has contaminant-generating processes occurring (either attended or not) and that adequate face velocity is achieved, as indicated by the green indicator light on the fume hood monitor.

To further break down the operating modes for any fume hood, consider the following possible fume hood activities:

1. Occupied—In use: Generation of hazardous products occurring.
2. Occupied—Not in use (set up): Experimental apparatus being assembled in the fume hood.
3. Unoccupied—In use (unattended procedures): Generation of hazardous products occurring. Minimal air flow permitted. Sash closed.
4. Unoccupied—Not in use (storage): No active generation of hazardous products. Minimal air flow permitted. Sash closed.

These fume hood operating modes should not be confused with laboratory occupied and unoccupied modes of operation, as they will not necessarily coincide.

3.9 Fume Hood Operation, Controls, and Alarms

Fume hood exhaust systems are an integral part of the laboratory HVAC system. However, improper integration poses possible dangers and should be studied carefully during the design development stage of the project.

3.9.1 Fume Hoods with Dedicated Exhaust Fan

1. Exhaust fan operation: Manual control (on/off switch) should be flush-mounted in a weatherproof box in the exterior panel. Clearly label the switch as "**CAUTION: FUME HOOD OPERATION DISCONNECT SWITCH,**" and provide a protective cover.
2. Fume hood exhaust fan should not be turned off unless the hood has been decommissioned and/or for service procedures.
3. Monitor should include a **GREEN** light to indicate **POWER ON** and **SAFE TO OPERATE** conditions for the fume hood system.
4. Audible and visual alarms: Provide audible (horn, buzzer, or bell) and visual (**RED** light) alarms to indicate air velocity is outside the acceptable range.

5. Fume hoods should be used only if **ALL** safety controls are satisfied.
6. The audible portion of the alarm can be overridden by pressing a silencing relay switch, but the red light is to remain on until the **ABNORMAL** air velocity condition is rectified. The alarm system will automatically reset when all safety conditions are met.
7. Heater controls (when a heater is used in the fume hood) should be integrated into the fume hood control system.
8. The fume hood, its controls, and alarms are to be ULC-labelled.
9. The user should be able to verify the functioning of all operating controls and alarms.
10. Complete operating instructions for the alarm system should be secured to the fume hood.
11. The fume hood should be interlocked with the HVAC and fume hood exhaust system, except that the fume hood exhaust fan should not be interlocked to automatically shut down when the building fire alarm system is in alarm.

Note: Standard Operating Procedures regarding fume hood operation are required to be developed for laboratories in which the HVAC switches to an “unoccupied” mode during silent hours. Sash management compliance must also form part of the procedures.

3.9.2 Dual-Speed Exhaust Fan Control System

If incorporated into the HVAC and fume hood exhaust system design, it should operate on **HIGH** speed when the fume hood is in use. This condition should be indicated by a **GREEN** light to indicate **FUME HOOD READY FOR USE** and a **RED** light to indicate **FUME HOOD UNSAFE FOR USE**. For further information refer to [Appendix D](#).

3.9.3 Manifold Fume Hood Exhaust System

This should be as described under [Section 3.9.1: Fume Hoods with Dedicated Exhaust Fan](#) except that no local control of exhaust fans is permitted. Instead, building automation systems (BAS) control of fume hood exhaust terminals is required.

3.9.4 Connection to Emergency Power

The requirement for the connection of the laboratory fume hood alarm/monitor and the fume hood exhaust fan to an emergency power source should be identified by the laboratory director based on program requirements. Such connections should conform to the requirements of *CAN/CSA Z316.5: Fume Hoods and Associated Exhaust Systems*.

For manifold systems, at least one of the exhaust fans should be on emergency power, where exhaust system function must be maintained.

3.10 Base Furniture

Unless the fume hood is of the floor-mounted variety, base furniture may be of any sort, so long as it does not interfere with air entry below the lower (sill) airfoil. Base furniture is **NOT** part of the laboratory fume hood.

Note: Within base furniture there is often a flammable storage cabinet. Such units, if ventilated, should be ventilated separately from the fume hood and should not be connected to the fume hood exhaust system. See *NFPA 30: Flammable and Combustible Liquids Code, 2012*.

3.11 Noise Levels

Fume hood decibel level should not exceed 70 dBA measured at the working position of the fume hood user. This is a design criterion that the design team should address during design. If it is an area of concern, a noise level test should be specified under testing, adjustment, and balancing (TAB) for new fume hoods.

The design team should consider design elements such as flexible couplings, vibration isolator, fan speed, installation of system assembly, and location of exhaust fan to reduce noise level.

3.12 Governing Standards

All relevant standards and references are listed in [Bibliography](#).

This guideline, *MD 15128*, should be used to establish **performance criteria** for fume hood acceptance.

3.13 Tests

Performance criteria and test procedures for laboratory fume hood tests are described in [Chapter 6: Fume Hood Performance and Testing Requirements](#).

With the exception of those specifically outlined herein, the **performance test procedures** should be as described in the most recent version of *ANSI/ASHRAE 110: Method of Testing Performance of Laboratory Fume Hoods*.

CHAPTER 4

FUME HOODS AND LABORATORY LAYOUT

4.1 Laboratory Layout, Fume Hood Locations, and Fume Hood Performance

Laboratory fume hood performance is greatly affected by the direction and velocity of the room air in the vicinity of the fume hood, turbulence of air in the vicinity of the fume hood, the arrangement of laboratory furniture, the movement of personnel within the laboratory, and many other factors listed in [Chapter 6: Fume Hood Performance and Testing Requirements](#).

This is because a 0.5 m/s face velocity is a very low velocity, which can be easily affected by external influences. For instance, a person walking at a leisurely pace will be travelling at a minimum of 1.5 m/s, and the wake that trails a person walking at this speed can easily pull contaminants from a fume hood. Consequently,

1. Fume hoods should be located in areas of minimum turbulence.
2. Fume hoods should be at least 2.4 m from entrances into the laboratory.
3. Fume hoods should not be located in high-traffic areas.
4. The sidewall of fume hoods should be at least 300 mm away from any wall to ensure that air flow is uniform across the face of the fume hood.
5. There should be at least 1.5 m spacing between fume hoods facing each other. Where there is a need to lessen this distance, a specific test protocol is to be written in order to measure fume hood performance. In this instance, and with oversize or differing types of hoods in close proximity to one another, mock-up testing is required to confirm acceptable performance.
6. There should be at least 1 m distance from the face of a fume hood to the nearest item of furniture, and 1.5 m to the nearest opposite wall or other obstruction taller than the work surface height.

4.2 Locating Supply Air Diffusers with Respect to Fume Hoods

The hood density, or number of fume hoods, that can be placed within a laboratory space is constrained by several factors, including the following:

1. Distance between fume hoods and air diffusers
2. Physical size of the fume hoods
3. Available ceiling space for the installation of supply diffusers
4. Type of air diffuser and discharge characteristics

These factors will affect the performance of laboratory fume hoods and must be considered together to alleviate potential problems. Historical data indicates that locating properly sized diffusers at least 1.5 m from laboratory fume hoods reduces hood turbulence due to cross drafts and variations in air supply temperature. The distance of 1.5 m from the front and sides of the fume hood defines a zone (No Diffuser Zone, NDZ). Placement of any diffuser within the NDZ should be avoided unless the diffuser is required for room air circulation and air supply from the diffuser does not impact fume hood performance. High velocity diffusers should be avoided near laboratory fume hoods.

When the placement of diffusers is close to the NDZ, certain locations near the hood may be preferred, as shown in the figure below. Three zones are identified surrounding the NDZ. Diffuser Zone 3 is a good location for locating a supply diffuser, Diffuser Zone 2 is a better location, and Diffuser Zone 1 is the best location. Lab designers should use caution when locating diffusers in Zone 3 in front of a hood opening, as air directed perpendicular to the plane of the sash can be more detrimental to hood performance than cross drafts from other directions.

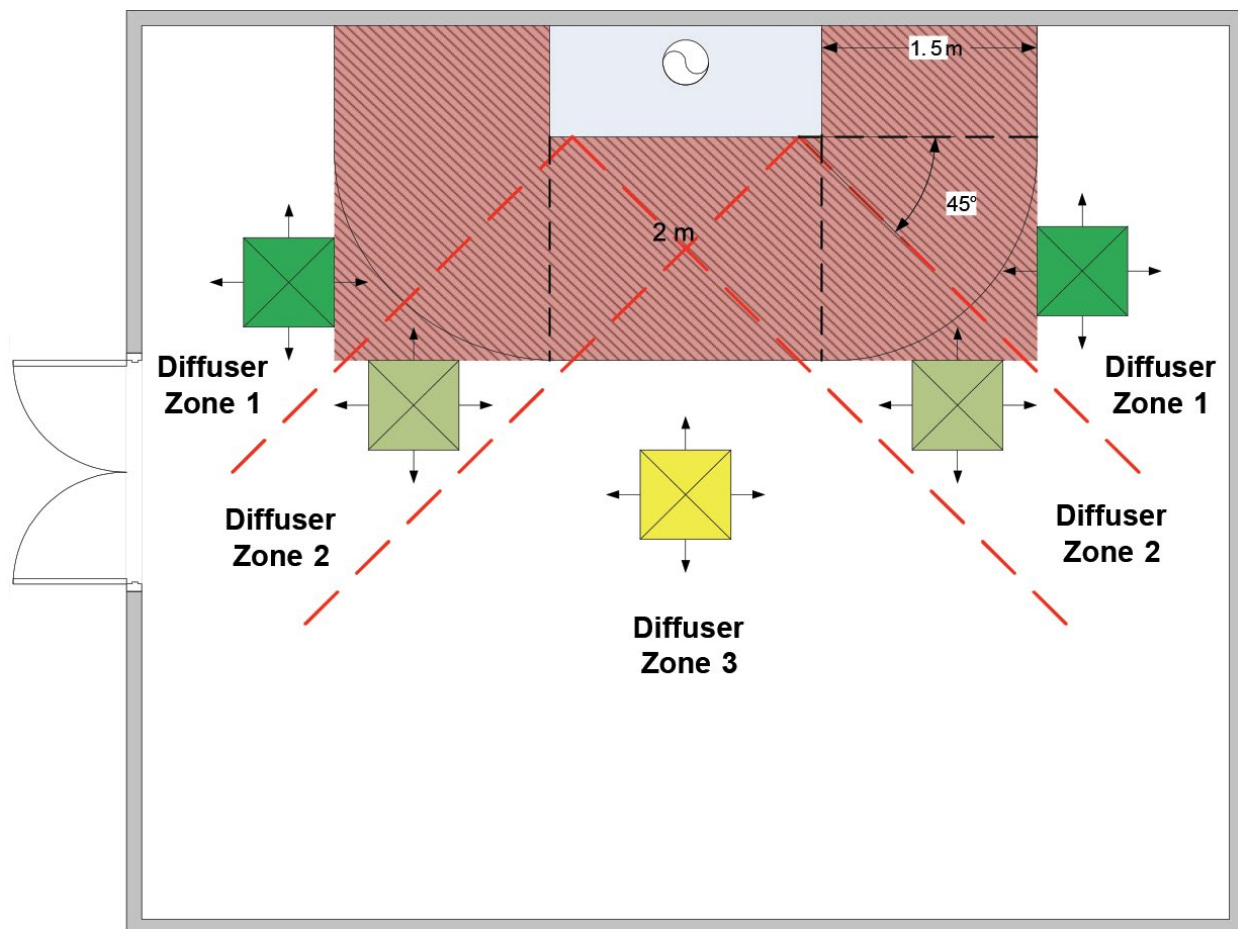

Figure 4-1: Diagram Showing Good, Better, and Best Locations for Supply Diffusers with Respect to Hood Opening

4.3 Exit Routes from the Laboratory

There shall be good exit capability, which cannot be blocked in the event of an accident at a fume hood. Ideally, two exit routes should be provided. Depending upon the laboratory size and layout, more than two exits may be required.

CHAPTER 5

FUME HOOD TESTS INTEGRAL WITH COMMISSIONING EFFORTS

5.1 General

Fume hoods are rarely a standalone piece of equipment, isolated from the operation of the remainder of the laboratory. Rather, they must function in concert with other HVAC components, seamlessly integrated with supply air, exhaust air, and static pressure settings whether in steady state or dynamic modes (see [Figure 5-1](#)).

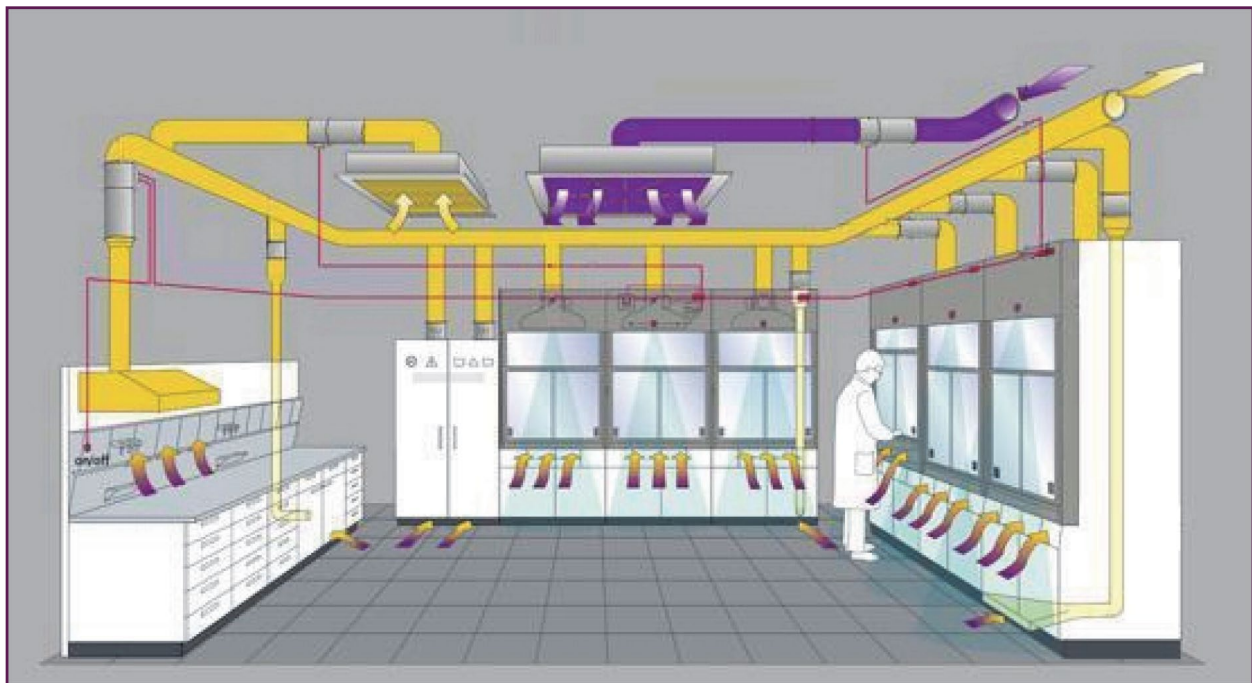

Figure 5-1: Schematic to Illustrate Relationship Between Fume Hood(s) and Lab Ventilation

As a result, fume hood testing will often require the timely intervention of other subcontractors who are involved in the commissioning of the laboratory. The chart below reflects the involvement of all parties from the point at which fume hoods are first specified through to their final on-site testing.

Consider the following applications in which we wish to perform fume hood tests:

5.2 New Fume Hoods Installed in New or Renovated Laboratory

When commissioning has reached the integrated testing stage, cooperation is required between the general contractor (GC), fume hood manufacturer's representative, TAB subcontractor, BAS controls subcontractor, and the fume hood testing agent in order to systematically proceed with all fume hood tests. Under the direction of the design engineer, **there will often be several "test, adjust, re-test" efforts** in order to balance the system, calibrate components, fine-tune face velocity, achieve acceptable speed of response, etc., as required to meet all of the fume hood performance criteria.

Substantial completion of such a project will sometimes include a 30-day break-in period to "exercise" the lab HVAC and fume hoods, hopefully verifying consistent performance prior to being employed in a program of research.

In a non-renovated existing laboratory, replacement of older fume hoods with current models will often be associated with new controls strategy, energy savings objectives, possibly exhaust manifold, and so on. As a result, a multi-party commissioning effort as described above may also be necessary as part of such fume hood testing.

5.3 Existing Fume Hoods Due for Annual Testing

Prior to initiating fume hood tests, the BAS should be checked for its fume hood alarms history and for confirmation that the lab is consistently performing within its control strategy parameters.

In the best case scenario, a well-functioning HVAC system will have performed in a stable manner since the previous annual tests. In this case, face velocity measurements will indicate that readings are more or less unchanged from the previous year. However, if significant changes to face velocity readings are noted, then additional fume hood tests must be suspended until a cause and remedy are determined by the supervising facility manager and/or design engineer.

Similarly, if any of the other tests arrive at "out of range" results, corrective action will be required before testing can be successfully completed.

Table 5-1: Cooperative Efforts in the Purchase, Installation, and Testing of Fume Hoods

Purchase, and Manufacturer's Tests

Tasks	Project Authority	Engineer	Commission Agent	General Contractor	Fume Hood Manufacturer	Fume Hood Tester	TAB Sub-contractor	BAS Sub-contractor	HVAC Sub-contractor	Plumbing and Electrical Subs
Edit National Master Specification section to specify fume hood		X								
Place order for fume hoods	X			X	X					
Shop drawing submittal and review/approval	X	X		X	X					
Factory tests	Witness				X	X				
Review and approve test report	X		X		X	X				

Installation

Tasks	Project Authority	Engineer	Commission Agent	General Contractor	Fume Hood Manufacturer	Fume Hood Tester	TAB Sub-contractor	BAS Sub-contractor	HVAC Sub-contractor	Plumbing and Electrical Subs
On Arrival Acceptance			X	X						
Fume Hood place and hook-up				X	X			X	X	X
Lab HVAC systems fully commissioned*	X	X	X	X			X	X	X	
Fume hood controls and BAS initial setup					X			X		
Fine-tune balance and face velocity						X	X	X		

* "[...] includes calibration of airflow controls, calibration of automatic temperature controls, balance of air supply, completion of a duct traverse on the exhaust duct, [...] and completion of an air balance of the total exhaust flow." (ASHRAE 110)

Table 5-1: Cooperative Efforts in the Purchase, Installation, and Testing of Fume Hoods (cont'd)

On Site Tests—New Fume Hoods

Tasks	Project Authority	Engineer	Commission Agent	General Contractor	Fume Hood Manufacturer	Fume Hood Tester	TAB Sub-contractor	BAS Sub-contractor	HVAC Sub-contractor	Plumbing and Electrical Subs
Cross-draft tests						X				
If necessary, correct cross draft		X		X						
Calibrate fume hood monitor						X	X	X		
Complete array of tests in MD 15128			X			X				
Submit test report				X		X				
Review and approve test report	X	X	X							

Annual Tests

Tasks	Project Authority	Engineer	Commission Agent	General Contractor	Fume Hood Manufacturer	Fume Hood Tester	TAB Sub-contractor	BAS Sub-contractor	HVAC Sub-contractor	Plumbing and Electrical Subs
Cross-draft tests						X				
If necessary, correct cross draft		X		X						
Complete array of tests in MD 15128	X					X				
Approve report	X									

CHAPTER 6

FUME HOOD PERFORMANCE AND TESTING REQUIREMENTS

6.1 Fume Hood Performance

In terms of containment capability, fume hood performance may be defined as a measure of the amount of spillage and the potential for exposure of the user to airborne hazards generated within the hood. It can only be effectively evaluated through performance tests by the manufacturer and, subsequently, by on-site tests.

Fume hood face velocity is not the sole criteria by which containment is measured. Several other tests found within this chapter are essential in confirming performance (see [Section 6.3: PWGSC Performance Criteria](#)).

The fume hood is only one part of a system that includes the fume hood exhaust system, general exhaust, air supply system, and laboratory design. Many factors affect hood performance, including the following:

1. Design of the fume hood
2. Design of the laboratory
3. Design and operation of the ventilation systems
4. Design and operation of the fume hood exhaust systems
5. Position of baffles and the size of the slots
6. The sash position and opening area
7. Magnitude, distribution, and turbulence of face velocity
8. Location of apparatus within the fume hood
9. Turbulence within the fume hood
10. Location of the user relative to the front of the fume hood
11. User work practices, including arm motions of the user
12. Room air flow patterns in the vicinity of the fume hood (typically influenced by the type and location of supply diffusers)
13. Fume hood location
14. Adjacent doors
15. Adjacent people traffic
16. The effect of heat-generating apparatus within the fume hood

6.2 Qualifications of Testing Agent

Testing of laboratory fume hoods should be performed by a qualified, independent testing agency that has proven experience in this type of work. Qualification requirements should be as stated in the project brief, and proof of qualifications should be submitted to the project manager and the laboratory director. The project manager reserves the right to accept or reject the proposed testing agency.

PWGSC recommends the following qualification criteria for contractors or in-house test agents:

1. Minimum 3 years of experience in the testing of fume hoods
2. Attended a *HVAC Systems and Laboratory Design* course (by U.S. Eagleson Institute, or equivalent)
3. Attended *ASHRAE 110: Testing Workshop* training (by U.S. Eagleson Institute), or *Fume Hood Testing Seminar for Certified Professionals* (by National Environmental Balancing Bureau (NEBB), or equivalent)
4. Fully cognizant of contents of *MD 15128: Laboratory Fume Hoods*

A form to be completed and signed by the proposed testing agent verifying his/her qualifications can be found in [Appendix C.5: Statement of Conformance](#).

6.3 PWGSC Performance Criteria

The performance criteria found in Table 6-1 to Table 6-6 are readily achievable by a well-designed fume hood operating in a laboratory that has been successfully commissioned. As such, PWGSC offers these values as reasonable pass/fail determinants in assessing fume hood test results. To achieve a “pass” result, the fume hood must perform to the recommended level for each and every applicable test found in Table 6-1 to Table 6-6. For an existing installation, the ultimate decision regarding continued use of fume hoods that fail to meet one or more of these recommended criteria rests strictly with the laboratory director.

Test procedures can be found in [Section 6.9: Test Procedures](#).

The values shown in Table 6-1 to Table 6-6 are generic and **should not be interpreted as providing safe exposure levels for all processes**. If in doubt, use an application-specific hazard analysis of the chemicals and processes involved to determine safe exposure levels.

Note to Laboratory Directors: The values shown in this table should be considered as PWGSC minimum requirements. If warranted, consult the A.C.G.I.H. References listed in Bibliography, and undertake a thorough analysis to determine whether more stringent performance criteria should be required.

Table 6-1: Cross Draft Tests

	As Manufactured	On Site (As Installed/As Used)
Cross drafts measured 1.5 m above floor level and 0.5 m from hood; test with sash at normal operating position.	Challenge fume hood performance: During all tests in Tables 6-2, 6-3, 6-4, and 6-5, create a single 0.25 m/s cross draft, directed horizontally, 45 degrees incident to the plane of the sash.	<ul style="list-style-type: none"> • New fume hoods in new/refitted lab: Average value less than or equal to 0.15 m/s • Existing fume hoods: Average value less than 0.25 m/s

Table 6-2: Velocity and Flow Tests**CAV Bypass Fume Hoods**

		As Manufactured	On Site (As Installed/As Used)
Face velocity: At design sash position	Average of all readings	0.5 m/s \pm 0.01 m/s	0.5 m/s \pm 0.02 m/s
	Variation allowed for individual readings	\pm 20% of average	\pm 20% of average
Bypass effectiveness	Ave. face vel. at 150 mm sash opening	< 1.25 m/s	< 1.25 m/s

High Performance Fume Hoods

		As Manufactured	On Site (As Installed/As Used)
Face velocity	Average	0.3 m/s \pm 0.01 m/s	0.35 m/s \pm 0.02 m/s
	Variation allowed for individual readings	\pm 0.05 m/s	No reading less than 0.25 m/s

Table 6-2: Velocity and Flow Tests (cont'd)**VAV Fume Hoods**

		As Manufactured	On Site (As Installed/As Used)
Face velocity: At design sash position	Average	0.5 m/s ± 0.01 m/s	0.5 m/s ± 0.02 m/s
	Variation allowed for individual readings	± 20% of average	± 20% of average
Face velocity: Sash at 66% (in height) of design sash position	Average	0.5 m/s ± 0.05 m/s	0.5 m/s ± 0.05 m/s
	Variation allowed for individual readings	± 20% of average	± 20% of average
Face velocity: Sash at 33% (in height) of design sash position	Average	0.5 m/s ± 0.05 m/s	0.5 m/s ± 0.05 m/s
	Variation allowed for individual readings	± 20% of average	± 20% of average
Flow response	VAV speed of response: time to reach 90% of the average steady-state value	Within 3 seconds of initial sash movement	Within 3 seconds of initial sash movement
	VAV time to steady state: return to ± 10% of avg. face velocity or flow	Within 5 seconds of initial sash movement	Within 5 seconds of initial sash movement
Minimum flow per ANSI Z9.5	Sash lowered completely	Capable of maintaining 150 to 375 air changes per hour	Capable of maintaining 150 to 375 air changes per hour

Table 6-3: Smoke Visualization Performance Criteria

Use smoke generation equipment, smoke diffuser, and diffuser locations, all as described in [Appendix A: Smoke Visualization Test Protocol](#).

Rating	Initial Observation		Final Observation
Pass	High	Smoke discharged from the diffuser is not observed within 150 mm of sash plane.	The hood receives a High Pass rating.
	Low	Smoke discharged from the diffuser is observed within 150 mm of sash plane, but is not observed outside the plane of the sash.	The hood receives a Low Pass rating.
Fail	Low	Smoke discharged from the diffuser is observed as an intermittent escape outside the plane of the sash. This occurrence automatically is assigned a Low Fail rating and requires two additional tests be conducted at this location to confirm escape.	If the observations during the 2 nd or 3 rd tests indicate repeated escape beyond the plane of the sash, the rating of Low Fail remains. If there is no indication of repeated escape, the test receives a Low Pass rating.
	High	Smoke discharged from the diffuser is observed continuously escaping outside the plane of the sash, or intermittently beyond the plane of the sash and into the room.	The hood receives a High Fail rating.

Table 6-4: Tracer Gas Tests**All CAV, VAV, and high performance fume hoods**

		As Manufactured*	On Site (As Installed/As Used)
Tracer gas—static sash position	Design sash position	Ave. < 0.025 ppm Peak < 0.100 ppm	Ave. < 0.05 ppm Peak < 0.25 ppm
	Sash fully open	Ave. < 0.05 ppm Peak < 0.25 ppm	On a project-specific basis, designers to determine the need for fully open sash testing (not for CAV hoods)
Peripheral scan, design sash position	Record all detectable concentrations and their locations; record 30-second rolling averages	Include in test report. Seek approval from project authority	Include in test report. Seek approval from project authority
Sash movement effect	Maximum 45-second rolling average	< 0.05 ppm	< 0.05 ppm

*Testing to be done at target average face velocity and at $\pm 20\%$ of target face velocity in manufacturer's tests.

Table 6-5: Additional Required Tests

		As Manufactured	On Site	
			As Installed	As Used (Project Specific only)
Simulated experimental apparatus placed within fume hood (adjust setup to fit fume hood size) Repeat all velocity, visualization, and tracer gas tests		Record results in test report	Not required	<i>If deemed necessary, put actual lab apparatus in place.</i>
Fume hood monitor and alarm	Monitor accuracy (3-point calibration required)	Accurate within 5% of average face velocity or flow		
	Alarm enunciation (both audible and visual)	If flow is high or low by 10% as compared to design set point		
	Alarm response: Max. enunciation delay	10 seconds		
Hood static pressure at design sash position and 0.5 m/s face velocity (or 0.35 m/s for high performance hood)		< 62 Pa		
Noise level: at working position in front of fume hood		< 70 dBA		

Table 6-6: Test Equipment Specifications

Parameter	Equipment	Specifications
All	Data Logger (multi-channel)	Speed: Minimum 0.5 seconds Memory: Minimum 900 data points, and sufficient to allow data collection for the duration of the test
Flow Response	In-duct Flow Sensor	Range: 95 to 950 l/s Accuracy: $\pm 5\%$
Velocity	Thermal Anemometer	Range: 0.25 to 2.0 m/s Accuracy: Below 0.50 m/s: ± 0.025 m/s 0.50 m/s and above: $\pm 5\%$ Time Constant: For face velocity: 20 seconds For VAV tests: Max. 1 second
Tracer Gas Containment	Detector	Type: Continuous reading Minimum Range: 0.01 to 100 ppm Accuracy: Concentrations 0.05 to 0.1 ppm: $\pm 25\%$ Concentrations above 0.1 ppm: $\pm 10\%$

Note: Tests require digital collection of data.

6.4 Tests at the Manufacturer's Facility

The following requirements of the fume hood manufacturer should form part of the purchase specifications:

1. The fume hood manufacturer should maintain a testing facility at its place of business for conducting tests using procedures described herein, and with the capability of demonstrating compliance to the performance requirements of Table 6-1 to Table 6-6 shown above. For instance, the manufacturer's ventilation system should be capable of adjustment over a range of supply and exhaust flows, including changes in temperature and area pressurization to provide thorough "AM" challenges.
2. Performance tests should be verified by an independent test agency at the manufacturer's facility.
3. The manufacturer should submit performance test results to confirm that specified performance criteria for the most current design of fume hood have been met. The manufacturer should also provide a performance envelope that clearly indicates failure points for exhaust flow and face velocity.
4. The test equipment should meet specifications as called for in *ANSI Z9.5* or those noted in [Table 6-6](#), whichever is most stringent.
5. PWGSC should reserve the right to witness "AM" tests and be notified at least two weeks prior to the start of testing.
6. Prior to issuance of a purchase order or shipping, the manufacturer shall provide the factory performance test report and shall then seek approval from PWGSC (or the project authority).
7. If controls do not form part of the laboratory fume hood specifications, the controls manufacturer should transport the controls to the fume hood manufacturing plant, where they are to be installed and calibrated to function as specified. Coordination of this activity is to be the responsibility of the general contractor.

Tests at the manufacturer's facility must include performance tests with the hood empty and with the hood loaded to simulate experimental apparatus in the hood (see [Section 6.9.6.1: As Manufactured Simulated Apparatus](#)).

6.5 On-Site Tests

6.5.1 On Arrival Acceptance

Prior to installation, verification of the fume hood as meeting the design specifications is required. Each hood is to be "proved" in the field to demonstrate that the unit is consistent with the prototype and shop drawings, has not been damaged in shipping, and bears a CSA approval. Use a component verification check sheet ([Appendix C: On-Site Test Forms](#)) to document this stage of verification. This check sheet should be signed by both the contractor and the designer before the fume hood is installed.

6.5.2 As Installed ("AI") Tests

6.5.2.1 Equipment and Procedures

1. Once installed, test each fume hood using the procedures of [Section 6.9: Test Procedures](#) to ensure that fume hood performance remains within the design criteria.
2. Performance tests should be conducted by an independent testing agency approved by the project manager. It is recommended that a representative from the fume hood manufacturer be on-site to verify the new installation before performance testing.
3. Test for all "AI" performance criteria called for in Table 6-1 to Table 6-5.
4. Tests should be performed with the fume hood empty and with the sash at its design position.
5. In demonstrating compliance with Tables 6-1 to 6-5, documented tests results should include verification of all controls and alarms to confirm the following:
 - a. Confirm calibration of all associated sensors
 - b. Accuracy and response of alarms.

6.5.2.2 Integrated Systems Tests

1. The testing of fume hoods should only be performed under the following conditions:
 - a. After the entire laboratory HVAC and exhaust system has been properly tested, adjusted and balanced (TAB) and all TAB and performance verification (PV) reports have been accepted;
 - b. After all HVAC and exhaust systems are in full operation
 - c. The room temperature should be maintained between 22 °C and 24.5 °C and should be recorded on the documentation to be submitted.
 - d. As part of the commissioning of all integrated HVAC and exhaust systems and laboratory space pressurization tests identified in the project specifications.
2. See [Chapter 5: Fume Hood Tests Integral with Commissioning Efforts](#).

Note: Deviation of space pressurization due to lab door opening and closing, change of lab operating modes, upset conditions, etc., could affect fume hood performance.

6.5.2.3 Cross Draft Testing

Air currents external to the hood can be problematic, and should be measured. Cross drafts should be controlled so as to limit the impact on fume hood containment. (see [Section 6.9.1: Cross Draft Test Procedures](#))

6.5.2.4 CAV Fume Hood Tests

CAV fume hood testing should commence only after cross draft testing has been completed, including corrective measures if required.

As described in [Section 6.9: Test Procedures](#), perform the following CAV fume hood tests:

1. Face velocity
2. Bypass effectiveness
3. Visualization
4. Tracer gas—design sash position
5. Tracer gas—peripheral scan
6. Tracer gas—sash movement effect
7. Monitor/alarm accuracy and enunciation
8. Static pressure drop
9. Noise level

6.5.2.5 VAV Fume Hood Tests

VAV fume hood testing should commence only after cross draft testing has been completed, including corrective measures if required.

As described in [Section 6.9: Test Procedures](#), perform the following VAV fume hood tests:

1. Face velocity
2. Flow response
3. Minimum flow
4. Visualization
5. Tracer gas—design sash position
6. Tracer gas—peripheral scan
7. Tracer gas—sash movement effect
8. Monitor/alarm accuracy and enunciation
9. Static pressure drop
10. Noise level

For VAV fume hoods, the *face velocity control*, *flow response*, and *tracer gas sash movement effect* tests can be conducted simultaneously, to save time and to provide direct correlation between flow variations and escape from the hood.

6.5.3 As Used (AU) Tests

The need for more stringent performance values than those listed in Table 6-1 to Table 6-5 should be determined by a laboratory-specific analysis of hazard and/or operational methods.

Where large experimental apparatus is used within the hood, *As Used* condition testing may be appropriate and warranted to ensure containment. Such testing will also provide the opportunity to instruct the user regarding minor adjustments to apparatus location, orientation, etc., in order to achieve optimum results.

6.5.4 Reports and Labelling

1. Certificates and test results must be placed in the O&M Manual.
2. A label shall be affixed to the front of the hood indicating its verification, name of the verification authority, and the date thereof.

6.5.5 Annual Tests for Existing Fume Hoods

All existing fume hoods should be tested to the extent indicated in [Table 6-7: Fume Hood Test Frequency](#) below for re-verification against the performance criteria found in Table 6-1 to Table 6-6.

The following procedures should precede these tests:

1. Where access allows, check the integrity of all seals around light fixtures, using a smoke pencil.
2. Check that the sash stop is still in place and operates properly.
3. Check that all baffles are in the same positions as in previous tests.

Table 6-7: Fume Hood Test Frequency

	Annually	Every 5 years
Cross drafts	X	
Face velocity	X	
CAV Bypass effectiveness	X	
VAV flow response	X	
VAV minimum flow	X	
Visualization	X	
Tracer gas—static sash position		All, or representative sample*
Tracer gas—peripheral scan		All, or representative sample*
Tracer gas—sash movement effect		All, or representative sample*
VAV response and stability	X	
Fume hood monitor/alarm	X	
Static pressure	X	
Noise levels	X	
Calibration of sensors connected to the building automation system (BAS)	X	

*Test all fume hoods, or at the discretion of the laboratory director test a minimum of 20% of the total number.

It is important to determine whether significant-sized laboratory equipment inside the hood is the same as for previous tests.

Note: While tracer gas testing is required for new installations, it is not required annually, as long as no changes in the HVAC system have occurred, and as long as face velocity values for each hood are found to be consistent with the previous year's readings.

6.6 Examination of Results on Re-Tests of Existing Fume Hoods

The results of all tests on existing fume hoods should be compared with the results of previous tests. A decline of 10% from the initial "*As Installed*" value of average face velocity is considered significant, and only non-hazardous work should be permitted within the hood until the variation has been diagnosed and repaired.

6.7 Recommended Test Sequences

The following sequences are recommended for the "*As Installed*" tests and "existing" fume hood tests. It may be necessary to rectify problems of excessive cross drafts before proceeding to face velocity and visualization tests:

1. Cross drafts test
2. Velocity and flow tests
3. Visualization tests
4. Tracer gas tests
5. Additional required tests

6.8. Coordination

All on-site testing programs must be coordinated with the Laboratory Director, including:

1. Establishing design sash position heights for each fume hood
2. Confirmation that smoke-generating devices are acceptable and will not affect the ongoing laboratory program
3. Acceptability of using tracer gas

6.9 Test Procedures

6.9.1 Cross Draft Test Procedures

6.9.1.1 As Manufactured

All velocity, visualization, and tracer gas "*As Manufactured*" tests should be performed under the influence of a cross draft, intended to mimic the potential air currents with a laboratory. Impose a cross draft of 0.25 m/s directed horizontally, 45 degrees incident to the plane of the sash. Create this velocity at a height of 1.5 m above floor level, and 0.5 m out from the sash of the fume hood.

6.9.1.2 On Site

The laboratory HVAC system in which the fume hood is being tested should be operational. Cross drafts result from the laboratory HVAC system and measurements are to be taken 0.5 m from the sash, 1.5 m above floor level, and at the centre, left, and right locations, as shown in [Figure 6-1: Cross Draft Testing](#). The data should be analyzed to determine the average and maximum velocity at each location. If cross drafts exceed the guideline, further testing should be postponed until they are reduced to acceptable levels.

1. Place sash at design position.
2. Place hot-wire anemometer(s) as shown below to capture vertical, horizontal, and perpendicular velocities.
3. Data log the velocities at one reading per second for a period of 20 seconds.

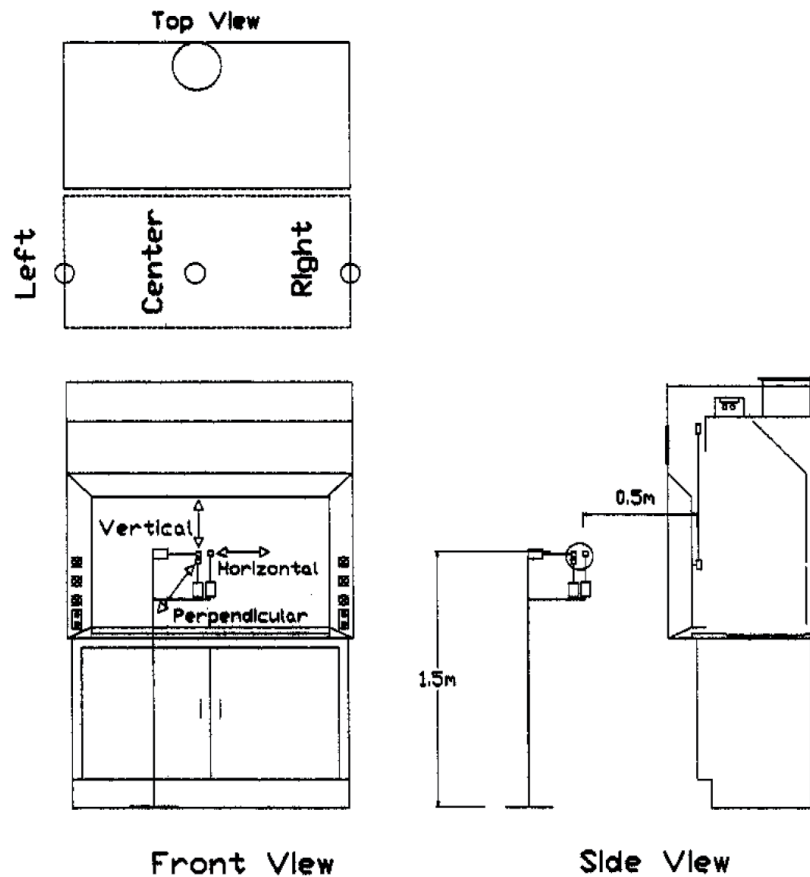

Figure 6-1: Cross Draft Testing

6.9.2 Face Velocity and Flow Test Procedures

6.9.2.1 Face Velocity

1. Using the dimensions of the sash opening (with sash at design position), create an imaginary grid composed of equal-sized rectangles, each with an area of no more than 0.09 m² and having the larger dimension of the rectangle not exceeding 330 mm in length.
2. With a hot-wire anemometer fixed to a moveable stand, place the probe within the plane of the sash, centered within each grid sequentially.
3. At one reading per second, measure the velocity for 20 seconds at each grid location. Calculate an average velocity at each location.
4. When measurements have been completed at all grid locations, calculate an average for that sash opening. Also note the high and low grid average from the complement of grid locations.

6.9.2.2 CAV Bypass Effectiveness

This test will confirm that excessive face velocities do not result from partial closure of the sash of a CAV hood.

1. Lower the sash from normal (design) position to 150 mm open.
2. Using face velocity measurement procedures of [Section 6.9.2.1: Face Velocity](#) determine the average face velocity.

6.9.2.3 VAV Face Velocity Control

This test is intended to confirm that the calibration of sash position versus exhaust valve movement is accurate over a range of sash positions. Face velocity measurements are taken using the procedures of [Section 6.9.2.1: Face Velocity](#).

1. With the sash at the design position, determine the average face velocity. Also note the high and low grid velocities.
2. With the sash closed to 66% of the design sash opening, determine the average face velocity. Note the high and low grid velocities.
3. With the sash closed to 33% of the design sash opening, determine the average face velocity. Note the high and low grid velocities.

6.9.2.4 VAV Flow Control

Dynamic VAV response tests are conducted to ensure that the VAV controls meet the criteria established in [Table 6-2: Velocity and Flow Tests](#) over a range of operating modes. The tests consist of measurement of flow while raising and lowering the sash.

The response and stability tests can be conducted by measuring exhaust flow directly using a flow sensor mounted in the duct, or by measuring slot velocity (see [Figure 6-2](#)).

Using slot velocity, flow response is determined by placing the tip of the velocity probe in the slot behind the baffle, where changes in slot velocity are directly proportional to changes in flow. The velocity probe is mounted in a secure stand with the probe located in the centre of the baffle slot opening. The velocity probe can be

oriented to measure air velocity entering the slot, or it can protrude through the slot to measure vertical plenum velocity. Slot velocity or flow is recorded at a rate of at least 10 Hz using a data acquisition system or data logger, while raising and lowering the sash.

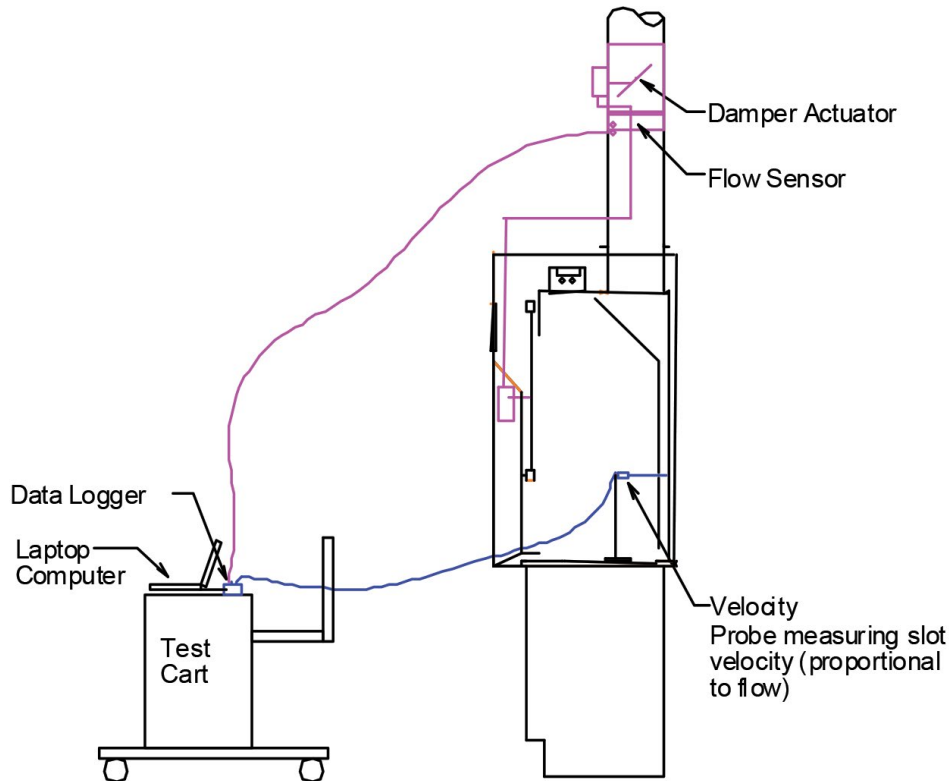

Figure 6-2: Simplified Diagram of Experimental Setup for VAV Response Test

Measurements are plotted while raising and lowering the sash three times during a 5-minute period. The sash is raised and lowered smoothly at a rate of approximately 0.5 m/s. The sash is in the closed position for 30 seconds and then at the design operating height for 60 seconds during each of three cycles.

Speed of Response is the time it takes from initial movement (opening) of the sash until flow reaches 90% of the eventual steady state value, as illustrated in [Figure 6-3](#) below.

Time to Steady State is the time it takes from initial movement (opening) of the sash until flow returns to (and remains) within $\pm 10\%$ of the eventual steady state, as illustrated in [Figure 6-3](#) below.

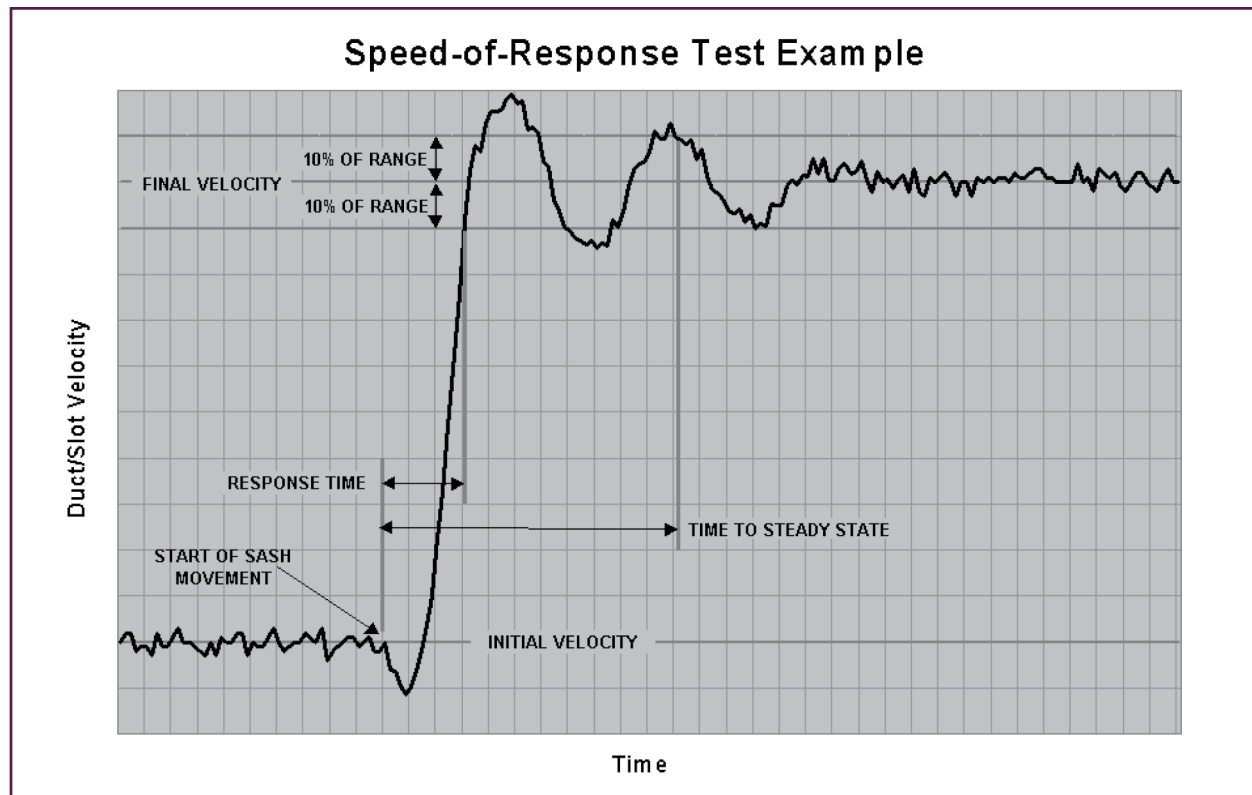

Figure 6-3: Speed of Response and Stability

6.9.2.5 VAV Fume Hood Minimum Flow

This test is intended to confirm that a VAV fume hood's airflow with the sash closed meets the minimum requirement of ANSI Z9.5.

1. Measure the fume hood internal width from interior side wall to interior side wall. Measure the fume hood depth from the plane of the sash to the surface of the rear baffle. Measure the fume hood internal height from the work surface to the highest point within the fume hood.
2. Using the internal dimensions of the fume hood, calculate the volume and thus the quantity of 1 air change. With this value, calculate the flow required to provide 375 air changes per hour (ACH).
3. Close the sash.
4. Compare the flow value provided by the BAS (i.e., the flow station at the exhaust control valve) to that of the calculated value of 375 ACH.

6.9.3 Smoke Visualization Test Procedures

Fume hoods must provide complete containment of the smoke generated within the hood, as the pass/fail ratings are noted in [Table 6-3](#). Smoke is generated using a consistent and replicable method, with the smoke-generation equipment, smoke diffuser, and diffuser locations all described in detail within [Appendix A](#).

1. Place diffuser at the prescribed location in the fume hood.
2. Position the sash(es) in the design sash position.

3. Set the smoke transfer fan speed to the operational volume setting.
4. Begin smoke generation at the prescribed set point and observe air flow patterns for 30 seconds while standing to the side of the sash opening, not closer than 300 mm to the plane of the sash.
5. Record observations.
6. Place a test mannequin with its imaginary breathing zone 75 mm outside the plane of the sash and directly in front of the smoke diffuser. Observe air flow patterns for 30 seconds.
7. Record observations.
8. Cease smoke generation and continue to observe smoke patterns within the hood and measure length of time to evacuate the visible residual smoke from the hood interior.
9. Record time to evacuate all visible smoke.
10. Evaluate the observations made during the smoke visualization test and assign the pass/fail rating as described below.
11. Record evaluation and rating results.
12. Following cessation of smoke generation and final observations, move diffuser to next test location and repeat steps 2-11.

After completing tests at all of the required smoke diffuser locations, turn off power to the smoke generator on the analog controller and set the smoke transfer fan speed to the purge volume setting (12 volts). Allow fan to operate for 2 minutes at the purge setting before turning off the transfer fan. This step will purge smoke from the generator, transfer hose, and diffuser.

6.9.3.1 Evaluation of Smoke Visualization Tests

Air flow patterns shall be observed and noted.

All of the smoke generated within the hood should be carried to the back of the hood and exhausted.

The following describes typical air flow problems as demonstrated by smoke visualization:

1. If the smoke moves forward toward the front of the hood, the air flow is described as “reverse flow.”
2. If the smoke remains on the work surface without smoothly flowing to the back baffle, the air flow is described as “lazy.”
3. If the smoke moves outside the plane of the sash, the observation of such is described as “escape.”

Reverse flow does not apply to the forward motion of the roll inside the hood that occurs in the upper cavity of the hood, above the vertical sash opening, or to the cyclonic motion behind a closed horizontal sash (reverse flow in areas at the top of the hood or behind the sash panels is called a vortex roll).

6.9.4 Tracer Gas Test Procedures

6.9.4.1 Mannequin Test

Use the equipment and procedures as described in *ANSI/ASHRAE 110-1995*, with the following exceptions:

1. For a fume hood with multiple sash panels, the *plane of the sash* reference location shall be the centreline of the sashes.
2. In positioning the tracer gas ejector within the hood, the surface of the ejector tube shall be no more than 150 mm from the plane of the sash.
3. 30 seconds after opening the tracer gas block valve, record readings at 1 per second for a period of 5 minutes.
4. Determine the average tracer gas concentration over the duration of the test.
5. Determine the peak concentration over the duration of the test.

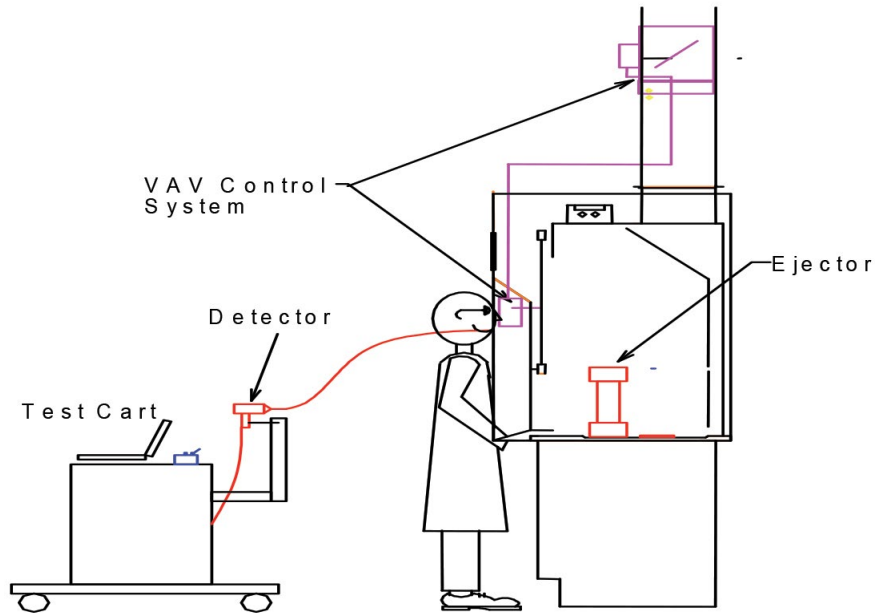

Figure 6-4: Mannequin and Ejector During Sash Movement Containment Tests

6.9.4.2 Peripheral Scan

Use the equipment and procedures as described in *ANSI/ASHRAE 110-1995*, with the following exceptions:

1. Scan 25 mm out from and in line with the periphery of the opening.
2. Record all detectable concentrations and their locations.
3. Record 30-second rolling averages.

6.9.4.3 Sash Movement Effect (SME)

Use the equipment and procedures as described in *ANSI/ASHRAE 110-1995*, with the following exceptions:

1. After the tracer gas block valve has been opened for 60 seconds, commence recording tracer gas concentrations.
2. After 60 seconds, open the sash to design position.
3. After 60 seconds, close the sash.
4. After 30 seconds, open the sash to design position.
5. Repeat opening and closing to obtain readings for three cycles.
6. Determine 45-second rolling averages for each of the three “sash open” periods.

The maximum of the three averages is the SME value.

6.9.5 Monitor/Alarm Test Procedure

Once a fume hood has been tested and found to meet performance criteria, the lab worker using the fume hood relies heavily on the monitor and alarm to confirm safe operating status or to alert of unsafe air flows. Thus it is crucial that the monitor be calibrated accurately, and that the audible and visual alarms function as intended.

6.9.5.1 Calibrate the Monitor

For CAV bypass hoods, use three different sash positions (at design position, and at 150 mm above and below design position).

For VAV hoods, maintain the sash at design position while using the BAS to adjust flow as follows: 10% below target face velocity, 10% above target face velocity, and at target face velocity.

Calibration of monitors for both CAV and VAV hoods will require face velocity measurements using the grid procedures described in [Section 6.9.2.1: Face Velocity](#).

6.9.5.2 Check Alarms

Green light indicates safe operation, and red light indicates unsafe condition. Check the alarms as follows:

1. Commence with the monitor indicating desired face velocity, typically a nominal value of 0.50 m/s (or 0.35 m/s for an HP fume hood).
2. Manually increase/decrease flow such that the face velocity increases/decreases beyond +/- 10% of the set point. Verify that the indicator light switches from green to red and that audible alarm enunciates within 10 seconds.
3. Confirm that the monitor has sent the alarm condition to the BAS.

6.9.6 Experiment Apparatus Test Procedures

6.9.6.1 As Manufactured Simulated Apparatus

Tests at the manufacturer must include performance tests with the hood empty **AND** with the hood loaded to simulate experimental apparatus in the hood. The simulated apparatus should consist of two 3.8-litre round paint cans, one 300 mm × 300 mm × 450 mm cardboard box, and four 150 mm × 150 mm × 300 mm cardboard boxes. These items should be located approximately 150-250 mm behind the plane of the sash according to the general arrangement depicted in the figure below. This arrangement is only illustrative and the dimensions shown in [Figure 6-5](#) should be adjusted according to the fume hood size.

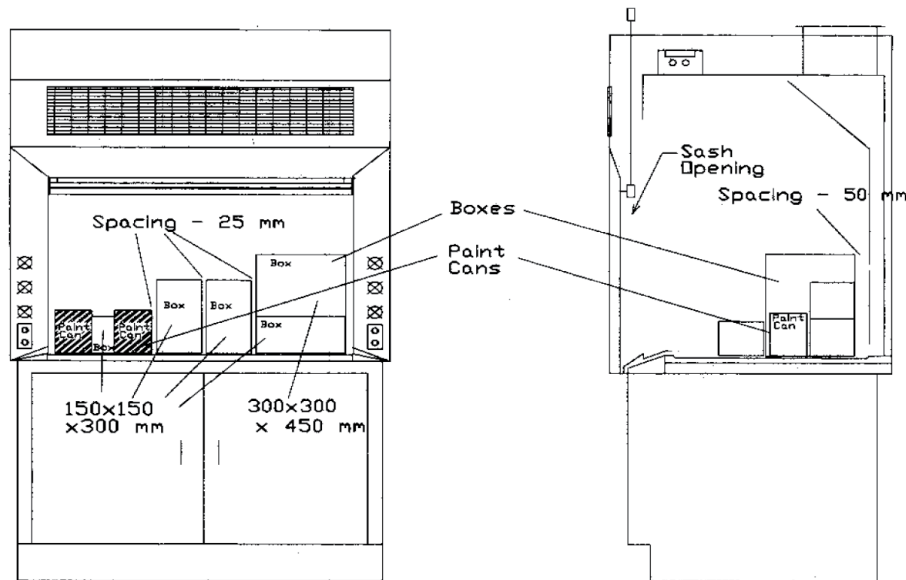

Figure 6-5: Simulated Apparatus Test Setup

6.9.6.2 As Used Apparatus in Place

On-site testing of a fume hood is normally done with the hood empty. However the laboratory setting often requires that apparatus be placed in the hood to enable procedures there. If the apparatus is of significant size or shape, it is recommended that performance testing be carried out in the *as used* condition, with such equipment in place and operating as it normally would. The scope of the performance testing is to be at the discretion of the laboratory director and/or the project authority.

6.9.6.3 Static Pressure Test Procedure

This test is intended to confirm that the pressure drop across the fume hood is moderate and thus does not contribute to excessive noise levels or undue static pressure requirements through the exhaust system.

1. Place sash in design position, and ensure face velocity is approximately 0.5 m/s (0.35 m/s for HP hood).
2. Using a magnehelic or other pressure device, insert the tube from the low-pressure tap into the exhaust duct approximately 300 mm above the fume hood exhaust collar.
3. The high-pressure tap shall sense static pressure within the lab space.
4. Record pressure drop in Pascals (Pa).

6.9.7 Noise Test Procedure

1. Place sash in design position and ensure face velocity is approximately 0.5 m/s (0.35 m/s for HP hood).
2. Place noise meter in front of the fume hood at the working position, 300 mm out from the plane of the sash and 1.2 m above floor level.

Record noise level in dBA, and determine the average reading over a 30-second time frame.

APPENDIX A

SMOKE VISUALIZATION TEST PROTOCOL

A.1 Purpose

The purpose of this protocol is to describe the methods and apparatus needed to produce a consistent smoke challenge from a diffuser in the testing of fume hoods. The protocol is designed to meet PWGSC testing requirements for visualizing air flow and challenging fume hood containment in a consistent manner and for providing the ability to access results consistently.

A.2 Smoke Visualization Tests Apparatus

The devices and apparatus described below were designed to facilitate implementation of this guideline and the *ANSI/ASHRAE 110* standard's smoke visualization test, and to provide a consistent test protocol.

This is only one of the designs that have been demonstrated to meet PWGSC smoke visualization testing criteria. PWGSC is open to alternative designs that can be demonstrated to meet testing criteria. The primary criteria for the smoke generator and diffuser equipment are as follows:

1. The smoke being generated must be controlled and metered.
2. The smoke visualization tests are repeatable, i.e., results of repeated tests are consistent under similar conditions.

Performance of the smoke visualization test requires a smoke generator, smoke diffuser, smoke and air transfer fan, fluid flow meter, fluid flow adjustment valves, power supply, and an interconnecting smoke transfer hose. Each of these components is described below:

A.3 Smoke Generator

The commercially available theatrical smoke generator (such as the Rosco Delta 3000 or equivalent) produces glycol- and water-based smoke. The system-supplied analog controller controls the pumping rate of the smoke fluid but does not provide the finite control necessary to adjust the smoke generation volume to the desired level.

Modifications should be made by teeing into the discharge line of the fluid pump, adding a return line to the fluid supply reservoir, and incorporating a metering valve in order for the smoke fluid flow rate to the heated smoke generation chamber of the smoke generator to be controlled precisely.

A rotameter fluid flow meter allows the testing technician to confirm that the correct fluid consumption rate is maintained and the correct volume of smoke is being generated.



Figure A-1: Smoke Generator



Figure A-2: Analog Controller



Figure A-4: Smoke Diffuser

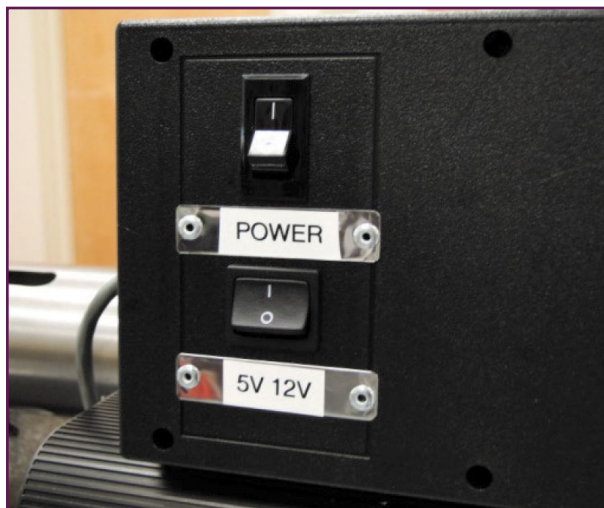

Figure A-3: Power Supply

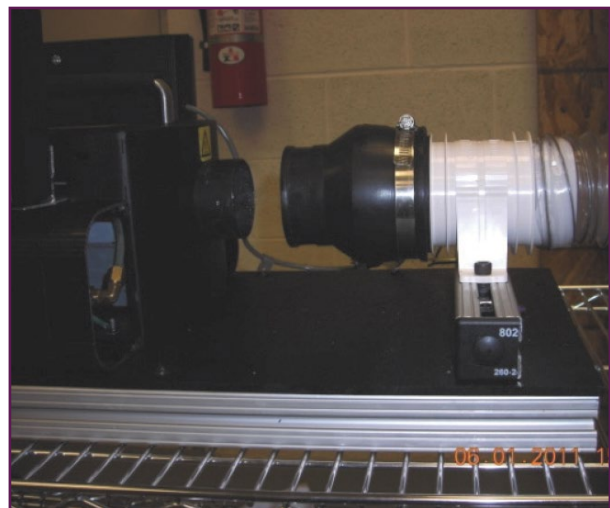

Figure A-5: Smoke and Air Transfer Fan

The smoke fluid consumption rates should be controllable between 3 ml/min and 10 ml/min (high-volume challenge). The analog controller should be considered as the base control for the generator. (See [A.8: Fluid Flow Adjustment Valves](#) for the final flow adjustment description.) Refer to [A.15](#) and [A.16](#).

A.4 Power Supply

The power supply provides the required DC voltage for the smoke and air transfer fan (5V DC or 12V DC).

A.5 Smoke Diffuser

The smoke diffuser, a self-supporting device that can be placed in the hood, diffuses the total volume of generated smoke evenly across its diffusion surface. Generated smoke, aspirated air, and transport air should be delivered to the smoke diffuser through a hose with a 5 cm internal diameter. The velocity of the transport air should be 2.2 m/s during smoke generation and 1.9 m/s without smoke generation while maintaining the diffusion exit velocities < 0.125 m/s.

The diffusion surface should be engineered to maintain prescribed exit velocities while constantly delivering aspirated air, transfer air, and the generated smoke at a combined rate of 3.9 to 4.4 l/s. The vertical height of the diffuser should have a length longer than the design operating sash height, with a minimum height of 75 cm. The outside diameter of the smoke diffuser should be around 12 cm. Refer to [A.15](#), [A.16](#), and [A.17](#).

A.6 Smoke and Air Transfer Fan

The smoke and air transfer fan should be an in-line axial fan driven by a direct current (5V DC or 12V DC) motor. The fan provides the motive force required to move the generated smoke, aspirated air, and transfer air through the smoke transfer hose to the smoke diffuser. In addition, the fan provides the energy to overcome the static pressure losses of the smoke transfer hose and the smoke diffuser and prevents smoke from being released into the laboratory outside of the fume hood. The fitting passes the required transfer and aspirated air into the fan inlet, thereby allowing the generated smoke to be transferred to the smoke diffuser.

A.7 Fluid Flow Meter

The fluid flow meter is an analog rotameter that has a display range capable of displaying a flow rate between 0 and 65 flow units. The meter should be placed in line between the fluid pump outlet and the inlet of the heated smoke generation chamber of the smoke generator.

A.8 Fluid Flow Adjustment Valves

Fluid flow and consumption rate are achieved by adjusting two fluid flow adjustment valves and monitoring the flow rate on the fluid flow meter. Coarse adjustments are made by regulating the pumped fluid bypass back to the fluid reservoir and by fine adjustments of the fluid flow rate to the heated smoke generator.

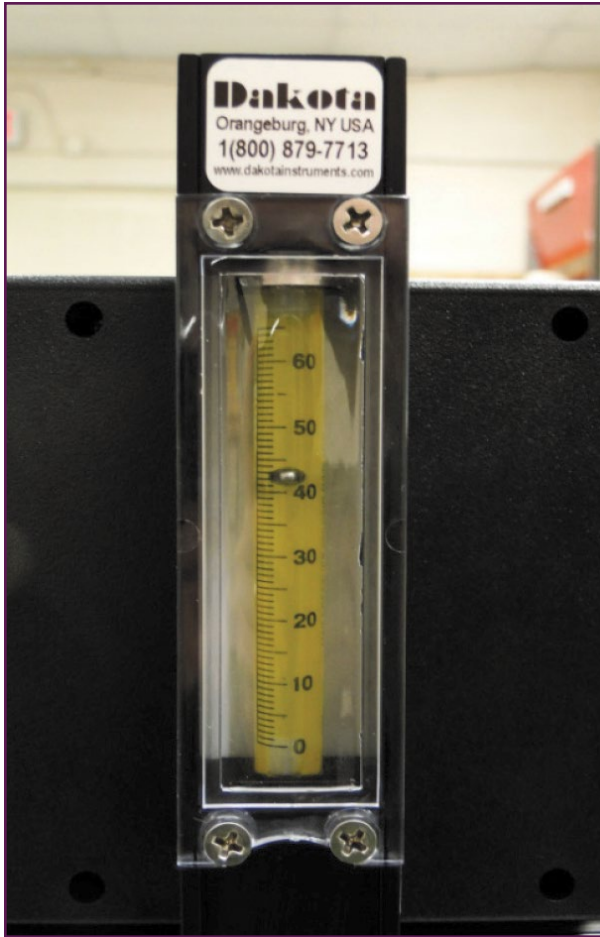

Figure A-6: Flow Meter

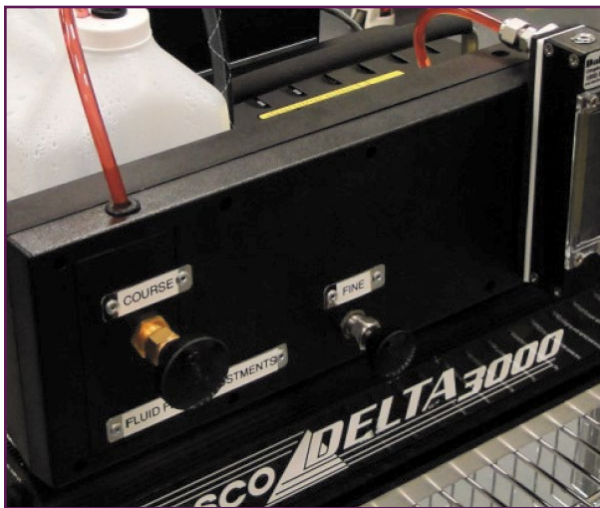

Figure A-7: Flow Adjustment Valve

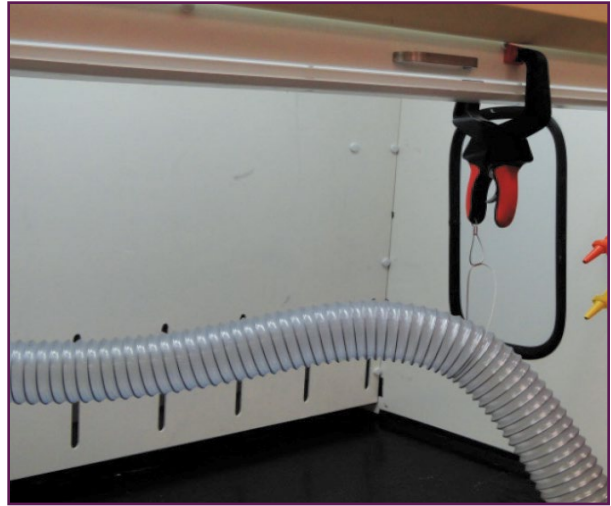

Figure A-8: Smoke Transfer Hose



Figure A-9: Smoke Transfer Hose Connection Clamp

A.9 Smoke Transfer Hose

The smoke transfer hose connects to the outlet of the smoke and air transfer fan and the inlet of the smoke diffuser. Also pictured is a transfer hose stabilization clamp (clipped to the sash) used to ensure the hose does not cause tipping of the smoke diffuser.

A.10 Smoke Visualization Test Protocol

This test protocol describes the set-up and procedure for conducting a smoke visualization test that employs the discharge of a large-volume smoke from a diffuser located inside the fume hood.

Discharge of smoke from the diffuser will satisfy both low-volume and high-volume smoke visualization tests. Smoke generated from the smoke generator and discharged from the smoke diffuser is controlled to ensure a consistent delivery of low-velocity smoke to allow for observation of air flow patterns inside the hood and near the plane of the sash.

The intent of this test is to assess the performance of the hood as it is typically used. Because the investigator is often standing at the face of the hood while performing the tests, the test method involves placing a mannequin at the opening to simulate a hood user and observing unobstructed smoke patterns in the hood and air flow patterns downstream of the mannequin. The method describes the care necessary to ensure that the body of the investigator does not influence the smoke visualization challenges.

Under ideal conditions, smoke will be drawn from the point of release (diffuser) and flow smoothly toward the slots in the rear baffle.

Similar to tracer gas tests described in this guideline and *ANSI/ASHRAE 110* tests, the diffuser is located at a minimum of three locations across the opening. Bench-top hoods with sizes larger than 1.83 m require five or more test locations depending on the width of the hood. The protocol describes methods applicable to bench-top fume hoods, distillation fume hoods, and walk-in fume hoods having vertical sashes or horizontal sashes.

A plume of smoke or aerosol is generated within the hood to visualize air flow patterns and detect escape beyond the plane of the sash. A modified commercial smoke generator is used to generate a low-velocity plume from a cylindrical diffuser located 20 cm from the centreline of the diffuser to the plane of the sash and at a minimum of three locations within the hood (left, centre, and right).

The following sections describe the protocol for locating the diffuser inside the fume hood, generating the smoke, and observing the smoke patterns. The method for describing and rating air flow patterns and hood containment is provided in [A.14: Describing and Rating Air Flow Patterns](#).

A.11 Smoke Diffuser Locations

The location of the diffuser within the hood depends on the size and design of the fume hood. There are many different types of laboratory fume hoods and opening configurations afforded by different sash designs. The following describes the diffuser locations required for different hood types. *The owner should be consulted for the appropriate locations for fume hood designs and sash opening configurations that are not represented herein.*

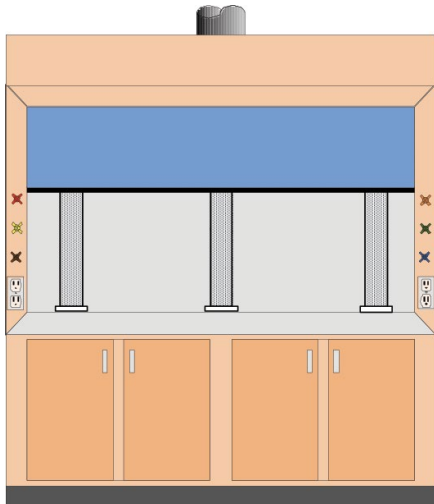

Hoods with Width 1.8 m or Less

Figure A-10: Smoke Diffuser Positions for Hoods with Width 1.8 m or Less

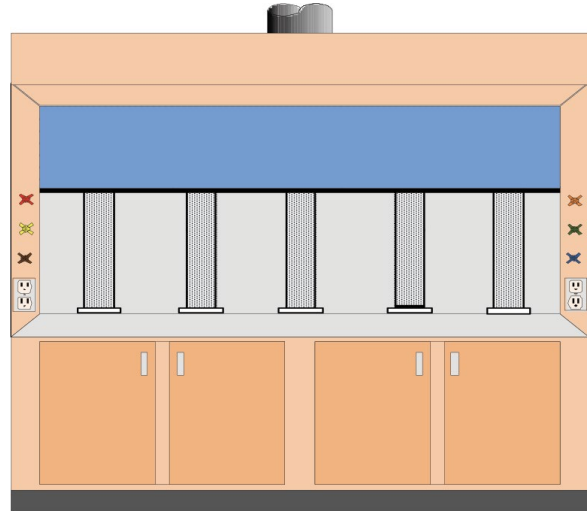

Hoods with Width of 2.4 m

Figure A-11: Smoke Diffuser Positions for Hoods with Width of 2.4 m

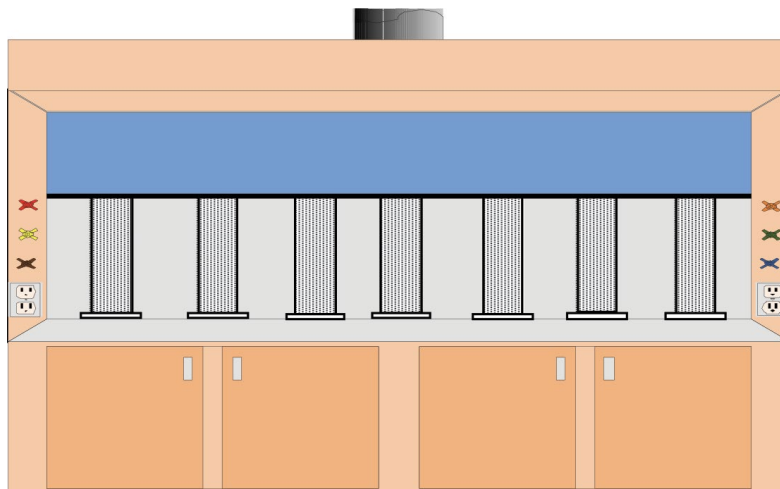

Hoods with Widths Greater Than 2.4 m

Figure A-12: Smoke Diffuser Positions for Hoods with Widths Greater than 2.4 m

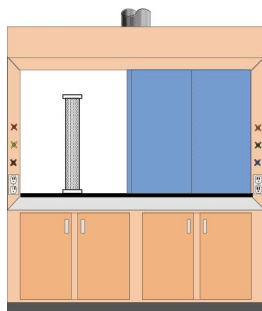

Left Position

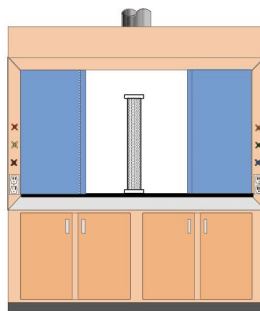

Centre Position

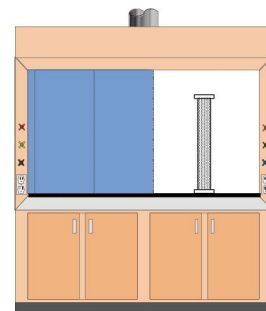

Right Position

Figure A-13: Horizontal Sash Positions

A.11.1 Bench-Top Vertical Sash Fume Hood

For bench-top fume hoods equipped with single vertical sashes and sizes up to 1.8 m, the diffuser is located in a minimum of three positions inside the hood: 20 cm inside the plane of the sash located left, centre, and right of the opening, measured to the centre line of the diffuser. The left and right locations are 20 cm from the side wall measured to the centre point of the diffuser.

Since the diffuser is approximately 11.5 cm in diameter, locating the centreline of the diffuser 20 cm from the plane of the sash and the side walls results in the side of the diffuser only 15 cm from the boundaries.

[Figure A-10](#) depicts the three smoke diffuser positions for hoods with a nominal width of 1.8 m or less.

Additional test positions are required for hood sizes larger than 1.8 m. The number of additional positions is determined by the distance between the side and centre positions where the maximum distance between positions cannot exceed 61 cm.

Where the distance between the centre and side diffuser locations is greater than 61 cm, additional positions for the diffuser will be located at a position equidistant between the centre and side positions.

Figures [A-11](#) and [A-12](#) depict smoke diffuser positions for hoods with widths greater than or equal to 2.4 m and [Table A-1](#) quantifies the number of smoke diffuser positions.

Table A-1: Number of Smoke Diffuser Locations by Hood Width

Number of Test Positions	Nominal Hood Width (m)						
	0.9	1.2	1.5	1.8	2.4	3.1	3.7
3	X	X	X	X			
5					X		
7						X	X

A.11.2 Bench-Top Horizontal Sash Fume Hood

Air flow visualization tests are conducted by placing the smoke diffuser at the centre of the maximum horizontal openings. The air flow patterns are observed at a minimum of three openings corresponding to the maximum left, centre, and right opening configurations, as shown in [Figure A-13](#).

Fume hoods having combination vertical and horizontal sash openings shall be tested according to both the vertical and horizontal sash configurations.

A.11.3 Distillation Fume Hoods and Floor-Mounted Fume Hoods

Similar to bench hoods, floor-mounted fume hoods shall be tested for all sash configurations. The smoke diffuser shall be placed or supported inside the hood a distance of 20 cm back from the plane of the sash.

[Figure A-14](#) depicts an end view of these hoods, with vertical sashes in alternate configurations.

For floor-mounted fume hoods equipped with horizontal sashes, the smoke diffuser shall be placed or supported in the centre of the alternate horizontal sash configurations. See [Figure A-15](#).

Note: In all cases the sashes shall be placed at the maximum design opening.

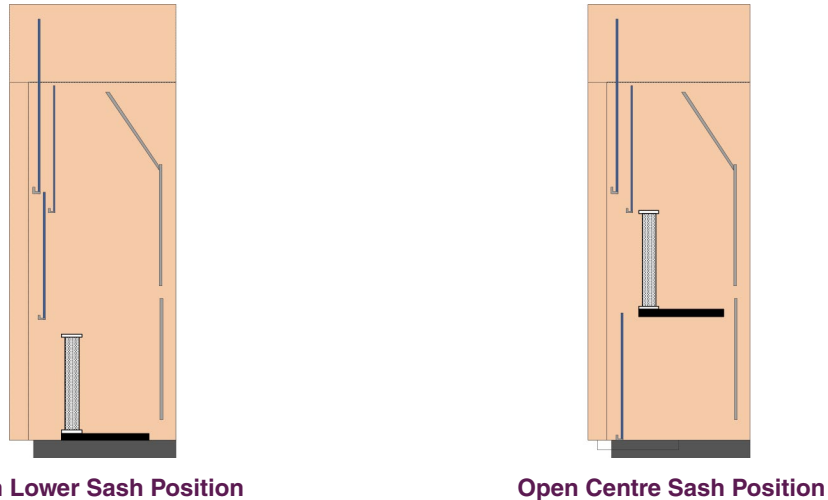

Figure A-14: Floor-Mounted Hoods—Vertical Sash Configurations

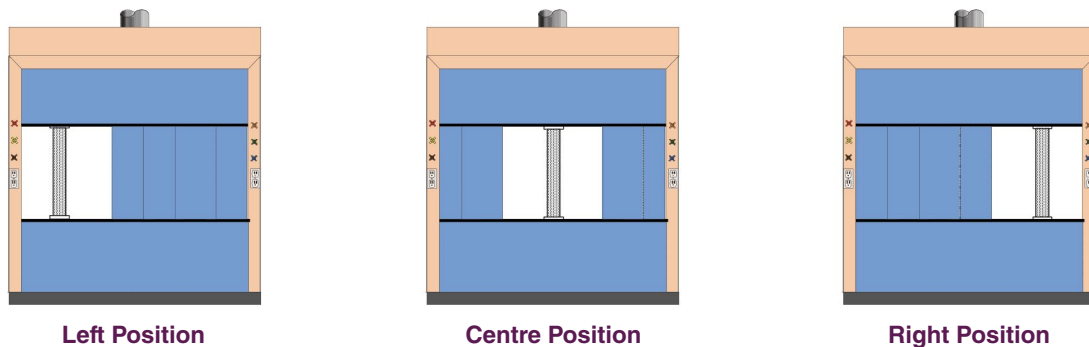

Figure A-15: Floor-Mounted Hoods—Horizontal Sash Configurations

A.12 Smoke Generator Discharge Volume Adjustment Procedure

To provide a consistent and replicable volume of visible smoke for performing the visualization tests, the smoke generator must be checked and/or adjusted prior to each test. The volume of smoke production is controlled by the rate of smoke fluid consumption. The following procedure describes the method for adjusting the smoke fluid consumption rate:

1. Apply power to the smoke generator and allow the heated smoke generation component to warm.
2. Locate the smoke diffuser inside the hood.
3. Connect the transfer hose to the smoke diffuser and the smoke generator.
4. Set the smoke transfer fan speed to the operational volume setting of 5 volts.

5. After the ready light appears on the analog controller, switch the smoke generation toggle switch to the "ON" position.
6. Adjust the analog controller smoke volume control to a setting of 5 on the dial.
7. Completion of the following steps will result in a fluid flow rate of 9 to 11 ml/min into the smoke generator. See system schematic in [A.16.4](#).
 - a. Close the coarse control valve completely.
 - b. Open the fine control valve completely.
 - c. Open the coarse control valve to achieve 65 flow units on the fluid flow rotameter.
 - d. Close the fine control valve to achieve an indication of 40 to 50 flow units on the fluid flow rotameter.
8. Ensure smoke is issuing evenly from the smoke diffuser and there are no leaks in the tubing that could be falsely identified as or improperly attributed to escape from the hood.
9. Cease smoke generation by switching the smoke generation toggle switch on the analog controller to the "OFF" position. Purging the hose and diffuser of remaining smoke can be accomplished by setting the smoke transfer fan speed to 12 volts.

Note: The transfer hose between the smoke generator and smoke diffuser will accumulate condensed fluid. It is necessary to periodically disconnect the transfer hose and drain the accumulated condensation. The transfer hose should be drained after 10 minutes of continuous use or between fume hood smoke visualization tests.

A.13 Smoke Visualization Test Procedures

Prior to initiating the smoke visualization tests:

1. Determine the configuration of all sash positions to be tested.
2. Determine all placement locations for the smoke diffuser inside the hood to ensure the diffuser can be properly placed and supported.
3. Identify and make a record of any equipment and/or apparatus inside the hood that may impair the hood's air flow patterns.
4. Identify and make a record of any laboratory conditions that may impair the fume hood's air flow patterns.
5. Follow and complete the smoke generator's volume adjustment procedure.

After completion of the above tests, the smoke visualization tests can be performed by following the smoke visualization test procedure below:

1. Open the hood sash to the full open position.
2. Place the diffuser at the prescribed location in the fume hood.
3. Position the sash to the prescribed opening configuration.
4. Set the smoke transfer fan speed to the operational volume setting (5 volts).
5. Begin smoke generation at the prescribed set point and observe air flow patterns for 30 seconds while standing to the side of the opening, not closer than 30 cm to the plane of the sash.
6. Record observations.
7. Place a test mannequin with its imaginary breathing zone 8 cm outside the plane of the sash and directly in front of the smoke diffuser (see [Figure A-16](#)). Observe air flow patterns for 30 seconds.

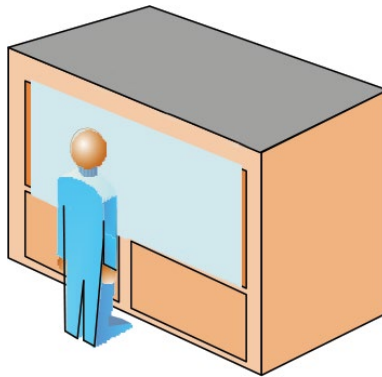

Figure A-16: Mannequin Placement

8. Record observations.
9. Cease smoke generation, continue to observe smoke patterns within the hood, and measure the length of time to evacuate the visible residual smoke from the hood interior.
10. Record the time to evacuate the smoke from the hood interior.
11. Evaluate the observations made during the smoke visualization test and assign the pass/fail rating as described in [A.14: Describing and Rating Air Flow Patterns](#) below.
12. Record evaluation and rating results.
13. Following cessation of smoke generation and final observations, move the diffuser to the next test location and repeat steps 2-12.
14. After completing tests at all of the required smoke diffuser locations, turn the power off on the analog controller of the smoke generator and set the smoke transfer fan speed to the purge volume setting (12 volts). Allow the fan to operate for 2 minutes at the purge volume before turning the smoke transfer fan off. (This step will purge smoke from the generator, transfer hose, and diffuser).

A.14 Describing and Rating Air Flow Patterns

The following provides the procedure of describing and rating air flow patterns:

1. Airflow patterns shall be observed and noted.
2. All of the smoke generated within the hood should be carried to the back of the hood and exhausted.
3. The following describes typical air flow problems as demonstrated by smoke visualization.
 - a. If the smoke moves forward toward the front of the hood, the air flow is described as “reverse flow.”
 - b. If the smoke remains on the work surface without smoothly flowing to the back baffle, the air flow is described as “lazy.”
 - c. If the smoke moves outside the plane of the sash, this observation is described as “escape.”

Reverse flow does not apply to the forward motion of the roll inside the hood that occurs in the upper cavity of the hood, above the vertical sash opening, or to the cyclonic motion behind a closed horizontal sash. (Reverse flow in areas at the top of the hood or behind the sash panels is called a vortex roll.)

A.15 Recommended Performance Criteria

All tests shall meet the criteria established in [Table A-2: Air Flow Visualization Performance Criteria](#) below.

Fume hoods must provide complete containment of the smoke generated within the hood. Smoke is generated using a consistent and replicable method, but containment is determined visually and rated subjectively. Results are reported as a qualitative judgment of air flow distribution and containment according to the following guide:

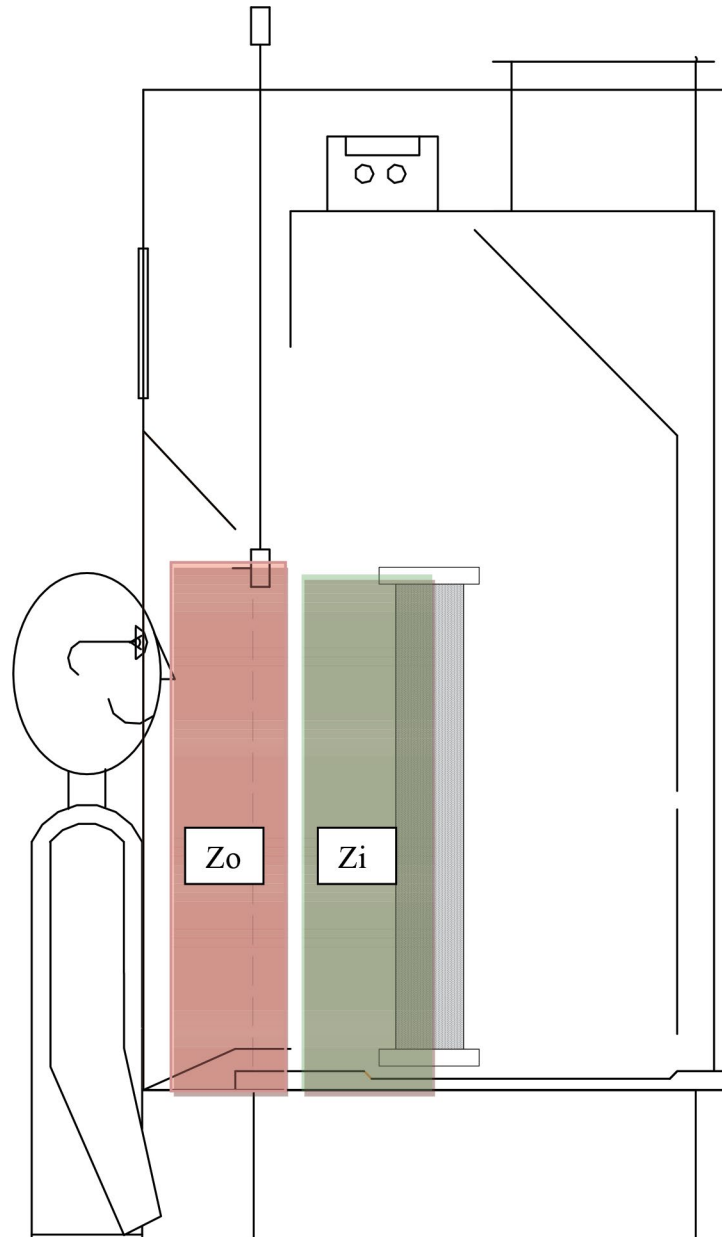

Figure A-17: Smoke Observation

The assessment of smoke containment involves observation of air flow patterns in two primary zones labelled Z_i and Z_o , where:

1. Z_i refers to the area 6 inches inside the plane of the sash.
2. Z_o refers to the area outside the plane of sash.

The assessment applies to tests with and without the mannequin located at the test location.

Observation of no smoke in zone Z_i or zone Z_o indicates a rating of **High Pass**.

Observation of reverse flow (continuous or intermittent) within zone Z_i indicates acceptable containment but poor air flow patterns (**Low Pass**).

Observation of intermittent escape of smoke into zone Z_o indicates a **Low Fail**, whereas observation of continuous escape into Z_o or outside Z_o (into the room) indicates the worst case of escape or a **High Fail**.

Thus, the rating of containment and air flow patterns has two levels of pass ratings and two levels of fail ratings, as listed in the following table.

Table A-2: Airflow Visualization Performance Criteria

Rating		Initial Observation	Final Observation
Pass	High	Smoke discharged from the diffuser is not observed in the inner zone Z_i (within 6 inches of the inside of the sash plane) or in the outer Z_o zone (outside the sash plane).	The hood receives a High Pass rating.
	Low	Smoke discharged from the diffuser is observed in zone Z_i but not observed outside the plane of the sash.	The hood receives a Low Pass rating.
Fail	Low	Smoke discharged from the diffuser is observed as an intermittent escape outside the plane of the sash into zone Z_o . This occurrence automatically is assigned a Low Fail rating and requires two additional tests at this location to confirm the escape.	If the observation during the 2 nd or 3 rd test indicates repeated escape into zone Z_o , then the rating of Low Fail remains. If there is no indication of repeated escape, the test receives a Low Pass rating.
	High	Smoke discharged from the diffuser is observed continuously escaping outside the plane of the sash into zone Z_o , or intermittent escape is observed beyond zone Z_o and into the room.	The hood receives a High Fail rating.

A.16 Equipment Set-Up Diagrams

A.16.1 Smoke Generator and Diffuser Set-up

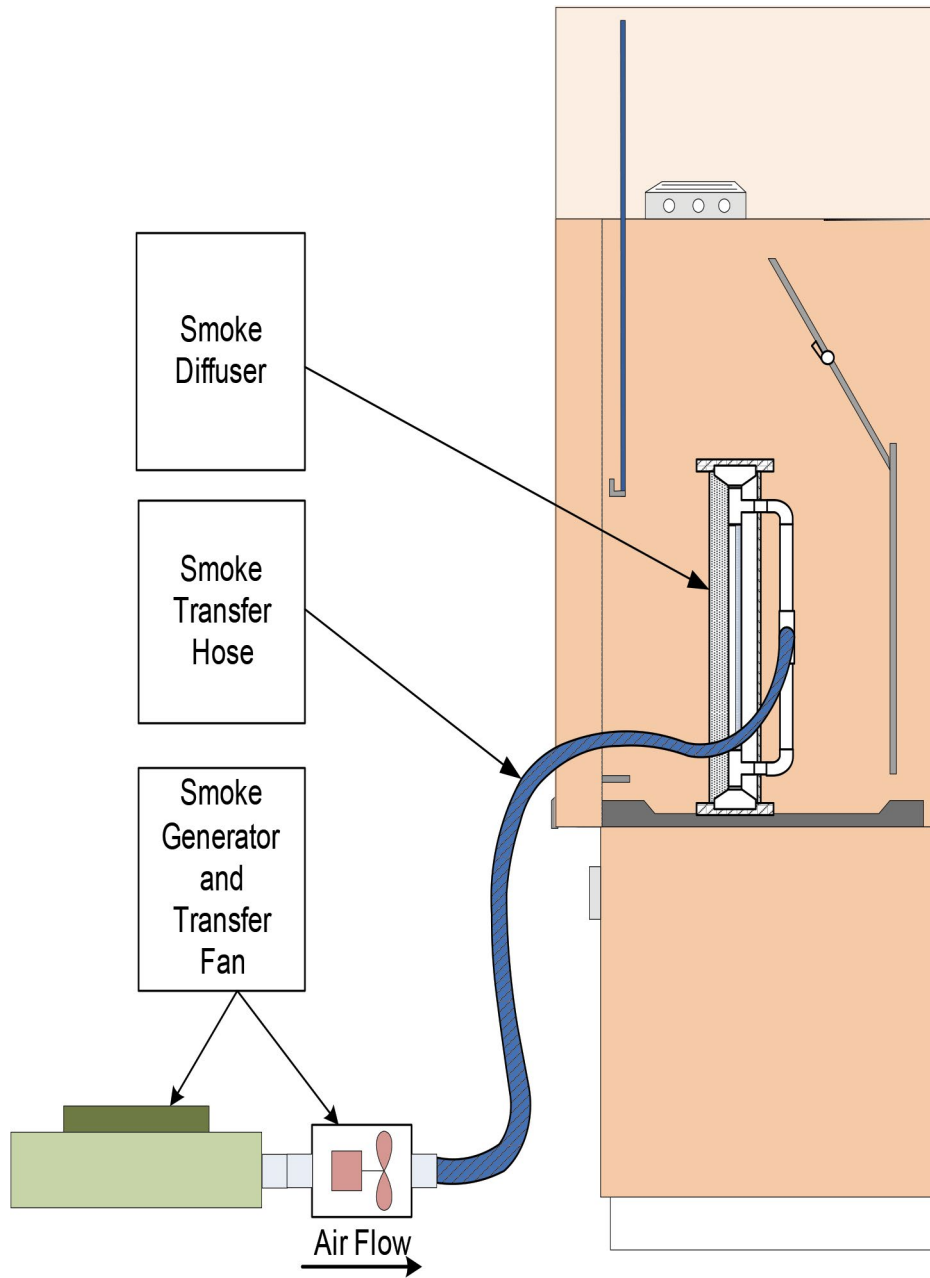

A.16 Equipment Set-Up Diagrams (cont'd)

A.16.2 Diagram of Smoke Diffusion Patterns

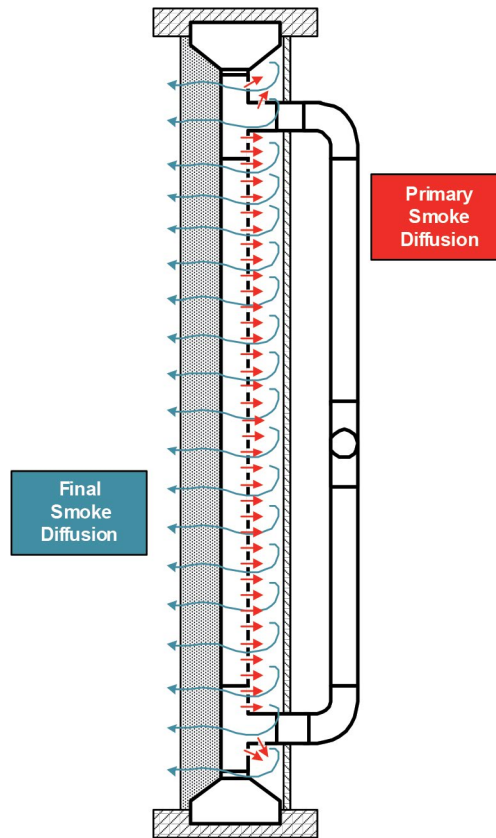

A.16 Equipment Set-Up Diagrams (cont'd)

A.16.3 Component Parts of the Smoke Diffuser

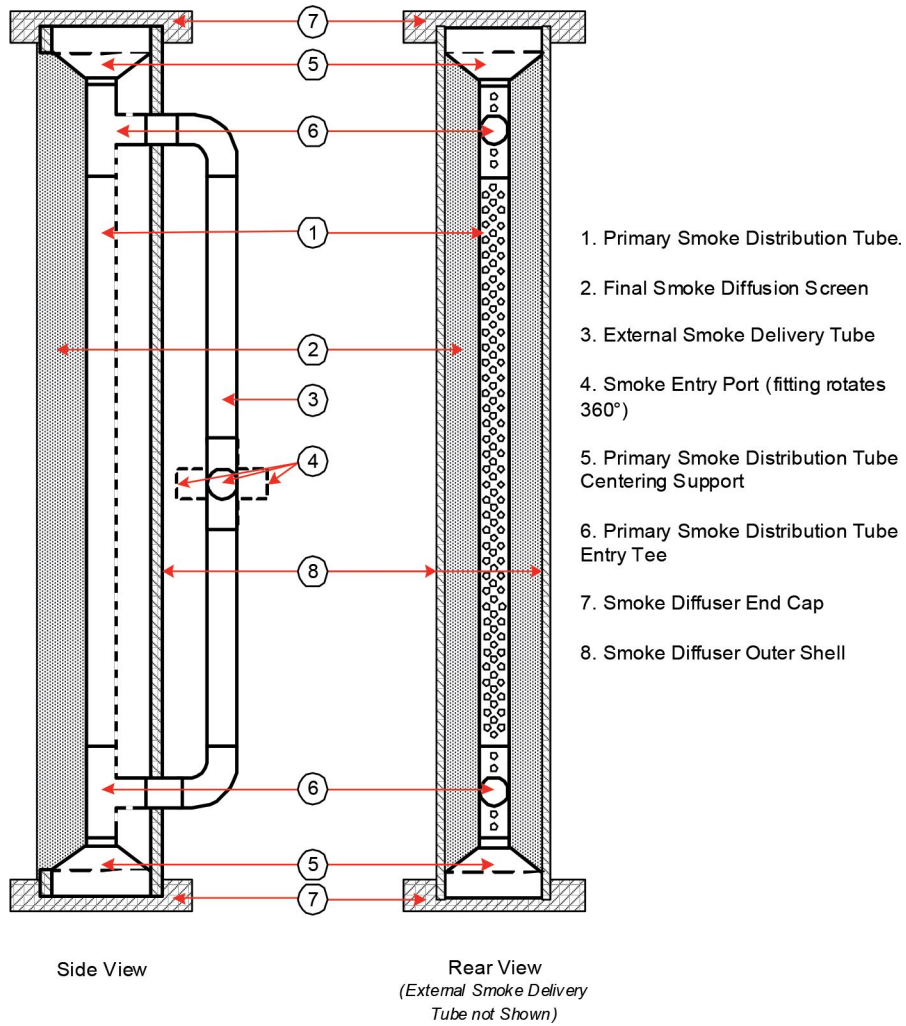

A.16 Equipment Set-Up Diagrams (cont'd)

A.16.4 Component Parts of the Smoke Generator

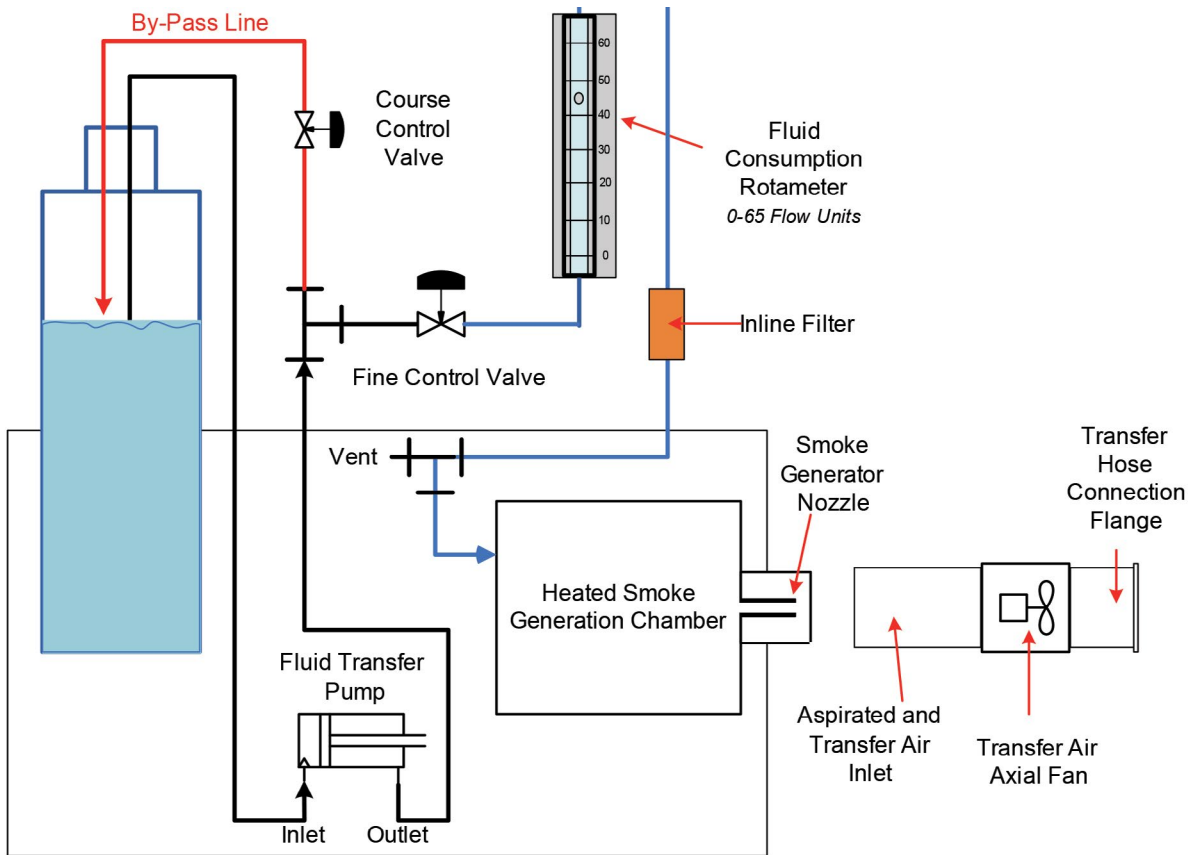

A.17 Fume Hood Smoke Generator/Diffuser Testing Apparatus

The contractor/testing agency should construct or purchase a smoke generator and smoke diffuser testing apparatus that meets the criteria as described in [A.2: Smoke Visualization Test Apparatus](#) or as shown in the drawings. The apparatus should be constructed so that it meets the testing design criteria and complies with all local and provincial sanitary and safety regulations.

Described herein are the specifications for air flow velocities, air flow volumes, smoke fluid consumption and pumping rates, smoke discharge volume, diffuser size, power ratings, as well as general design specifications for the following:

- | | | |
|-------------------------------|------------------------|---------------------------------|
| 1. Smoke Generator | 4. Smoke Transfer Hose | 7. Fluid Flow Meter |
| 2. Air Inlet Tee | 5. Smoke Diffuser | 8. Fluid Flow Adjustment Valves |
| 3. Smoke and Air Transfer Fan | 6. Power Supply | 9. Smoke Generation Fluid |

A.17.1 Smoke Generator and Smoke Fluid

Smoke Generation	Thermal—aerosol production
Heat Exchanger	Cast aluminum
Heater Electrical Rating	120V-14A/240V-7A
Main Fuse	120V-16A/240V-8A
Secondary Fuse	250V-25A
Smoke Fluid Reservoir	4.0-litre minimum
Smoke Fluid	Liquid, non-distillate propylene glycol, generation particle size of 0.25-60 micron
Smoke Generation Controller	Analog, controlling smoke generation volume, time interval between smoke generation cycles

A.17.2 Air Inlet Tee

Air Inlet	75 mm to 50 mm rubber pipe adapter
-----------	------------------------------------

A.17.3 Smoke and Air Transfer Fan

Fan	75 mm nominal diameter – axial design
Fan Motor	In-line, non-corrosive, nickel-plated
Fan Motor Power	5V DC or 12V DC, variable-speed

A.17.4 Smoke Transfer Hose

Hose	Low-friction, smooth interior, PVC with spiral wound support
Size	76 mm inside diameter
Length	Maximum 3 m

A.17.5 Smoke Diffuser

Overall Dimensions	See Design Drawings in A.17
Height	794 mm
Diffuser Diameter	114 mm
Stabilization Base	178 mm × 178 mm × 3.2 mm

A.17.6 Power Supply

Smoke Transfer Fan	5V DC or 12VDC, selectable
--------------------	----------------------------

A.17.7 Fluid Flow Meter

Meter	65 mm rotameter to measure 0 to 25 ml/min.; glass scale to have 65 graduations
Standard Accuracy	±2% of full scale
Calibrated Accuracy	±1% of full scale
Pressure Rating	1380 kPa
Repeatability	±0.25%
Operating Temperature Range	0 to 250°C

A.17.8 Fluid Flow Adjustment Valves

Needle Valve	Stainless steel, 6.35 mm tube connections, 0.31 flow coefficient, 13.8 mPa pressure rating
--------------	--

A.17.9 Velocities and Flow Rates

Transfer Air and Smoke Generation Volume	4.4 l/s
Transfer Air Velocity during smoke generation	2.2 m/s
Transfer Air (without smoke generation)	3.9 l/s
Transfer Air Velocity (without smoke generation)	1.9 m/s
Smoke Fluid Consumption Rate	Adjustable 3 to 10 ml/min.
Final Smoke Diffusion Velocity	≤ 0.127 m/s

A.18 Design Drawings—Smoke Diffuser

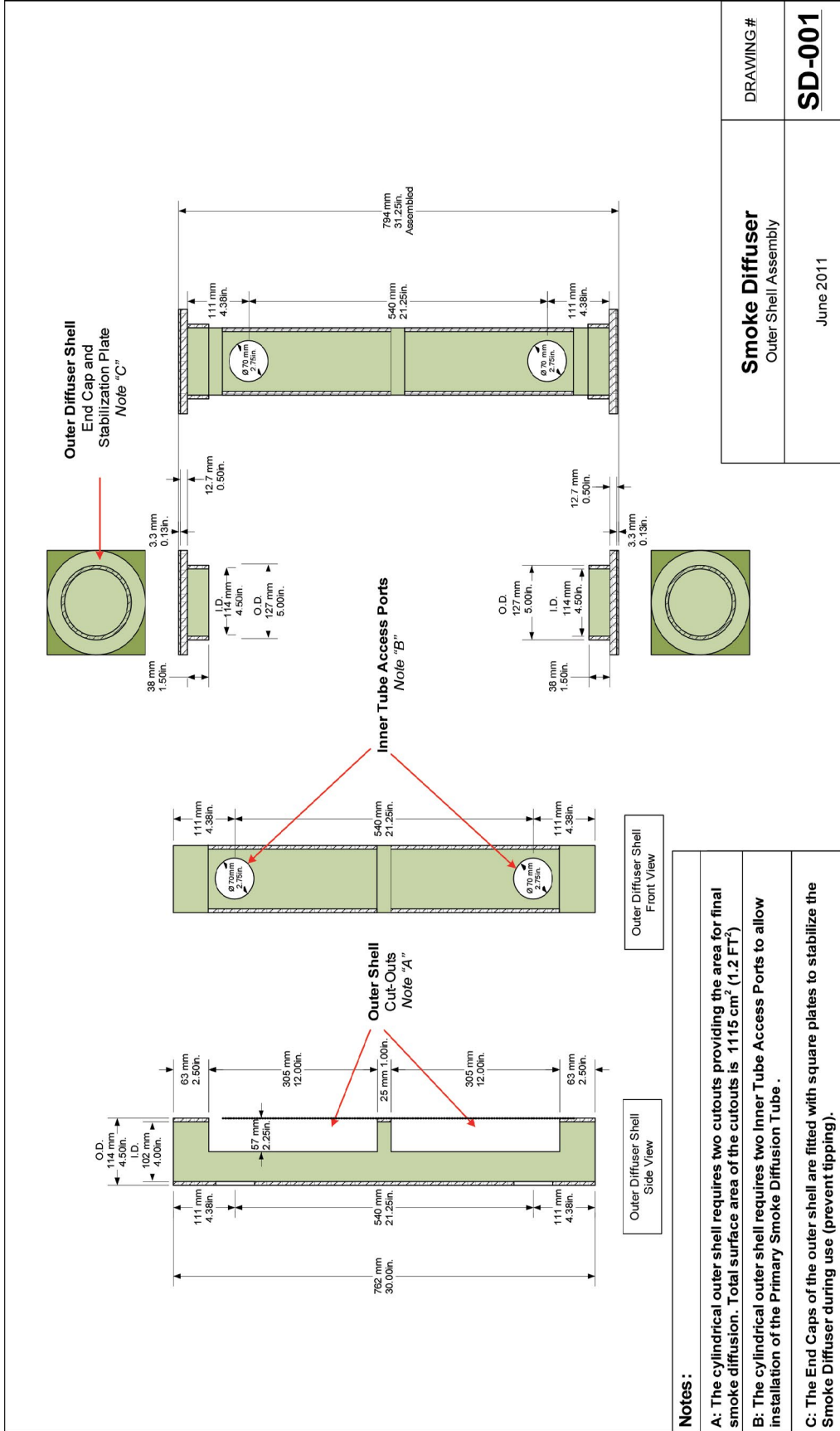

A.18 Design Drawings—Smoke Diffuser (cont'd)

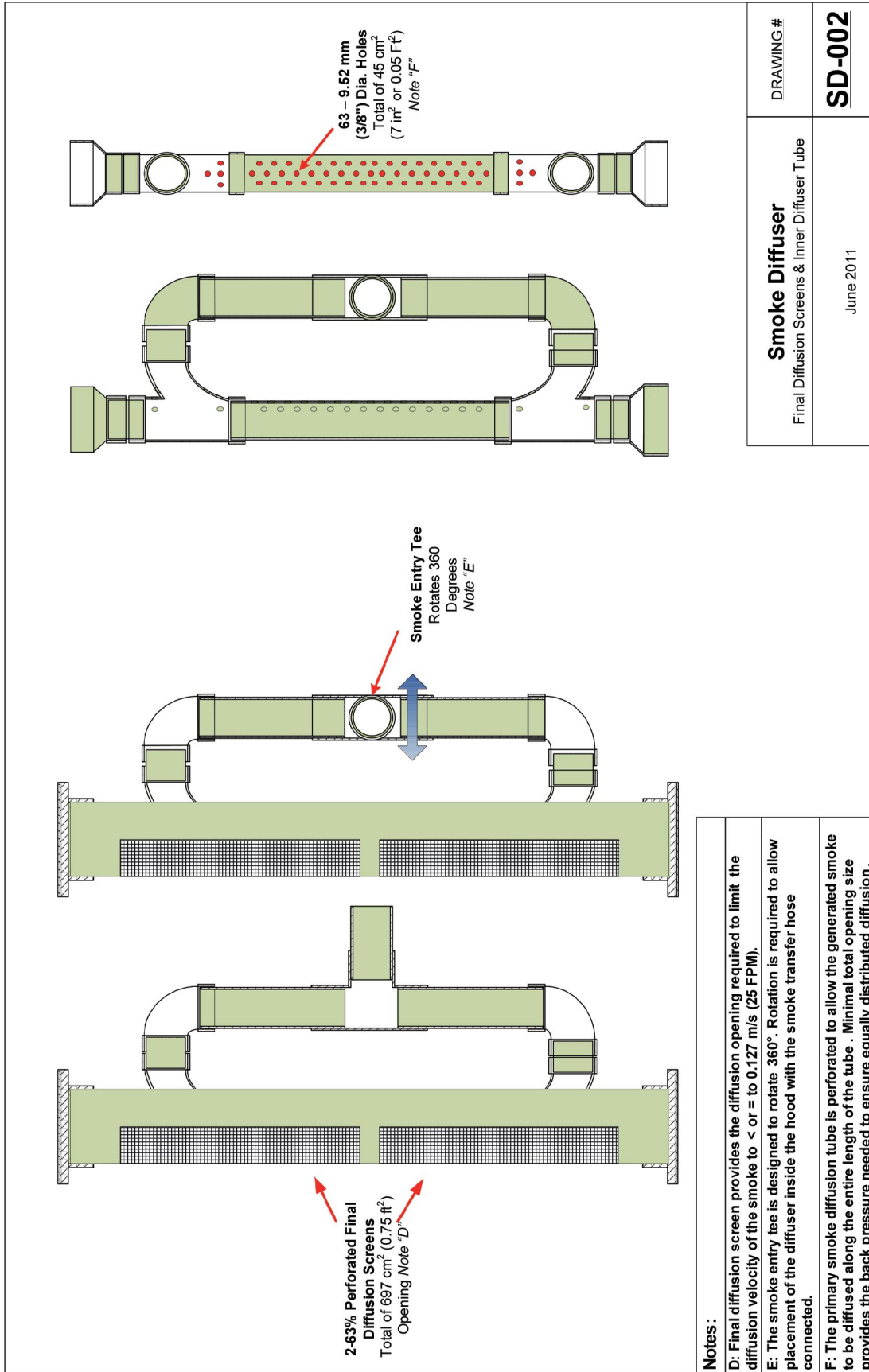

A.18 Design Drawings—Smoke Diffuser (cont'd)

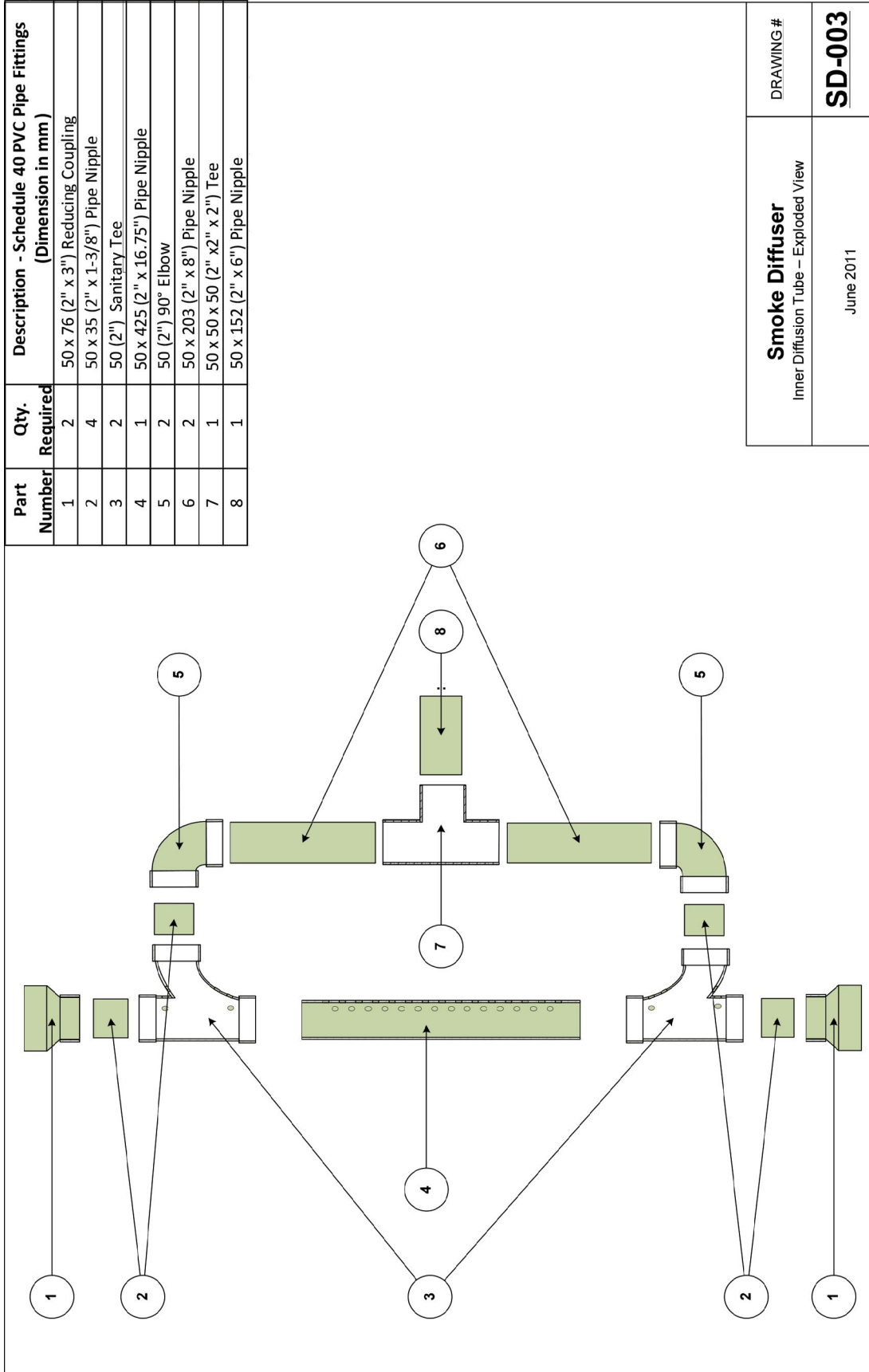

Part Number	Qty. Required	Description - Schedule 40 PVC Pipe Fittings (Dimension in mm)
1	2	50 x 76 (2" x 3") Reducing Coupling
2	4	50 x 35 (2" x 1-3/8") Pipe Nipple
3	2	50 (2") Sanitary Tee
4	1	50 x 425 (2" x 16.75") Pipe Nipple
5	2	50 (2") 90° Elbow
6	2	50 x 203 (2" x 8") Pipe Nipple
7	1	50 x 50 x 50 (2" x 2" x 2") Tee
8	1	50 x 152 (2" x 6") Pipe Nipple

Smoke Diffuser Inner Diffusion Tube – Exploded View	DRAWING # SD-003
June 2011	

A.18 Design Drawings—Smoke Diffuser (cont'd)

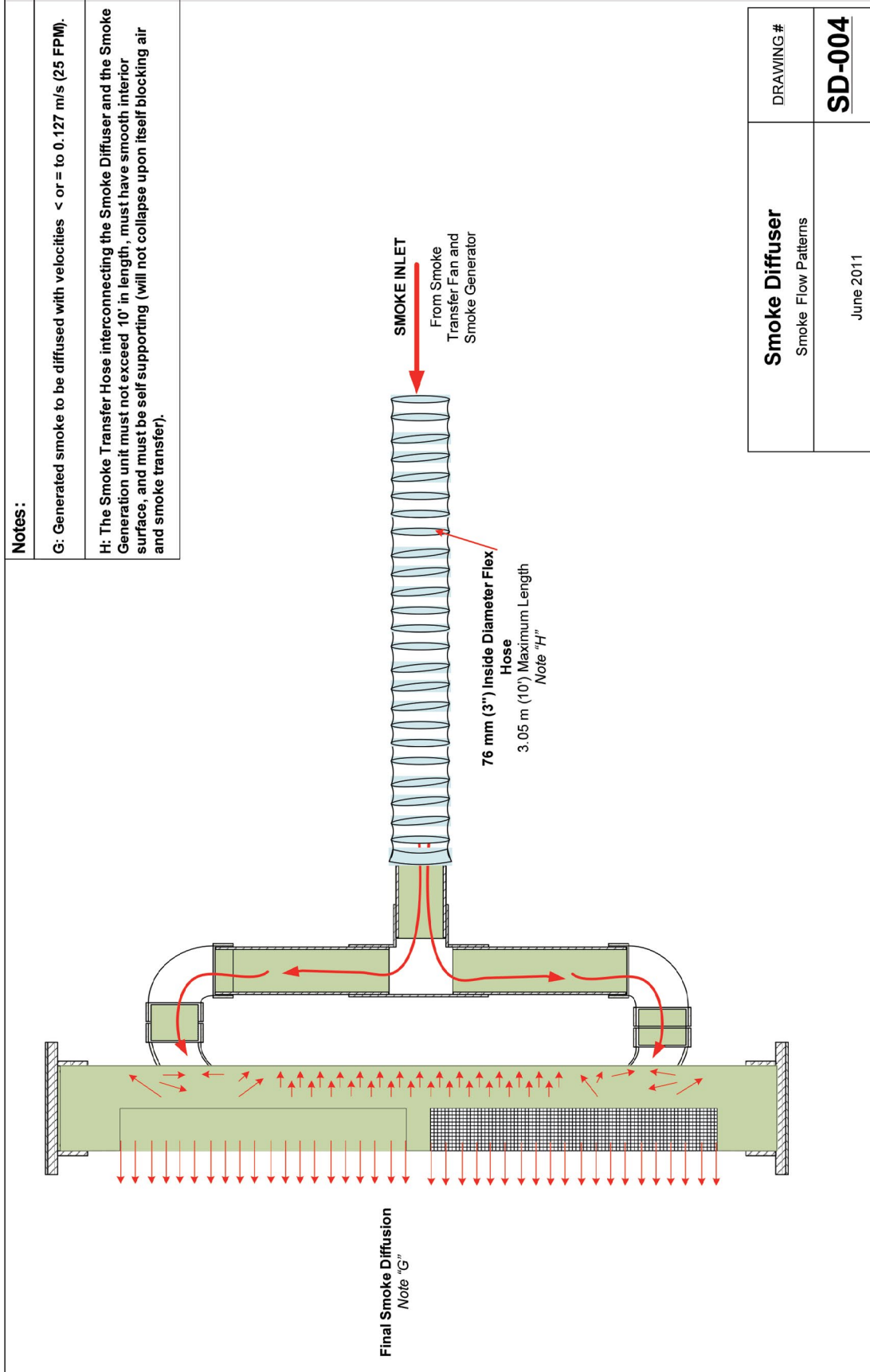

Smoke Diffuser Smoke Flow Patterns	DRAWING #
June 2011	SD-004

APPENDIX B

USE AND MAINTENANCE OF LABORATORY FUME HOODS

B.1 Proper Operation of Laboratory Fume Hoods— For Users

Proper operation of laboratory fume hoods is just as important as proper design and installation.

Before any laboratory personnel are allowed to operate a fume hood, they must receive training in its uses, limitations, and safety features. Given the right attitude and proper knowledge, planning, equipment, and technique, personnel in most laboratories will be able to handle any chemical safely.

These instructions may include written instructions, live demonstrations, and videotapes prepared by manufacturers, experienced researchers, technical institutes, etc.

Before any new fume hood is used, a notice listing its uses and limitations should be prominently displayed at the fume hood. The laboratory director should produce this notice.

Work involving the use of perchloric acid must always be carried out in fume hoods specifically designed and designated for perchloric acid. Refer to *MD 15129: Perchloric Acid Fume Hoods and Their Exhaust Systems*.

Although it is difficult to be specific in a manual of this nature, proper use of the fume hood should always include at least the following procedures:

1. Check fume hood monitor warning lights. Proceed only if green indicator light is illuminated.
2. Keep working surface uncluttered. This will assist in containment and also reduce disruption of air flow patterns. Where possible, equipment used within the hood should be elevated at least 25 mm above the work surface.
3. Do not block exhaust slots at the back of the hood.
4. Do not use the fume hood as a storage facility. Shelves should not be installed inside laboratory fume hoods.
5. Maintain sash at normal operating position or closed.
6. Position apparatus and materials toward the centre and at least 150 mm from the plane of the sash, to minimize disturbance of air flow into the fume hood through the sash opening.
7. Set up clean-up procedures to suit the processes used and the laboratory protocol.

B.2 Proper Maintenance of Fume Hoods— For O&M Personnel

B.2.1 Preventive Maintenance Programs

These are essential aspects of laboratory design and should be developed as the overall design of the facility is developed. Preventive maintenance programs should include, but not be limited to, the following:

1. Lubricating fan bearings and adjusting fan belts.
2. Checking sash operation and counterweight pulleys and cables for wear or deterioration.
3. Checking that sash limit stops are still in place and operate properly.
4. Checking the integrity of seals around lighting fixtures.
5. Inspecting all exhaust ducts for leaks and for unauthorized connections.
6. Checking that the fume hood is being used only for the purpose for which it was designed.
7. Checking all surfaces in contact with fumes for damage, abrasion, and rough surfaces.

B.2.2 Fully Detailed Operating and Maintenance Manuals

These are essential and should be **SPECIFIC TO THE PROJECT**. The Operating Manual and the Maintenance Manual form an integral part of the Building Management Manual.

B.2.3 Operating Instructions

These should be complete, concise, and clear, and they should be located in plain view of the fume hood user. This should also include all warning notices and alarms. See [B.3: Fume Hood Log Book, Table of Contents](#).

B.2.4 Performance Tests

The performance tests described in detail in [Chapter 6: Fume Hood Performance and Testing Requirements](#) should be carried out at the intervals shown in [Table 6-7: Fume Hood Test Frequency](#), also in Chapter 6.

B.2.5 HVAC Systems

Maintenance programs must include verification of HVAC and general exhaust systems, including confirmation of pressure relationships.

B.2.6 Laboratory Use

The laboratory director should organize regular reviews of programs within labs and the operation of equipment. The laboratory director should also set in place procedures for reporting and correcting defective equipment and for enabling improvements in operating and maintenance procedures.

B.3 Fume Hood Log Book

It is strongly recommended that a log book be kept for each fume hood and be permanently located at the fume hood, as a reference for users and O&M personnel. The following is a sample table of contents for such a logbook. It should be modified for each specific laboratory installation.

Fume Hood Log Book Table of Contents

PROGRAM USER SECTION

1. **Chemical Usage Log**
2. **System Definition**
 - a. Fume Hood Alarm
 - i. Function/Description—for User
 - ii. Operation—by User
 - b. Room Air System
 - i. Description—for User
 - ii. Operation—by User
 - c. Fume Hood
 - i. Operation—by User
 - ii. Maintenance—by User
3. **Test Report**
 - a. Face Velocity Report
 - b. Smoke Test Report
 - c. Visualization Test Report
 - d. Tracer Gas Test Report
 - e. Alarm/Monitor Test Report
 - f. Sensors Calibration Report
 - g. Other Reports
 - i. Hood Static Pressure
 - ii. Noise Level
 - h. Emergency Procedures
 - i. Program Details

OPERATIONS AND MAINTENANCE SECTION

1. **Fume-hood System Description**
 - a. Fan Curves
 - b. Operational Requirements
2. **Fume-hood Manual**
3. **Fume-hood Alarm Manual**
4. **Room Schematics (including system schematics)**

APPENDIX C**ON-SITE TEST FORMS****C.1 Commissioning Checklist**

Laboratory Fume Hoods		Page 1
Project:	Project No:	Date:
Room:	Type:	Overall sizes:
Fume Hood No. on Contract Dwgs:		
Mfr:	Mfr Serial No.:	MMS Identifier:
Installation: <input type="checkbox"/> Minimum disturbance of smooth air flow into fume hood by passing traffic <input type="checkbox"/> No obstructions to air flow into hood <input type="checkbox"/> Freedom of movement for fume hood user <input type="checkbox"/> All labels firmly attached <input type="checkbox"/> User instructions complete and in place <input type="checkbox"/> Electronic sketch of the room, showing the location of the hood, windows and doors, all major furniture, air supply and return, etc.		
Bypass (if provided): <input type="checkbox"/> Operates as designed	Work Surface: <input type="checkbox"/> Work surface recessed to contain spills	
Baffles: <input type="checkbox"/> Factory settings <input type="checkbox"/> Unalterable by fume hood user <input type="checkbox"/> Position of baffles recorded and dimensioned (mm)	Bottom Airfoil: <input type="checkbox"/> Height fixed (usually 25 mm)	
Sash: <input type="checkbox"/> Freedom of movement <input type="checkbox"/> Locations of stop set to limit maximum operating position (manual override for set-up)	Counterbalance Mechanism: <input type="checkbox"/> Sash moveable from one end <input type="checkbox"/> Sash remains fixed (i.e., no creep)	
Services: <input type="checkbox"/> Corrosion-resistant finish as required <input type="checkbox"/> Electrical: <input type="checkbox"/> Receptacle—correct power <input type="checkbox"/> Connected to emergency power (if required) <input type="checkbox"/> Mechanical: <input type="checkbox"/> Correct gases from each outlet <input type="checkbox"/> Outlets properly identified <input type="checkbox"/> Correct pressure at outlet <input type="checkbox"/> Isolating controls easily accessible <input type="checkbox"/> Correct identification on each outlet		

C.1 Commissioning Checklist (cont'd)

Laboratory Fume Hoods		Page 2
Fire Extinguishing System (if installed):		
<input type="checkbox"/> Tested and operational		
Scrubber System (if installed):		
<input type="checkbox"/> Correct neutralizing agent and concentration for contaminant	<input type="checkbox"/> Reservoir drainage and recharging facilities easily accessible	
<input type="checkbox"/> Fluid pressure developed by pump sufficient for good atomization	<input type="checkbox"/> Control system verified	
<input type="checkbox"/> Atomizing sprays operating properly	<input type="checkbox"/> Pump connected to emergency power (if required)	
<input type="checkbox"/> Spray system drainage operates correctly and is accessible for cleaning	<input type="checkbox"/> Scrubber efficiency tested and verified	
Light Fixture:		
<input type="checkbox"/> Lens sealed	<input type="checkbox"/> Light level verified	
Controls:		
<input type="checkbox"/> Control sequences and alarm systems verified	<input type="checkbox"/> Vapour warning system (if required)	
<input type="checkbox"/> Visual, audible annunciator for power to fume hood system, adequate air flow for fume hood operation	<input type="checkbox"/> Connected to emergency power	
<input type="checkbox"/> Visual and audible alarm for low air flow, audible alarms with muting switches	<input type="checkbox"/> Written instructions available	
Fume Hood Exhaust Air Systems:		
<input type="checkbox"/> Exhaust air flow rate confirmed by TAB	<input type="checkbox"/> Exhaust systems connected to emergency power (if required)	
<input type="checkbox"/> Minimum air flow when sash closed verified at 150 to 375 air changes per hour (see <i>ANSI Z9.5</i>)		
Tests Completed:		
<input type="checkbox"/> AM—As-manufactured	<input type="checkbox"/> Integrated systems tests	
<input type="checkbox"/> AI—As-installed (i.e., after installation)	<input type="checkbox"/> Certificates provided	
Training		
<input type="checkbox"/> Familiarization during installation	<input type="checkbox"/> Hands-on	
<input type="checkbox"/> Classroom	<input type="checkbox"/> Log books prepared and in place	
Installation verified by:	Date:	
Supervisor:	Date:	

C.2 Performance Verification (PV) Report Forms— Hood and Systems

Agency Name
Building Name:
Laboratory:
Date:

Hood Information

Hood ID:	Hood Type:
Manufacturer:	Hood Model:
Serial:	Size:

Hood Design Features

Sash: <input type="checkbox"/> Vertical <input type="checkbox"/> Combination <input type="checkbox"/> Horizontal <input type="checkbox"/> None	Number of Sashes/Panels: _____ Panel Widths _____	Baffle: <input type="checkbox"/> Adjustable <input type="checkbox"/> None <input type="checkbox"/> Fixed
Number of Slots:	Interior Depth:	Internal Construction:
Services:		
General Comments:		

C.2 Performance Verification (PV) Report Forms— Hood and Systems (cont'd)

System Information

System ID:	
Exhaust Type: <input type="checkbox"/> VAV <input type="checkbox"/> CAV <input type="checkbox"/> Other	Exhaust Configuration: <input type="checkbox"/> Single Hood—Single Fan <input type="checkbox"/> Multiple Hood—Multiple Fan <input type="checkbox"/> Single Hood—Multiple Fan <input type="checkbox"/> No Exhaust <input type="checkbox"/> Multiple Hood—Single Fan
Hood Duct Diameter:	Monitor:
Duct Material:	Monitor Type:
Filtration:	Alarm:
Filtration Type:	Damper:
VAV Control Type:	VAV Manufacturer:

C.3 Forms for Test Results—CAV

Agency Name:
Building Name:
Laboratory:
Date:

C.3 Forms for Test Results—CAV (cont'd)

Test Conditions

Sash Opening Description:				
Normal Operating Position Dimensions:	Width: _____ mm	Height: _____ mm	Area: _____ m ²	Total Area: _____ m ²
Baffle Opening:				
Apparatus in Hood:	<input type="checkbox"/> Yes <input type="checkbox"/> No			
Monitor:	Type:	Reading:		
Additional Test Comments:				

C.3.1 Cross Draft Test Results

Horizontal Draft	Left	Centre	Right
Peak m/s			
Average m/s			
Vertical Draft	Left	Centre	Right
Peak m/s			
Average m/s			
Perpendicular Draft	Left	Centre	Right
Peak m/s			
Average m/s			

C.3 Forms for Test Results—CAV (cont'd)

C.3.2 Face Velocity Tests

Face Velocity Traverse Results, Sash at Design Opening

	Col 1	Col 2	Col 3	Col 4	Col 5	Col 6	Col 7	Col 8
Row 1								
Row 2								
Row 3								
Ave. Velocity: ___ m/s Max. Velocity: ___ m/s Min. Velocity: ___ m/s Exhaust Flow: ___ l/s								

Face Velocity Traverse Results, Bypass Effectiveness (Sash at 150 mm)

	Col 1	Col 2	Col 3	Col 4	Col 5	Col 6	Col 7	Col 8
Row 1								
Row 2								
Row 3								
Ave. Velocity: ___ m/s Max. Velocity: ___ m/s Min. Velocity: ___ m/s Exhaust Flow: ___ l/s								

C.3.3 Airflow Visualization

	Diffuser Location #1: _____	Diffuser Location #2: _____	Diffuser Location #3: _____
Observations:			
Time to evacuate smoke (sec.):			
Performance Evaluation:	High Pass: <input type="checkbox"/> Yes <input type="checkbox"/> No Low Pass: <input type="checkbox"/> Yes <input type="checkbox"/> No Low Fail: <input type="checkbox"/> Yes <input type="checkbox"/> No High Fail: <input type="checkbox"/> Yes <input type="checkbox"/> No		
Comments:			

C.3 Forms for Test Results—CAV (cont'd)

C.3.4 Tracer Gas Test Results

Sash at Normal Operating Position: (____ mm H x ____ mm W)

Ejector and Mannequin Position	Left	Centre	Right
Average ppm			
Peak ppm			

Peripheral Scan

Peak Reading, ppm, design sash position:

Sash Movement Effect (sash moving from closed to normal operating position)

	Cycle 1	Cycle 2	Cycle 3
45 second Rolling average			

C.3.5 Fume Hood Monitor, Alarm and Sensors

Calibration: All sensors reporting to BAS calibrated	<input type="checkbox"/> Yes	<input type="checkbox"/> No
Monitor Display: To at least 2 decimal points	<input type="checkbox"/> Yes	<input type="checkbox"/> No
Monitor Accuracy: Display is within +/- 5% of actual value	<input type="checkbox"/> Yes	<input type="checkbox"/> No
Alarm Enunciation: Occurs when beyond +/- 10% of design flow set point	<input type="checkbox"/> Yes	<input type="checkbox"/> No
Alarm Response: Enunciation delay (maximum 10 seconds)	_____ seconds	

C.4 Forms for Test Results—VAV

Identification

Agency Name:
Building Name:
Laboratory:
Date:

Test Conditions

Sash Opening Description:				
Normal Operating Position Dimensions:	Width: _____ mm	Height: _____ mm	Area: _____ m ²	Total Area: _____ m ²
Baffle Opening:				
Apparatus in Hood:	<input type="checkbox"/> Yes <input type="checkbox"/> No			
Monitor:	Type:	Reading:		
Additional Test Comments:				

C.4.1 Cross Draft Test Results

Horizontal Draft	Left	Centre	Right
Peak m/s			
Average m/s			
Vertical Draft	Left	Centre	Right
Peak m/s			
Average m/s			
Perpendicular Draft	Left	Centre	Right
Peak m/s			
Average m/s			

C.4 Forms for Test Results—VAV (cont'd)

C.4.2 Face Velocity Tests

Face Velocity Traverse Results—Design Sash Position

	Col 1	Col 2	Col 3	Col 4	Col 5	Col 6	Col 7	Col 8
Row 1								
Row 2								
Row 3								
Ave. Velocity: ___ m/s Max. Velocity: ___ m/s Min. Velocity: ___ m/s Exhaust Flow: ___ l/s								

Face Velocity Traverse Results—Sash at 66% of Design Sash Position

	Col 1	Col 2	Col 3	Col 4	Col 5	Col 6	Col 7	Col 8
Row 1								
Row 2								
Row 3								
Ave. Velocity: ___ m/s Max. Velocity: ___ m/s Min. Velocity: ___ m/s Exhaust Flow: ___ l/s								

Face Velocity Traverse Results—Sash at 33% of Design Sash Position

	Col 1	Col 2	Col 3	Col 4	Col 5	Col 6	Col 7	Col 8	Col 9	Col 10	Col 11
Row 1											
Row 2											
Row 3											
Ave. Velocity: ___ m/s Max. Velocity: ___ m/s Min. Velocity: ___ m/s Exhaust Flow: ___ l/s											

C.4 Forms for Test Results—VAV (cont'd)

C.4.3 Flow Response

	Cycle 1	Cycle 2	Cycle 3
VAV speed of response: time to reach 90% of the average steady state value			
VAV time to steady state: return to +/- 10% of average face velocity or flow			

Response and Stability Plot

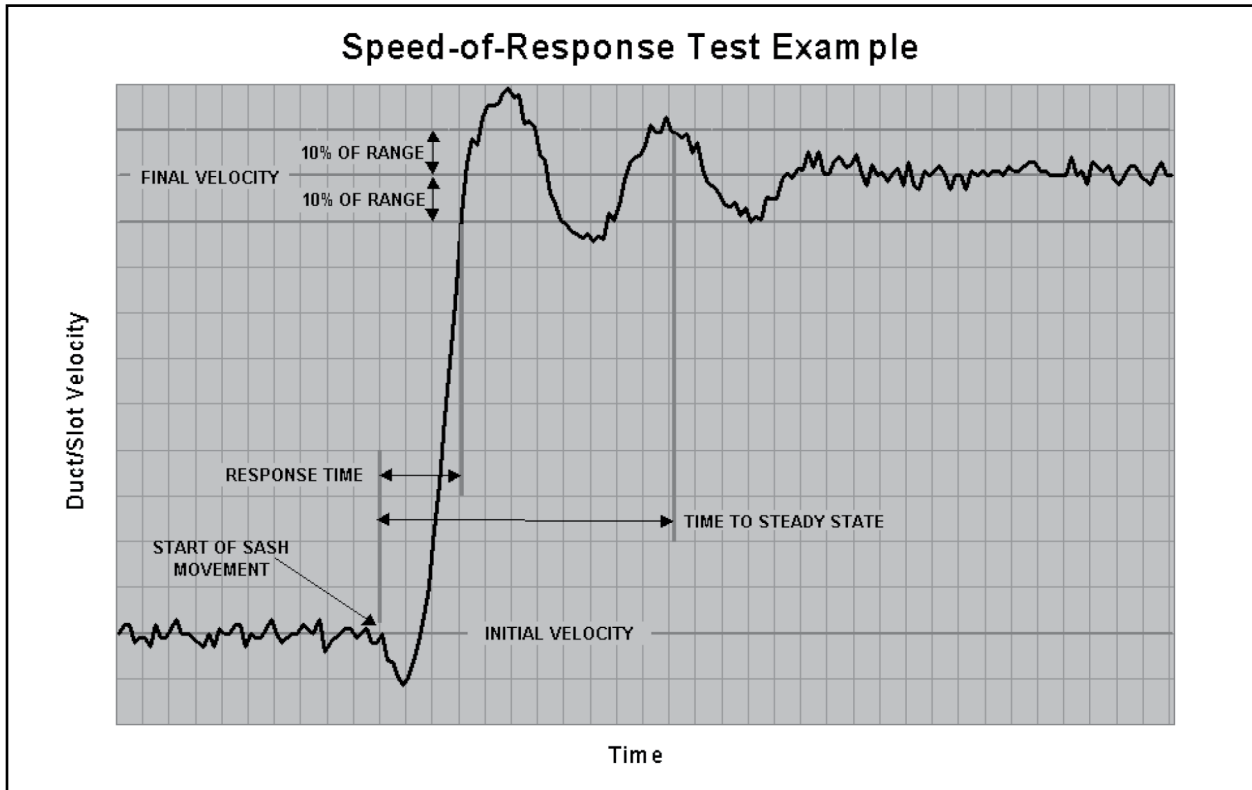

C.4.4 Minimum Flow Test

	Litres per second	Air changes per hour
Airflow with sash closed		

C.4 Forms for Test Results—VAV (cont'd)

C.4.5 Airflow Visualization

	Diffuser Location #1: _____	Diffuser Location #2: _____	Diffuser Location #3: _____
Observations:			
Time to evacuate smoke (sec.):			
Performance Evaluation:	High Pass: <input type="checkbox"/> Yes <input type="checkbox"/> No Low Pass: <input type="checkbox"/> Yes <input type="checkbox"/> No Low Fail: <input type="checkbox"/> Yes <input type="checkbox"/> No High Fail: <input type="checkbox"/> Yes <input type="checkbox"/> No		
Comments:			

C.4.6 Tracer Gas Test Results

Sash at Normal Operating Position

Ejector and Mannequin Position	Left	Centre	Right
Average ppm			
Peak ppm			

Peripheral Scan

Peak Reading, ppm, Design Sash Position:
--

Sash Movement Effect (sash moving from closed to normal operating position)

	Cycle 1	Cycle 2	Cycle 3
45 second Rolling average			

C.4 Forms for Test Results—VAV (cont'd)

C.4.7 Fume Hood Monitor, Alarm and Sensors

Calibration: all sensors reporting to BAS calibrated	<input type="checkbox"/> Yes	<input type="checkbox"/> No
Monitor display: to at least 2 decimal points	<input type="checkbox"/> Yes	<input type="checkbox"/> No
Monitor accuracy: display is within +/- 5% of actual value	<input type="checkbox"/> Yes	<input type="checkbox"/> No
Alarm Annunciation: occurs when beyond +/- 20% of design flow set point	<input type="checkbox"/> Yes	<input type="checkbox"/> No
Alarm Response: Annunciation delay (maximum 10 seconds)	_____ seconds	

C.4.8 Fume Hood Test Summary

Hood ID:
Tester(s):
Date:
Hood Inspection: <input type="checkbox"/> Hood Integrity <input type="checkbox"/> Light Operation <input type="checkbox"/> Monitor Operation <input type="checkbox"/> Sash Operation <input type="checkbox"/> Liner/Baffle Integrity <input type="checkbox"/> Alarm Operation
Comments:

Summary Performance Rating

Rating: <input type="checkbox"/> Pass <input type="checkbox"/> Fail <input type="checkbox"/> N/A <input type="checkbox"/> Restricted Use <input type="checkbox"/> Pass/Fail <input type="checkbox"/> Marginal
Reason—Comments:
General Comments/Recommendations:

C.5 Statement of Conformance

Statement of conformance for Laboratory Fume Hood Testing

We _____ certify that our company/agency conforms to the qualification requirements stated in *Section 6.2 of MD 15128-2013: Laboratory Fume Hoods*.

In particular, the following criteria have been met:

Qualification Criteria	
Minimum of 3 years of experience in the verification of fume hoods	<input type="checkbox"/> Met <input type="checkbox"/> Not Met
Attended the <i>HVAC Systems and Laboratory Design</i> course (by U.S. Eagleson Institute or equivalent)	<input type="checkbox"/> Met <input type="checkbox"/> Not Met
Attended <i>ASHRAE 110: Testing Workshop</i> training by U.S. Eagleson Institute, or <i>Fume Hood Testing Seminar for Certified Professionals</i> by National Environmental Balancing Bureau (NEBB), or equivalent	<input type="checkbox"/> Met <input type="checkbox"/> Not Met
Fully cognizant of contents in <i>MD 15128: Laboratory Fume Hoods</i>	<input type="checkbox"/> Met <input type="checkbox"/> Not Met

Contact Information
Company/Agency Name:
Contact Name:
Address:
Telephone Number:
E-Mail Address:

Please provide details on the following page.

I certify that all of the above statements are correct:

(Date and Place)

(Signature of the Authorized Party)

C.5 Statement of Conformance (cont'd)

Details of How the Qualifications Are Met

Qualification Criteria	Explanation/Examples
<p>Minimum of 3 years of experience in the verification of fume hoods</p> <p><i>Examples of 3 projects for which verification of fume hoods was required:</i></p>	<p>Project name (1):</p> <p>Project date and place:</p> <p>Number of hoods tested:</p> <p>Contact/reference name:</p> <p>Project name (2):</p> <p>Project date and place:</p> <p>Number of hoods tested:</p> <p>Contact/reference name:</p> <p>Project name (3):</p> <p>Project date and place:</p> <p>Number of hoods tested:</p> <p>Contact/reference name:</p>
<p><i>HVAC Systems and Laboratory Design</i> course (by U.S. Eagleson Institute or equivalent)</p>	<p>Name of the Training Institution:</p> <p>Name of the Training Course:</p> <p>Date course taken:</p> <p>Name of the attendee:</p> <p>Copy of the certificate attached: <input type="checkbox"/> Yes <input type="checkbox"/> No</p>
<p><i>ASHRAE 110: Testing Workshop</i> training (by U.S. Eagleson Institute or <i>Fume Hood Testing Seminar for Certified Professionals</i> by National Environmental Balancing Bureau (NEBB), or equivalent)</p>	<p>Name of the Training Institution:</p> <p>Name of the Training Course:</p> <p>Date course taken:</p> <p>Name of the attendee:</p> <p>Copy of the certificate attached: <input type="checkbox"/> Yes <input type="checkbox"/> No</p>

APPENDIX D

FUME HOOD OPERATION, CONTROLS, AND ALARMS

D.1 Dual Speed Exhaust Fans

Laboratory HVAC system designs will sometimes require the use of two-speed fume hood exhaust fans, with a low speed for standby fume hood operation and a high speed for standard operation of each individual fume hood and for maintaining laboratory pressurization requirements.

The high speed should be fixed by pulley selection. The low speed should be achieved using two-speed motors, silicon controlled rectifiers (SCR), rheostats, etc.

The fume hood exhaust fan should be integrated with the HVAC system and should operate at low speed whenever the fume hood is not in use, to provide minimum air flow requirements. At the same time a **RED** pilot light on the monitor should indicate **“FUME HOOD UNSAFE FOR USE”** (since air flow rate is inadequate to meet fume hood face velocity criteria).

To actively use the fume hood, the fume hood user should turn a **“HIGH SPEED/LOW SPEED”** selector switch to **“HIGH SPEED”**. The **RED** pilot light should remain on and an audible alarm should sound until the fume hood exhaust air velocity satisfies the setting of the monitor, at which point the **RED** pilot light and the alarm should both be deactivated and a **GREEN** pilot light should be activated to indicate **“FUME HOOD READY FOR USE.”**

When the fume hood is no longer required, the user should lower the sash to the minimum position and return the selector switch to the **“LOW SPEED”** or **“STANDBY”** position. The exhaust fan should return to low speed, the audible alarm should be removed from the circuit, and the **RED** pilot light should again be energized, indicating **“FUME HOOD UNSAFE FOR USE”**.

If, when in high-speed mode, the exhaust air flow rate varies by $\pm 10\%$ of the alarm sensor setting, the **GREEN** light should be de-energized, the **RED** light should be energized indicating **“FUME HOOD UNSAFE FOR USE,”** and the audible alarm should sound.

A muting switch should provide the option of silencing the audible alarm only. It should automatically reset when adequate airflow rate has been re-established.

The monitor panel at the fume hood may contain all switches and indicator lights within a single unit (preferred), or there may be two separate parts, an operator's panel and a control panel.

D.2 Operator's Panel

The operator's panel should consist of the following:

1. Two-position selector switch labelled "**HIGH**" and "**LOW**".
2. **RED** pilot light labelled "**FUME HOOD UNSAFE FOR USE**".
3. **GREEN** pilot light labelled "**FUME HOOD READY FOR USE**".

D.3 Control Panel

The control panel should contain the following:

1. Pressure switch for airflow monitoring
2. Audible alarm to indicate air flow failure
3. Muting switch to silence audible alarm only
4. Relays for motor and controls

Note: When using dual speed controls, shut-off dampers in the exhaust duct are not normally necessary. If provided, however, they should be integrated into the laboratory HVAC control strategy, except that they should not close upon activation of the building fire alarms.

BIBLIOGRAPHY

The reader shall review and coordinate with the requirements contained in the following related documents:

1. National Building Code of Canada
2. National Fire Code of Canada
3. Canadian Electrical Code
4. CAN/CSA Z316.5-04 (June 2004): *Fume Hoods and Associated Exhaust Systems*
5. CAN/CSA C22.2 n° 61010-1-04: *Safety Requirements for Electrical Equipment for Measurement, Control and Laboratory Use—Part 1: General Requirements*
6. ANSI/ASHRAE 110-1995: *Method of Testing Performance of Laboratory Fume Hoods*
7. NFPA 45-2011: *Standard on Fire Protection for Laboratories Using Chemicals*
8. NFPA 30-2012: *Flammable and Combustible Liquids Code*
9. ANSI/AIHA Z9.5: 2011 *The American National Standard for Laboratory Ventilation*
10. National Research Council (U.S.): *Prudent Practices in the Laboratory: Handling and Management of Chemical Hazards, Updated Version (2011), The National Academy Press*
11. OSHA: *Laboratory Worker Regulation 29 CFR Part 110.1450*
12. ACGIH (American Conference of Governmental Industrial Hygienists): *2004 Industrial Ventilation: A Manual for Recommended Practice for Operation and Maintenance, 25th ed.*
13. ACGIH: *2011 Threshold Limit Values (TLVs) and Biological Exposure Indices (BEIs)*
14. Canadian Nuclear Safety Commission GD-52-2008: *Design Guide for Nuclear Substance Laboratories and Nuclear Medicine Rooms* (supercedes R-52 rev.1: 1991 *Design Guide for Basic and Intermediate Level Radioisotope Laboratories*)
15. ASHRAE RP-969: *2001 Laboratory Design Guide*
16. SEFA 1 (Scientific Equipment and Furniture Association): *2006 Recommended Practices for Laboratory Fume Hoods*
17. SEFA 3 (Scientific Equipment and Furniture Association): *2010 Work Surfaces Recommended Practice*
18. SEFA 9 (Scientific Equipment and Furniture Association): *2010 Recommended Practices for Ductless Enclosures*
19. PWGSC Mechanical Design Guideline MD 15129-2006: *Guidelines for Perchloric Acid Fume Hoods and Exhaust Systems*

20. PWGSC Commissioning Manual and Guidelines, consisting of the following:

CP.1: Commissioning Manual

CP.3: Guide to the Development of the Commissioning Plan

CP.4: Guide to the Preparation of the Building Management Manuals

CP.5: Guide to the Preparation of Training Plans

CP.7: Design Guideline for Facility Operation and Maintenance

CP.8: Guide to the Preparation of Commissioning Reports

CP.9: Guide to the Development of Installation/Start-up Check Lists

CP.10: Guide to the Development of Report Forms and Schematics

CP.11: Guide to the Preparation of the Commissioning Briefs

CP.12: Guide to the Development and Use of Commissioning Specifications

CP.13: Facility Maintenance Policy, Guidelines and Requirements (Draft)

Unless a specific version of the document is listed, the most current version of the document should be consulted.