

NOTES  
 - TIGE EN ALU 6061-T6 200x250x4mm  
 - DIAMÈTRE 200x250x4mm  
 - TIGE EN ALU 6061-T6 200x250x4mm  
 - TIGE EN ALU 6061-T6 200x250x4mm  
 - TIGE EN ALU 6061-T6 200x250x4mm

FOI/POLE	MASSIF	DIMENSIONS	TIGE	D'ANCRAJE	ANCHOR	ROD
L	SEGMENT	D <sub>ext</sub> / D <sub>int</sub> / P / K (mm)	L <sub>k</sub> (mm)	T <sub>ext</sub> / T <sub>int</sub> (mm)	P / K (mm)	J / K (mm)
30	1	12100	12100	12100	1 1/2	8950
	2	7950	7950	7950	1 1/2	8950
	3	592	592	592	1 1/2	8950

PROFIL/PROFILE  
 ECHELLE/SCALE: AUCUNE/NONE

1. SPECIFICATIONS DES FÔTS  
 POLE SPECIFICATION  
 ECHELLE/SCALE: AUCUNE/NONE

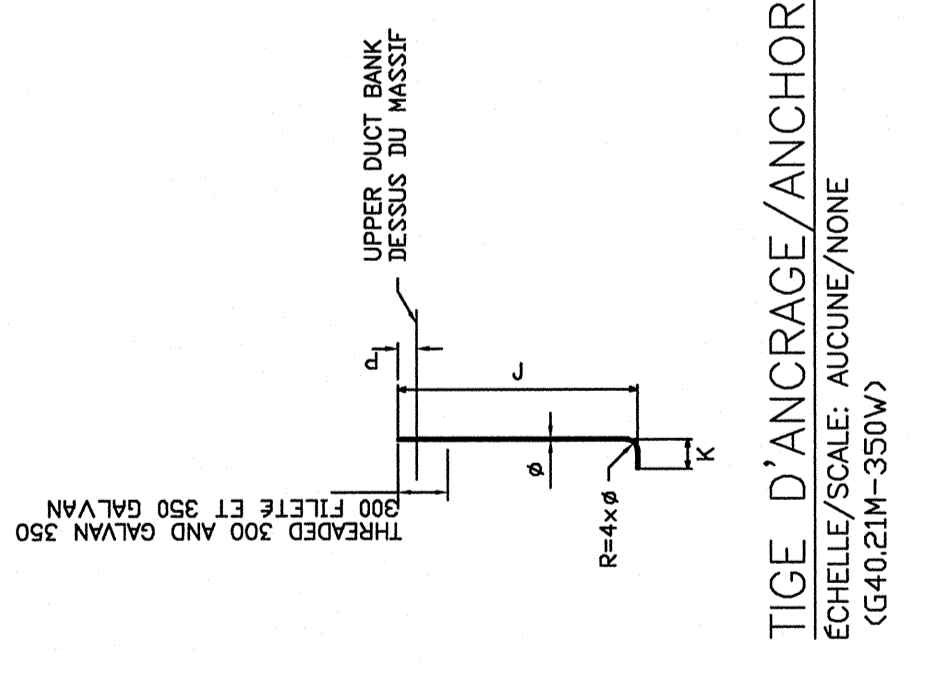

NOTES  
 - TIGE EN ALU 6061-T6 200x250x4mm  
 - DIAMÈTRE 200x250x4mm  
 - TIGE EN ALU 6061-T6 200x250x4mm  
 - TIGE EN ALU 6061-T6 200x250x4mm

FOI/POLE	MASSIF	DIMENSIONS	TIGE	D'ANCRAJE	ANCHOR	ROD
L	SEGMENT	D <sub>ext</sub> / D <sub>int</sub> / P / K (mm)	L <sub>k</sub> (mm)	T <sub>ext</sub> / T <sub>int</sub> (mm)	P / K (mm)	J / K (mm)
30	1	12100	12100	12100	1 1/2	8950
	2	7950	7950	7950	1 1/2	8950
	3	592	592	592	1 1/2	8950

PROFIL/PROFILE  
 ECHELLE/SCALE: AUCUNE/NONE

1. SPECIFICATIONS DES FÔTS  
 POLE SPECIFICATION  
 ECHELLE/SCALE: AUCUNE/NONE

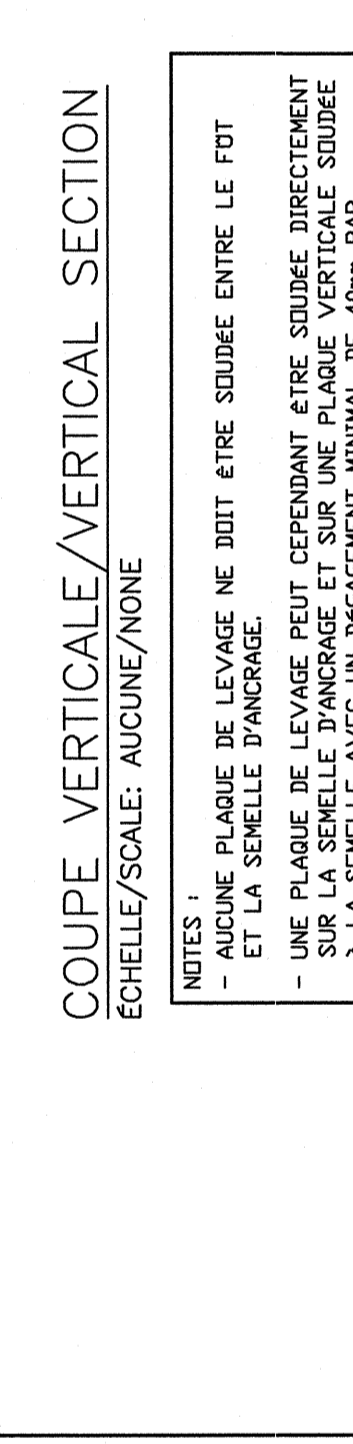
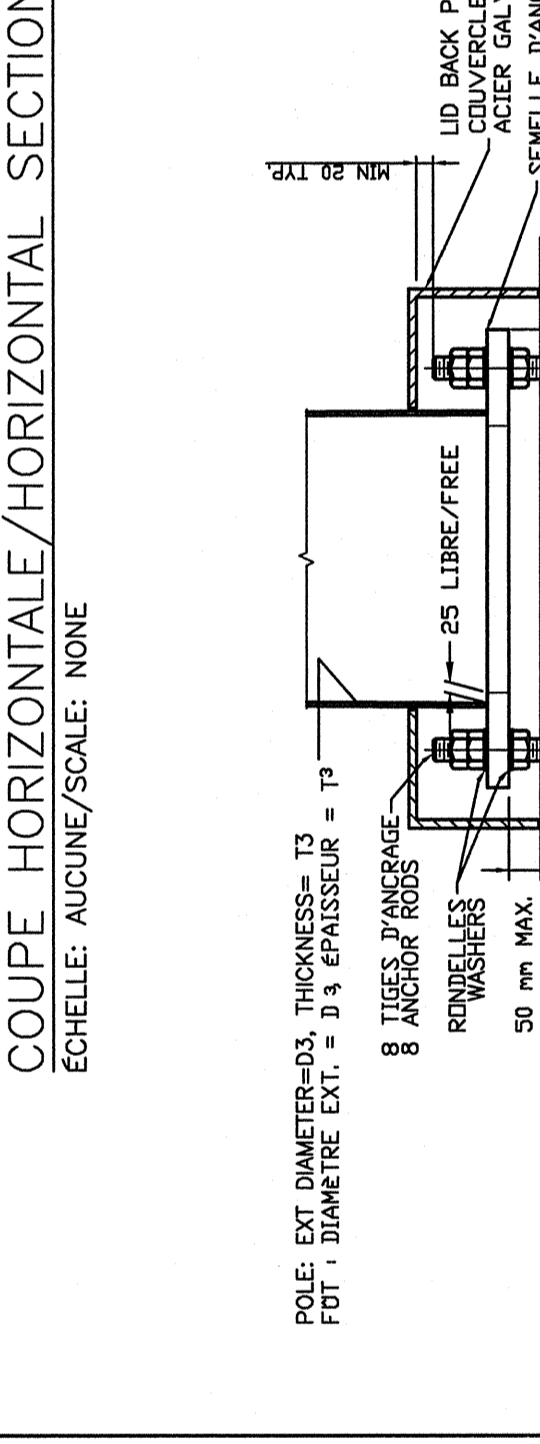
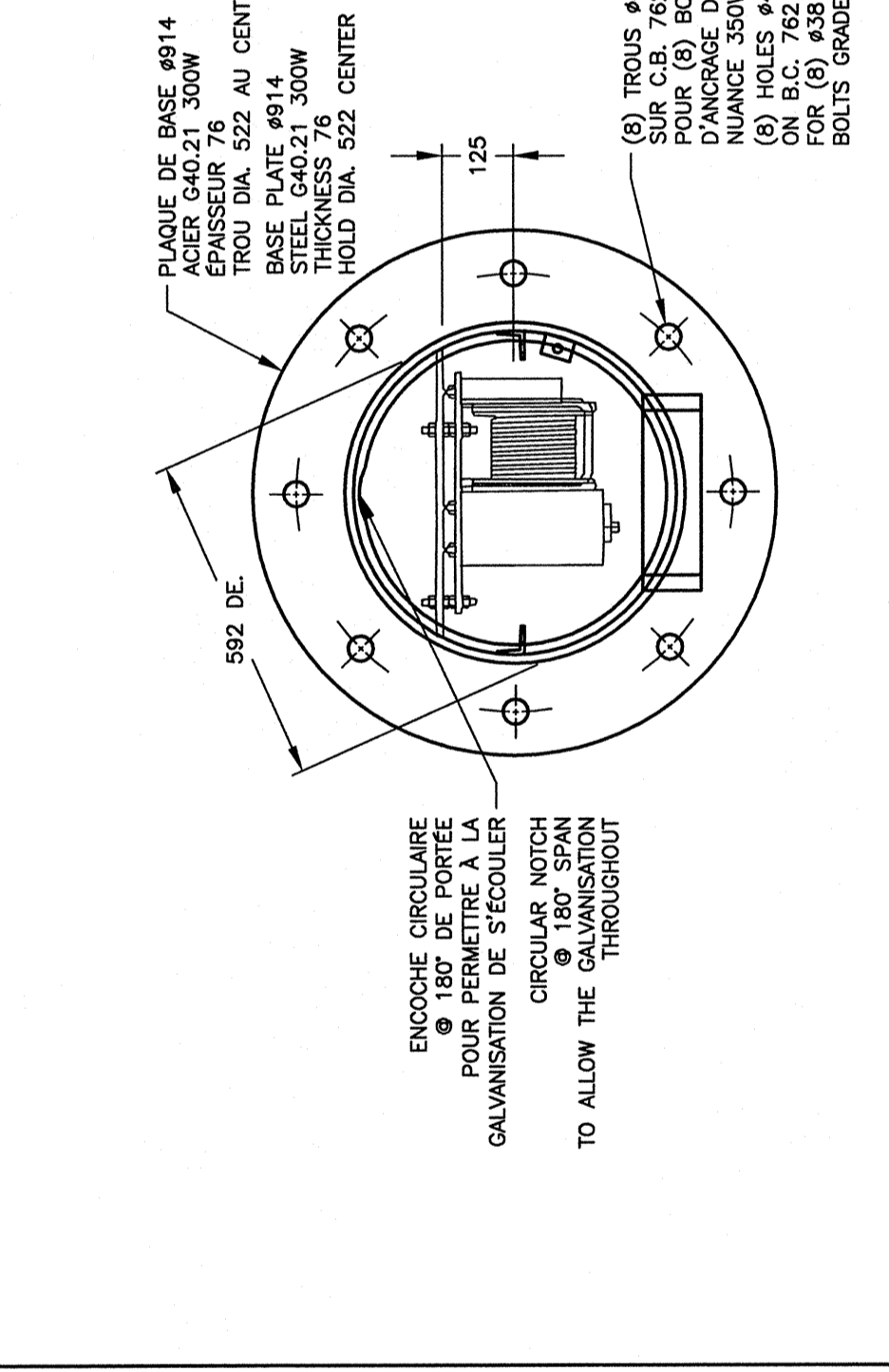

DÉTAIL/DETAIL 1

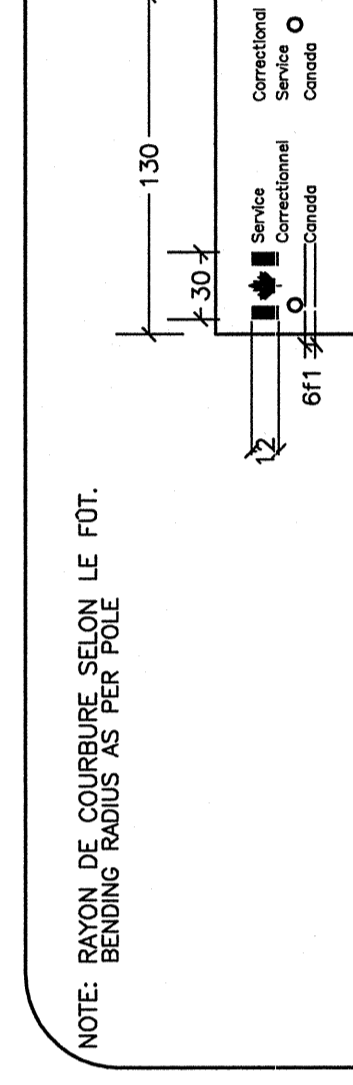
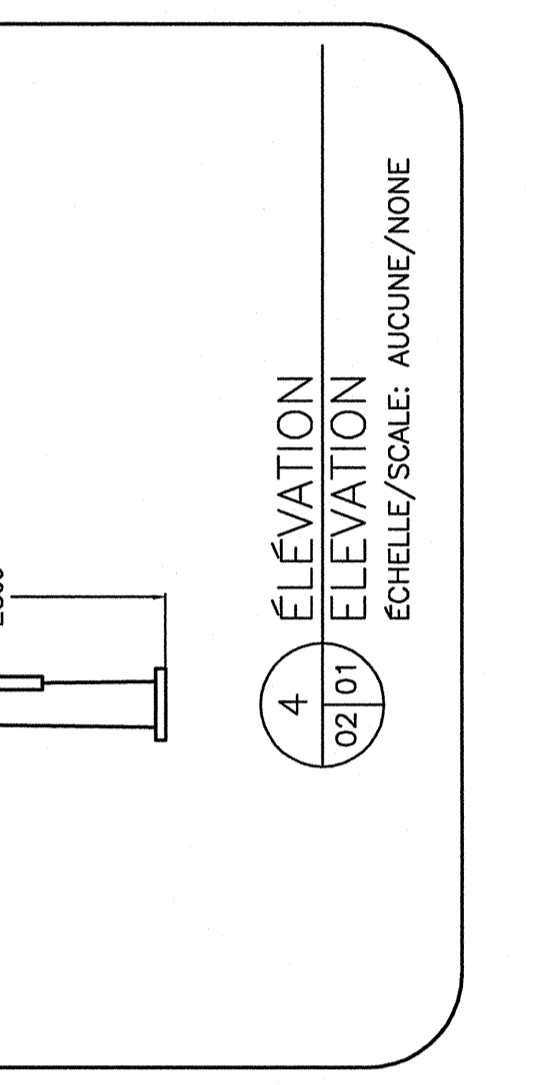
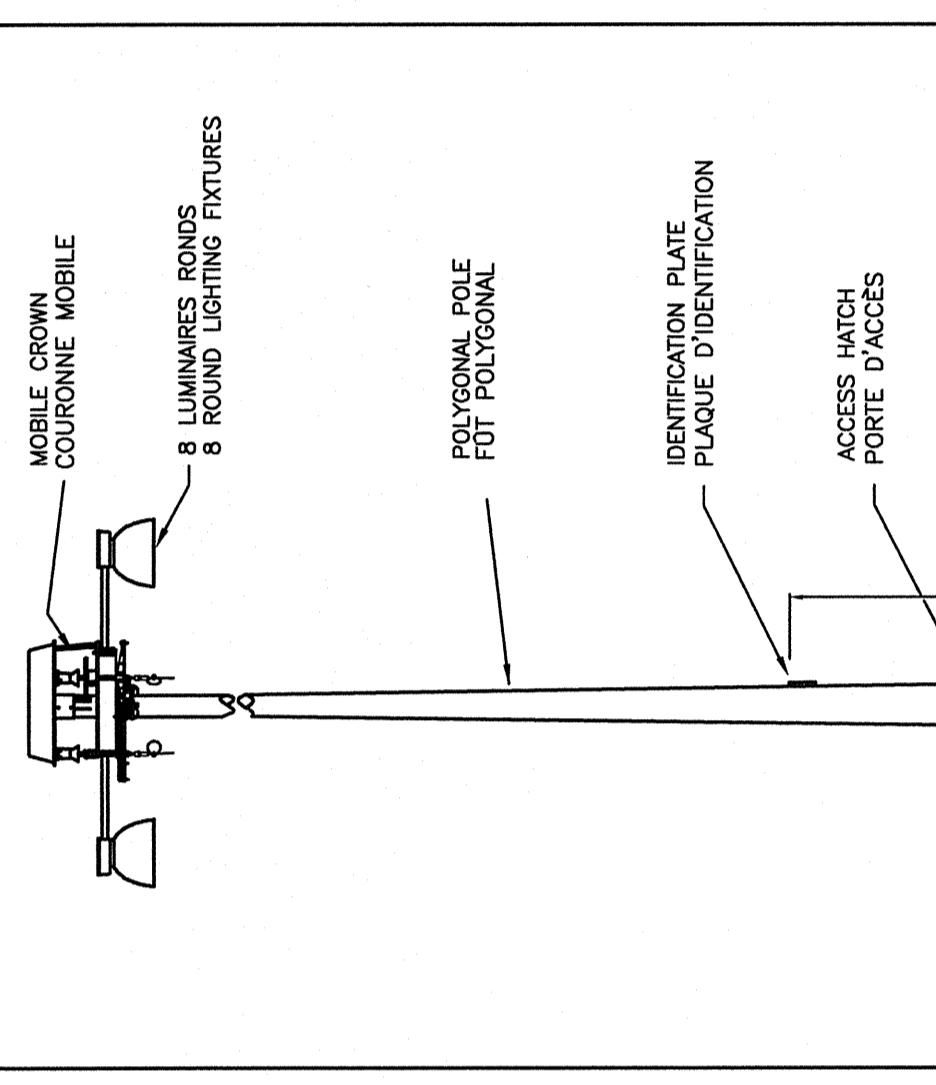

5. IDENTIFICATION DES LAMPADAIRES  
 IDENTIFICATION LAMPPOSTS PLATE  
 ECHELLE/SCALE: AUCUNE/NONE

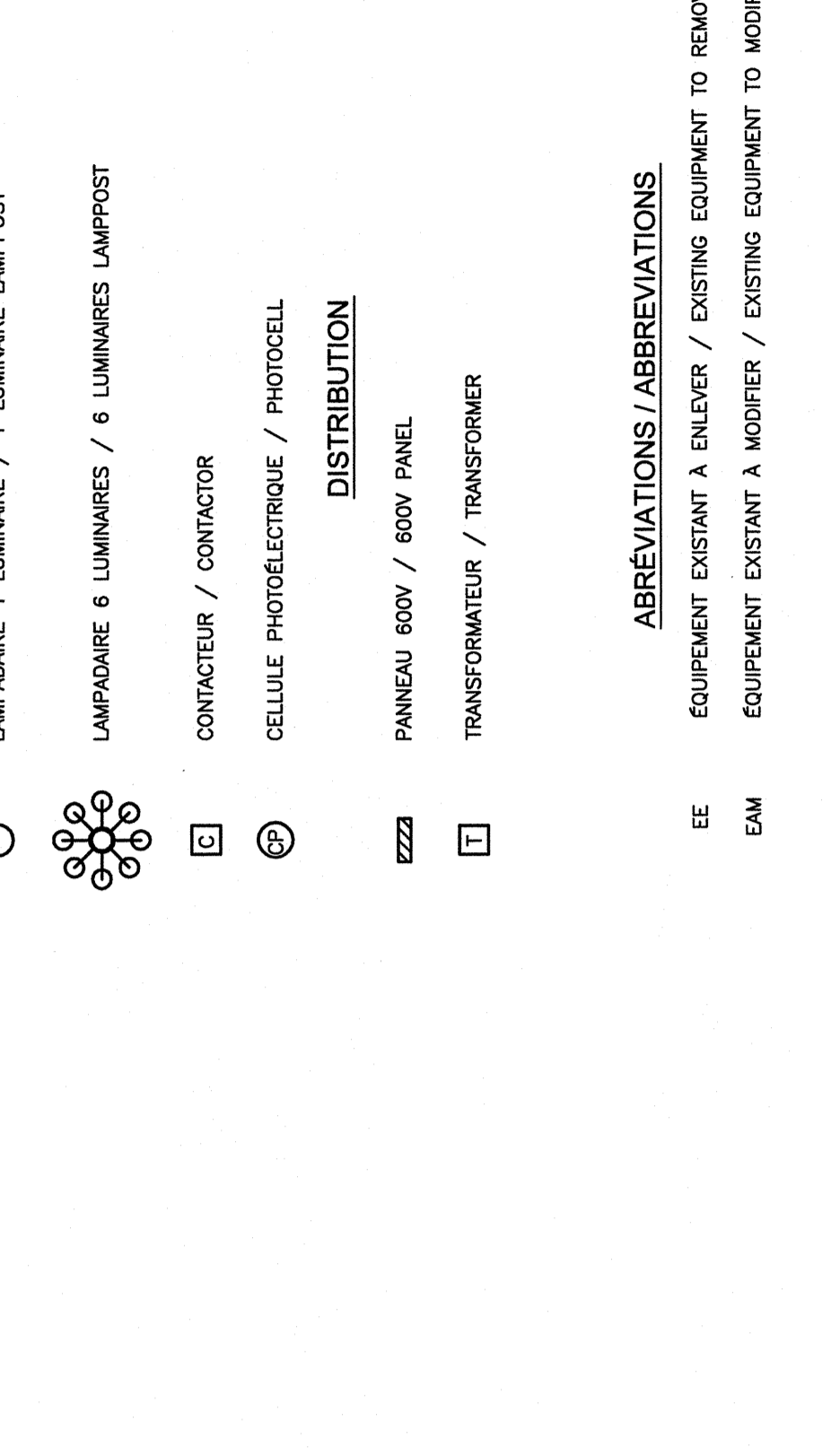

LISTE DES PLANS / DRAWING LIST

NO. DE PLAN	TITRE	ÉCHELLE	STATUT
550-2-343-3920-01-0-ÉDU	ECLAIRAGE EXTÉRIEUR / OUTDOOR LIGHTING	1:1	REVISED
550-2-343-3920-02-0-ÉDU	ECLAIRAGE EXTÉRIEUR / OUTDOOR LIGHTING	1:1	REVISED
550-2-343-3920-03-0-ÉDU	ECLAIRAGE EXTÉRIEUR / OUTDOOR LIGHTING	1:1	REVISED
550-2-343-3920-04-0-ÉDU	ECLAIRAGE EXTÉRIEUR / OUTDOOR LIGHTING	1:1	REVISED

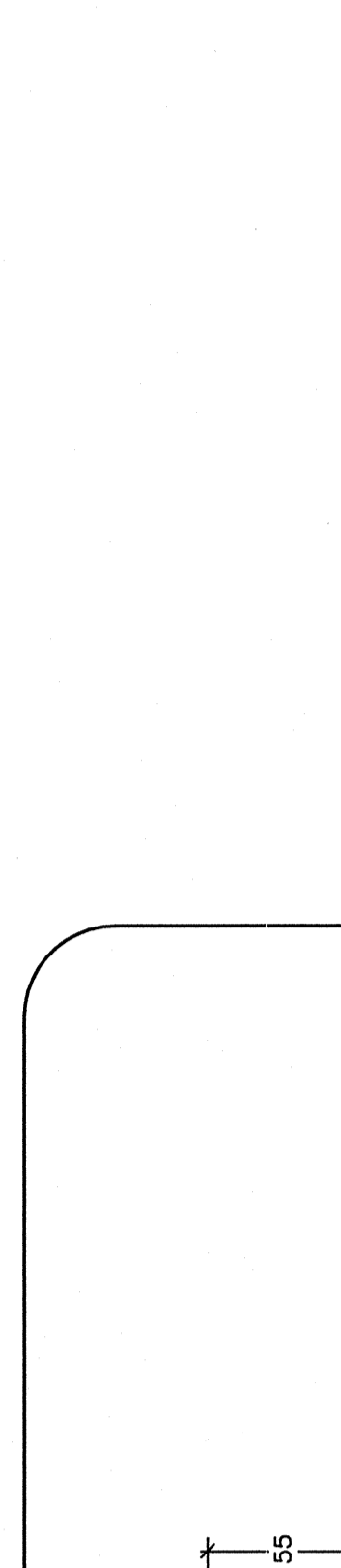

6. COUPE DE TRANCÉE (TYPIQUE)  
 TRENCH SECTION (TYPICAL)  
 ECHELLE/SCALE: AUCUNE/NONE

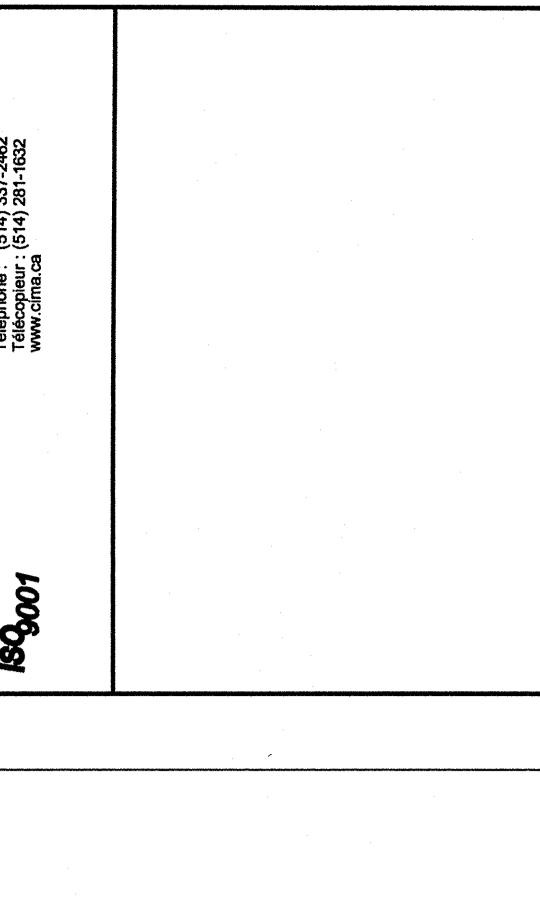
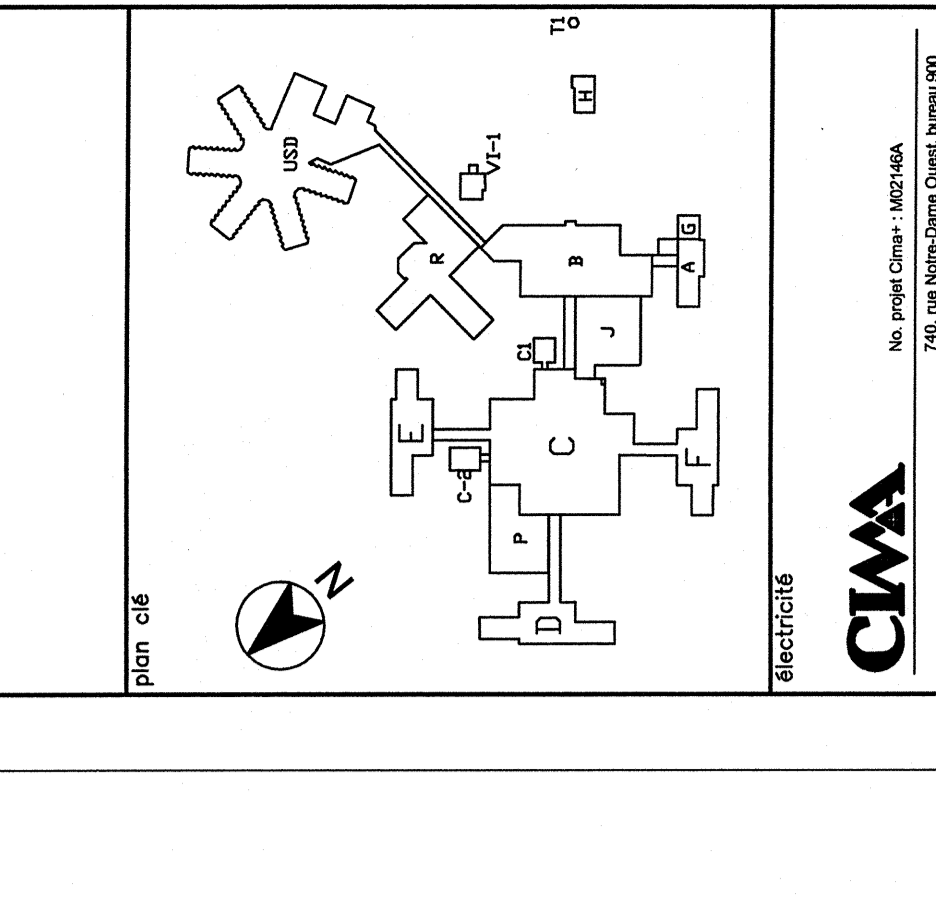

7. INSTALLATION DU LAMPADAIRE (TYPIQUE)  
 LAMPPOST INSTALLATION (TYPICAL)  
 ECHELLE/SCALE: AUCUNE/NONE

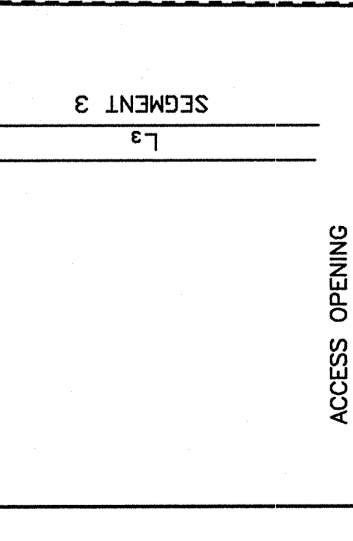
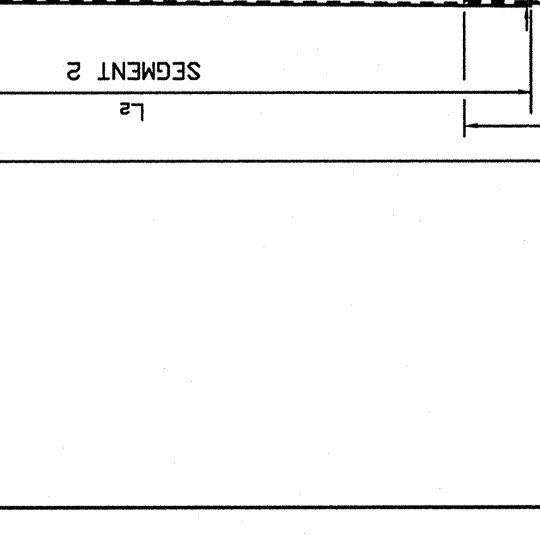
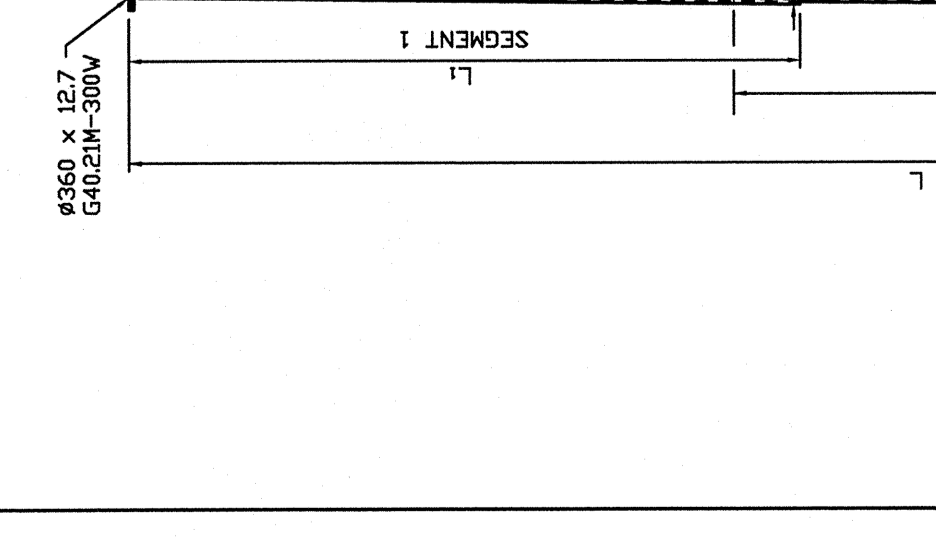

3. PRINCIPE DE RACCORD DES LAMPADAIRES (TYPIQUE)  
 PRINCIPLE OF LAMPPOSTS CONNECTIONS (TYPICAL)  
 ECHELLE/SCALE: AUCUNE/NONE

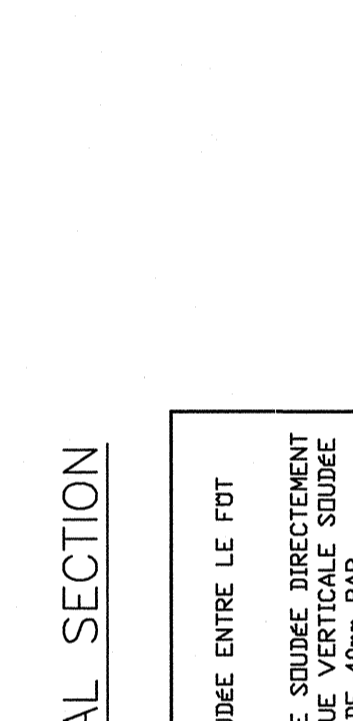
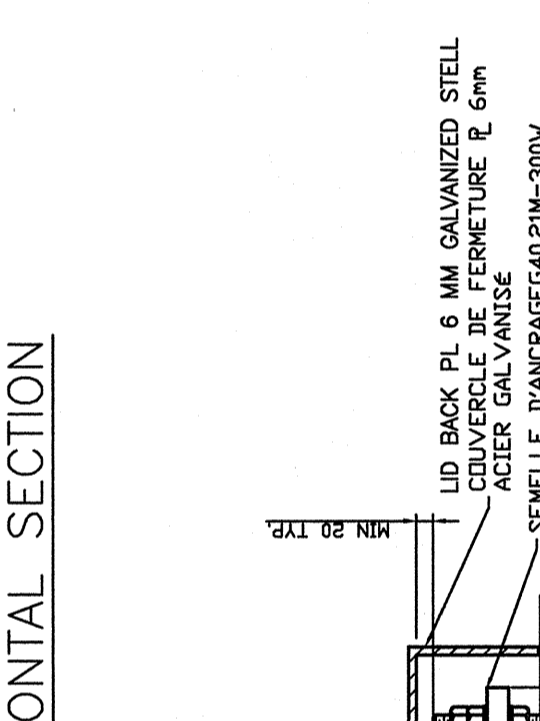
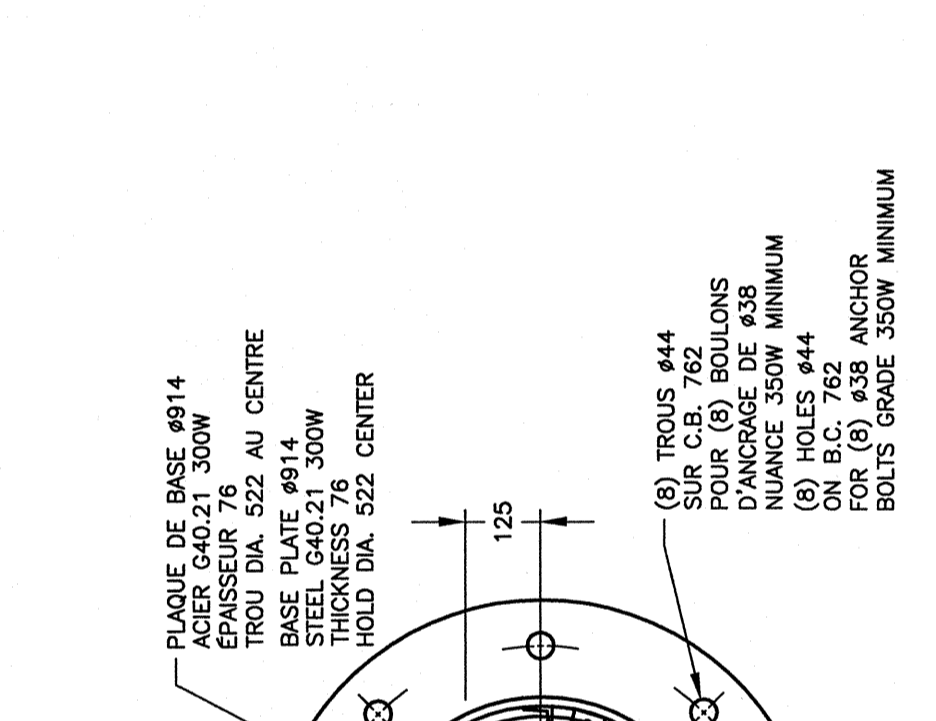

3. PRINCIPE DE RACCORD DES LAMPADAIRES (TYPIQUE)  
 PRINCIPLE OF LAMPPOSTS CONNECTIONS (TYPICAL)  
 ECHELLE/SCALE: AUCUNE/NONE

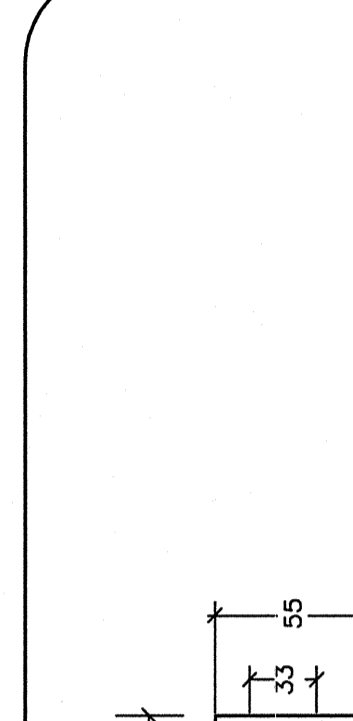
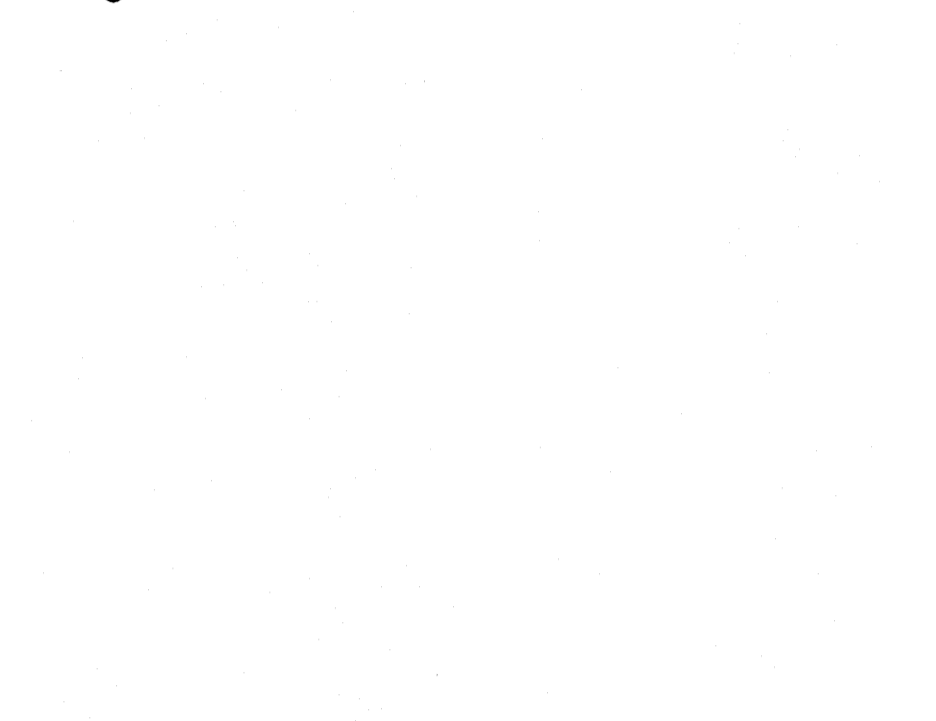

3. PRINCIPE DE RACCORD DES LAMPADAIRES (TYPIQUE)  
 PRINCIPLE OF LAMPPOSTS CONNECTIONS (TYPICAL)  
 ECHELLE/SCALE: AUCUNE/NONE

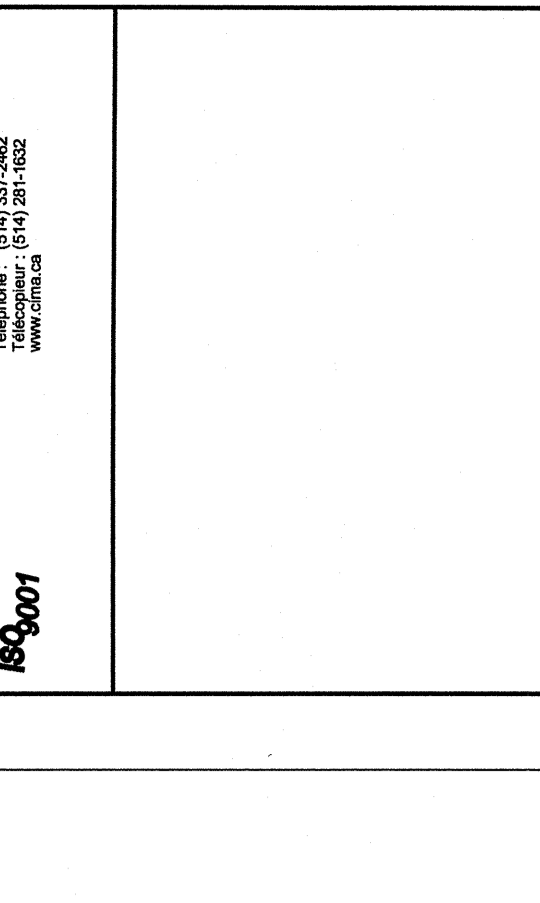
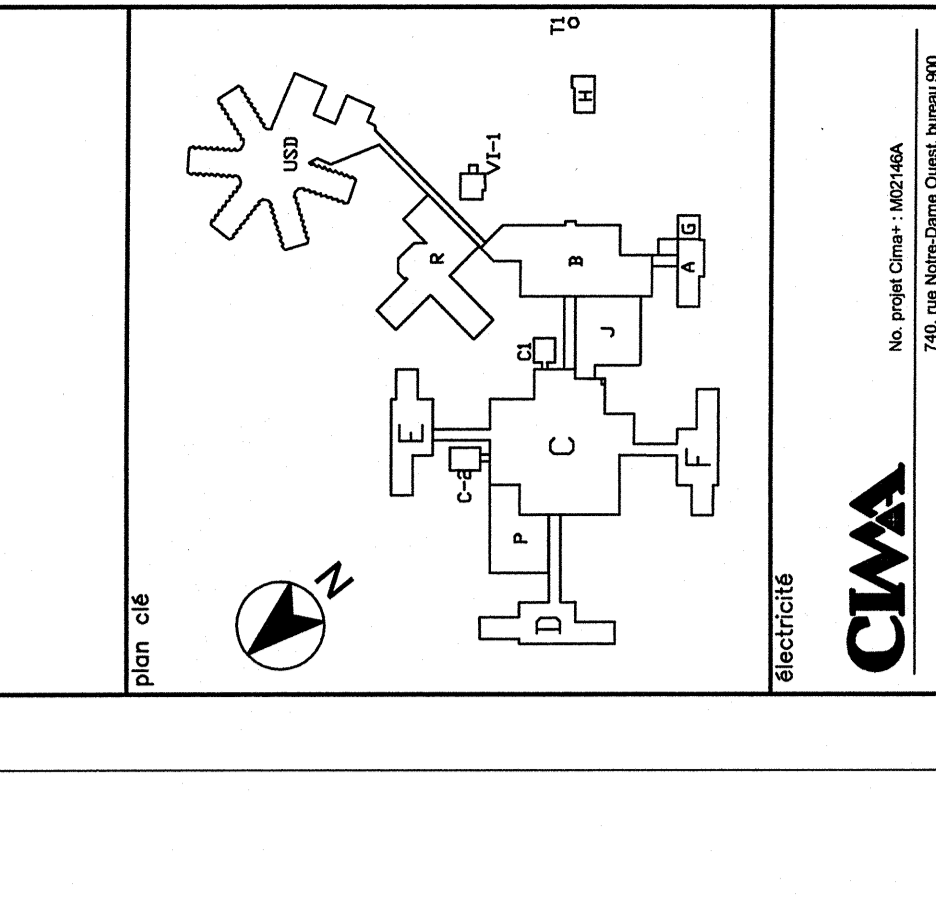

3. PRINCIPE DE RACCORD DES LAMPADAIRES (TYPIQUE)  
 PRINCIPLE OF LAMPPOSTS CONNECTIONS (TYPICAL)  
 ECHELLE/SCALE: AUCUNE/NONE