



Procurement and Contracting Services

30 Victoria Street

Gatineau, Quebec K1A 0M6

proposition-proposal@elections.ca

REQUEST FOR PROPOSAL

The bidder, as identified below, offers to sell to the Chief Electoral Officer of Canada, or any person authorized to act on his/her behalf, in accordance with the terms and conditions set out herein, referred to herein or attached hereto, the goods and services listed herein and on any attached sheets at the prices set out therefore.

Bidder's Name:
Address:
Tel No.:
Fax. No.:
IN WITNESS WHEREOF , the proposal in response to this Request for Proposal has been duly executed on behalf of the bidder by the hands of its officer duly authorized in that behalf

<i>signature of authorized signatory</i>

<i>print name of authorized signatory</i>

<i>print title of authorized signatory</i>
<i>Date:</i> _____

Office of the Chief Electoral Officer File No. ESVT-RFP-14-0366

Title: Printing of Various Envelopes	Date: August 21, 2014
--	-------------------------------------

Request for Proposal Closing Date: September 8, 2014 at 2 PM, Gatineau Time

INQUIRIES – address inquiries to:	
Office of the Chief Electoral Officer of Canada Procurement and Contracting Services 30 Victoria Street Gatineau QC K1A 0M6 proposition-proposal@elections.ca	
Attention: Stella Van Tassel	Tel No. 819-939-1491

RETURN PROPOSALS TO:
Elections Canada Proposal Receiving Unit
c/o Business Centre 30 Victoria Street Gatineau QC K1A 0M6
PROPOSALS TRANSMITTED BY FACSIMILE OR ELECTRONIC MAIL TO ELECTIONS CANADA WILL NOT BE ACCEPTED

This Request for Proposal (“RFP”) contains the following documents:

Part 1 – General Information

Part 2 – Bidder Instructions

Part 3 – Proposal Preparation Instructions

Part 4 – Evaluation Procedures and Basis of Selection

Part 5 – Security, Financial and Other Requirements

Part 6 – Resulting Contract

Annex A – Statement of Work

Annex B – Pricing Table

Annex C – General Conditions – Mixed Goods and Services

Part 7 – Mandatory Technical Evaluation Criteria

Part 8 – Financial Evaluation Criteria

Part 9 – Certificates

Request for Proposal

ECSVT-RFP-14-0366

Part 1. General Information

1.1 Code of Conduct for Procurement

- 1.1.1 To comply with the Code of Conduct for Procurement, bidders must respond to RFPs in an honest, fair and comprehensive manner, accurately reflect their capacity to satisfy the requirements stipulated in the RFP, which includes the resulting Contract, submit proposals and enter into contracts only if they will fulfill all obligations of those contracts.
- 1.1.2 Bidders acknowledge that, to ensure fairness, openness and transparency in the procurement process, the commission of certain acts or offences will render them ineligible to be awarded a contract. Elections Canada will declare non-responsive any proposal in respect of which the information herein requested is missing or inaccurate, or in respect of which the information contained in the certificates contemplated in this Section 1.1 is found to be untrue, in any respect, by Elections Canada. If it is determined, after Contract award, that the bidder made a false declaration or certification, Elections Canada will have the right to terminate for default the resulting Contract. The bidder and any of the bidder's Affiliates will also be required to remain free and clear of any acts or convictions specified herein during the period of any contract arising from this solicitation. Elections Canada may verify the information provided by the bidder, including the information relating to the acts or convictions specified herein, through independent research, use of any government resources or by contacting third parties.
- 1.1.3 By submitting a proposal, the bidder certifies that no one convicted under any of the provisions under Paragraphs 1.1.3(a) or (b) is to receive any benefit under a contract arising from this solicitation. In addition, the bidder certifies that except for those offences where a criminal pardon or a record suspension has been obtained or capacities restored by the Governor in Council, neither the bidder nor any of the bidder's Affiliates has ever been convicted of an offence under any of the following provisions:

- (a) Criminal Code of Canada, R.S.C. 1985, c. C-46:
- i. section 121 (Frauds on the government and contractor subscribing to election fund);
 - ii. section 124 (Selling or Purchasing Office);
 - iii. section 380 (Fraud committed against Her Majesty);
 - iv. section 418 (Selling defective stores to Her Majesty);
 - v. section 462.31 (Laundering proceeds of crime);
 - vi. section 467.11 to 467.13 (Participation in activities of criminal organization);

- (b) Financial Administration Act, R.S.C. 1985, c. F-11:
 - i. paragraph 80(1)(d) (False entry, certificate or return);
 - ii. subsection 80(2) (Fraud against Her Majesty);
 - iii. section 154.01 (Fraud against Her Majesty);
- (c) Competition Act, R.S.C. 1985, c. C-34:
 - i. section 45 (Conspiracies, agreements or arrangements between competitors);
 - ii. section 46 (Foreign directives);
 - iii. section 47 (Bid Rigging);
 - iv. section 49 (Agreements or arrangements of federal financial institutions);
 - v. section 52 (False or misleading representation);
 - vi. section 53 (Deceptive notice of winning a prize);
- (d) Income Tax Act, R.S.C. 1985, c-1:
 - i. section 239 (False or deceptive statements);
- (e) Excise Tax Act, R.S.C. 1985, c. E-15:
 - i. section 327 (False or deceptive statements);
- (f) Corruption of Foreign Public Officials Act, S.C. 1998, c-34:
 - i. section 3 (Bribing a foreign public official);
- (g) Controlled Drugs and Substance Act, S.C. 1996, c-19:
 - i. section 5 (Trafficking in substance);
 - ii. section 6 (Importing and exporting);
 - iii. section 7 (Production of substance).

1.1.4 In circumstances where a criminal pardon or a record suspension has been obtained or capacities restored by the Governor in Council, the bidder must provide with its proposal a certified copy of confirming documentation from an official source. If such documentation has not been received by the time the evaluation of proposals is completed, Elections Canada will inform the bidder of a time frame within which to provide the documentation. Failure to comply will render the proposal non-responsive.

1.1.5 Bidders understand that Elections Canada may contract outside of the present solicitation process with a supplier who has been convicted of an offence enumerated under Paragraphs 1.1.3 (c) to (g), or with an Affiliate who has been convicted of an offence enumerated under Paragraphs 1.1.3 (c) to (g), when required to do so by law or legal proceedings, or when Elections Canada considers it necessary to the public interest for reasons which include, but are not limited to:

- (a) only one person is capable of performing the Contract;
- (b) emergency;

- (c) national security;
- (d) health and safety; or
- (e) economic harm.

Elections Canada reserves the right to impose additional conditions or measures to ensure the integrity of the procurement process.

- 1.1.6 By submitting a proposal, the bidder certifies that neither the bidder nor any of the bidder's Affiliates have directly or indirectly paid or agreed to pay, and will not directly or indirectly pay a contingency fee to any individual for the solicitation, negotiation or obtaining of the Contract if the payment of the fee would require the individual to file a return under section 5 of the *Lobbying Act*.
- 1.1.7 For the purposes of this RFP, an Affiliate means a business concern, organization or individual that, directly or indirectly, 1) either one controls or has the power to control the other, or 2) a third party has the power to control both. Indicia of control, include, but are not limited to, interlocking management or ownership, identity of interests among family members, shared facilities and equipment, common use of employees, or a business entity created following the charges or convictions contemplated in this Section which has the same or similar management, ownership, or principal employees as the bidder that is charged or convicted, as the case may be.
- 1.1.8 The bidder acknowledges and agrees that the certifications contemplated must remain valid during the period of the Contract arising from this RFP.

1.2 Definitions

Unless the context requires otherwise, the capitalized terms used in this RFP shall have the definitions assigned to them in the Contract.

1.3 Summary

The Chief Electoral Officer of Canada ("CEOC"), an agent of Parliament, exercises general direction and supervision over the conduct of elections and referendums at the federal level. The CEOC heads the Office of the Chief Electoral Officer, commonly known as Elections Canada.

1.3.1 The Requirement

This requirement is to provide Elections Canada with high quality printing services for Envelopes as detailed in Annex A – Specifications Group 1 and Group 2.

1.3.2 The Objective

It is the intention of Elections Canada to issue two separate contracts for the envelopes. The requirement has been divided into two Groups as per Annex A - Specifications. Elections Canada will award the contracts to two different Bidders; no single Bidder will be awarded a contract for both Groups.

1.3.3 Period of the Contract

The Contract period will be from Contract award to March 31, 2015

The bidder grants to Elections Canada the irrevocable option to extend the Term of the Contract by one additional period of up to one year under the same terms and conditions.

1.3.4 Delivery Date

All the deliverables must be received on or before October 27, 2014.

1.3.5 Security Requirement

There is no security requirement associated with this solicitation.

1.3.6 Trade Agreements

For requirement subject to trade agreements, the following sentence should be inserted: [Delete from this option the trade agreements that are not applicable.]

The requirement is subject to the provisions of the World Trade Organization Agreement on Government Procurement (WTO-AGP), the Agreement on Internal Trade (AIT), the Canada-Chile Free Trade Agreement, the Canada Colombia Free Trade Agreement, the Canada-Peru Free Trade Agreement and the Canada-Panama Free Trade Agreement.

1.4 Communications Notification

As a courtesy, Elections Canada requests that the successful bidder notify the Contracting Authority in advance of its intention to make public announcements related to the award of a contract.

1.5 Debriefings

Once the successful bidder has been announced, bidders may request a debriefing on the results of the RFP process. Bidders should make the request to the Contracting Authority within 20 calendar days of receipt of the results of the RFP process. The debriefing may be in writing, by telephone or in person.

Part 2. Bidders Instructions

2.1 Instructions and Conditions

Bidders who submit a proposal agree to be bound by the terms and conditions of this RFP and accept the clauses and conditions of the resulting Contract attached as Part 6 to this RFP.

2.2 Procurement Business Number

Canadian suppliers are required to have a Procurement Business Number (PBN) before the Effective Date of the Contract. Suppliers may register for a PBN in the Supplier Registration Information system, on the [buyandsell.gc.ca](https://buyandsell.gc.ca/for-businesses/for-businesses-guide/register-as-a-supplier) Web site (<https://buyandsell.gc.ca/for-businesses/for-businesses-guide/register-as-a-supplier>). For non-Internet registration, suppliers may contact the InfoLine at 1-800-811-1148 to obtain the telephone number of the nearest Supplier Registration Agent.

2.3 Definition of Bidder

For the purposes of this RFP, “bidder” means the person or entity (or, in the case of a joint venture, the persons or entities) submitting a proposal to perform a contract for goods, services or both. It does not include the parent, subsidiaries or other Affiliates of the bidder, or its subcontractors.

2.4 Submission of Proposals

2.4.1 Elections Canada requires that the bidder or the authorized representative of the bidder complete and sign the first page of the RFP and submit such page with its proposal at the RFP closing date and time. If a proposal is submitted by a joint venture, it must be in accordance with Section 2.16. If the first page of the RFP is not provided with the bidder’s proposal, the Contracting Authority will request it and the bidder must provide it within the delay prescribed in such request.

2.4.2 It is the bidder’s responsibility to:

- (a) obtain clarification of the requirements contained in the RFP, if necessary, before submitting a proposal;
- (b) prepare its proposal in accordance with the instructions contained in the RFP;
- (c) submit by the RFP closing date and time a complete proposal;
- (d) send its proposal only to Elections Canada Proposal Receiving Unit specified on page 1 of this RFP (“Proposal Receiving Unit”). The Proposal Receiving Unit is open from 8:00 a.m. to 4:00 p.m. Monday to Friday and closed on all statutory holidays;

- (e) ensure that the bidder's name, return address, the RFP number, and RFP closing date and time are clearly visible on the envelope or the parcel(s) containing the proposal; and,
- (f) provide a comprehensible and sufficiently detailed proposal, including all requested pricing details, that will permit a complete evaluation in accordance with the criteria set out in the RFP.

- 2.4.3 If Elections Canada has provided bidders with multiple formats of a document that forms part of the RFP (for example, a document may be downloaded through the Government Electronic Tendering Service (GETS) but may also be made available on CD-ROM through GETS), the format downloaded through GETS will take precedence. If Elections Canada posts an amendment to the RFP revising any documents provided to bidders in multiple formats, Elections Canada will not necessarily update all formats to reflect these revisions. It is the bidder's responsibility to ensure that revisions made through any RFP amendment issued through GETS are taken into account in those alternate formats that were not revised as a result of an amendment.
- 2.4.4 Proposal will remain open for acceptance for a period of not less than 60 calendar days from the RFP closing date. Elections Canada reserves the right to seek an extension of the proposal validity period from all responsive bidders in writing, within a minimum of three (3) calendar days before the end of the proposal validity period. If the extension is accepted by all responsive bidders, Elections Canada will continue with the evaluation of the proposals. If the extension is not accepted by all responsive bidders, Elections Canada will, at its sole discretion, either continue with the evaluation of the proposals of those who have accepted the extension or cancel the RFP.
- 2.4.5 Proposal documents and supporting information may be submitted in either English or French.
- 2.4.6 Proposals received on or before the stipulated RFP closing date and time will become the property of Elections Canada and will not be returned. All proposals will be treated as confidential, subject to the provisions of the *Access to Information Act*, R.S. 1985, c. A-1 and the *Privacy Act*, R.S. 1985, c. P-21.
- 2.4.7 Unless specified otherwise in the RFP, Elections Canada will evaluate only the documentation provided with a bidder's proposal. Elections Canada will not evaluate information such as references to Web site addresses where additional information can be found, or technical manuals or brochures not submitted with the proposal.
- 2.4.8 A proposal cannot be assigned or transferred in whole or in part.

2.5 Transmission by Facsimile and Email

2.5.1 Proposals transmitted by facsimile or electronic mail to Elections Canada will not be accepted.

2.6 Late Proposals

Elections Canada will return proposals delivered after the stipulated RFP closing date and time, unless they qualify as a delayed proposal as described in Section 2.7.

2.7 Delayed Proposals

2.7.1 A proposal delivered to the Proposal Receiving Unit after the RFP closing date and time but before the announcement of the successful bidder or before a contract is entered into may be considered, provided the bidder can prove the delay is due solely to a delay in delivery that can be attributed to the Canada Post Corporation (CPC) (or national equivalent of a foreign country). Purolator Inc. is not considered to be part of CPC for the purposes of delayed proposals. The only pieces of evidence relating to a delay in the CPC system that are acceptable to Elections Canada are:

- (a) a CPC cancellation date stamp;
- (b) a CPC Priority Courier bill of lading; or
- (c) a CPC Xpresspost label,

that clearly indicates that the proposal was mailed before the RFP closing date.

2.7.2 Misrouting, traffic volume, weather disturbances, labour disputes or any other causes for the late delivery of proposals are not acceptable reasons for the proposal to be accepted by Elections Canada.

2.7.3 Postage meter imprints, whether imprinted by the bidder, the CPC or the postal authority outside Canada, are not acceptable as proof of timely mailing.

2.8 Customs Clearance

It is the responsibility of the bidder to allow sufficient time to obtain customs clearance, where required, before the RFP closing date and time. Delays related to the obtaining of customs clearance cannot be construed as “undue delay in the mail” and will not be accepted as a delayed proposal under Section 2.7.

2.9 Legal Capacity

The bidder must have the legal capacity to contract. If the bidder is a sole proprietorship, a partnership or a corporate body, the bidder must provide, if requested by the Contracting Authority, a statement and any requested supporting documentation indicating the laws under which it is

registered or incorporated together with the registered or corporate name and place of business. This also applies to bidders submitting a proposal as a joint venture.

2.10 Rights of Elections Canada

Elections Canada reserves the right to:

- (a) reject any or all proposals received in response to the RFP;
- (b) enter into negotiations with bidders on any or all aspects of their proposals;
- (c) accept any proposal in whole or in part without negotiations;
- (d) cancel the RFP at any time;
- (e) reissue the RFP;
- (f) if no responsive proposals are received and the requirement is not substantially modified, reissue the RFP by inviting only the bidders that had submitted a proposal to resubmit proposals within a period designated by Elections Canada; and
- (g) negotiate with the sole responsive bidder to ensure best value to Elections Canada.

2.11 Rejection of Proposal

2.11.1 Elections Canada may reject a proposal where any of the following circumstances is present:

- (a) the bidder is bankrupt or where, for whatever reason, its activities are rendered inoperable for an extended period;
- (b) evidence, satisfactory to Elections Canada, of fraud, bribery, fraudulent misrepresentation or failure to comply with any law protecting individuals against any manner of discrimination, has been received with respect to the bidder, any of its employees or any subcontractor included as part of the proposal;
- (c) evidence, satisfactory to Elections Canada, that based on past conduct or behavior, the bidder, a subcontractor or a person who is to perform the Work is unsuitable or has conducted himself/herself improperly;
- (d) Elections Canada has exercised its contractual remedies of suspension or termination for default with respect to a contract with the bidder, any of its employees or any subcontractor included as part of the proposal; and

- (e) Elections Canada determines that the bidder's performance on other contracts, including the efficiency and workmanship as well as the extent to which the bidder performed the Work in accordance with those contracts, is sufficiently poor to jeopardize the successful completion of the requirement of this RFP.

2.11.2 Where Elections Canada intends to reject a proposal pursuant to a provision of Subsection 2.11.1, the Contracting Authority will so inform the bidder and provide the bidder ten (10) calendar days within which to make representations, before making a final decision on the rejection of the proposal.

2.11.3 Elections Canada reserves the right to apply additional scrutiny, in particular, when multiple proposals are received in response to a solicitation from a single bidder or a joint venture. Elections Canada reserves the right to:

- (a) reject any or all of the proposals submitted by a single bidder or joint venture if their inclusion in the evaluation has the effect of prejudicing the integrity and fairness of the process; or
- (b) reject any or all of the proposals submitted by a single bidder or joint venture if their inclusion in the procurement process would distort the solicitation evaluation, and would cause a result that would not reasonably have been expected under prevailing market conditions and/or would not provide good value to Elections Canada.

2.12 Communication – Solicitation Period

2.12.1 To ensure the integrity of the competitive procurement process, enquiries and other communications regarding the RFP must be directed only to the Contracting Authority identified in the RFP. Failure to comply with this requirement may result in the proposal being declared non-responsive.

2.12.2 To ensure consistency and quality of information provided to bidders, and subject to Section 2.19, enquiries received and the replies to such enquiries that result in clarifications or modifications to the requirement or that provide additional information related to the requirement will be provided simultaneously to bidders to which the RFP has been sent, without revealing the sources of the enquiries.

2.13 Price Justification

2.13.1 In the event that the bidder's proposal is the sole responsive proposal received, the bidder must provide, on Elections Canada's request, a fair price certification, in the form prescribed by Elections Canada, whereby the bidder certifies that the price offered to Elections Canada for the goods or services:

- (a) is not in excess of the lowest price charged to anyone else, including the bidder's most favoured customer, for the like quality and quantity of the goods, services or

both;

- (b) does not include an element of profit on the sale in excess of that normally obtained by the bidder on the sale of goods, services or both of like quality and quantity; and
- (c) does not include any provision for discounts to selling agents.

2.13.2 Bidders must submit the fair price certification as well as any documentation supporting the fair price certification within the delay prescribed in the request issued pursuant to Subsection 2.13.1. Failure to comply with the request within such delay may result in the proposal being declared non-responsive.

2.14 Proposal Costs

No payment will be made for costs incurred in the preparation and submission of a proposal in response to the RFP. Costs associated with preparing and submitting a proposal, as well as any costs incurred by the bidder associated with the evaluation of the proposal, are the sole responsibility of the bidder.

2.15 Conduct of Evaluation

2.15.1 In conducting its evaluation of the proposals, Elections Canada may, but will have no obligation to, do the following:

- (a) seek clarification or verification from bidders regarding any or all information provided by them with respect to the RFP;
- (b) contact any or all references supplied by bidders to verify and validate any information submitted by them;
- (c) request, before the award of any contract, specific information with respect to bidders' legal status;
- (d) conduct a survey of bidders' facilities and/or examine their technical, managerial, and financial capabilities to determine if they are adequate to meet the requirements of the RFP;
- (e) correct any error in the extended pricing of proposals by using unit pricing and any error in quantities in proposals to reflect the quantities stated in the RFP; in the case of error in the extension of prices, the unit price will govern;
- (f) verify any information provided by bidders through independent research, use of any government resources or by contacting third parties; and

- (g) interview, at the sole costs of bidders, any bidder and/or any or all of the resources proposed by bidders to fulfill the requirement of the RFP.

2.15.2 Bidders must comply with any request related to any of the items listed in Subsection 2.15.1 within the delay prescribed in such request. Failure to comply with the request may result in the proposal being declared non-responsive.

2.16 Joint Venture

2.16.1 A joint venture is an association of two or more parties who combine their money, property, knowledge, expertise or other resources in a single joint business enterprise, sometimes referred as a consortium, to submit together a proposal on a requirement. Bidders who submit a proposal as a joint venture must indicate clearly that it is a joint venture and provide the following information:

- (a) the name of each member of the joint venture;
- (b) the PBN of each member of the joint venture;
- (c) the name of the representative of the joint venture, i.e. the member chosen by the other members to act on their behalf, if applicable; and
- (d) the name of the joint venture, if applicable.

2.16.2 If the information is not clearly provided in the proposal, the bidder must provide the information on request from the Contracting Authority within the delay prescribed in such request.

2.16.3 The first page of the RFP and the Contract must be signed by all the members of the joint venture unless one member has been appointed to act on behalf of all members of the joint venture. The Contracting Authority may, at any time, require each member of the joint venture to confirm that the representative has been appointed with full authority to act as its representative for the purposes of the RFP and the Contract. If a contract is awarded to a joint venture, all members of the joint venture will be jointly and severally liable for the performance of the Contract.

2.17 Conflict of Interest – Unfair Advantage

2.17.1 In order to protect the integrity of the procurement process, bidders are advised that Elections Canada may reject a proposal in the following circumstances:

- (a) if the bidder, any of its subcontractors, any of their respective employees or former employees was involved in any manner in the preparation of the RFP or in any situation of conflict of interest or appearance of conflict of interest;

- (b) if the bidder, any of its subcontractors, any of their respective employees or former employees had access to information related to the RFP that was not available to other bidders and that would, in Elections Canada's opinion, give the bidder an unfair advantage.

- 2.17.2 The experience acquired by a bidder who is providing or has provided the goods and services described in the RFP (or similar goods or services) will not, in itself, be considered by Elections Canada as conferring an unfair advantage or creating a conflict of interest, subject however, if such bidders trigger any of the circumstances identified in Paragraphs 2.17.1(a) and (b).
- 2.17.3 Where Elections Canada intends to reject a proposal under this Section, the Contracting Authority will inform the bidder and provide the bidder an opportunity to make representations before making a final decision. Bidders who are in doubt about a particular situation should contact the Contracting Authority before the RFP closing date. By submitting a proposal, the bidder represents that it does not consider itself to be in conflict of interest nor to have an unfair advantage. The bidder acknowledges that it is within Elections Canada's sole discretion to determine whether a conflict of interest, unfair advantage or an appearance of conflict of interest or unfair advantage exists.

2.18 Entire Requirement

The RFP contains all the relevant information relating to the requirement. Any other information or documentation provided to or obtained by a bidder from any source are not relevant to this RFP. Bidders should not assume that practices used under previous contracts will continue, unless they are described in the RFP. Bidders should also not assume that their existing capabilities meet the requirements of the RFP simply because they have met previous requirements.

2.19 Enquiries

- 2.19.1 All enquiries must be submitted in writing to the Contracting Authority no later than ten calendar days before the RFP closing date. Enquiries received after that time may not be answered.
- 2.19.2 Bidders should reference as accurately as possible the numbered item of the RFP to which the enquiry relates. Care should be taken by bidders to explain each question in sufficient detail in order to enable Elections Canada to provide an accurate answer. Technical enquiries that are of a proprietary nature must be clearly marked "proprietary" at each relevant item. Items identified as "proprietary" will be treated as such except where Elections Canada determines that the enquiry is not of a proprietary nature. Elections Canada may edit the questions or may request that the bidder do so, so that the proprietary nature of the question is eliminated, and the enquiry can be answered with copies to all bidders. Enquiries not submitted in a form that can be distributed to all bidders may not be answered by Elections Canada.

2.20 Applicable Laws

- 2.20.1 The Contract must be interpreted and governed, and the relations between the parties determined, by the laws in force in Ontario, subject always to any paramount or applicable federal laws.
- 2.20.2 Bidders may, at their discretion, substitute the applicable laws of a Canadian province or territory of their choice without affecting the validity of their proposal, by indicating in their proposal the name of the Canadian province or territory of their choice. If no change is made, it acknowledges that the laws of Ontario are acceptable to the bidder.

Part 3. Proposal Preparation Instructions

3.1. Proposal Preparation Instructions

- 3.1.1 Elections Canada requests that bidders provide their proposal in separately bound sections as follows:
- Section I: Technical Proposal – one hard copy
 - Section II: Financial Proposal – one hard copy
 - Section III: Certifications – one hard copy
- 3.1.2 Prices must appear in the financial proposal only. No prices must be indicated in any other section of the proposal.
- 3.1.3 Elections Canada requests that bidders follow the format instructions described below in the preparation of their proposal:
- (a) use 8.5 x 11 inch (216 mm x 279 mm) paper; and
 - (b) use a numbering system that corresponds to the RFP.
- 3.1.4 In the event that a bidder fails to provide the numbers of copies required pursuant to Subsection 3.1.1, the Contracting Authority will contact the bidder and provide the bidder with a time frame within which to meet the requirement. Failure to comply with the request of the Contracting Authority and meet the requirement within that time period will render the proposal non-responsive.
- 3.1.5 To assist in reaching the objective set out in the Policy on Green Procurement, bidders are encouraged to:

- (a) use paper containing fibre certified as originating from a sustainably managed forest and/or containing a minimum 30% recycled content; and
- (b) use an environmentally preferable format including black and white printing instead of colour printing, printing double sided/duplex, using staples or clips instead of
- (c) cerlox, duotangs or binders.

3.2. Section I – Technical Proposal

3.2.1 In their technical proposal, bidders should respond clearly to the Mandatory Technical Evaluation Criteria contained in Part 7 confirming that they will meet the requirements detailed in Annex A – Specifications – Group 1 and Group 2 for Group for which they are submitting a proposal.

3.3. Section II – Financial Proposal

Bidders must submit their financial proposal in accordance with Part 8 – Financial Evaluation Criteria. The total amount of applicable sales tax must be shown separately, if applicable.

3.4. Section III – Certificates

- 3.4.1. The certificates under Part 9 must be completed by the bidder in accordance with this Section 3.4. Bidders must provide the required certifications to be awarded a contract. Elections Canada will declare a proposal non-responsive if the required certifications are not completed and submitted as requested.
- 3.4.2. Bidders' compliance with the certifications provided to Elections Canada is subject to verification by Elections Canada during the proposal evaluation period and after award of a contract. The Contracting Authority will have the right to ask for additional information to verify bidders' compliance with the certifications before award of a contract. The proposal will be declared non-responsive if any certification made by the bidder is untrue, whether made knowingly or unknowingly. Failure to comply with the certifications or to comply with the request of the Contracting Authority for additional information will also render the proposal non-responsive.
- 3.4.3. The certificates under Part 9 should be completed and submitted with the proposal but may be submitted afterwards. If any of these required certificates is not completed and submitted as requested, the Contracting Authority will so inform the bidder and provide the bidder with a time frame within which to meet the requirement. Failure to comply with the request of the Contracting Authority and meet the requirement within that time period will render the proposal non-responsive.

Part 4. Evaluation Procedures and Basis of Selection

4.1. General Evaluation Procedures

- 4.1.1 Proposals will be assessed in accordance with the entire requirement of the RFP including the mandatory technical and financial evaluation criteria.
- 4.1.2 An evaluation team composed of representatives of Elections Canada will evaluate the proposals.

4.2. Mandatory Technical Evaluation

- 4.2.1 The mandatory technical evaluation criteria are set out in Part 7 – Mandatory Technical Evaluation Criteria.

4.3. Financial Evaluation

- 4.3.1 The mandatory financial evaluation criteria are set out in Part 8 – Financial Evaluation Criteria group 1 and Group 2.

4.4. Basis of Selection

- 4.4.1 A proposal must comply with all the requirements of the RFP and meet all mandatory technical evaluation criteria. If it is determined that a proposal does not comply with any of the requirements of the RFP, such proposal will be deemed non-responsive and will not be given further consideration. The responsive proposal with the lowest evaluated price will be considered for award of a contract.
- 4.4.2 The evaluation and selection process will be conducted in the following phases:

Phase 1 – Mandatory Technical Evaluation

Phase 2 – Financial Evaluation - Determination of Highest Ranked Bidder

In the event evaluators are made aware of information in one Phase that contradicts information contained in a previous Phase, evaluators reserve the right to re-evaluate that portion of the previous Phase and adjust the previously adjudicated score accordingly. If such re-evaluation results in the bidder's proposal being non-responsive for the re-evaluated Phase, the proposal will be assessed as non-responsive and given no further consideration.

4.4.3 Phase 1 – Mandatory Technical Evaluation

In Phase 1, all proposals will be evaluated for their compliance with the mandatory technical evaluation criteria set out in Part 7 – Mandatory Technical Evaluation Criteria. Any proposal

that fails to meet any of the mandatory technical evaluation criteria will be deemed non-responsive and will not be given further consideration.

4.4.4 Phase 2 – Financial Evaluation– Determination of Highest Ranked Bidder

4.4.5 In Phase 2, the proposals that are deemed responsive in Phase 1 will be evaluated against the mandatory financial evaluation criteria set out in Part 8 – Financial Evaluation Criteria.

4.4.6 The prices used in the evaluation will be the Total Evaluated Cost for each of the two Groups detailed below:

- a) Envelopes - Group 1 - Total cost for this grouping of envelopes (initial quantity plus options)
- b) Envelopes - Group 2 - Total cost for this grouping of envelopes (initial quantity plus options)

4.4.7 The price of the proposal will be evaluated in Canadian dollars. Applicable sales tax must be excluded. Canadian customs duties and excise taxes are, where applicable, to be included.

4.4.8 Evaluation will be a two-step process. The bids for Group 1 will be evaluated and the successful bidder will be determined as follows:

- a) if the successful Bidder for Group 1 did not bid on Group 2, the bids that were submitted for Group 2 will be evaluated and a winner will be determined or;
- b) if the successful bidder for Group 1 has also submitted a bid for Group 2, their bid for Group 2 will be set aside and the remaining bids will be evaluated to determine the winner of the contract for Group 2.

Note: Bidders may submit one bid for either Group 1 or Group 2, or they may submit two bids, one for Group 1 and one for Group 2. As detailed above, each bid will be evaluated separately.

4.4.8.1 If more than one bidder is ranked first because of identical prices, then the bidder offering the best delivery date will become the highest ranked bidder and will be considered for the award of a contract.

Part 5. Financial and Other Requirements

5.1 Insurance Requirements

- 5.1.1 Bidders are responsible for deciding if insurance coverage is necessary to fulfill the obligations under the resulting Contract to ensure compliance with any applicable law. Any insurance acquired or maintained by bidders is at their own expense and for their own benefit and protection. It does not release the successful bidder from or reduce its liability under the resulting Contract.

5.2 Condition of Material

- 5.2.1 Material supplied must be new and conform to the latest issue of the applicable drawing, specification and/or part number that is in effect on the RFP closing date.

Part 6 – Resulting Contract



Procurement and Contracting Services
 30 Victoria Street, Gatineau, Quebec K1A 0M6

CONTRACT

The Contractor, as identified below, agrees to sell to the Chief Electoral Officer of Canada, or any person authorized to act on his behalf, in accordance with the terms and conditions set out herein, referred to herein or attached hereto, the goods or services listed herein and on any attached sheets at the prices set out therefore.

Return one signed copy of the Contract forthwith.

Contractor's Name and Address:

[insert Contractor's LEGAL NAME and ADDRESS at contract award]

Contract No.:

[insert at contract award]

Title: [insert at contract award]	Date of Contract: [insert at contract award]
Term of Contract: [insert at contract award]	Financial Code: [insert at contract award]
Total Estimated Cost (incl. applicable sales tax): [insert at contract award]	Applicable sales tax: [insert at contract award]

ENQUIRIES & INVOICES

Office of the Chief Electoral Officer of Canada
 30 Victoria Street
 Gatineau QC K1A 0M6

Contract enquiries to:

[insert name and title at contract award] Procurement and Contracting Services	Tel No.:
	E-mail:

Send invoices to:

[insert name, title and sector at contract award]	Tel No.:
	E-mail:

IN WITNESS WHEREOF, this Contract has been duly executed by the Chief Electoral Officer of Canada by his duly authorized representative and by the Contractor by the hands of its officer duly authorized in that behalf.

<p>[Insert contractor's LEGAL NAME]</p> <p>_____</p> <p>(signature of authorized representative)</p> <p>_____</p> <p>(print name of authorized representative)</p> <p>_____</p> <p>(print title of authorized representative)</p> <p>Date: _____</p>	<p>Chief Electoral Officer</p> <p>_____</p> <p>(signature of authorized representative)</p> <p>[Insert name of authorized representative]</p> <p>[Insert title of authorized representative]</p> <p>Procurement and Contracting Services</p> <p>Date: _____</p>
--	--

ARTICLES OF AGREEMENT

Article 1 Interpretation

Section 1.01 Definitions

1.01.01 In the Contract, unless the context otherwise requires:

“Business Day”	means a day other than a Saturday, Sunday or statutory holiday in the province of Quebec;
“Effective Date”	means the date stated as the “Date of the Contract” on the first page of the Contract;
“General Conditions”	means the general conditions for mixed goods and services attached hereto as Annex C;
“Initial Term”	has the meaning ascribed to in Section 3.01;
“Pricing Table”	means the table attached hereto as Annex B;
“SPOC”	means the Contractor’s single point of contact referred to in Section 5.01 of the Articles of Agreement;
“SOW”	means the statement of work attached hereto as Annex A and the appendices referred to therein, if any; and
“Term”	means the Initial Term and any additional periods resulting from Elections Canada exercising its irrevocable option to extend the period of the Contract provided for in Section 3.02 of the Articles of Agreement.

1.01.02 The definitions of words and terms in the annexes and appendices apply to capitalized words and terms used in these Articles of Agreement as if those words and terms were defined herein.

1.01.03 The headings used in the Contract are inserted for convenience of reference only and shall not affect their interpretation.

ARTICLES OF AGREEMENT

1.01.04 In the Contract, words importing the singular number include the plural and vice versa, and words importing the masculine gender include the feminine gender and the neuter.

Section 1.02 Priority of Documents

1.02.01 The following annexes are attached to and form an integral part of this Contract. If there is a discrepancy between the wordings of any documents that appear on the list, the wording of the document that first appears on the list has priority over the wording of any document that subsequently appears on the list.

1. these Articles of Agreement;
2. Annex A – Statement of Work;
3. Annex B – Pricing Table;
4. Annex C – General Conditions;
5. the Contractor's proposal, dated [insert date of proposal at contract award].

Article 2 Statement of Work

2.01.01 The Contractor must perform the Work in accordance with the SOW.

Article 3 Period of Contract

Section 3.01 Term

3.01.01 The Contract period will be from August 19, 2014 to March 31, 2015.

Section 3.01 Option to extend

3.01.01 The Contractor will grant to Elections Canada irrevocable options to extend the period of the Contract by one additional period of one year under the same terms and conditions.

3.01.02 Elections Canada may exercise these options at any time by sending a written notice to the Contractor at least 15 calendar days before to the Contract expiry date or any extension thereof.

ARTICLES OF AGREEMENT

- 3.01.03 The options to extend the term of the Contract may be exercised only by the Contracting Authority.

Article 4 Authorities

Section 4.01 Contracting Authority

- 4.01.01 The Contracting Authority for the Contract is:

[insert at contract award]

Procurement and Contracting Services
Elections Canada
30 Victoria Street
Gatineau QC K1A 0M6
Tel: 819-
Fax: 819-
E-mail:

- 4.01.02 The Contracting Authority is responsible for the management of the Contract, and any changes to the Contract must be authorized in writing by the Contracting Authority. The Contractor must not perform work in excess of or outside the scope of the Contract based on verbal or written requests or instructions from anybody other than the Contracting Authority.
- 4.01.03 Elections Canada may change the name of the representative designated as Contracting Authority by sending a written notice to the Contractor.

Section 4.02 Technical Authority

- 4.02.01 The Technical Authority for the Contract is:

[insert at contract award]

Elections Canada
Tel: 819-
Fax: 819-
E-mail:

- 4.02.02 The Technical Authority named above is the representative of Elections Canada and is responsible for all matters concerning the technical content of the Work under the Contract. Technical matters may be discussed with the Technical Authority; however, the Technical Authority has no authority to authorize changes to the scope of the

ARTICLES OF AGREEMENT

Work. Changes to the scope of the Work can be made only through a contract amendment issued by the Contract Authority.

- 4.02.03 Elections Canada may change the name of the representative designated as Technical Authority by sending a written notice to the Contractor.

Article 5 Contractor's Representative

Section 5.01 Single Point of Contact

- 5.01.01 SPOC between the Contractor and Elections Canada is:

[Note to Bidders]

Bidders are to provide in their proposal the name, title, telephone number, facsimile number and e-mail address of its representative which will be included in this Section at contract award.

- 5.01.02 The SPOC must liaise with the Contracting Authority and the Technical Authority and will be the first point of contact in terms of:
- (a) managing any business issues with the Technical Authority and any Contract issues with the Contracting Authority and, in particular, providing guidance, support and coordination relative to requests;
 - (b) managing the day-to-day operational issues and technical requirements and, in particular, providing support and coordination relative to service; and
 - (c) meeting, as required, with Elections Canada on issues relating to this Contract, including, without limiting the generality of the foregoing, to review the performance of the service, suggest improvements and assist in analyzing statistical data.

Article 6 Basis of Payment

Section 6.01 Contract Price

- 6.01.01 The Contractor will be paid for the Work in accordance with the Pricing Table.

Section 6.02 Limitation of Expenditure

- 6.02.01 Elections Canada's total liability to the Contractor under the Contract must not

ARTICLES OF AGREEMENT

exceed \$_____ [insert at contract award]. Customs duties are included and any applicable sales tax is extra.

6.02.02 No increase in the total liability of Elections Canada or in the price of the Work resulting from any design changes, modifications or interpretations of the Work, will be authorized or paid to the Contractor unless these design changes, modifications or interpretations have been approved in writing, by the Contracting Authority before their incorporation into the Work. The Contractor must not perform any work or provide any services that would result in Elections Canada's total liability being exceeded before obtaining the written approval of the Contracting Authority.

6.02.03 With respect to the amount set out in Subsections 6.02.01 the Contractor must notify the Contracting Authority in writing as to the adequacy of such amount:

(a) when it is 75 percent committed, or

(b) four months before the Contract expiry date, or

(c) as soon as the Contractor considers that the contract funds provided are inadequate for the completion of the Work,

whichever comes first.

6.02.04 If the notification is for inadequate contract funds, the Contractor must provide to the Contracting Authority a written estimate for the additional funds required. Provision of such information by the Contractor does not increase Elections Canada's liability.

Section 6.03 Authors Alterations and Other Direct Expenses

6.03.01 The Contractor will be reimbursed for authors alterations and the direct expenses reasonably and properly incurred in the performance of the Work. These expenses will be paid at actual cost without mark-up, upon submission of an itemized statement supported by copies of the invoices, receipts and vouchers.

6.03.02 All authors alterations and direct expenses must be approved in advance by the Technical Authority. All payments are subject to audit.

6.03.03 Subject to Subsection 6.04.01, the maximum cost of any authors alterations or the direct expenses is \$[insert at contract award].

ARTICLES OF AGREEMENT

Section 6.04 Applicable Sales Tax

6.04.01 The estimated amount of sales tax, if applicable, is included in the total estimated cost specified on page 1 of the Contract. The applicable sales tax is not included in the Contract Price, but will be paid by Elections Canada as provided in Article 8 – Payments. The Contractor agrees to remit to the appropriate government agency any amounts of applicable sales tax paid or due.

Article 7 Information Reporting

Section 7.01 Form T1204

7.01.01 Pursuant to paragraph 221(1)(d) of the *Income Tax Act*, R.S. 1985, c. 1 (5th Supp.), payments made by departments and agencies, which includes Elections Canada, to contractors under applicable services contracts (including contracts involving a mix of goods and services) must be reported on a T1204 Government Service Contract Payments slip.

7.01.02 To enable Elections Canada to comply with this requirement, the Contractor must provide the following information within 15 calendar days following the award of the Contract:

- (a) the legal name of the Contractor, i.e. the legal name associated with its business number or Social Insurance Number (SIN), as well as its address and postal code;
- (b) the status of the Contractor, i.e. an individual, a sole proprietorship, a corporation, or a partnership;
- (c) the business number of the Contractor if the Contractor is a corporation or a partnership and the SIN if the Contractor is an individual or a sole proprietorship. In the case of a partnership, if the partnership does not have a business number, the partner who has signed the Contract must provide its SIN; and
- (d) in the case of a joint venture, the business number of all parties to the joint venture who have a business number or their SIN if they do not have a business number.

7.01.03 The information must be sent to the Contracting Authority. If the information includes a SIN, the information should be provided in an envelope marked “PROTECTED”.

Article 8 Payment and Invoices

ARTICLES OF AGREEMENT

Section 8.01 Payment

8.01.01 Elections Canada will pay the Contractor on a monthly basis for that part of the Work performed during the month covered by the invoice in accordance with the Contract if:

- (a) an accurate and complete invoice and any other documents required by the Contract have been submitted in accordance with the invoicing instructions provided in the Contract;
- (b) all such documents have been verified by Elections Canada; and
- (c) the Work performed has been accepted by Elections Canada.

Section 8.02 Invoices

8.02.01 The Contractor must submit invoices in accordance with the section entitled “Invoice Submission” of the General Conditions. Invoices cannot be submitted until all Work identified in the invoice is completed.

8.02.02 Each invoice must be supported by:

- (a) a copy of time sheets to support the time claimed if the basis of payment set out in Article 6 is based on hourly rates;
- (b) any other documents or progress reports as specified in the Contract to substantiate the Work performed; and
- (c) a copy of the invoices, receipts and vouchers for all authorized travel and living expenses and other direct expenses.

8.02.03 The original and one copy of each invoice along with one copy of the supporting documentation identified in Subsection 8.02.02 must be forwarded to the address shown on page 1 of the Contract for certification and payment.

Article 9 Security Requirement

9.01.01 There is no security requirement applicable to this Contract.

Article 10 Insurance

ARTICLES OF AGREEMENT

Section 10.01 Insurance

10.01.01 The Contractor is responsible for deciding if insurance coverage is necessary to fulfill its obligation under the Contract and to ensure compliance with any applicable law. Any insurance acquired or maintained by the Contractor is at its own expense and for its own benefit and protection. It does not release the Contractor from or reduce its liability under the Contract.

Article 11 Applicable Laws

Section 11.01 Applicable Laws

[Note to Bidders and Contracting Authority]

If the bidder has identified another province or territory in its proposal, this Section will be modified accordingly at contract award.

11.01.01 The Contract must be interpreted and governed by and construed in accordance with the laws of the province of Ontario and the laws of Canada therein.

Article 12 Certificates

Section 12.01 Certificates

12.01.01 Compliance with the certifications provided by the Contractor in its proposal (the "Certificates") is a condition of the Contract and subject to verification by Elections Canada during the Term. If the Contractor does not comply with any certification or it is determined that any certification made by the Contractor in the Certificates is untrue, whether made knowingly or unknowingly, Elections Canada has the right, pursuant to the default provision of the Contract, to terminate the Contract for default.

Article 13 Foreign Nationals

[Note to Bidders]

Either Option 1 or Option 2 will form part of the resulting contract, depending if the successful bidder is a Canadian contractor or a foreign contractor.

ARTICLES OF AGREEMENT

OPTION 1

The Contractor must comply with Canadian immigration requirements applicable to foreign nationals entering Canada to work temporarily in fulfillment of the Contract. If the Contractor wishes to hire a foreign national to work in Canada to fulfill the Contract, the Contractor should immediately contact the nearest Service Canada regional office to enquire about Citizenship and Immigration Canada's requirements to issue a temporary work permit to a foreign national. The Contractor is responsible for all costs incurred as a result of non-compliance with immigration requirements.

OPTION 2

The Contractor must comply with Canadian immigration legislation applicable to foreign nationals entering Canada to work temporarily in fulfillment of the Contract. If the Contractor wishes to hire a foreign national to work in Canada to fulfill the Contract, the Contractor should immediately contact the nearest Canadian Embassy, Consulate or High Commission in the Contractor's country to obtain instructions, information on Citizenship and Immigration Canada's requirements and any required documents. The Contractor is responsible to ensure that foreign nationals have the required information, documents and authorizations before performing any work under the Contract in Canada. The Contractor is responsible for all costs incurred as a result of non-compliance with immigration requirements.

Article 14 Access to Information

Records created by the Contractor under the control of Elections Canada are subject to the *Access to Information Act*. The Contractor acknowledges the responsibilities of Elections Canada under the *Access to Information Act* and must, to the extent possible, assist Elections Canada in discharging these responsibilities. Furthermore, the Contractor acknowledges that section 67.1 of the *Access to Information Act* provides that any person, who destroys, alters, falsifies or conceals a record, or directs anyone to do so, with the intent of obstructing the right of access that is provided by the *Access to Information Act* is guilty of an offence and is liable to imprisonment or a fine, or both.

[Note to Bidders]

If applicable, depending on the legal status of the successful bidder, the following Article will form part of the resulting contract and will be completed at the award of the contract.

Article 15 Joint Venture

ARTICLES OF AGREEMENT

Section 15.01 Joint Venture Contractor

15.01.01 The Contractor confirms that the name of the joint venture is _____ and that it is comprised of the following members:

[Insert at contract award]

(a) With respect to the relationship among members of the joint venture Contractor, each member agrees, represents and warrants (as applicable) that:

- i. _____ has been appointed as the “representative member” of the joint venture Contractor and has full authority to act as agent for each member regarding all matters relating to the Contract;
- ii. by giving notice to the representative member, Elections Canada will be considered to have given notice to all members of the joint venture Contractor; and
- iii. all payments made by Elections Canada to the representative member will act as a release by all the members.

15.01.02 All the members agree that Elections Canada may terminate the Contract at its discretion if there is a dispute among the members that, in Elections Canada’s opinion, affects the performance of the Work in any way.

15.01.03 All the members are jointly and severally liable for the performance of the entire Contract.

15.01.04 The Contractor acknowledges that any change in the membership of the joint venture (i.e., a change in the number of members or the substitution of another legal entity for an existing member) constitutes an assignment and is subject to the assignment provisions of the General Conditions.

15.01.05 The Contractor acknowledges that all security and controlled goods requirements in the Contract, if any, apply to each member of the joint venture Contractor.



Printing of Various Envelopes

GROUP 1

EC50370, EC50380, EC50400, EC50410, EC50420, EC50421 and EC50450

ANNEX A

Specifications



INDEX

PART 1 - EC 50370 (08/2014) Envelope for White Copy of the Statement of the Votes – Page 3

PART 2 - EC 50380 (08/2014) Envelope for yellow copy of the Statement of the Votes – Page 6

PART 3 - EC 50400 (08/2014) Envelope for Daily Ballots Cast – Advance Poll – Page 8

PART 4 - EC50410 (08/2014) - Envelope for Mobile Poll Ballots Cast – Page 11

PART 5 - EC 50420 (08/2014) Envelope for Unused Ballot – Page 14

**PART 6 - EC 50421 (08/2014) Envelope – Record of Votes Cast and Unused Ballots for Advance Poll
Page 17**

PART 7 - EC 50450 (08/2014) Envelope for Ballots Cast – Page 20

PART 8 - Additional Instructions and Shipping Requirements – Page 23

PART 1 - SPECIFICATIONS SHEET – EC50370 (08/2014)

REFERENCE NUMBER AND TITLE: **EC 50370 (08/2014)** Envelope for White Copy of the Statement of the Votes / Enveloppe pour copie blanche du Relevé du scrutin

STYLE: Cross Back Seam

SIZE: 4.5" x 9.5" plus flap – open side

ADHESIVE: On Flap: ½" x 8" glue on flap

PRINTING: Prints black on the front (including flap)
FSC logo prints in black at the back (logo supplied by printer)
No bleed

On Flap: Official Seal and line print in black on the flap

INK: Black

STOCK: White wove 24 lb. or equivalent
Must be FSC stock

IMAGE:

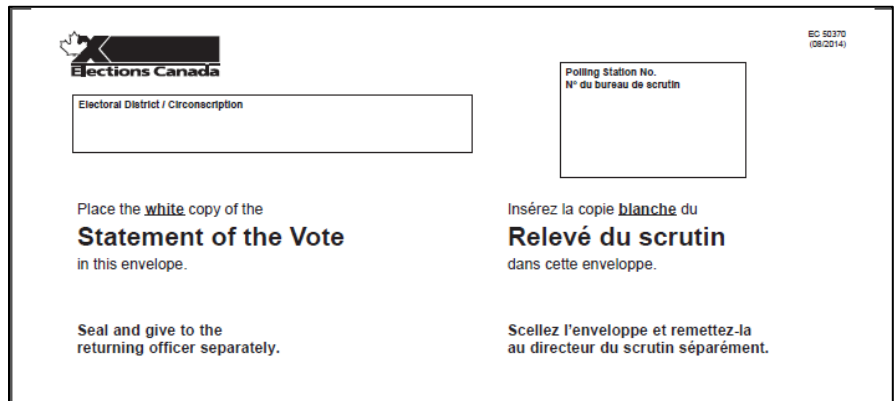

COMPONENT: PDF supplied.
Sample envelope is available upon request.

PROOF: One proof is required for approval before production. Please send to Elections Canada, FREM Directorate, 30 Victoria Street, 10th Floor, Gatineau QC K1A 0M6. Attention: SMS Team

QUANTITY: 120,000 envelopes

OVER:

No over / No under

Items received by Elections Canada in excess of the allowable overage as stipulated in this specification are not to be invoiced. It is the supplier's responsibility to ensure that items are not shipped in excess of the allowable overage

ADDITIONAL QUANTITY (OPTION):

Elections Canada may require additional quantity within the period of the resulting contract. Specifications will remain unchanged.

The supplier will grant to Elections Canada the irrevocable option to acquire the additional quantity at the prices stated in the resulting contract. The option may only be exercised by the Contracting Authority and will be evidenced, for administrative purposes only, through a contract amendment.

Within the quotation, in addition to the cost for the initial quantity, please provide:

- A separate unit cost for up to 50% of the original quantity for each item.
- A separate unit cost for up to 100% of the original quantity for each item.
- Elections Canada makes no guarantee that this option will be exercised during the period of the contract.

PACKAGING:

In corrugated boxes of 500. Each box not to weigh more than 35 lbs. Clearly identify each box as to content in a minimum 20 pt type size.

Label on Boxes:

EC 50370 (08/2014)
*Envelope for White Copy of the
Statement of the Votes /
Enveloppe pour copie blanche
du Relevé du scrutin
Qty/Qté – 500*

NOTE: Labeling of items going to the Distribution Centre must be exactly as indicated. If not, they will not be accepted.

QUOTE SUBMISSION:

Your quotation must show cost per unit and must include the transportation fee.

|

MANDATORY DELIVERY DATE:

October 27, 2014 or sooner

PART 2 - SPECIFICATIONS SHEET – EC50380 (08/2014)

REFERENCE NUMBER AND TITLE: EC 50380 (08/2014) Envelope for yellow copy of the Statement of the Votes / Enveloppe pour copie jaune du Relevé du scrutin

STYLE: Cross Back Seam

SIZE: 4.5" x 9.5" plus flap – open side

ADHESIVE: On Flap: ½" x 8" glue on flap

PRINTING: Prints black on the front (including flap)
FSC logo prints in black at the back (logo supplied by printer)
No bleed

On Flap: Official Seal and line print in black on the flap

INK: Black

STOCK: Rockland 24 lb. Canary (Yellow) or equivalent
Must be FSC

IMAGE:



COMPONENT: PDF supplied.
Sample envelope is available upon request.

PROOF: One proof is required for approval before production. Please send to Elections Canada, FREM Directorate, 30 Victoria Street, 10th Floor, Gatineau QC K1A 0M6. Attention: SMS Team

QUANTITY: 120,000 envelopes

OVER: **No over / No under**
Items received by Elections Canada in excess of the allowable overage as stipulated in this specification are not to be invoiced. It is the supplier's responsibility to ensure that items are not shipped in excess of the allowable overage

ADDITIONAL QUANTITY (OPTION): Elections Canada may require additional quantity within the period of the resulting contract. Specifications will remain unchanged.

The supplier will grant to Elections Canada the irrevocable option to acquire the additional quantity at the prices stated in the resulting contract. The option may only be exercised by the Contracting Authority and will be evidenced, for administrative purposes only, through a contract amendment.

Within the quotation, in addition to the cost for the initial quantity, please provide:

- A separate unit cost for up to 50% of the original quantity for each item.
- A separate unit cost for up to 100% of the original quantity for each item.
- Elections Canada makes no guarantee that this option will be exercised during the period of the contract.

PACKAGING:

In corrugated boxes of 500. Each box not to weigh more than 35 lbs. Clearly identify each box as to content in a minimum 20 pt type size.

Label on Boxes:

EC 50380 (08/2014)
*Envelope for Yellow Copy of the
Statement of the Votes /
Enveloppe pour copie jaune du
Relevé du scrutin
Qty/Qté – 500*

NOTE: Labeling of items going to the Distribution Centre must be exactly as indicated. If not, they will not be accepted.

QUOTE SUBMISSION:

Your quotation must show cost per unit and must include the transportation fee.

MANDATORY DELIVERY DATE: October 27, 2014 or sooner

PART 3 - SPECIFICATIONS SHEET – EC50400 (08/2014)

REFERENCE NUMBER AND TITLE EC 50400 (08/2014) Envelope for Daily Ballots Cast – Advance Poll / Enveloppe pour les bulletins émis au bureau de vote par anticipation chaque jour

STYLE: Centre Seam

SIZE: 9.25" wide x 12.75" long plus 3.75" flap – open end

GUSSET: 3" gussets expansion all around

ADHESIVE: On Flap: 1.5" x 8.25" glue on flap

PRINTING: Prints black on the front (including flap)
FSC logo prints in black in the back (logo supplied by printer)
No bleed

On Flap: Official Seal and line print in black on the flap

INK: Black

STOCK: Natural Kraft, 32 lb., from recycled paper or equivalent
Must be FSC stock

IMAGE:

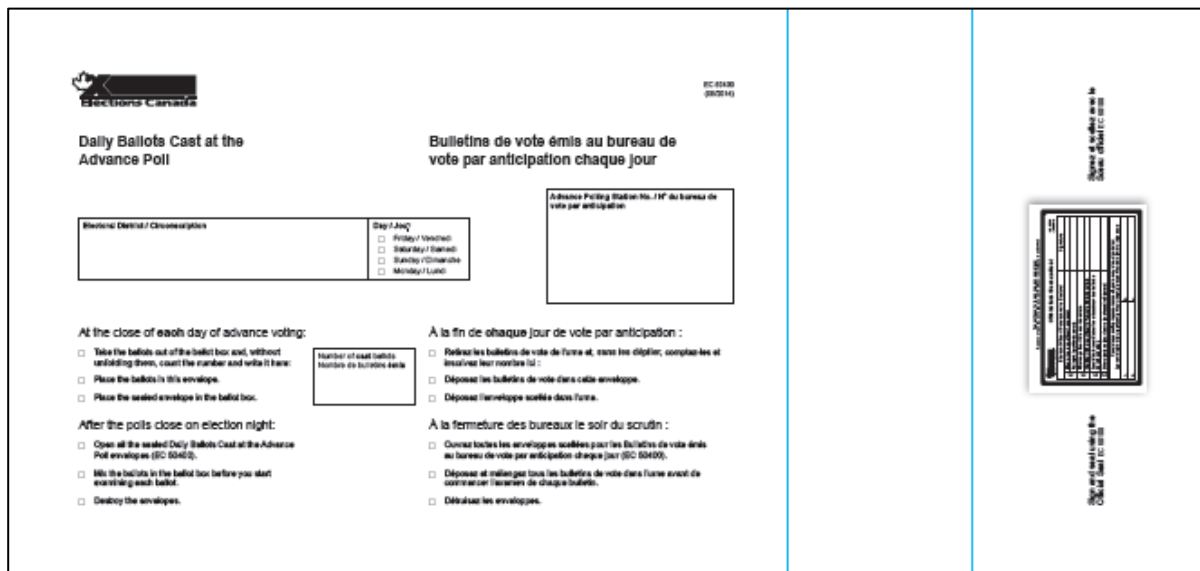

COMPONENT: PDF supplied.
Sample envelope is available upon request.

PROOF: One proof is required for approval before production. Please send to Elections Canada, FREM Directorate, 30 Victoria Street, 10th Floor, Gatineau QC K1A 0M6. Attention: SMS Team

QUANTITY: 12,000 sets of 4 envelopes (48,000 envelopes)

BINDERY Stapled in 4's
Staple to be affixed on the upper left hand corner.

OVER: ***No over / No under***
Items received by Elections Canada in excess of the allowable overage as stipulated in this specification are not to be invoiced. It is the supplier's responsibility to ensure that items are not shipped in excess of the allowable overage

ADDITIONAL QUANTITY (OPTION): Elections Canada may require additional quantity within the period of the resulting contract. Specifications will remain unchanged.

The supplier will grant to Elections Canada the irrevocable option to acquire the additional quantity at the prices stated in the resulting contract. The option may only be exercised by the Contracting Authority and will be evidenced, for administrative purposes only, through a contract amendment.

Within the quotation, in addition to the cost for the initial quantity, please provide:

- A separate unit cost for up to 50% of the original quantity for each item.
- A separate unit cost for up to 100% of the original quantity for each item.
- Elections Canada makes no guarantee that this option will be exercised during the period of the contract.

PACKAGING:

In corrugated boxes. Each box not to weigh more than 35 lbs. Clearly identify each box as to content in a minimum 20 pt type size.

Label on Boxes:

<p><i>EC 50400 (08/2014)</i> <i>Envelope for Daily Ballots Cast – Advance Poll / Enveloppe pour bulletins émis – BVA</i> <i>Qty/Qté – XXX Sets of 4</i></p>
--

NOTE: Labeling of items going to the Distribution Centre must be exactly as indicated. If not, they will not be accepted.

QUOTE SUBMISSION:

Your quotation must show cost per unit and must include the transportation fee.

MANDATORY DELIVERY DATE:

October 27, 2014 or sooner

PART 4 - SPECIFICATIONS SHEET – EC50410 (08/2014)

REFERENCE NUMBER AND TITLE EC50410 (08/2014) - Envelope for Mobile Poll Ballots Cast / Enveloppe pour bulletins de vote recueillis - bureau itinérant

STYLE: Centre Seam

SIZE: 9.25" wide x 12.75" long plus 3.75" flap – open end

GUSSET: 3" gussets expansion all around

ADHESIVE: On Flap: 1.5" x 8.25" glue on flap

PRINTING: Prints black on the front (including flap)
 FSC logo prints in black at the back (logo supplied by printer)
 No bleed

On Flap: Official Seal and line print in black on the flap

INK: Black

STOCK: Natural Kraft, 32 lb., from recycled paper or equivalent
 Must be FSC stock

IMAGE:

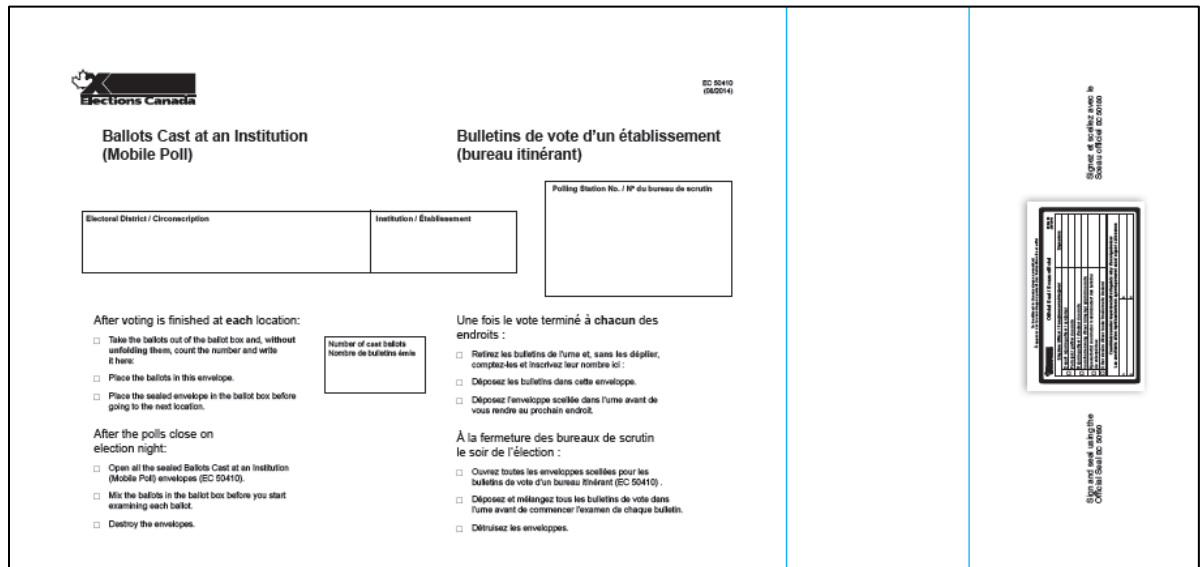

COMPONENT: PDF supplied.
 Sample envelope is available upon request.

PROOF: One proof is required for approval before production. Please send to Elections Canada, FREM Directorate, 30 Victoria Street, 10th Floor, Gatineau QC K1A 0M6. Attention: SMS Team

QUANTITY: 5,000 sets of 4 envelopes (20,000 envelopes)

BINDERY

Stapled in 4's
Staple to be affixed on the upper left hand corner.

OVER:

No over / No under

Items received by Elections Canada in excess of the allowable overage as stipulated in this specification are not to be invoiced. It is the supplier's responsibility to ensure that items are not shipped in excess of the allowable overage

ADDITIONAL QUANTITY (OPTION):

Elections Canada may require additional quantity within the period of the resulting contract. Specifications will remain unchanged.

The supplier will grant to Elections Canada the irrevocable option to acquire the additional quantity at the prices stated in the resulting contract. The option may only be exercised by the Contracting Authority and will be evidenced, for administrative purposes only, through a contract amendment.

Within the quotation, in addition to the cost for the initial quantity, please provide:

- A separate unit cost for up to 50% of the original quantity for each item.
- A separate unit cost for up to 100% of the original quantity for each item.
- Elections Canada makes no guarantee that this option will be exercised during the period of the contract.

PACKAGING:

In corrugated boxes. Each box not to weigh more than 35 lbs. Clearly identify each box as to content in a minimum 20 pt type size.

Label on Boxes:

For Sets of 4's:

<p><i>EC 50410 (08/2014)</i> <i>Envelope for Ballots Cast – Mobile Poll / Enveloppe pour bulletins de vote recueillis – Bureau itinérant</i> <i>Qty/Qté – XXX Sets of 4</i></p>
--

NOTE: Labeling of items going to the Distribution Centre must be exactly as indicated. If not, they will not be accepted.

QUOTE SUBMISSION:

Your quotation must show cost per unit and must include the transportation fee.

MANDATORY DELIVERY DATE:

October 27, 2014 or sooner

PART 5 - SPECIFICATIONS SHEET – EC50420 (08/2014)

REFERENCE NUMBER AND TITLE EC 50420 (08/2014) Envelope for Unused Ballot / Enveloppe pour les bulletins de vote inutilisés

STYLE: Centre Seam

SIZE: 9.25" wide x 12.75" long plus 3.75" flap – open end

GUSSET: 3" gussets expansion all around

ADHESIVE: On Flap: 1.5" x 8.25" glue on flap

PRINTING: Prints black on the front (including flap)
FSC logo prints in black at the back (logo supplied by printer)
No bleed

On Flap: Official Seal and line print in black on the flap

INK: Black

STOCK: Natural Kraft, 32 lb, from recycled paper or equivalent
Must be FSC stock

IMAGE:

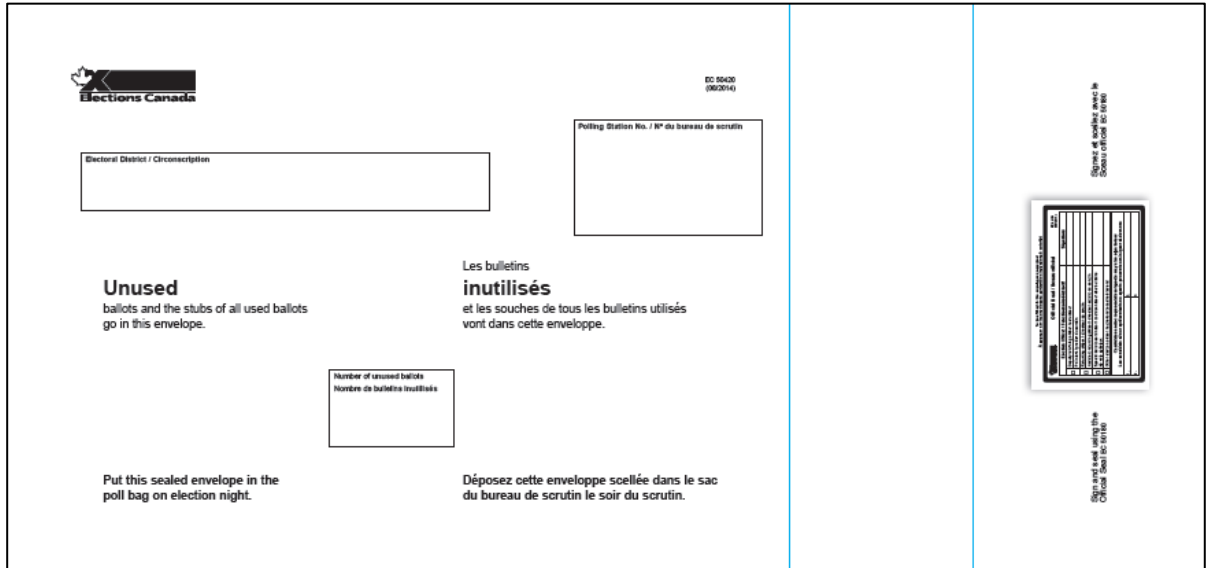

COMPONENT: PDF supplied.
Sample is similar envelope is available upon request.

PROOF: One proof is required for approval before production. Please send to Elections Canada, FREM Directorate, 30 Victoria Street, 10th Floor, Gatineau QC K1A 0M6. Attention: SMS Team

QUANTITY: a) 5,500 sets of 4 envelopes (22,000 envelopes)
b) 110,000 single
Total of 132,000 envelopes

BINDERY: a) 22,000 envelopes stapled in 4's – staple to be affixed on the upper left hand corner (5,500 sets)
b) 110,000 envelopes – bulk in corrugated boxes

OVER: ***No over / No under***
Items received by Elections Canada in excess of the allowable overage as stipulated in this specification are not to be invoiced. It is the supplier's responsibility to ensure that items are not shipped in excess of the allowable overage

ADDITIONAL QUANTITY (OPTION): Elections Canada may require additional quantity within the period of the resulting contract. Specifications will remain unchanged.

The supplier will grant to Elections Canada the irrevocable option to acquire the additional quantity at the prices stated in the resulting contract. The option may only be exercised by the Contracting Authority and will be evidenced, for administrative purposes only, through a contract amendment.

Within the quotation, in addition to the cost for the initial quantity, please provide:

- A separate unit cost for up to 50% of the original quantity for each item.
- A separate unit cost for up to 100% of the original quantity for each item.
- Elections Canada makes no guarantee that this option will be exercised during the period of the contract.

PACKAGING:

In corrugated boxes. Each box not to weigh more than 35 lbs. Clearly identify each box as to content in a minimum 20 pt type size.

Label on Boxes:

For sets of 4:

EC 50420 (08/2014)
*Envelope for Unused Ballot /
Enveloppe pour bulletins de
vote inutilisés*
Qty/Qté – XXX Sets of 4

For singles:

EC 50420 (08/2014)
*Envelope for Unused Ballot /
Enveloppe pour bulletins de
vote inutilisés*
Qty/Qté – XXX Envelopes

NOTE: Labeling of items going to the Distribution Centre must be exactly as indicated. If not, they will not be accepted.

**DO NOT MIX THE DIFFERENT PACKAGING
IN SAME SHIPPING BOX.**

QUOTE SUBMISSION:

Your quotation must show cost per unit and must include the transportation fee.

MANDATORY DELIVERY DATE:

October 27, 2014 or sooner

PART 6 - SPECIFICATIONS SHEET – EC50421 (08/2014)

REFERENCE NUMBER AND TITLE EC 50421 (08/2014) Envelope – Record Of Votes Cast and Unused Ballots for Advance Poll / Enveloppe pour Registre du vote du BVA et bulletins inutilisés

STYLE: Centre Seam

SIZE: 9.25" wide x 12.75" long plus 3.75" flap – open end

GUSSET: 3" gussets expansion all around

ADHESIVE: On Flap: 1.5" x 8.25" glue on flap

PRINTING: Prints black on the front (including flap)
 FSC logo prints in black at the back (logo supplied by printer)
 No bleed

On Flap: Official Seal and line print in black on the flap

INK: Black

STOCK: Natural Kraft, 32 lb, from recycled paper or equivalent
 Must be FSC stock

IMAGE:

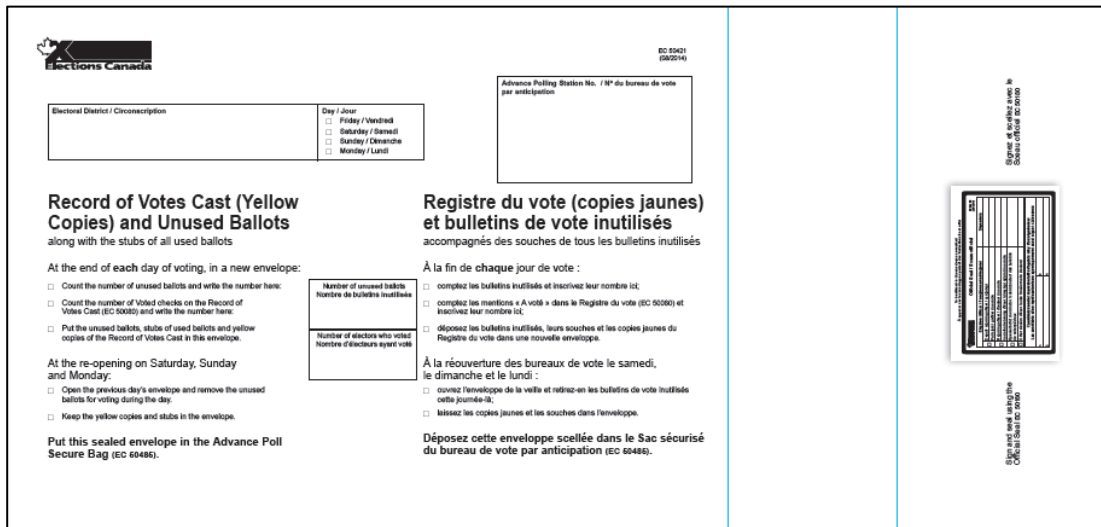

COMPONENT: PDF supplied.
 Sample of similar envelope is available upon request.

PROOF: One proof is required for approval before production. Please send to Elections Canada, FREM Directorate, 30 Victoria Street, 10th Floor, Gatineau QC K1A 0M6. Attention: SMS Team

QUANTITY: 12,000 sets of 4 envelopes (48,000 envelopes)

BINDERY: Stapled in 4's
Staple to be affixed on the upper left hand corner (12,000 sets)

OVER: ***No over / No under***
Items received by Elections Canada in excess of the allowable overage as stipulated in this specification are not to be invoiced. It is the supplier's responsibility to ensure that items are not shipped in excess of the allowable overage

ADDITIONAL QUANTITY (OPTION): Elections Canada may require additional quantity within the period of the resulting contract. Specifications will remain unchanged.

The supplier will grant to Elections Canada the irrevocable option to acquire the additional quantity at the prices stated in the resulting contract. The option may only be exercised by the Contracting Authority and will be evidenced, for administrative purposes only, through a contract amendment.

Within the quotation, in addition to the cost for the initial quantity, please provide:

- A separate unit cost for up to 50% of the original quantity for each item.
- A separate unit cost for up to 100% of the original quantity for each item.
- Elections Canada makes no guarantee that this option will be exercised during the period of the contract.

PACKAGING:

In corrugated boxes. Each box not to weigh more than 35 lbs. Clearly identify each box as to content in a minimum 20 pt type size.

Label on Boxes:

EC 50421 (08/2014)
*Envelope for Record Of Votes
Cast-Unused Ballots ADV /
Enveloppe pour Registre du vote
du BVA et bulletins inutilisés
Qty/Qté – XXX sets of 4*

NOTE: Labeling of items going to the Distribution Centre must be exactly as indicated. If not, they will not be accepted.

QUOTE SUBMISSION:

Your quotation must show cost per unit and must include the transportation fee.

MANDATORY DELIVERY DATE:

October 27, 2014 or sooner

PART 7 - SPECIFICATIONS SHEET – EC50450 (08/2014)

REFERENCE NUMBER AND TITLE: EC 50450 (08/2014) Envelope for Ballots Cast / Enveloppe pour les bulletins émis

STYLE: Centre Seam

SIZE: 9.25" wide x 12.75" long plus 3.75" flap – open end

GUSSET: 3" gussets expansion all around

ADHESIVE: On Flap: 1.5" x 8.25" glue on flap

PRINTING: Prints black on the front (including flap)
FSC logo prints in black at the back (logo supplied by printer)
No bleed

On Flap: Official Seal and line print in black on the flap

INK: Black

STOCK: Natural Kraft, 32 lb, from recycled paper or equivalent
Must be FSC stock

IMAGE:

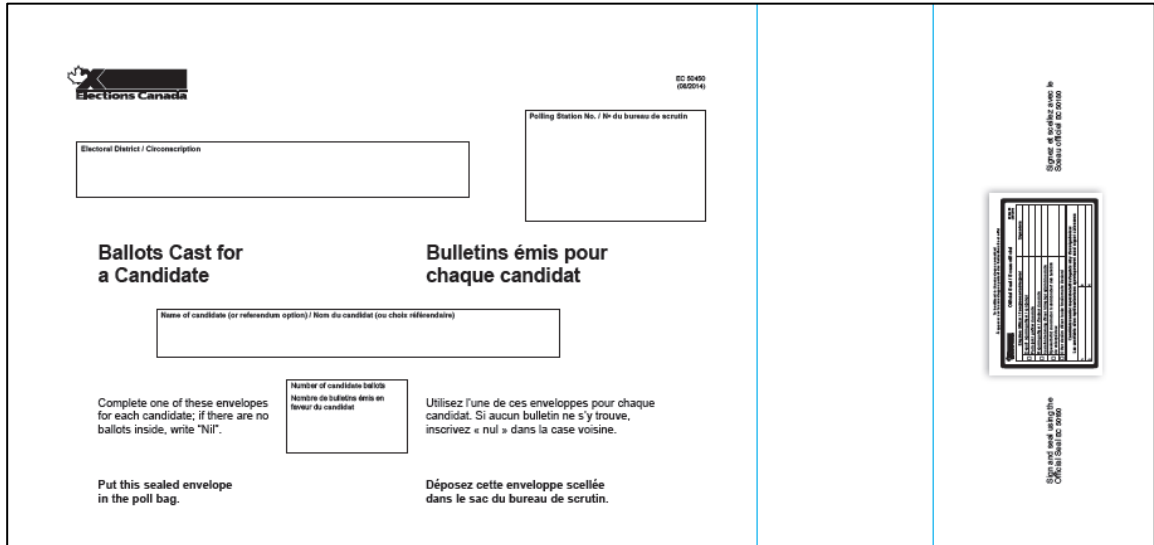

COMPONENT: PDF supplied.

PROOF: Sample of similar envelope is available upon request.
One proof is required for approval before production. Please send to Elections Canada, FREM Directorate, 30 Victoria Street, 10th Floor, Gatineau QC K1A 0M6. Attention: SMS Team

QUANTITY : 130,000 sets of 7 (910,000 envelopes)

BINDERY : Stapled in 7's – Staple to be affixed on the upper left hand

corner

OVER :

No over / No under

Items received by Elections Canada in excess of the allowable overage as stipulated in this specification are not to be invoiced. It is the supplier's responsibility to ensure that items are not shipped in excess of the allowable overage

ADDITIONAL QUANTITY (OPTION): Elections Canada may require additional quantity within the period of the resulting contract. Specifications will remain unchanged.

The supplier will grant to Elections Canada the irrevocable option to acquire the additional quantity at the prices stated in the resulting contract. The option may only be exercised by the Contracting Authority and will be evidenced, for administrative purposes only, through a contract amendment.

Within the quotation, in addition to the cost for the initial quantity, please provide:

- A separate unit cost for up to 50% of the original quantity for each item.
- A separate unit cost for up to 100% of the original quantity for each item.
- Elections Canada makes no guarantee that this option will be exercised during the period of the contract.

PACKAGING:

In corrugated boxes. Each box not to weigh more than 35 lbs. Clearly identify each box as to content in a minimum 20 pt type size.

Label on Boxes:

<p><i>EC 50450 (08/2014)</i> <i>Envelope for Ballots Cast /</i> <i>Enveloppe pour bulletins émis</i> <i>Qty/Qté – XXX Sets of 7</i></p>
--

NOTE: Labeling of items going to the Distribution Centre must be exactly as indicated. If not, they will not be accepted.

QUOTE SUBMISSION:

Your quotation must show cost per unit and must include the transportation fee.

MANDATORY DELIVERY DATE:

October 27, 2014 or sooner

PART 8 - ADDITIONAL INSTRUCTIONS AND SHIPPING REQUIREMENTS

SHIPPING INSTRUCTIONS: Ship on non-returnable shipping skids 48" wide by 42" deep not to exceed 54" high stacking height. The material must be accessible by hand held hydraulic pallet movers.

SKIDS: Brewery type skid – 4 way entry type, 48" wide by 42" deep, 3 stringers with three blocks, each running 48" long

NOTE: Items shipped to the Distribution Centre not on requested skids will not be accepted upon delivery.

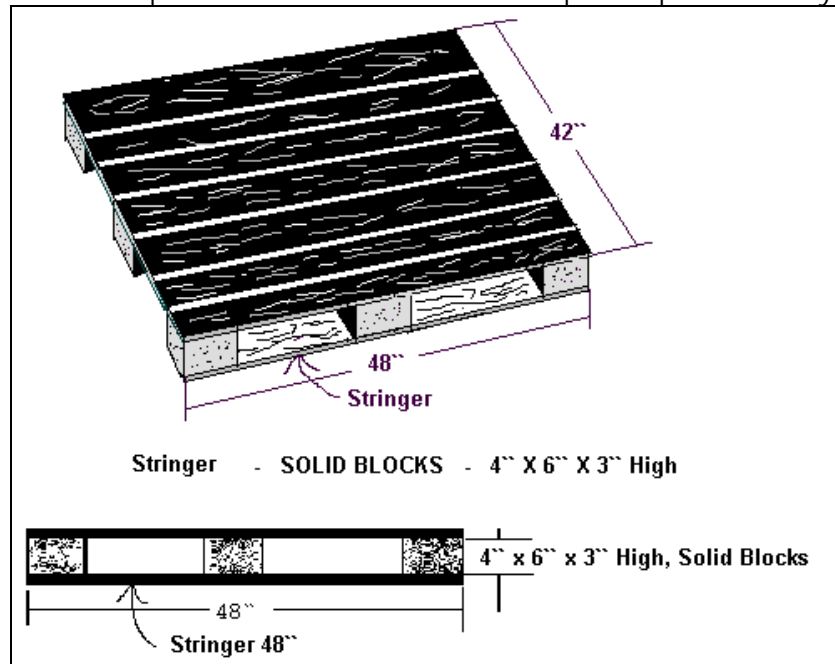

HOURS OF OPERATION : 8 a.m. to 12:00 noon / 1:00 p.m. to 4:00 p.m.

DESTINATION: Elections Canada Distribution Centre
100-440 Coventry Road, Ottawa, Ontario K1K 2Y5

INVOICE Please send your invoice to the following address:
Jocelyne Leroux
SMS Team
Elections Canada
30 Victoria Street, Room 10-A-005
Gatineau, Quebec K1A 0M6

It is the responsibility of the supplier to provide a valid tax registration number for: HST, GST and QST, as applicable. Elections Canada will not validate tax registration numbers. If applicable taxes are invoiced without a tax registration number(s), Elections Canada will not pay the applicable tax(es).

ADDITIONAL INFORMATION:

Invoices must indicate the Purchase Order number, if applicable, the Reference Number, the revision date and show any correction cost breakdown whenever it is applicable. No change in these specifications will be accepted unless approved by the project authority.

Elections Canada must be informed of the cost of any author's alterations as soon as possible. A contract amendment must be made as soon as any changes affecting cost occur.

The printer is to return to Elections Canada a final electronic file properly identified with all or any corrections made at the proofing stage before invoices are approved for payment.

Wrapping and shipping instructions must be followed to the letter or the Distribution Centre may refuse to accept the shipment.



Printing of Various Envelopes

GROUP 2

EC50385, EC50390, EC50422, EC50423, EC50430, EC50431, EC50440 and EC50460

ANNEX A

Specifications



INDEX

PART 1 - EC 50385 (08/2014) Envelope for EC 50111– Page 3

PART 2 - EC 50390 (08/2014) Registration and/or Correction Certificates Envelope – Page 6

PART 3 - EC 50422 (08/2014) Oath of Residence Envelope– Page 9

PART 4 - EC 50423 (08/2014) Candidates’ Rep Authorization/Sign-in Envelope – Page 12

PART 5 - EC 50430 (08/2014) Envelope for Spoiled Ballot Papers – Page 15

PART 6 - EC 50431 (08/2014) Envelope for Spoiled ballot paper – Advance Poll - Page 18

PART 7 - EC 50440 (08/2014) Envelope for Rejected Ballots – Page 21

PART 8 - EC 50460 (08/2014) Document Envelope Cast – Page 24

PART 9 - Additional Instructions and Shipping Requirements – Page 27

PART 1 - SPECIFICATIONS SHEET – EC50385 (08/2014)

REFERENCE NUMBER AND TITLE EC 50385 (08/2014) Envelope for EC 50111 / Enveloppe pour EC 50111

STYLE: Centre Seam

SIZE: 9.5" wide x 14.5" long plus 3.25" flap – open end

GUSSET: 2" gussets expansion all around

ADHESIVE: 1.25" x 8.75" glue on flap

PRINTING: Prints black on the front (including flap)
FSC logo prints in black at the back (logo supplied by printer)
No bleed

On Flap: Official Seal and line print in black on the flap

INK: Black

STOCK: White Wove, 32 lb or equivalent
Must be FSC stock

IMAGE:

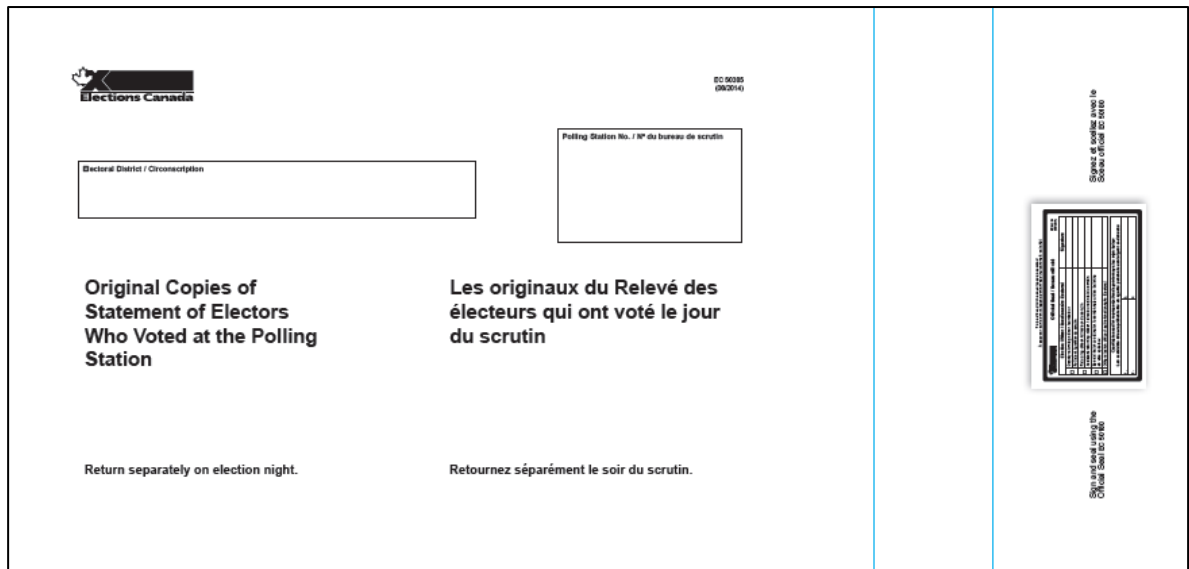

COMPONENT: PDF supplied.
Sample envelope is available upon request.

PROOF: One proof is required for approval before production. Please send to Elections Canada, FREM Directorate, 30 Victoria Street, 10th Floor, Gatineau QC K1A 0M6. Attention: SMS Team

QUANTITY: 116,000 envelopes

OVER: *No over / No under*

Items received by Elections Canada in excess of the allowable overage as stipulated in this specification are not to be invoiced. It is the supplier's responsibility to ensure that items are not shipped in excess of the allowable overage

ADDITIONAL QUANTITY (OPTION): Elections Canada may require additional quantity within the period of the resulting contract. Specifications will remain unchanged.

The supplier will grant to Elections Canada the irrevocable option to acquire the additional quantity at the prices stated in the resulting contract. The option may only be exercised by the Contracting Authority and will be evidenced, for administrative purposes only, through a contract amendment.

Within the quotation, in addition to the cost for the initial quantity, please provide:

- A separate unit cost for up to 50% of the original quantity for each item.
- A separate unit cost for up to 100% of the original quantity for each item.
- Elections Canada makes no guarantee that this option will be exercised during the period of the contract.

PACKAGING: In corrugated boxes. Each box not to weigh more than 35 lbs. Clearly identify each box as to content in a minimum 20 pt type size.

Label on Boxes:

<p><i>EC 50385 (08/2014)</i> <i>Envelope for EC 50111 /</i> <i>Enveloppe pour EC 50111</i> <i>Qty/Qté – XXX</i></p>
--

NOTE: Labeling of items going to the Distribution Centre must be exactly as indicated. If not, they will not be accepted.

QUOTE SUBMISSION:

Your quotation must show cost per unit and must include the transportation fee.

MANDATORY DELIVERY DATE:

October 27, 2014 or sooner

PART 2 - SPECIFICATIONS SHEET – EC50390 (08/2014)

REFERENCE NUMBER AND TITLE EC 50390 (08/2014) Registration and/or Correction Certificates Envelope / Enveloppe pour certificats d'inscription et/ou de correction

STYLE: Centre Seam

SIZE: 9.5" wide x 14" long plus 3.25" flap – open end

GUSSET: 2" gussets expansion all around

ADHESIVE: 1.25" x 8.75" glue on flap

PRINTING: Prints black on the front (including flap)
 FSC logo prints in black at the back (logo supplied by printer)
 No bleed

On Flap: Official Seal and line print in black on the flap

INK: Black

STOCK: White Wove, 32 lb or equivalent
 Must be FSC stock

IMAGE:

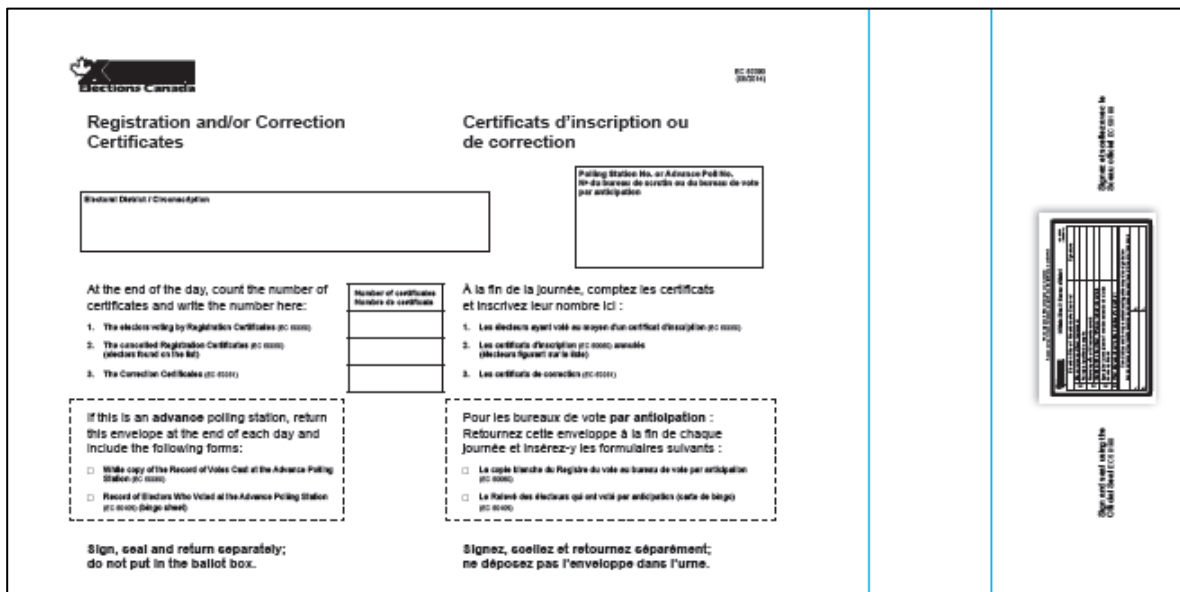

COMPONENT: PDF supplied.
 Sample envelope is available upon request.

PROOF: One proof is required for approval before production. Please send to Elections Canada, FREM Directorate, 30 Victoria Street, 10th Floor, Gatineau QC K1A 0M6. Attention: SMS Team

QUANTITY:

- a) 22,000 sets of 4 envelopes (88,000 envelopes)
- b) 140,000 envelopes

Total of 228,000 envelopes

BINDERY:

- a) 88,000 envelopes stapled in 4's – staple to be affixed on the upper left hand corner (22,000 sets)
- b) 140,000 envelopes – bulk in corrugated boxes

OVER:

No over / No under

Items received by Elections Canada in excess of the allowable overage as stipulated in this specification are not to be invoiced. It is the supplier's responsibility to ensure that items are not shipped in excess of the allowable overage.

ADDITIONAL QUANTITY (OPTION):

Elections Canada may require additional quantity within the period of the resulting contract. Specifications will remain unchanged.

The supplier will grant to Elections Canada the irrevocable option to acquire the additional quantity at the prices stated in the resulting contract. The option may only be exercised by the Contracting Authority and will be evidenced, for administrative purposes only, through a contract amendment.

Within the quotation, in addition to the cost for the initial quantity, please provide:

- A separate unit cost for up to 50% of the original quantity for each item.
- A separate unit cost for up to 100% of the original quantity for each item.
- Elections Canada makes no guarantee that this option will be exercised during the period of the contract.

PACKAGING:

In corrugated boxes. Each box not to weigh more than 35 lbs. Clearly identify each box as to content in a minimum 20 pt type size.

Label on Boxes:

For sets of 4:

EC 50390 (08/2014)
*Registration and/or Correction
Certificates Envelope /
Enveloppe pour certificats
d'inscription et/ou de correction
Qty/Qté – XXX Sets of 4*

For singles:

EC 50390 (08/2014)
*Registration and/or Correction
Certificates Envelope /
Enveloppe pour certificats
d'inscription et/ou de correction
Qty/Qté – XXX Envelopes*

NOTE: Labeling of items going to the Distribution Centre must be exactly as indicated. If not, they will not be accepted.

**DO NOT MIX THE DIFFERENT PACKAGING
IN SAME SHIPPING BOX.**

QUOTE SUBMISSION:

Your quotation must show cost per unit and must include the transportation fee.

MANDATORY DELIVERY DATE:

October 27, 2014 or sooner

PART 3 - SPECIFICATIONS SHEET – EC50422 (08/2014)

REFERENCE NUMBER AND TITLE EC 50422 (08/2014) Oath of Residence Envelope / Enveloppe pour serment de résidence

STYLE: Centre Seam

SIZE: 9.5" wide x 14" long plus 3.25" flap – open end

GUSSET: 2" gussets expansion all around

ADHESIVE: 1.25" x 8.75" glue on flap

PRINTING: Prints black on the front (including flap)
FSC logo prints in black at the back (logo supplied by printer)
No bleed

On Flap: Official Seal and line print in black on the flap

INK: Black

STOCK: White Wove 32 lb or equivalent
Must be FSC stock

IMAGE:

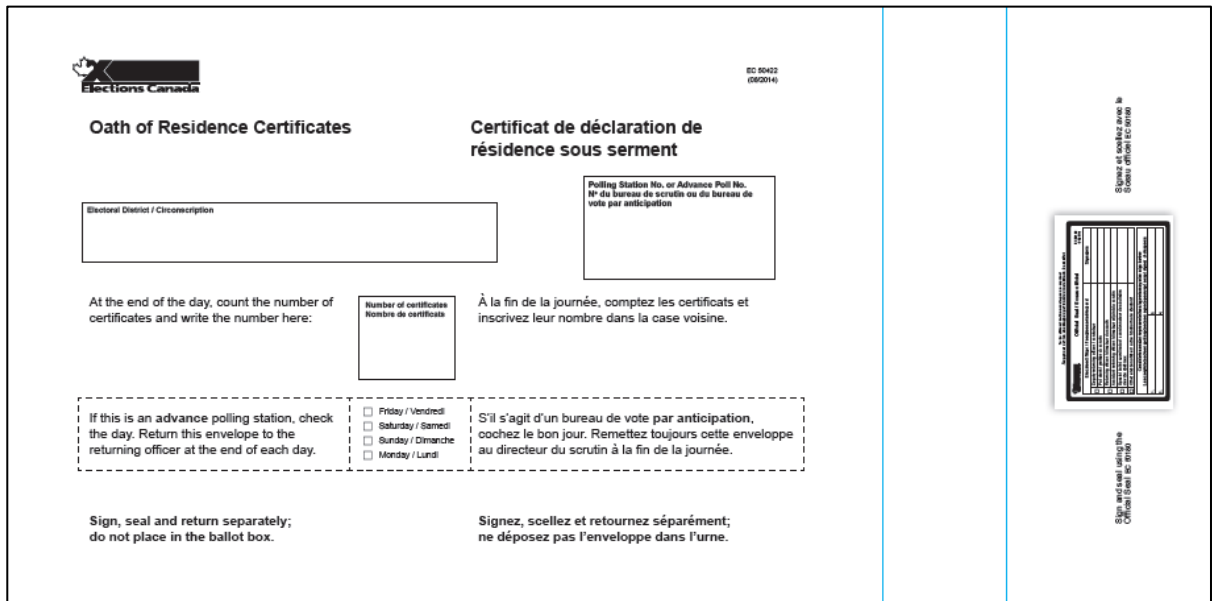

COMPONENT: PDF supplied.
Sample of similar envelope is available upon request.

PROOF: One proof is required for approval before production. Please send to Elections Canada, FREM Directorate, 30 Victoria Street, 10th Floor, Gatineau QC K1A 0M6. Attention: SMS Team

QUANTITY: a) 11,000 sets of 4 envelopes (44,000 envelopes)
b) 113,000 envelopes
Total of 157,000 envelopes

BINDERY: a) 44,000 envelopes stapled in 4's – staple to be affixed on the upper left hand corner (11,000 sets)
b) 113,000 envelopes – bulk in corrugated boxes

OVER: ***No over / No under***
Items received by Elections Canada in excess of the allowable overage as stipulated in this specification are not to be invoiced. It is the supplier's responsibility to ensure that items are not shipped in excess of the allowable overage

ADDITIONAL QUANTITY (OPTION): Elections Canada may require additional quantity within the period of the resulting contract. Specifications will remain unchanged.

The supplier will grant to Elections Canada the irrevocable option to acquire the additional quantity at the prices stated in the resulting contract. The option may only be exercised by the Contracting Authority and will be evidenced, for administrative purposes only, through a contract amendment.

Within the quotation, in addition to the cost for the initial quantity, please provide:

- A separate unit cost for up to 50% of the original quantity for each item.
- A separate unit cost for up to 100% of the original quantity for each item.
- Elections Canada makes no guarantee that this option will be exercised during the period of the contract.

PACKAGING:

In corrugated boxes. Each box not to weigh more than 35 lbs. Clearly identify each box as to content in a minimum 20 pt type size.

Label on Boxes:

For sets of 4:

EC 50422 (08/2014)
*Oath of Residence Envelope /
Enveloppe pour serment de
résidence*
Qty/Qté – XXX Sets of 4

For singles:

EC 50390 (08/2014)
*Oath of Residence Envelope /
Enveloppe pour serment de
résidence*
Qty/Qté – XXX Envelopes

NOTE: Labeling of items going to the Distribution Centre must be exactly as indicated. If not, they will not be accepted.

**DO NOT MIX THE DIFFERENT PACKAGING
IN SAME SHIPPING BOX.**

QUOTE SUBMISSION:

Your quotation must show cost per unit and must include the transportation fee.

MANDATORY DELIVERY DATE:

October 27, 2014 or sooner

PART 4 - SPECIFICATIONS SHEET – EC50423 (08/2014)

REFERENCE NUMBER AND TITLE EC 50423 (08/2014) Candidates' Rep Authorization/Sign-in Envelope / Enveloppe-Autorisation et inscription des rep des candidats

STYLE: Centre Seam

SIZE: 9.5" wide x 14" long plus 3.25" flap – open end

GUSSET: 2" gussets expansion all around

ADHESIVE: 1.25" x 8.75" glue on flap

PRINTING: Prints black on the front (including flap)
FSC logo prints in black at the back
No bleed

On Flap: Official Seal and line print in black on the flap

INK: Black

STOCK: White Wove, 32 lb or equivalent
Must be FSC stock

STYLE: Centre Seam

IMAGE:

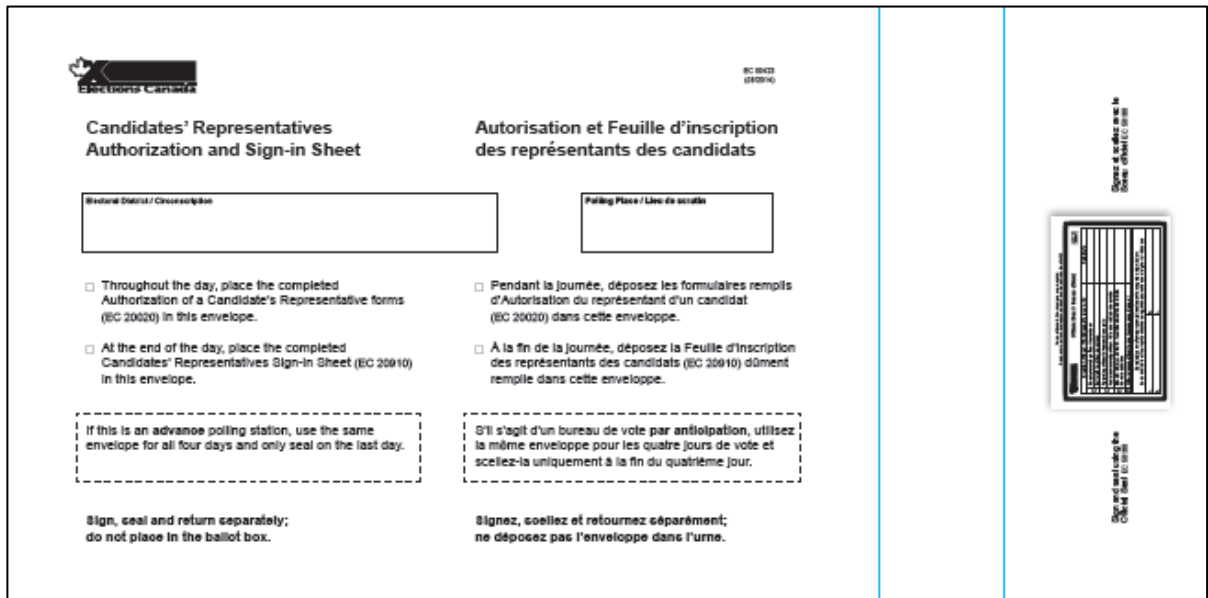

COMPONENT: PDF supplied.
Sample of similar envelope is available upon request.

PROOF: One proof is required for approval before production. Please send to Elections Canada, FREM Directorate, 30 Victoria Street, 10th Floor, Gatineau QC K1A 0M6. Attention: SMS Team

QUANTITY: 49,000 singles

OVER: ***No over / No under***
Items received by Elections Canada in excess of the allowable overage as stipulated in this specification are not to be invoiced. It is the supplier's responsibility to ensure that items are not shipped in excess of the allowable overage

ADDITIONAL QUANTITY (OPTION): Elections Canada may require additional quantity within the period of the resulting contract. Specifications will remain unchanged.

The supplier will grant to Elections Canada the irrevocable option to acquire the additional quantity at the prices stated in the resulting contract. The option may only be exercised by the Contracting Authority and will be evidenced, for administrative purposes only, through a contract amendment.

Within the quotation, in addition to the cost for the initial quantity, please provide:

- A separate unit cost for up to 50% of the original quantity for each item.
- A separate unit cost for up to 100% of the original quantity for each item.
- Elections Canada makes no guarantee that this option will be exercised during the period of the contract.

PACKAGING:

In corrugated boxes. Each box not to weigh more than 35 lbs. Clearly identify each box as to content in a minimum 20 pt type size.

Label on Boxes:

EC 50423 (08/2014)
*Candidate Rep. Authorization
and sign-in sheet Envelope /
Enveloppe-Autorisation et
inscription des rep. des candidats
Qty/Qté -XXX*

NOTE: Labeling of items going to the Distribution Centre must be exactly as indicated. If not, they will not be accepted.

QUOTE SUBMISSION:

Your quotation must show cost per unit and must include the transportation fee.

MANDATORY DELIVERY DATE:

October 27, 2014 or sooner

PART 5 - SPECIFICATIONS SHEET – EC50430 (08/2014)

REFERENCE NUMBER AND TITLE EC 50430 (08/2014) Envelope for Spoiled Ballot Papers / Enveloppe pour les bulletins de vote annulés

STYLE: Centre Seam

SIZE: 6.5" wide x 9.5" long plus 1.5" flap – open end

ADHESIVE: On Flap: 1" x 5" glue on flap

PRINTING: Prints black on the front (including flap)
FSC logo prints in black at the back in back of envelope (logo supplied by printer)
No bleed

On Flap: Official Seal and line print in black on the flap

INK: Black

STOCK: Natural Kraft, 24lb or equivalent
Must be FSC stock

IMAGE:

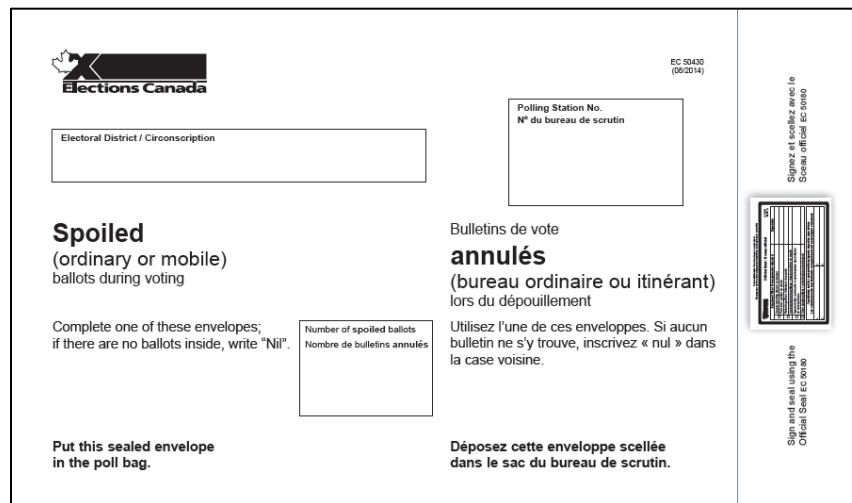

COMPONENT: PDF supplied.
Sample of a similar envelope is available upon request.

PROOF: One proof is required for approval before production. Please send to Elections Canada, FREM Directorate, 30 Victoria Street, 10th Floor, Gatineau QC K1A 0M6. Attention: SMS Team

QUANTITY: a) 5,000 sets of 4 envelopes (20,000 envelopes)
b) 110,000 single
Total of 130,000 envelopes

BINDERY:

- a) 20,000 envelopes stapled in 4's – staple to be affixed on the upper left hand corner (5,000 sets)
- b) 110,000 envelopes – bulk in corrugated boxes

OVER:

No over / No under

Items received by Elections Canada in excess of the allowable overage as stipulated in this specification are not to be invoiced. It is the supplier's responsibility to ensure that items are not shipped in excess of the allowable overage.

ADDITIONAL QUANTITY (OPTION):

Elections Canada may require additional quantity within the period of the resulting contract. Specifications will remain unchanged.

The supplier will grant to Elections Canada the irrevocable option to acquire the additional quantity at the prices stated in the resulting contract. The option may only be exercised by the Contracting Authority and will be evidenced, for administrative purposes only, through a contract amendment.

Within the quotation, in addition to the cost for the initial quantity, please provide:

- A separate unit cost for up to 50% of the original quantity for each item.
- A separate unit cost for up to 100% of the original quantity for each item.
- Elections Canada makes no guarantee that this option will be exercised during the period of the contract.

PACKAGING:

In corrugated boxes. Each box not to weigh more than 35 lbs. Clearly identify each box as to content in a minimum 20 pt type size.

Label on boxes:

For sets of 4:

EC 50430 (08/2014)
*Envelope for Spoiled Ballot
Papers / Enveloppe pour les
bulletins de vote annulés
Qty/Qté – XXX Sets of 4*

For singles:

EC 50430 (08/2014)
*Envelope for Spoiled Ballot
Papers / Enveloppe pour les
bulletins de vote annulés
Qty/Qté – XXX Envelopes*

NOTE: Labeling of items going to the Distribution Centre must be exactly as indicated. If not, they will not be accepted.

**DO NOT MIX THE DIFFERENT PACKAGING
IN SAME SHIPPING BOX.**

QUOTE SUBMISSION:

Your quotation must show cost per set of 4 and per single and must include the transportation fee.

MANDATORY DELIVERY DATE:

October 27, 2014 or sooner

PART 6 - SPECIFICATIONS SHEET – EC50431 (08/2014)

REFERENCE NUMBER AND TITLE: EC 50431 (08/2014) Envelope for Spoiled ballot paper – Advance Poll

STYLE: Centre Seam

SIZE: 6.5" wide x 9.5" long plus 1.5" flap – open end

ADHESIVE: On Flap: 1" x 5" glue on flap

PRINTING: Prints black on the front (including flap)
FSC logo prints in black in the back of envelope (logo supplied by printer)
No bleed

On Flap: Official Seal and line print in black on the flap

INK: Black

STOCK: Natural Kraft, 24lb from recycled paper or equivalent
Must be FSC stock

IMAGE:

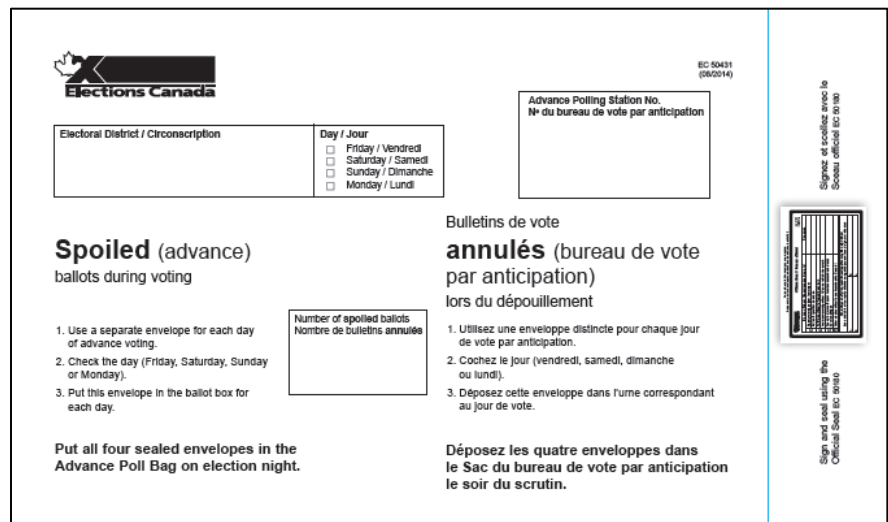

COMPONENT: PDF supplied.
Sample of a similar envelope is available upon request.

PROOF: One proof is required for approval before production. Please send to Elections Canada, FREM Directorate, 30 Victoria Street, 10th Floor, Gatineau QC K1A 0M6 Attention: SMS Team

QUANTITY: 12,000 sets of 4 (48,000 envelopes)

BINDERY: Stapled in 4's, top left hand corner

OVER:

No over / No under

Items received by Elections Canada in excess of the allowable overage as stipulated in this specification are not to be invoiced. It is the supplier's responsibility to ensure that items are not shipped in excess of the allowable overage

ADDITIONAL QUANTITY (OPTION):

Elections Canada may require additional quantity within the period of the resulting contract. Specifications will remain unchanged.

The supplier will grant to Elections Canada the irrevocable option to acquire the additional quantity at the prices stated in the resulting contract. The option may only be exercised by the Contracting Authority and will be evidenced, for administrative purposes only, through a contract amendment.

Within the quotation, in addition to the cost for the initial quantity, please provide:

- A separate unit cost for up to 50% of the original quantity for each item.
- A separate unit cost for up to 100% of the original quantity for each item.
- Elections Canada makes no guarantee that this option will be exercised during the period of the contract.

PACKAGING:

In corrugated boxes. Each box not to weigh more than 35 lbs. Clearly identify each box as to content in a minimum 20 pt type size.

Label on Boxes:

EC 50431 (08/2014)
*Envelope for Spoiled Ballot
Papers – Advance Poll /
Enveloppe pour les bulletins de
vote annulés – Bureau de vote
par anticipation
Qty/Qté – XXX Sets of 4*

NOTE: Labeling of items going to the Distribution Centre must be exactly as indicated. If not, they will not be accepted.

QUOTE SUBMISSION: Your quotation must show cost per set of 4 and must include the transportation fee.

MANDATORY DELIVERY DATE: October 27, 2014 or sooner

PART 7 - SPECIFICATIONS SHEET – EC50440 (08/2014)

REFERENCE NUMBER AND TITLE EC 50440 (08/2014) Envelope for Rejected Ballots / Enveloppe pour bulletins de vote rejetés

STYLE: Centre Seam

SIZE: 6.5" wide x 9.5" long plus 1.5" flap – open end

ADHESIVE: On Flap: 1" x 5" glue on flap

PRINTING: Prints black on the front (including flap)
FSC logo prints in black in back of envelope (logo supplied by printer)
No bleed

On Flap: Official Seal and line print in black on the flap

INK: Black

STOCK: Natural Kraft, 24lb from recycled paper or equivalent
Must be FSC stock

IMAGE:

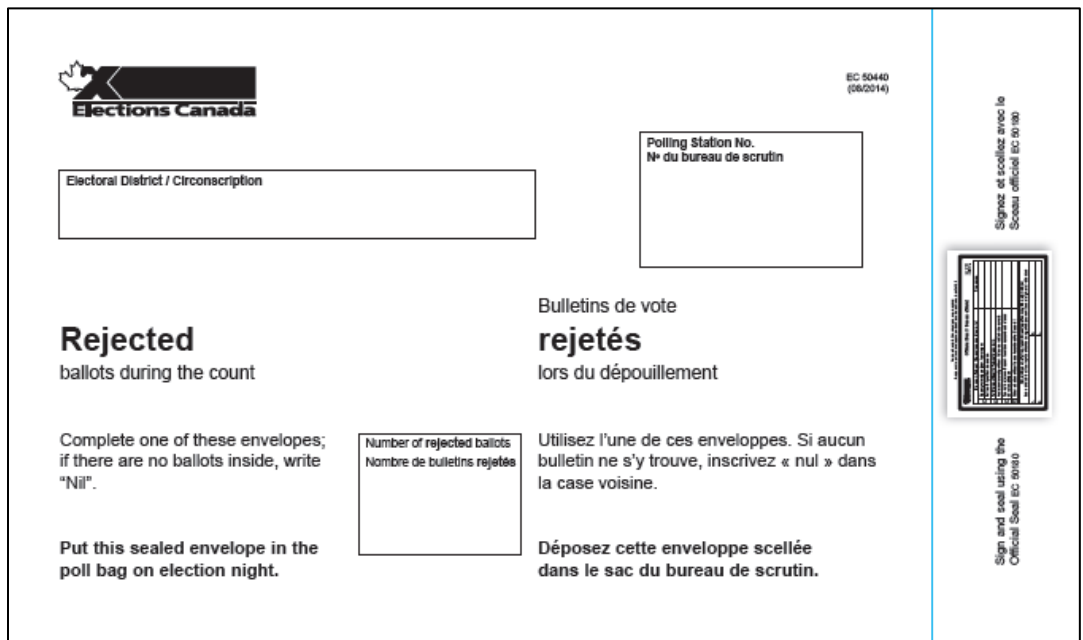

COMPONENT: PDF supplied.
Similar sample envelope is available upon request.

PROOF: One proof is required for approval before production. Please send to Elections Canada, FREM Directorate, 30 Victoria Street, 10th Floor, Gatineau QC K1A 0M6. Attention: SMS Team

QUANTITY: 130,000 envelopes

OVER:

No over / No under

Items received by Elections Canada in excess of the allowable overage as stipulated in this specification are not to be invoiced. It is the supplier's responsibility to ensure that items are not shipped in excess of the allowable overage

ADDITIONAL QUANTITY (OPTION):

Elections Canada may require additional quantity within the period of the resulting contract. Specifications will remain unchanged.

The supplier will grant to Elections Canada the irrevocable option to acquire the additional quantity at the prices stated in the resulting contract. The option may only be exercised by the Contracting Authority and will be evidenced, for administrative purposes only, through a contract amendment.

Within the quotation, in addition to the cost for the initial quantity, please provide:

- A separate unit cost for up to 50% of the original quantity for each item.
- A separate unit cost for up to 100% of the original quantity for each item.
- Elections Canada makes no guarantee that this option will be exercised during the period of the contract.

PACKAGING:

In corrugated boxes. Each box not to weigh more than 35 lbs. Clearly identify each box as to content in a minimum 20 pt type size.

Label on Boxes:

<p><i>EC 50440 (08/2014)</i> <i>Envelope for Rejected Ballots /</i> <i>Enveloppe pour bulletins de vote</i> <i>rejetés</i> <i>Qty/Qté - XXX</i></p>
--

NOTE: Labeling of items going to the Distribution Centre must be exactly as indicated. If not, they will not be accepted.

QUOTE SUBMISSION:

Your quotation must show cost per unit and must include the transportation fee.

MANDATORY DELIVERY DATE:

October 27, 2014 or sooner

PART 8 - SPECIFICATIONS SHEET – EC50460 (08/2014)

REFERENCE NUMBER AND TITLE EC 50460 (08/2014) Document Envelope

STYLE: Centre Seam

SIZE: 9.5" wide x 15" long plus 3.5" flap – open end

GUSSET: 2" gussets expansion all around

ADHESIVE: 1.25" x 8.75" glue on flap, and also glue on the back – latex re-sealable envelope

PRINTING: Prints black on the front (including flap)
FSC logo prints in black in the back of envelope (logo supplied by printer)
No bleed

On Flap: Official Seal and line print in black on the flap

INK: Black

STOCK: White Wove 32 lb or equivalent
Must be FSC stock

IMAGE:

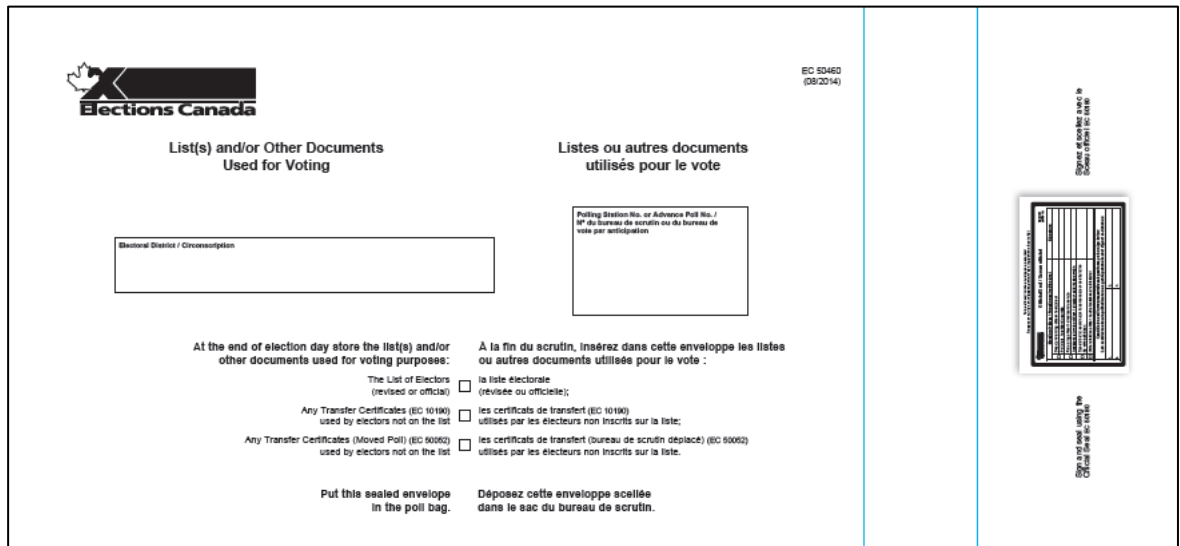

- COMPONENT:** PDF supplied.
Sample of a similar envelope is available upon request.
- PROOF:** One proof is required for approval before production. Please send to Elections Canada, FREM Directorate, 30 Victoria Street, 10th Floor, Gatineau QC K1A 0M6. Attention: SMS Team
- QUANTITY:** 150,000 envelopes
- OVER:** ***No over / No under***
Items received by Elections Canada in excess of the allowable overage as stipulated in this specification are not to be invoiced. It is the supplier's responsibility to ensure that items are not shipped in excess of the allowable overage
- ADDITIONAL QUANTITY (OPTION):** Elections Canada may require additional quantity within the period of the resulting contract. Specifications will remain unchanged.
- The supplier will grant to Elections Canada the irrevocable option to acquire the additional quantity at the prices stated in the resulting contract. The option may only be exercised by the Contracting Authority and will be evidenced, for administrative purposes only, through a contract amendment.
- Within the quotation, in addition to the cost for the initial quantity, please provide:
- A separate unit cost for up to 50% of the original quantity for each item.
 - A separate unit cost for up to 100% of the original quantity for each item.
 - Elections Canada makes no guarantee that this option will be exercised during the period of the contract.

PACKAGING:

In corrugated boxes. Each box not to weigh more than 35 lbs. Clearly identify each box as to content in a minimum 20 pt type size.

Label on Boxes:

<p><i>EC 50460 (08/2014)</i> <i>Document Envelope / Enveloppe pour documents</i> <i>Qty/Qté – XXX</i></p>
--

NOTE: Labeling of items going to the Distribution Centre must be exactly as indicated. If not, they will not be accepted.

QUOTE SUBMISSION:

Your quotation must show cost per unit and must include the transportation fee.

MANDATORY DELIVERY DATE:

October 27, 2014 or sooner

PART 9 - ADDITIONAL INSTRUCTIONS AND SHIPPING REQUIREMENTS

SHIPPING INSTRUCTIONS: Ship on non-returnable shipping skids 48" wide by 42" deep not to exceed 54" high stacking height. The material must be accessible by hand held hydraulic pallet movers.

SKIDS: Brewery type skid – 4 way entry type, 48" wide by 42" deep, 3 stringers with three blocks, each running 48" long

NOTE: Items shipped to the Distribution Centre not on requested skids will not be accepted upon delivery.

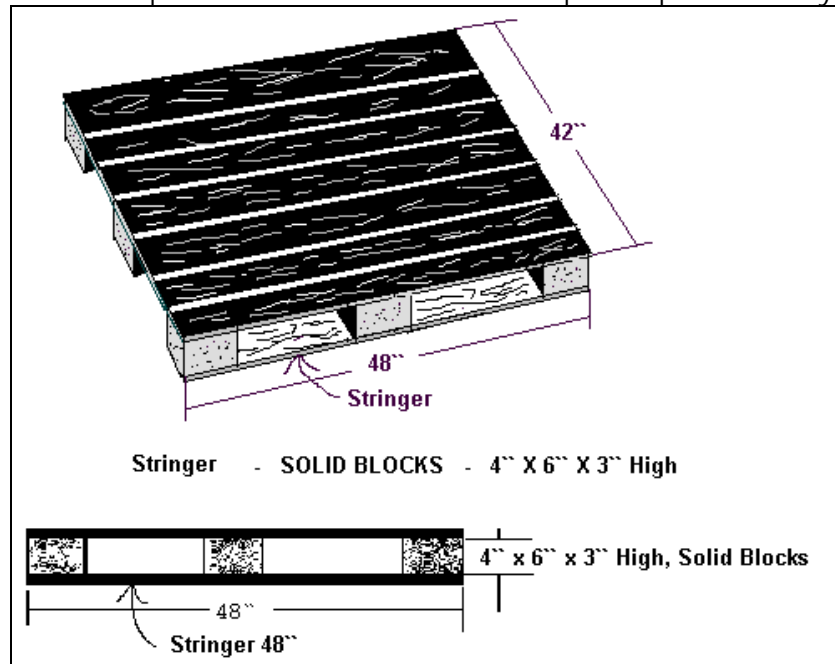

HOURS OF OPERATION : 8 a.m. to 12:00 noon / 1:00 p.m. to 4:00 p.m.

DESTINATION: Elections Canada Distribution Centre
100-440 Coventry Road, Ottawa, Ontario K1K 2Y5

INVOICE Please send your invoice to the following address:
Jocelyne Leroux
SMS Team
Elections Canada
30 Victoria Street, Room 10-A-005
Gatineau, Quebec K1A 0M6

It is the responsibility of the supplier to provide a valid tax registration number for: HST, GST and QST, as applicable. Elections Canada will not validate tax registration numbers. If applicable taxes are invoiced without a tax registration number(s), Elections Canada will not pay the applicable tax(es).

ADDITIONAL INFORMATION:

Invoices must indicate the Purchase Order number, if applicable, the Reference Number, the revision date and show any correction cost breakdown whenever it is applicable. No change in these specifications will be accepted unless approved by the project authority.

Elections Canada must be informed of the cost of any author's alterations as soon as possible. A contract amendment must be made as soon as any changes affecting cost occur.

The printer is to return to Elections Canada a final electronic file properly identified with all or any corrections made at the proofing stage before invoices are approved for payment.

Wrapping and shipping instructions must be followed to the letter or the Distribution Centre may refuse to accept the shipment.

Annex B – Pricing Table

GROUPE 1

The Contractor will be paid in accordance with the firm all inclusive rates outlined below for the services outlined in Annex A – Specifications. Pricing is for the full period of the contract and does not include applicable sales tax.

1.0 INITIAL QUANTITY

Item #	Description	Unit of Measure	Quantity	Firm Unit Price	Firm Extended Price
1.	EC 50370 (08/2014) Envelope for White Copy of the Statement of the Votes	Singles	120,000		
2.	EC 50380 (08/2014) Envelope for yellow copy of the Statement of the Votes	Singles	120,000		
3.	EC 50400 (08/2014) Envelope for Daily Ballots Cast – Advance Poll	Sets of 4	12,000		
4.	EC50410 (08/2014) - Envelope for Mobile Poll Ballots Cast	Sets of 4	5,000		
5.	EC 50420 (08/2014) Envelope for Unused Ballot	Singles	110,000		
6.	EC 50420 (08/2014) Envelope for Unused Ballot	Sets of 4	5,500		
7.	EC 50421 (08/2014) Envelope – Record of Votes Cast and Unused Ballots for Advance Poll	Sets of 4	12,000		
8.	EC 50450 (08/2014) Envelope for Ballots Cast	Sets of 7	130,000		
TOTAL COST – INITIAL QUANTITY					

TO A MAXIMUM OF \$ [insert at contract award] (applicable taxes extra)

All payments are subject to Government Audit.

2.0 OPTION 1 – 50% of the INITIAL QUANTITY

Item #	Description	Unit of Measure	Quantity	Firm Unit Price	Firm Extended Price
1.	EC 50370 (08/2014) Envelope for White Copy of the Statement of the Votes	Singles	60,000		
2.	EC 50380 (08/2014) Envelope for yellow copy of the Statement of the Votes	Singles	60,000		
3.	EC 50400 (08/2014) Envelope for Daily Ballots Cast – Advance Poll	Sets of 4	6,000		
4.	EC50410 (08/2014) - Envelope for Mobile Poll Ballots Cast	Sets of 4	2,500		
5.	EC 50420 (08/2014) Envelope for Unused Ballot	Singles	55,000		
6.	EC 50420 (08/2014) Envelope for Unused Ballot	Sets of 4	2,750		
7.	EC 50421 (08/2014) Envelope – Record of Votes Cast and Unused Ballots for Advance Poll	Sets of 4	6,000		
8.	EC 50450 (08/2014) Envelope for Ballots Cast	Sets of 7	65,000		
TOTAL COST – OPTION 1					

3.0 OPTION 2 – 100% of the INITIAL QUANTITY

Item #	Description	Unit of Measure	Quantity	Firm Unit Price	Firm Extended Price
1.	EC 50370 (08/2014) Envelope for White Copy of the Statement of the Votes	Singles	120,000		
2.	EC 50380 (08/2014) Envelope for yellow copy of the Statement of the Votes	Singles	120,000		
3.	EC 50400 (08/2014) Envelope for Daily Ballots Cast – Advance Poll	Sets of 4	12,000		
4.	EC50410 (08/2014) - Envelope for Mobile Poll Ballots Cast	Sets of 4	5,000		
5.	EC 50420 (08/2014) Envelope for	Singles	110,000		

	Unused Ballot				
6.	EC 50420 (08/2014) Envelope for Unused Ballot	Sets of 4	5,500		
7.	EC 50421 (08/2014) Envelope – Record of Votes Cast and Unused Ballots for Advance Poll	Sets of 4	12,000		
8.	EC 50450 (08/2014) Envelope for Ballots Cast	Sets of 7	130,000		
	TOTAL COST – OPTION 2				

Annex B – Pricing Table

GROUPE 2

The Contractor will be paid in accordance with the firm all inclusive rates outlined below for the services outlined in Annex A – Specifications. Pricing is for the full period of the contract and does not include applicable sales tax.

1.0 INITIAL QUANTITY

Item #	Description	Unit of Measure	Quantity	Firm Unit Price	Firm Extended Price
1.	EC 50385 (08/2014) Envelope for EC 50111	Single of 1	116,000		
2.	EC 50390 (08/2014) Registration and/or Correction Certificates	Single of 1	140,000		
3.	EC 50390 (08/2014) Registration and/or Correction Certificates	Sets of 4	22,000		
4.	EC 50422 (08/2014) Oath of Residence Envelope	Single of 1	113,000		
5.	EC 50422 (08/2014) Oath of Residence Envelope	Sets of 4	11,000		
6.	EC 50423 (08/2014) Candidates' Rep Authorization/Sign-in Envelope	Single of 1	49,000		
7.	EC 50430 (08/2014) Envelope for Spoiled Ballot Papers	Single of 1	110,000		
8.	EC 50430 (08/2014) Envelope for Spoiled Ballot Papers	Sets of 4	5,000		
9.	EC 50431 (08/2014) Envelope for Spoiled ballot paper – Advance Poll	Sets of 4	12,000		
10.	EC 50440 (08/2014) Envelope for Rejected Ballots	Single of 1	130,000		
11.	EC 50460 (08/2014) Document Envelope Cast	Single of 1	150,000		
	TOTAL COST – INITIAL QUANTITY				

TO A MAXIMUM OF \$ [insert at contract award] (applicable taxes extra)

All payments are subject to Government Audit.

2.0 OPTION 1 – 50% of the INITIAL QUANTITY

Item #	Description	Unit of Measure	Quantity	Firm Unit Price	Firm Extended Price
1.	EC 50385 (08/2014) Envelope for EC 50111	Single of 1	58,000		
2.	EC 50390 (08/2014) Registration and/or Correction Certificates	Single of 1	70,000		
3.	EC 50390 (08/2014) Registration and/or Correction Certificates	Sets of 4	11,000		
4.	EC 50422 (08/2014) Oath of Residence Envelope	Single of 1	56,500		
5.	EC 50422 (08/2014) Oath of Residence Envelope	Sets of 4	5,500		
6.	EC 50423 (08/2014) Candidates' Rep Authorization/Sign-in Envelope	Single of 1	24,500		
7.	EC 50430 (08/2014) Envelope for Spoiled Ballot Papers	Single of 1	55,000		
8.	EC 50430 (08/2014) Envelope for Spoiled Ballot Papers	Sets of 4	2,500		
9.	EC 50431 (08/2014) Envelope for Spoiled ballot paper – Advance Poll	Sets of 4	6,000		
10.	EC 50440 (08/2014) Envelope for Rejected Ballots	Single of 1	65,000		
11.	EC 50460 (08/2014) Document Envelope Cast	Single of 1	75,000		
TOTAL COST – OPTION1					

3.0 OPTION 2 – 100% of the INITIAL QUANTITY

Item #	Description	Unit of Measure	Quantity	Firm Unit Price	Firm Extended Price
1.	EC 50385 (08/2014) Envelope for EC 50111	Single of 1	116,000		
2.	EC 50390 (08/2014) Registration and/or Correction Certificates	Single of 1	140,000		
3.	EC 50390 (08/2014) Registration and/or Correction Certificates	Sets of 4	22,000		
4.	EC 50422 (08/2014) Oath of Residence Envelope	Single of 1	113,000		
5.	EC 50422 (08/2014) Oath of	Sets of 4	11,000		

	Residence Envelope				
6.	EC 50423 (08/2014) Candidates' Rep Authorization/Sign-in Envelope	Single of 1	49,000		
7.	EC 50430 (08/2014) Envelope for Spoiled Ballot Papers	Single of 1	110,000		
8.	EC 50430 (08/2014) Envelope for Spoiled Ballot Papers	Sets of 4	5,000		
9.	EC 50431 (08/2014) Envelope for Spoiled ballot paper – Advance Poll	Sets of 4	12,000		
10.	EC 50440 (08/2014) Envelope for Rejected Ballots	Single of 1	130,000		
11.	EC 50460 (08/2014) Document Envelope Cast	Single of 1	150,000		
	TOTAL COST – OPTION 2				

Annex C
General Conditions
Mixed Goods and Services

Article 1 Interpretation

Section 1.01 Definitions

1.01.01 In the Contract, unless the context otherwise requires:

- “Articles of Agreement” means the clauses and conditions incorporated in full text in the body of the Contract; it does not include these general conditions, any supplemental general conditions, annexes, the Contractor’s bid or any other document;
- “Canada” means Her Majesty the Queen in right of Canada;
- “Contract” means the Articles of Agreement, these general conditions, any supplemental general conditions, annexes and any other document specified or referred to as forming part of the Contract, all as amended by agreement of the Parties from time to time;
- “Contracting Authority” means the person designated by that title in the Contract, or by notice to the Contractor, to act as Elections Canada’s representative to manage the Contract;
- “Contractor” means the person, entity or entities named in the Contract to supply goods, services or both to Elections Canada;
- “Contract Price” means the amount stated in the Contract to be payable to the Contractor for the Work, exclusive of applicable sales tax;
- “Cost” means cost determined according to Contract Cost Principles 1031-2 as revised to the date of the bid solicitation or, if there was no bid solicitation, the date of the Contract.
- “EC Property” means anything supplied to the Contractor by or on behalf of Elections Canada for the purposes of performing the Contract and anything acquired by the Contractor in any manner in connection with the Work, the cost of which is paid by Elections Canada under the Contract;
- “Elections Canada” means the Chief Electoral Officer and any other person duly

authorized to act on his behalf;

“Party”	means Elections Canada, the Contractor, or any other signatory to the Contract and "Parties" means all of them;
“Specifications”	means the description of the essential, functional or technical requirements of the Work in the Contract, including the procedures for determining whether the requirements have been met; and
“Work”	means all the activities, services, goods, equipment, matters and things required to be done, delivered or performed by the Contractor under the Contract.

Section 1.02 Powers of Elections Canada

All rights, remedies, powers and discretions granted or acquired by Elections Canada under the Contract or by law are cumulative, not exclusive.

Section 1.03 Status of the Contractor

The Contractor is an independent contractor engaged by Elections Canada to perform the Work. Nothing in the Contract is intended to create a partnership, a joint venture or an agency between Elections Canada and the other Party or Parties. The Contractor must not represent itself as an agent or representative of Elections Canada to anyone. Neither the Contractor nor any of its personnel is engaged as an employee or agent of Elections Canada. The Contractor is responsible for all deductions and remittances required by law in relation to its employees.

Section 1.04 Severability

If any provision of the Contract is declared by a court of competent jurisdiction to be unenforceable, that provision is to be either adjusted the minimum necessary to make it enforceable (if permitted by law) or stricken (if not). If adjusting or striking the unenforceable provision would result in failure of an essential purpose of this agreement, the entire agreement is to be held unenforceable. After an unenforceable provision is adjusted or stricken in accordance with this Section 1.04, the rest of the Contract is to remain in effect as written and the unenforceable provision is to remain as written in any circumstances other than those in which the provision is held to be unenforceable.

Section 1.05 Entire Agreement

The Contract constitutes the entire and only agreement between the Parties and supersedes all previous negotiations, communications and other agreements, whether written or oral, unless they are incorporated by reference in the Contract. There are no terms, covenants, representations, statements or conditions binding on the Parties other than those contained in the Contract.

Article 2 Conduct of the Work

Section 2.01 Representation and Warranties

2.01.01 The Contractor represents and warrants that:

- (a) it is competent to perform the Work;
- (b) it has everything necessary to perform the Work, including the resources, facilities, labour, technology, equipment, and materials; and
- (c) it has the necessary qualifications, including knowledge, skill, know-how and experience, and the ability to use them effectively to perform the Work.

2.01.02 The Contractor must:

- (a) perform the Work diligently and efficiently;
- (b) except for EC Property, supply everything necessary to perform the Work;
- (c) use, as a minimum, quality assurance procedures, inspections and controls generally used and recognized by the industry to ensure the degree of quality required by the Contract; and
- (d) ensure that the Work is of proper quality, using appropriate material and workmanship and meets all the requirements of the Contract.

2.01.03 Unless the Contracting Authority orders the Contractor to suspend the Work or part of the Work pursuant to Article 19 (Suspension of Work), the Contractor must not stop or suspend the Work or part of the Work pending the settlement of any dispute between the Parties about the Contract.

2.01.04 The Contractor must provide all reports that are required by the Contract and any other information that Elections Canada may reasonably require from time to time.

2.01.05 The Contractor is fully responsible for performing the Work. Elections Canada will not be responsible for any negative consequences or extra costs if the Contractor follows any advice given by Elections Canada unless the Contracting Authority provides the advice to the Contractor in writing and includes a statement specifically relieving the Contractor of any responsibility for negative consequences or extra costs that might result from following the advice.

Article 3 Work

Section 3.01 Specification

3.01.01 All Specifications provided by Elections Canada or on behalf of Elections Canada to the

Contractor in connection with the Contract belong to Elections Canada and must be used by the Contractor only for the purpose of performing the Work.

- 3.01.02 If the Contract provides that Specifications furnished by the Contractor must be approved by Elections Canada, that approval will not relieve the Contractor of its responsibility to meet all requirements of the Contract.

Section 3.02 Condition of Material

- 3.02.01 Unless provided otherwise in the Contract, material supplied must be new and conform to the latest issue of the applicable drawing, specifications and part number that is in effect on the bid closing date or, if there was no bid solicitation, the date of the Contract.

Section 3.03 Replacement of Specific Individuals

- 3.03.01 If specific individuals are identified in the Contract to perform the Work, the Contractor must provide the services of those individuals unless the Contractor is unable to do so for reasons beyond its control.
- 3.03.02 If the Contractor is unable to provide the services of any specific individual identified in the Contract, it must provide a replacement with similar qualifications and experience. The replacement must meet the criteria used in the selection of the Contractor and be acceptable to Elections Canada. The Contractor must, as soon as possible, give notice to the Contracting Authority of the reason for replacing the individual and provide:
- (a) the name, qualifications and experience of the proposed replacement; and
 - (b) proof that the proposed replacement has the required security clearance granted by Elections Canada or Canada, if applicable.
- 3.03.03 Upon receiving the notice of replacement of a specific individual, if the Contracting Authority determines that the replacement is acceptable to Elections Canada, the Contracting Authority shall send a written notice to the Contractor confirming its acceptance of the replacement.
- 3.03.04 The Contractor must not, in any event, allow performance of the Work by unauthorized replacement persons. The Contracting Authority may order that a replacement stop performing the Work. In such a case, the Contractor must immediately comply with the order and secure a further replacement in accordance with Subsection 3.03.02. The fact that the Contracting Authority does not order that a replacement stop performing the Work does not relieve the Contractor from its responsibility to meet the requirements of the Contract.

Section 3.04 Inspection and Acceptance of the Work

- 3.04.01 All the Work is subject to inspection and acceptance by Elections Canada. Inspection and

acceptance of the Work by Elections Canada do not relieve the Contractor of its responsibility for defects or other failures to meet the requirements of the Contract. Elections Canada will have the right to reject any work that is not in accordance with the requirements of the Contract and require its correction or replacement at the Contractor's expense.

- 3.04.02 The Contractor must provide representatives of Elections Canada access to all locations where any part of the Work is being performed at any time during working hours. Representatives of Elections Canada may make examinations and such tests of the Work as they may think fit. The Contractor must provide all assistance and facilities, test pieces, samples and documentation that the representatives of Elections Canada may reasonably require for the carrying out of the inspection. The Contractor must forward such test pieces and samples to such person or location as Elections Canada specifies.
- 3.04.03 The Contractor must inspect and approve any part of the Work before submitting it for acceptance or delivering it to Elections Canada. The Contractor must keep accurate and complete inspection records that must be made available to Elections Canada on request. Representatives of Elections Canada may make copies and take extracts of the records during the performance of the Contract and for up to three years after the end of the Contract.

Section 3.05 Time of the Essence

It is essential that the Work be delivered within or at the time stated in the Contract.

Article 4 Subcontracts

Section 4.01 Consent

- 4.01.01 Except as provided in Subsection 4.01.02, the Contractor must obtain the Contracting Authority's written consent before subcontracting or permitting the subcontracting of any part of the Work. A subcontract includes a contract entered into by any subcontractor at any tier to perform any part of the Work.
- 4.01.02 The Contractor is not required to obtain consent for subcontracts specifically authorized in the Contract. The Contractor may also without the consent of the Contracting Authority:
- (a) purchase "off-the-shelf" items and any standard articles and materials that are ordinarily produced by manufacturers in the normal course of business;
 - (b) subcontract any services that form part of the Work if it is customary in the carrying out of similar contracts; and
 - (c) with respect to goods or part thereof to be delivered as part of the work, subcontract any part or parts of the Work to one or more subcontracts up to a total value of 40 percent of the Contract Price; and;

- (d) permit its subcontractors at any tier to make purchases or subcontract as permitted in Paragraphs (a) and (b).

Section 4.02 Subcontractor to be bound by Contract

- 4.02.01 In any subcontract other than a subcontract referred to in Paragraph 4.01.02(a), the Contractor must, unless the Contracting Authority agrees in writing, ensure that the subcontractor is bound by conditions compatible with and, in the opinion of the Contracting Authority, not less favourable to Elections Canada than the conditions of the Contract.
- 4.02.02 Even if Elections Canada consents to a subcontract, the Contractor is responsible for performing the Contract and Elections Canada is not responsible to any subcontractor. The Contractor is responsible for any matters or things done or provided by any subcontractor under the Contract and for paying any subcontractors for any part of the Work they perform.

Article 5 Harassment in the Workplace

Section 5.01 No tolerance

The Contractor must not, either as an individual, or as a corporate or unincorporated entity, through its employees or subcontractors, harass, abuse, threaten, discriminate against or intimidate any employee, contractor or other individual employed by, or under contract with Elections Canada. The Contractor will be advised in writing of any complaint and will have the right to respond in writing. Upon receipt of the Contractor's response, the Contracting Authority will, at its entire discretion, determine if the complaint is founded and decide on any action to be taken, which action may be termination of the Contract by reason of default by the Contractor.

Article 6 Payment

Section 6.01 Invoice Submission

- 6.01.01 Invoices must be submitted in the Contractor's name. The Contractor must submit invoices for each delivery or shipment; invoices must only apply to the Contract. Each invoice must indicate whether it covers partial or final delivery.
- 6.01.02 Invoices must show:
 - (a) the date, the name and address of Elections Canada, item or reference numbers, deliverable and/or description of the Work, contract number, Procurement Business Number (PBN), the Contractor's business number for tax remission purposes, and financial code(s);
 - (b) details of expenditures in accordance with the basis of payment provision in the

Articles of Agreement, exclusive of applicable sales tax (such as item, quantity, unit of issue, unit price, fixed time labour rates and level of effort, subcontracts, as applicable);

(c) deduction for holdback, if applicable;

(d) the extension of the totals, if applicable; and

(e) if applicable, the method of shipment together with date, case numbers and part or reference numbers, shipment charges and any other additional charges.

6.01.03 Applicable sales tax must be specified on all invoices as a separate item together with the corresponding registration number issued by the appropriate tax authority. All items that are zero-rated, exempt or to which no sales tax applies, must be identified as such on all invoices.

6.01.04 By submitting an invoice, the Contractor certifies that the invoice is consistent with the Work delivered and is in accordance with the Contract.

Section 6.02 Payment Period

6.02.01 Provided that Elections Canada has received a duly signed original copy of the Contract, Elections Canada's standard payment period is 30 days. The payment period will commence the date the invoice, in acceptable form and content, is received in accordance with the Contract or the date the Work is delivered in acceptable condition as required in the Contract, whichever is later. A payment is considered overdue on the 31st day following that date and interest will be paid automatically in accordance with Section 6.04.

6.02.02 If the content of the invoice and its substantiating documentation are not in accordance with the Contract or the Work is not in acceptable condition, Elections Canada will notify the Contractor within 15 days of receipt. The 30-day payment period begins upon receipt of the revised invoice or replacement invoice or the Work being corrected. Failure by Elections Canada to notify the Contractor within 15 days will only result in the date specified in Subsection 6.02.01 to apply for the sole purpose of calculating interest on overdue accounts.

Section 6.03 Withholding of Payment

6.03.01 Where a delay referred to in Article 18 – Excusable Delay has occurred, Elections Canada may, at Elections Canada's discretion, withhold all or a portion of any payment due to the Contractor until a "work-around" plan approved by Elections Canada has been implemented in accordance with Section 18.01. Section 6.04 shall not apply to any amount withheld under this Subsection.

Section 6.04 Interest on Overdue Accounts

6.04.01 For the purpose of this Section:

“Average Rate” means the simple arithmetic mean of the Bank Rates in effect at 4:00 p.m. Eastern Time each day during the calendar month immediately before the calendar month in which payment is made;

“Bank Rate” means the rate of interest established from time to time by the Bank of Canada as the minimum rate at which the Bank of Canada makes short term advances to members of the Canadian Payments Association;

“date of payment” means the date of the negotiable instrument drawn by the Receiver General for Canada to pay any amount under the Contract; and

an amount becomes “overdue” when it is unpaid on the first day following the day on which it is due and payable according to the Contract.

6.04.02 Elections Canada will pay to the Contractor simple interest at the Average Rate plus 3 percent per year on any amount that is overdue, from the date that amount becomes overdue until the day before the date of payment, inclusive. The Contractor is not required to provide notice to Elections Canada for interest to be payable.

6.04.03 Elections Canada will pay interest in accordance with this Section only if Elections Canada is responsible for the delay in paying the Contractor. Elections Canada will not pay interest on overdue advance payments.

Article 7 Accounts and Audit

Section 7.01 Accounts and Audit

7.01.01 The Contractor must keep proper accounts and records of the cost of performing the Work and of all expenditures or commitments made by the Contractor in connection with the Work, including all invoices, receipts and vouchers. The Contractor must retain records, including bills of lading and other evidence of transportation or delivery, for all deliveries made under the Contract.

7.01.02 If the Contract includes payment for time spent by the Contractor, its employees, representatives, agents or subcontractors performing the Work, the Contractor must keep a record of the actual time spent each day by each individual performing any part of the Work.

7.01.03 Unless Elections Canada has consented in writing to its disposal, the Contractor must retain all the information described in this Section for six years after it receives the final payment under the Contract, or until the settlement of all outstanding claims and disputes, whichever is later. During this time, the Contractor must make this information available for audit, inspection and examination by the representatives of Elections Canada, who may make copies and take extracts. The Contractor must provide all reasonably required

facilities for any audit and inspection and must furnish all the information as the representatives of Elections Canada may from time to time require to perform a complete audit of the Contract.

- 7.01.04 The amount claimed under the contract, calculated in accordance with the basis of payment provision in the Articles of Agreement, is subject to audit both before and after payment is made. If an audit is performed after payment, the Contractor agrees to repay any overpayment immediately on demand by Elections Canada. Elections Canada may hold back, deduct and set off any credits owing and unpaid under this Section from any money that Elections Canada owes to the Contractor at any time (including under other contracts). If Elections Canada does not choose to exercise this right at any given time, Elections Canada does not lose this right.

Article 8 Taxes

Section 8.01 Municipal Taxes

Municipal Taxes do not apply.

Section 8.02 Provincial Taxes Exemption

- 8.02.01 Except as provided by law, Elections Canada is not required to pay any sales tax payable to the province in which the taxable goods or services are delivered. This exemption has been provided to federal government departments and agencies under the authority of one of the following:

(a) Provincial Sales Tax (PST) Exemption Licence Numbers, for the provinces of:

- i. British Columbia PST-1000-5001;
- ii. Manitoba 390-516-0;

(b) for Saskatchewan, the Yukon Territory, the Northwest Territories and Nunavut, an Exemption certification, which certifies that the goods or services purchased by Elections Canada are not subject to the provincial and territorial sales and consumption taxes because they are purchased by a federal government department or agency with Canada funds for the use of Elections Canada.

- 8.02.02 Currently, in Alberta, the Yukon Territory, the Northwest Territories and Nunavut, there is no general PST. However, if a PST is introduced in Alberta, the Yukon Territory, the Northwest Territories or Nunavut, PST will be payable unless an exemption certification is included in the purchasing document.

Section 8.03 Harmonized Sales Tax

Elections Canada must pay the HST in the participating provinces of Newfoundland and Labrador, Nova Scotia, New Brunswick, Ontario and Prince Edward Island.

Section 8.04 Quebec Sales Tax

Elections Canada must pay the Quebec Sales Tax in the province of Quebec.

Section 8.05 Provincial Taxes paid by the Contractor

The Contractor is not exempt from paying PST under the above Exemption Licence Numbers or Exemption Certification. The Contractor must pay the PST on taxable goods or services used or consumed in the performance of the Contract (in accordance with applicable provincial legislation), including material incorporated into real property.

Section 8.06 Changes to Taxes and Duties

8.06.01 If there is any change to any tax or duty payable to any level of government in Canada after the bid submission date that affects the costs of the Work to the Contractor, the Contract Price will be adjusted to reflect the increase or decrease in the cost to the Contractor.

8.06.02 However, there will be no adjustment for any change that increases the cost of the Work to the Contractor if public notice of the change was given before bid submission date in sufficient detail to have permitted the Contractor to calculate the effect of the change on its cost. There will be no adjustment if the change takes effect after the date required by the Contract for delivery of the Work.

Section 8.07 Applicable Sales Tax

The estimated amount of applicable sales tax is included in the total estimated cost on page 1 of the Contract. The applicable sales tax is not included in the Contract Price but will be paid by Elections Canada as provided in the Invoice Submission Section above. The Contractor agrees to remit to the appropriate government agency any amounts of applicable sales tax paid or due.

Section 8.08 Tax Withholding of 15 Percent

Pursuant to the *Income Tax Act*, 1985, c. 1 (5th Supp.) and the *Income Tax Regulations*, Elections Canada must withhold 15 percent of the amount to be paid to the Contractor in respect of services provided in Canada if the Contractor is a non-resident unless the Contractor obtains a valid waiver. The amount withheld will be held on account for the Contractor in respect to any tax liability which may be owed to Canada.

Article 9 Transportation Costs and Carriers' Liability

Section 9.01 Transportation Costs and Carriers' Liability

9.01.01 If transportation costs are payable by Elections Canada under the Contract and the Contractor makes the transportation arrangements, shipments must be made by the most direct and economical means consistent with normal shipping practice. The costs must be

shown as a separate item on the invoice.

- 9.01.02 In light of the federal government’s policy of underwriting its own risks, Elections Canada is precluded to pay for insurance or valuation charges for transportation beyond the point at which ownership of goods passes to it (determined by the FOB point or Incoterms). Where increased carrier liability is available without charge, the Contractor must obtain the increased liability for shipment.

Article 10 Shipment Documentation

For the shipment of goods, the transportation bill of lading must accompany the original invoice, except for “collect” shipments (if and when stipulated), in which event it must accompany the shipment. In addition, a packing slip must accompany each shipment, showing item, quantity, part or reference numbers, description of the goods and contract number, including the PBN. If the goods have been inspected at the Contractor’s plant, the signed inspection voucher must be attached to the packing slip normally enclosed in the packing note envelope.

Article 11 Ownership

- 11.01.01 Unless provided otherwise in the Contract, the Work or any part of the Work belongs to Elections Canada after delivery and acceptance by or on behalf of Elections Canada.
- 11.01.02 However if any payment is made to the Contractor for or on account of any Work, either by way of progress or milestone payments, that Work paid for by Elections Canada belongs to Elections Canada upon such payment being made. This transfer of ownership does not constitute acceptance by Elections Canada of the Work or any part of the Work and does not relieve the Contractor of its obligation to perform the Work in accordance with the Contract.
- 11.01.03 Despite any transfer of ownership, the Contractor is responsible for any loss or damage to the Work or any part of the Work until it is delivered to Elections Canada in accordance with the Contract. Even after delivery, the Contractor remains responsible for any loss or damage to any part of the Work caused by the Contractor or any subcontractor.
- 11.01.04 Upon transfer of ownership to the Work or any part of the Work to Elections Canada, the Contractor must, if requested by Elections Canada, establish to Elections Canada’s satisfaction that the title is free and clear of all claims, liens, attachments, charges or encumbrances. The Contractor must execute any conveyances and other instruments necessary to perfect the title that Elections Canada may require.

Article 12 Elections Canada Property

- 12.01.01 All EC Property must be used by the Contractor solely for the purpose of the Contract and remains the property of Elections Canada. The Contractor must maintain adequate accounting records of all EC Property and, whenever feasible, mark it as being the property of Elections Canada.

- 12.01.02 The Contractor must take reasonable and proper care of all EC Property while it is in its possession or subject to its control. The Contractor is responsible for any loss or damage resulting from its failure to do so other than loss or damage caused by ordinary wear and tear.
- 12.01.03 All EC Property, unless it is installed or incorporated in the Work, must be returned to Elections Canada on demand. All scrap and all waste materials, articles or things that are EC Property must, unless provided otherwise in the Contract, remain the property of Elections Canada and must be disposed of only as directed by Elections Canada.
- 12.01.04 At the time of completion of the Contract, and if requested by the Contracting Authority, the Contractor must provide to Elections Canada an inventory of all EC Property relating to the Contract.

Article 13 Warranty

- 13.01.01 Despite inspection and acceptance of the Work by or on behalf of Elections Canada and without restricting any other provision of the Contract or any condition, warranty or provision imposed by law, the Contractor warrants that, for 12 months (or any other period stated in the Contract), the Work will be free from all defects in design, material or workmanship, and will conform to the requirements of the Contract. The warranty period begins on the date of delivery, or if acceptance takes place at a later date, the date of acceptance. With respect to EC Property not supplied by the Contractor, the Contractor's warranty will extend only to its proper incorporation into the Work.
- 13.01.02 In the event of a defect or non-conformance in any part of the Work during the warranty period, the Contractor, at the request of Elections Canada to do so, must as soon as possible repair, replace or otherwise make good at its own option and expense the part of the Work found to be defective or not in conformance with the requirements of the Contract.
- 13.01.03 The Work or any part of the Work found to be defective or non-conforming will be returned to the Contractor's plant for replacement, repair or making good. However, when in the opinion of Elections Canada it is not expedient to remove the Work from its location, the Contractor must carry out any necessary repair or making good of the Work at that location. In such cases, the Contractor will be paid the fair and reasonable Cost (including reasonable travel and living expenses) incurred in so doing, with no allowance for profit, less an amount equal to the Cost of rectifying the defect or non-conformance at the Contractor's plant.
- 13.01.04 Elections Canada must pay the transportation cost associated with returning the Work or any part of the Work to the Contractor's plant pursuant to Subsection 13.01.03. The Contractor must pay the transportation cost associated with forwarding the replacement or returning the Work or part of the Work when rectified to the delivery point specified in the Contract or to another location directed by Elections Canada.

- 13.01.05 The Contractor must remedy all data and reports pertaining to any correction or replacement under this Section, including revisions and updating of all affected data, manuals, publications, software and drawings called for under the Contract, at no cost to Elections Canada.
- 13.01.06 If the Contractor fails to fulfill any obligation described in this Section within a reasonable time of receiving a notice, Elections Canada will have the right to remedy or to have remedied the defective or non-conforming work at the Contractor's expense. If Elections Canada does not wish to correct or replace the defective or non-conforming work, an equitable reduction will be made in the Contract Price.
- 13.01.07 The warranty period is automatically extended by the duration of any period or periods where the Work is unavailable for use or cannot be used because of a defect or non-conformance during the original warranty period. The warranty applies to any part of the Work repaired, replaced or otherwise made good pursuant to Subsection 13.01.02, for the greater of:
- (a) the warranty period remaining, including the extension, or
 - (b) ninety days or such other period as may be specified for that purpose by agreement between the Parties.

Article 14 Liability

The Contractor is liable for any damage caused by the Contractor, its employees, subcontractors or agents to Elections Canada or any third party. Elections Canada is liable for any damage caused by Elections Canada, its employees or agents to the Contractor or any third party. The Parties agree that no limitation of liability or indemnity provision applies to the Contract unless it is specifically incorporated in full text in the Articles of Agreement or specifically provided for in supplemental general conditions, which form part of the Contract. Damage includes any injury to persons (including injury resulting in death) or loss of or damage to property (including real property) caused as a result of or during the performance of the Contract.

Article 15 Confidentiality

- 15.01.01 The Contractor must keep confidential all information provided or made available to the Contractor by or on behalf of Elections Canada in connection with the Work, including any information that is confidential or proprietary to third parties, and all information conceived, developed or produced by the Contractor as part of the Work when copyright or any other intellectual property rights in such information belongs to Elections Canada under the Contract (collectively, the "EC Information"). The Contractor must not disclose any EC Information without the written permission of Elections Canada. The Contractor may disclose to a subcontractor any EC Information as long as the subcontractor agrees to keep such EC Information confidential and that it will be used only to perform the subcontract.

- 15.01.02 The Contractor agrees to use the EC Information only for the purpose of the Contract. The Contractor acknowledges that all EC Information remains the property of Elections Canada or the third party, as the case may be. Unless provided otherwise in the Contract, the Contractor must deliver to Elections Canada all such EC Information, together with every copy, draft, working paper and note that contains such information, upon completion or termination of the Contract or at such earlier time as Elections Canada may require.
- 15.01.03 Subject to the *Access to Information Act*, R.S.C. 1985, c. A-1, and to any right of Elections Canada under the Contract to release or disclose, Elections Canada must not release or disclose outside the Government of Canada any information delivered to Elections Canada under the Contract that is proprietary to the Contractor or a subcontractor.
- 15.01.04 The obligations of the Parties set out in this Article do not apply to any information if the information:
- (a) is publicly available from a source other than the other Party; or
 - (b) is or becomes known to a Party from a source other than the other Party, except any source that is known to be under an obligation to the other Party not to disclose the information; or
 - (c) is developed by a Party without use of the information of the other Party.
- 15.01.05 Wherever possible, the Contractor must mark or identify any proprietary information delivered to Elections Canada under the Contract as “Property of (Contractor’s name), permitted Government uses defined under Elections Canada Contract No. (fill in Contract Number)”. Elections Canada will not be liable for any unauthorized use or disclosure of information that could have been so marked or identified and was not.
- 15.01.06 If the Contract, the Work, or any information referred to in Subsection 15.01.01 is identified as TOP SECRET, SECRET, CONFIDENTIAL, or PROTECTED by Elections Canada, the Contractor must at all times take all measures reasonably necessary for the safeguarding of the material so identified, including those set out in the PWGSC Industrial Security Manual and its supplements and any other instructions issued by Canada.
- 15.01.07 If the Contract, the Work, or any information referred to in Subsection 15.01.01 is identified as TOP SECRET, SECRET, CONFIDENTIAL, or PROTECTED, by Elections Canada, representatives of Elections Canada are entitled to inspect the Contractor’s premises and the premises of a subcontractor at any tier for security purposes at any time during the term of the Contract. The Contractor must comply with, and ensure that any subcontractor complies with, all written instructions issued by Elections Canada dealing with the material so identified, including any requirement that employees of the Contractor or of any subcontractor execute and deliver declarations relating to reliability screenings, security clearances and other procedures.

Section 15.02 An Oath of Secrecy

The Parties hereby agree to sign any document that is necessary for the execution of this Contract, including but not limited to, an oath of secrecy pertaining to information contained in the Register of Electors, lists of electors and/or any record placed under the responsibility and/or owned by Elections Canada.

Article 16 Copyright

Section 16.01 Copyright

- 16.01.01 In this Section, “Material” means anything that is created by the Contractor as part of the Work under the Contract, that is required by the Contract to be delivered to Elections Canada and in which copyright subsists. “Material” does not include anything created by the Contractor before the date of the Contract.
- 16.01.02 Copyright in the Material belongs to Elections Canada and the Contractor must include the copyright symbol and either of the following notice on the Material: © Her Majesty the Queen in right of Canada (year) or © Sa Majesté la Reine du chef du Canada (année).
- 16.01.03 The Contractor must not use, copy, divulge or publish any Material except as is necessary to perform the Contract. The Contractor must execute any conveyance and other documents relating to copyright in the Material as Elections Canada may require.
- 16.01.04 The Contractor must provide at the request of Elections Canada a written permanent waiver of moral rights, in a form acceptable to Elections Canada, from every author that contributed to the Material. If the Contractor is the author of the Material, the Contractor permanently waives its moral rights in the Material.

Section 16.02 Use and Translation of Documentation

The Contractor agrees that Elections Canada may translate in the other official language any documentation delivered to Elections Canada by the Contractor that does not belong to Elections Canada under Section 16.01. The Contractor acknowledges that Elections Canada owns the translation and that it is under no obligation to provide any translation to the Contractor. Elections Canada agrees that any translation must include any copyright notice and any proprietary right notice that was part of the original. Elections Canada acknowledges that the Contractor is not responsible for any technical errors or other problems that may arise as a result of the translation.

Article 17 Intellectual Property Infringement and Royalties

- 17.01.01 The Contractor represents and warrants that, to the best of its knowledge, neither it nor Elections Canada will infringe any third party’s intellectual property rights in performing or using the Work, and that Elections Canada will have no obligation to pay royalties of any kind to anyone in connection with the Work.

17.01.02 If anyone makes a claim against Elections Canada or the Contractor concerning intellectual property infringement or royalties related to the Work, that Party agrees to notify the other Party in writing immediately. If anyone brings a claim against Elections Canada, Elections Canada may either defend the claim or may request that the Contractor defend Elections Canada against the claim. In either case, the Contractor agrees to participate fully in the defence and any settlement negotiations and to pay all costs, damages and legal costs incurred or payable as a result of the claim, including the amount of any settlement. Both Parties agree not to settle any claim unless the other Party first approves the settlement in writing.

17.01.03 The Contractor has no obligation regarding claims that were only made because:

- (a) Elections Canada modified the Work or part of the Work without the Contractor's consent or used the Work or part of the Work without following a requirement of the Contract;
- (b) Elections Canada used the Work or part of the Work with a product that the Contractor did not supply under the Contract (unless that use is described in the Contract or the manufacturer's specifications);
- (c) the Contractor used equipment, drawings, specifications or other information supplied to the Contractor by Elections Canada (or by someone authorized by Elections Canada); or
- (d) the Contractor used a specific item of equipment or software that it obtained because of specific instructions from the Contracting Authority; however, this exception only applies if the Contractor has included the following language in its own contract with the supplier of that equipment or software:

“[Supplier name] acknowledges that the purchased items will be used by the Elections Canada. If a third party claims that equipment or software supplied under this contract infringes any intellectual property right, [supplier name], if requested to do so by either [Contractor name] or Elections Canada, will defend both [Contractor name] and Elections Canada against that claim at its own expense and will pay all costs, damages and legal fees payable as a result of that infringement.”

Obtaining this protection from the supplier is the Contractor's responsibility and, if the Contractor does not do so, it will be responsible to Elections Canada for the claim.

17.01.04 If anyone claims that, as a result of the Work, the Contractor or Elections Canada is infringing its intellectual property rights, the Contractor must immediately do one of the following:

- (a) take whatever steps are necessary to allow Elections Canada to continue to use the

allegedly infringing part of the Work; or

- (b) modify or replace the Work to avoid intellectual property infringement, while ensuring that the Work continues to meet all the requirements of the Contract; or
- (c) take back the Work and refund any part of the Contract Price that Elections Canada has already paid.

If the Contractor determines that none of these alternatives can reasonably be achieved, or if the Contractor fails to take any of these steps within a reasonable amount of time, Elections Canada may choose either to require the Contractor to do (c), or to take whatever steps are necessary to acquire the rights to use the allegedly infringing part(s) of the Work itself, in which case the Contractor must reimburse Elections Canada for all the costs it incurs to do so.

Article 18 Excusable Delay

18.01.01 A delay in the performance by the Contractor of any obligation under the Contract that is caused by an event that

- (a) is beyond the reasonable control of the Contractor,
- (b) could not reasonably have been foreseen,
- (c) could not reasonably have been prevented by means reasonably available to the Contractor, and
- (d) occurred without the fault or neglect of the Contractor, will be considered an “Excusable Delay” if the Contractor
 - i. advises the Contracting Authority of the occurrence of the delay or of the likelihood of the delay as soon as the Contractor becomes aware of it,
 - ii. provides for approval to the Contracting Authority within 15 working days of Subparagraph i. a clear work around plan explaining in detail the steps that the Contractor proposes to take in order to minimize the impact of the event causing the delay.

18.01.02 Any delivery date or other date that is directly affected by an Excusable Delay will be postponed for a reasonable time that will not exceed the duration of the Excusable Delay.

18.01.03 However, if an Excusable Delay has continued for 30 days or more, the Contracting Authority may, by giving notice in writing to the Contractor, terminate the Contract. In such a case, the Parties agree that neither will make any claim against the other for damages, costs, expected profits or any other loss arising out of the termination or the event that contributed to the Excusable Delay. The Contractor agrees to repay immediately to Elections Canada the portion of any advance payment that is unliquidated at the date of the termination.

- 18.01.04 Unless Elections Canada has caused the delay by failing to meet an obligation under the Contract, Elections Canada will not be responsible for any costs incurred by the Contractor or any of its subcontractors or agents as a result of an Excusable Delay.
- 18.01.05 If the Contract is terminated under this Section, the Contracting Authority may require the Contractor to deliver to Elections Canada, in the manner and to the extent directed by the Contracting Authority, any completed parts of the Work not delivered and accepted before the termination and anything that the Contractor has acquired or produced specifically to perform the Contract. Elections Canada will pay the Contractor:
- (a) the value, of all completed parts of the Work delivered to and accepted by Elections Canada, based on the Contract Price, including the proportionate part of the Contractor's profit or fee included in the Contract Price; and
 - (b) the Cost to the Contractor that Elections Canada considers reasonable in respect of anything else delivered to and accepted by Elections Canada.
 - (c) The total amount paid by Elections Canada under the Contract to the date of termination and any amounts payable under this Subsection must not exceed the Contract Price.

Article 19 Suspension of the Work

- 19.01.01 The Contracting Authority may at any time, by written notice, order the Contractor to suspend or stop the Work or part of the Work under the Contract for a period of up to 180 days. The Contractor must immediately comply with any such order in a way that minimizes the cost of doing so. While such an order is in effect, the Contractor must not remove any part of the Work from any premises without first obtaining the written consent of the Contracting Authority. Within these 180 days, the Contracting Authority must either cancel the order or terminate the Contract, in whole or in part, under Article 20 (Default by the Contractor) or Article 21 (Termination for Convenience).
- 19.01.02 The Contracting Authority may, whether in the notice of the order or during the 180 days referred to in Subsection 19.01.01, request that the Contractor provide information regarding the status of the Work or outstanding invoices. The Contractor shall respond within the timeline provided in the request.
- 19.01.03 When an order is made under Subsection 19.01.01, unless the Contracting Authority terminates the Contract by reason of default by the Contractor or the Contractor abandons the Contract, the Contractor will be entitled to be paid its additional costs incurred as a result of the suspension plus a fair and reasonable profit.
- 19.01.04 When an order made under Subsection 19.01.01 is cancelled, the Contractor must resume work in accordance with the Contract as soon as practicable. If the suspension has affected the Contractor's ability to meet any delivery date under the Contract, the date for

performing the part of the Work affected by the suspension will be extended for a period equal to the period of suspension plus a period, if any, that in the opinion of the Contracting Authority, following consultation with the Contractor, is necessary for the Contractor to resume the Work. Any equitable adjustments will be made as necessary to any affected conditions of the Contract.

Article 20 Default by the Contractor

- 20.01.01 If the Contractor is in default in carrying out any of its obligations under the Contract, the Contracting Authority may, by giving written notice to the Contractor, terminate for default the Contract or part of the Contract. The termination will take effect immediately or at the expiration of a cure period specified in the notice, if the Contractor has not cured the default to the satisfaction of the Contracting Authority within that cure period.
- 20.01.02 If the Contractor becomes bankrupt or insolvent, makes an assignment for the benefit of creditors, or takes the benefit of any statute relating to bankrupt or insolvent debtors, or if a receiver is appointed under a debt instrument or a receiving order is made against the Contractor, or an order is made or a resolution passed for the winding down of the Contractor, the Contracting Authority may, to the extent permitted by the laws of Canada, by giving written notice to the Contractor, immediately terminate for default the Contract or part of the Contract.
- 20.01.03 If Elections Canada gives notice under Subsection 20.01.01 or 20.01.02, the Contractor will have no claim for further payment except as provided in this Section. The Contractor will be liable to Elections Canada for all losses and damages suffered by Elections Canada because of the default or occurrence upon which the notice was based, including any increase in the cost incurred by Elections Canada in procuring the Work from another source. The Contractor agrees to repay immediately to Elections Canada the portion of any advance payment that is unliquidated at the date of the termination.
- 20.01.04 Upon termination of the Contract under this Section, the Contracting Authority may require the Contractor to deliver to Elections Canada, in the manner and to the extent directed by the Contracting Authority, any completed parts of the Work, not delivered and accepted before the termination and anything the Contractor has acquired or produced specifically to perform the Contract. In such a case, subject to the deduction of any claim that Elections Canada may have against the Contractor arising under the Contract or out of the termination, Elections Canada will pay or credit to the Contractor:
- (a) the value, of all completed parts of the Work delivered to and accepted by Elections Canada, based on the Contract Price, including the proportionate part of the Contractor's profit or fee included in the Contract Price; and
 - (b) the cost to the Contractor that Elections Canada considers reasonable in respect of anything else delivered to and accepted by Elections Canada.
- 20.01.05 The total amount paid by Elections Canada under the Contract to the date of the

termination and any amount payable under this Subsection must not exceed the Contract Price.

- 20.01.06 Title to everything for which payment is made to the Contractor will, once payment is made, pass to Elections Canada unless it already belongs to Elections Canada under any other provision of the Contract.
- 20.01.07 If the Contract is terminated for default under Subsection 20.01.01, but it is later determined that grounds did not exist for a termination for default, the notice will be considered a notice of termination for convenience issued under Subsection 21.01.01

Article 21 Termination for Convenience

- 21.01.01 At any time before the completion of the Work, the Contracting Authority may, by giving notice in writing to the Contractor, terminate for convenience the Contract or part of the Contract. Once such a notice of termination for convenience is given, the Contractor must comply with the requirements of the termination notice. If the Contract is terminated in part only, the Contractor must proceed to complete any part of the Work that is not affected by the termination notice. The termination will take effect immediately or, as the case may be, at the time specified in the termination notice.
- 21.01.02 If a termination notice is given pursuant to Subsection 21.01.01, the Contractor will be entitled to be paid, for costs that have been reasonably and properly incurred to perform the Contract to the extent that the Contractor has not already been paid or reimbursed by Elections Canada. The Contractor will be paid:
- (a) on the basis of the Contract Price, for all completed Work that is inspected and accepted in accordance with the Contract, whether completed before, or after the termination in accordance with the instructions contained in the termination notice;
 - (b) the Cost to the Contractor plus a fair and reasonable profit for all work terminated by the termination notice before completion; and
 - (c) all costs incidental to the termination of the Work incurred by the Contractor but not including the cost of severance payments or damages to employees whose services are no longer required, except wages that the Contractor is obligated by statute to pay.

Elections Canada may reduce the payment in respect of any part of the Work, if upon inspection; it does not meet the requirements of the Contract.

- 21.01.03 The total of the amounts, to which the Contractor is entitled to be paid under this Section, together with any amounts paid, due or becoming due to the Contractor must not exceed the Contract Price. The Contractor will have no claim for damages, compensation, loss of profit, allowance arising out of any termination notice given by Elections Canada under this Section except to the extent that this Section expressly provides. The Contractor agrees to

repay immediately to Elections Canada the portion of any advance payment that is unliquidated at the date of the termination.

Article 22 Assignment

- 22.01.01 The Contractor must not assign the Contract without first obtaining the written consent of the Contracting Authority. Any assignment made without that consent is void and will have no effect. The assignment will be effective upon execution of an assignment agreement signed by the Parties and the assignee.
- 22.01.02 Assignment of the Contract does not relieve the Contractor from any obligation under the Contract and it does not impose any liability upon Elections Canada.

Article 23 Right of Set-Off

Without restricting any right of set-off given by law, Elections Canada may set-off against any amount payable to the Contractor under the Contract, any amount payable to Elections Canada by the Contractor under the Contract or under any other current contract. Elections Canada may, when making a payment pursuant to the Contract, deduct from the amount payable to the Contractor any such amount payable to Elections Canada by the Contractor which, by virtue of the right of set-off, may be retained by Elections Canada.

Article 24 Amendments and Waivers

Section 24.01 Amendment

- 24.01.01 To be effective, any amendment to the Contract must be done in writing by the Contracting Authority and the authorized representative of the Contractor.
- 24.01.02 While the Contractor may discuss any proposed modifications to the Work with other representatives of Elections Canada, Elections Canada will not be responsible for the cost of any modification unless it has been incorporated into the Contract in accordance with Subsection 24.01.01.

Section 24.02 Waiver

- 24.02.01 A waiver will only be valid, binding or affect the rights of the Parties if it is made in writing by, in the case of a waiver by Elections Canada, the Contracting Authority and, in the case of a waiver by the Contractor, the authorized representative of the Contractor.
- 24.02.02 The waiver by a Party of a breach of any condition of the Contract will not be treated or interpreted as a waiver of any subsequent breach and therefore will not prevent it from enforcing that term or condition in the case of a subsequent breach.

Article 25 Codes

Section 25.01 Conflict of Interest and Values and Ethics Codes for the Public Sector

The Contractor acknowledges that individuals who are subject to the provisions of the *Conflict of Interest Act*, 2006, c. 9, s. 2, the Conflict of Interest Code for Members of the House of Commons, the Values and Ethics Code for the Public Sector or all other codes of values and ethics applicable within specific organizations cannot derive any direct benefit resulting from the Contract.

Section 25.02 Code of Conduct for Procurement

The Contractor certifies that it has read the Code of Conduct for Procurement (<http://www.tpsgc-pwgsc.gc.ca>) and agrees to be bound by its terms.

Article 26 No Bribe or Conflict

Section 26.01 No Bribe

The Contractor declares that no bribe, gift, benefit, or other inducement has been or will be paid, given, promised or offered directly or indirectly to any official or employee of Elections Canada or to a member of the family of such a person, with a view to influencing the entry into the Contract or the administration of the Contract.

Section 26.02 No Conflict of Interest

- 26.02.01 The Contractor must not influence, seek to influence or otherwise take part in a decision of Elections Canada knowing that the decision might further its private interest. The Contractor must have no financial interest in the business of a third party that causes or would appear to cause a conflict of interest in connection with the performance of its obligations under the Contract. If such a financial interest is acquired during the period of the Contract, the Contractor must immediately declare it to the Contracting Authority.
- 26.02.02 The Contractor warrants that, to the best of its knowledge after making diligent inquiry, no conflict exists. In the event the Contractor becomes aware of any matter that causes or is likely to cause a conflict in relation to the Contractor's performance under the Contract, the Contractor must immediately disclose such matter to the Contracting Authority in writing.
- 26.02.03 If the Contracting Authority is of the opinion that a conflict exists as a result of the Contractor's disclosure or as a result of any other information brought to the Contracting Authority's attention, the Contracting Authority may require the Contractor to take steps to resolve or otherwise deal with the conflict or, at its entire discretion, terminate the Contract for default. Conflict means any matter, circumstance, interest, or activity affecting the Contractor, its personnel or subcontractors, which may or may appear to impair the ability of the Contractor to perform the Work diligently and independently.

Article 27 Contingency Fees

27.01.01 The Contractor certifies that it has not, directly or indirectly, paid or agreed to pay and agrees that it will not, directly or indirectly, pay a contingency fee for the solicitation, negotiation or obtaining of the Contract to any person, other than an employee of the Contractor acting in the normal course of the employee's duties.

27.01.02 In this Section

(a) "contingency fee" means any payment or other compensation that depends or is calculated based on a degree of success in soliciting, negotiating or obtaining the Contract; and

(b) "person" includes any individual who is required to file a return with the registrar pursuant to Section 5 of the *Lobbying Act*, 1985, c. 44 (4th Supplement).

Article 28 International Sanctions

28.01.01 Persons in Canada, and Canadians outside of Canada, are bound by economic sanctions imposed by Canada. As a result, Elections Canada cannot accept delivery of goods or services that originate, either directly or indirectly, from the countries or persons subject to economic sanctions.

28.01.02 The Contractor must not supply to Elections Canada any goods or services which are subject to economic sanctions.

28.01.03 The Contractor must comply with changes to the regulations imposed during the period of the Contract. The Contractor must immediately advise Elections Canada if it is unable to perform the Work as a result of the imposition of economic sanctions against a country or person or the addition of a good or service to the list of sanctioned goods or services. If the Parties cannot agree on a work around plan, the Contract will be terminated for the convenience of Elections Canada in accordance with Article 21 (Termination for Convenience).

Article 29 Notice

Any notice under the Contract must be in writing and may be delivered by hand, courier, mail, facsimile or other electronic method that provides a paper record of the text of the notice. It must be sent to the Party for whom it is intended at the address stated in the Contract or to such other address, from time to time designated in writing. Any notice will be effective on the day it is received at that address. Any notice to Elections Canada must be delivered to the Contracting Authority.

Article 30 Survival

All the Parties' obligations of confidentiality, representations and warranties set out in the Contract as well as the provisions, which by the nature of the rights or obligations might reasonably be expected to survive, will survive the expiry or termination of the Contract.

Article 31 Governing Law

Section 31.01 Compliance with Applicable Laws

- 31.01.01 The Contractor must comply with all laws applicable to the performance of the Contract. The Contractor must provide evidence of compliance with such laws to Canada at such times as Elections Canada may reasonably request.
- 31.01.02 The Contractor must obtain and maintain at its own cost all permits, licenses, regulatory approvals and certificates required to perform the Work. If requested by the Contracting Authority, the Contractor must provide a copy of any required permit, license, regulatory approvals or certificate to Elections Canada.

Article 32 Successor and Assigns

The Contract is binding upon and enures to the benefit of Elections Canada and its successors and assigns and the Contractor and its successors and permitted assigns.

Part 7 - Mandatory Technical Evaluation Criteria

SECTION A – MANDATORY EVALUATION CRITERIA

The Proposal must clearly demonstrate that the Bidder meets the following Mandatory Criteria.

Mandatory Technical Criteria	Description	Bidder to Complete
<p>M1 - Compliance with Annex A - Specifications</p>	<p>Bidder acknowledges that they comply with all requirements of Annex A – Specifications - for the item(s) for which they are submitting a proposal.</p> <p>Failure to agree to the requirements identified in Annex A - Specifications - shall deem your proposal non-responsive and therefore shall not be given any further consideration in the evaluation process.</p>	<p>() Yes, I confirm that I will comply with all the requirements of Annex “A” Specifications for the item(s) for which I am submitting a proposal.</p> <p>() No, I cannot confirm that I will comply with all the requirements of Annex “A” Specifications for the item(s) for which I am submitting a proposal.</p>

Part 8 - Financial Evaluation Criteria

GROUP 1

FIRM UNIT PRICE

In the tables below the Bidder must quote a firm unit price for items as defined in the Annex A – Specifications. The firm unit prices quoted by the Bidder must be in Canadian dollars and exclude all Applicable Sales Tax.

Bidders can submit pricing for one or more of the items below.

1.0 INITIAL QUANTITY

Item #	Description	Unit of Measure	Quantity	Firm Unit Price	Firm Extended Price
1.	EC 50370 (08/2014) Envelope for White Copy of the Statement of the Votes	Singles	120,000		
2.	EC 50380 (08/2014) Envelope for yellow copy of the Statement of the Votes	Singles	120,000		
3.	EC 50400 (08/2014) Envelope for Daily Ballots Cast – Advance Poll	Sets of 4	12,000		
4.	EC50410 (08/2014) - Envelope for Mobile Poll Ballots Cast	Sets of 4	5,000		
5.	EC 50420 (08/2014) Envelope for Unused Ballot	Singles	110,000		
6.	EC 50420 (08/2014) Envelope for Unused Ballot	Sets of 4	5,500		
7.	EC 50421 (08/2014) Envelope – Record of Votes Cast and Unused Ballots for Advance Poll	Sets of 4	12,000		
8.	EC 50450 (08/2014) Envelope for Ballots Cast	Sets of 7	130,000		
	TOTAL COST – INITIAL QUANTITY				

2.0 OPTION 1 – 50% of the INITIAL QUANTITY

Item #	Description	Unit of Measure	Quantity	Firm Unit Price	Firm Extended Price
1.	EC 50370 (08/2014) Envelope for White Copy of the Statement of the Votes	Singles of 1	60,000		
2.	EC 50380 (08/2014) Envelope for yellow copy of the Statement of the Votes	Singles of 1	60,000		
3.	EC 50400 (08/2014) Envelope for Daily Ballots Cast – Advance Poll	Sets of 4	6,000		
4.	EC50410 (08/2014) - Envelope for Mobile Poll Ballots Cast	Sets of 4	2,500		
5.	EC 50420 (08/2014) Envelope for Unused Ballot	Singles of 1	55,000		
6.	EC 50420 (08/2014) Envelope for Unused Ballot	Sets of 4	2,750		
7.	EC 50421 (08/2014) Envelope – Record of Votes Cast and Unused Ballots for Advance Poll	Sets of 4	6,000		
8.	EC 50450 (08/2014) Envelope for Ballots Cast	Sets of 7	65,000		
TOTAL COST – OPTION 1					

3.0 OPTION 2 – 100% of the INITIAL QUANTITY

Item #	Description	Unit of Measure	Quantity	Firm Unit Price	Firm Extended Price
1.	EC 50370 (08/2014) Envelope for White Copy of the Statement of the Votes	Singles of 1	120,000		
2.	EC 50380 (08/2014) Envelope for yellow copy of the Statement of the Votes	Singles of 1	120,000		
3.	EC 50400 (08/2014) Envelope for Daily Ballots Cast – Advance Poll	Sets of 4	12,000		
4.	EC50410 (08/2014) - Envelope for Mobile Poll Ballots Cast	Sets of 4	5,000		
5.	EC 50420 (08/2014) Envelope for	Singles of 1	110,000		

	Unused Ballot				
6.	EC 50420 (08/2014) Envelope for Unused Ballot	Sets of 4	5,500		
7.	EC 50421 (08/2014) Envelope – Record of Votes Cast and Unused Ballots for Advance Poll	Sets of 4	12,000		
8.	EC 50450 (08/2014) Envelope for Ballots Cast	Sets of 7	130,000		
	TOTAL COST – OPTION 2				

Total evaluated cost equals the sum of the initial quantity plus options one and two

\$ _____

Part 8 - Financial Evaluation Criteria

GROUP 2

FIRM UNIT PRICE

In the tables below the Bidder must quote a firm unit price for items as defined in the Annex A – Specifications. The firm unit prices quoted by the Bidder must be in Canadian dollars and exclude all Applicable Sales Tax.

Bidders can submit pricing for one or more of the items below.

1.0 INITIAL QUANTITY

Item #	Description	Unit of Measure	Quantity	Firm Unit Price	Firm Extended Price
1.	EC 50385 (08/2014) Envelope for EC 50111	Single of 1	116,000		
2.	EC 50390 (08/2014) Registration and/or Correction Certificates	Single of 1	140,000		
3.	EC 50390 (08/2014) Registration and/or Correction Certificates	Sets of 4	22,000		
4.	EC 50422 (08/2014) Oath of Residence Envelope	Single of 1	113,000		
5.	EC 50422 (08/2014) Oath of Residence Envelope	Sets of 4	11,000		
6.	EC 50423 (08/2014) Candidates' Rep Authorization/Sign-in Envelope	Single of 1	49,000		
7.	EC 50430 (08/2014) Envelope for Spoiled Ballot Papers	Sets of 4	110,000		
8.	EC 50430 (08/2014) Envelope for Spoiled Ballot Papers	Single of 1	5,000		
9.	EC 50431 (08/2014) Envelope for Spoiled ballot paper – Advance Poll	Sets of 4	12,000		
10.	EC 50440 (08/2014) Envelope for Rejected Ballots	Single of 1	130,000		
11.	EC 50460 (08/2014) Document Envelope Cast	Single of 1	150,000		
TOTAL COST – INITIAL QUANTITY					

2.0 OPTION 1 – 50% of the INITIAL QUANTITY

Item #	Description	Unit of Measure	Quantity	Firm Unit Price	Firm Extended Price
1.	EC 50385 (08/2014) Envelope for EC 50111	Single of 1	58,000		
2.	EC 50390 (08/2014) Registration and/or Correction Certificates	Single of 1	70,000		
3.	EC 50390 (08/2014) Registration and/or Correction Certificates	Sets of 4	11,000		
4.	EC 50422 (08/2014) Oath of Residence Envelope	Single of 1	56,500		
5.	EC 50422 (08/2014) Oath of Residence Envelope	Sets of 4	5,500		
6.	EC 50423 (08/2014) Candidates' Rep Authorization/Sign-in Envelope	Single of 1	24,500		
7.	EC 50430 (08/2014) Envelope for Spoiled Ballot Papers	Sets of 4	55,000		
8.	EC 50430 (08/2014) Envelope for Spoiled Ballot Papers	Single of 1	2,500		
9.	EC 50431 (08/2014) Envelope for Spoiled ballot paper – Advance Poll	Sets of 4	6,000		
10.	EC 50440 (08/2014) Envelope for Rejected Ballots	Single of 1	65,000		
11.	EC 50460 (08/2014) Document Envelope Cast	Single of 1	75,000		
TOTAL COST – OPTION1					

3.0 OPTION 2 – 100% of the INITIAL QUANTITY

Item #	Description	Unit of Measure	Quantity	Firm Unit Price	Firm Extended Price
1.	EC 50385 (08/2014) Envelope for EC 50111	Single of 1	116,000		
2.	EC 50390 (08/2014) Registration and/or Correction Certificates	Single of 1	140,000		

3.	EC 50390 (08/2014) Registration and/or Correction Certificates	Sets of 4	22,000		
4.	EC 50422 (08/2014) Oath of Residence Envelope	Single of 1	113,000		
5.	EC 50422 (08/2014) Oath of Residence Envelope	Sets of 4	11,000		
6.	EC 50423 (08/2014) Candidates' Rep Authorization/Sign-in Envelope	Single of 1	49,000		
7.	EC 50430 (08/2014) Envelope for Spoiled Ballot Papers	Sets of 4	110,000		
8.	EC 50430 (08/2014) Envelope for Spoiled Ballot Papers	Single of 1	5,000		
9.	EC 50431 (08/2014) Envelope for Spoiled ballot paper – Advance Poll	Sets of 4	12,000		
10.	EC 50440 (08/2014) Envelope for Rejected Ballots	Single of 1	130,000		
11.	EC 50460 (08/2014) Document Envelope Cast	Single of 1	150,000		
	TOTAL COST – OPTION 2				

Total Evaluated Cost equals the sum of the Initial Quantity plus Options 1 and 2 –

\$ _____



Printing of Various Envelopes

PART 9

Certificates

Certificates

1. Independent Proposal

1.1. I, the undersigned, on behalf of _____ [insert name of Bidder] (the “Bidder”) in submitting the accompanying proposal (the “proposal”) to Elections Canada for the [Insert name of requirement] hereby make the following statements, that I certify to be true and complete in every respect:

- (a) I have read and I understand the contents of this Certificate;
- (b) I understand that the proposal will be disqualified if this Certificate is found not to be true and complete in every respect;
- (c) I am authorized by the Bidder to sign this Certificate, and to submit the proposal, on behalf of the Bidder;
- (d) each person whose signature appears on the proposal has been authorized by the Bidder to determine the terms of, and to sign, the proposal, on behalf of the Bidder;
- (e) for the purpose of this Certificate and the proposal. I understand that the word “competitor” shall include any individual or organization, other than the Bidder, whether or not an Affiliate of the Bidder, who:
 - i. has been requested to submit a proposal in response to the request for proposal;
 - ii. could potentially submit a proposal in response to the request for proposal, based on their qualification, abilities or experience;
- (f) the Bidder disclosed that (check one of the following, as applicable):

- i. the Bidder has arrived at the proposal independently from, and without consultation, communication, agreement or arrangement with, any competitor;

OR

- ii. the Bidder has entered into consultations, communications, agreements or arrangements with one or more competitors regarding this call for proposals, and the Bidder disclosed, in the attached documents (s) complete details thereof, including the names of the competitors and the nature of, and reasons for, such consultation, communications, agreements or arrangements.

- (g) in particular, without limiting the generality of subparagraphs (f)i. or (f)ii. above, there has been no consultation, communications, agreement or arrangement with any competitor regarding:

- i. prices
 - ii. methods, factors or formulas used to calculate prices;
 - iii. the intention or decisions to submit, or not to submit, a proposal; or
 - iv. the submission of a proposal which does not meet the specifications of the call for proposals;
- except as specifically disclosed pursuant to subparagraph (f)ii. above:

- (h) in addition, there has been no consultation, communications, agreement or arrangement with any competitor regarding the quality, quantity, specifications or delivery particulars of the products or services to which this call for proposals relates, except as specially authorized by the Contracting Authority or as specifically disclosed pursuant to subparagraph (f)ii. above;
- (i) the terms of the proposal have not been, and will not be, knowingly disclosed by the Bidder, directly or indirectly, to any competitor, prior to the date and time of the official proposal opening, or of the awarding of the contract, whichever comes first, unless otherwise required by law or as specially disclosed pursuant to subparagraph (f)ii. above.

2. General

- 2.1. This certification shall be true and correct throughout the term of the Contract with the same force and effect as if continuously made throughout the term of the Contract.
- 2.2. Furthermore, the Bidder acknowledges that Elections Canada shall rely on this certification to award the Contract. Should the Bidder fail to comply with this certification or in the event that verification or inspection by Elections Canada discloses a misrepresentation on the part of the Bidder, Elections Canada shall have the right to treat any contract resulting from this proposal as being in default and to terminate it pursuant to the default provisions of the Contract.

Signature of the Authorized Representative of Bidder

Date

Print Name of Authorized Representative of Bidder:

Print Title of Authorized Representative of Bidder:
