



**REQUEST FOR PROPOSALS
DEMANDE DE PROPOSITIONS**

**RETURN BIDS TO :
RETOURNER LES
SOUMISSIONS À:**

National Research Council Canada (NRC)
Procurement Services
1200 Montreal Road, Building M-22
Ottawa, Ontario
K1A 0R6
Bid Fax: (613) 991-3297

Title/Sujet Modular Acoustic Enclosure /Supply and Install	
Solicitation No./N. de l'invitation 14-22087	Date November 24, 2014
Solicitation Closes/L'invitation prend fin at/à 14 :00 on/le January 5th 2014	Time Zone/Fuseau Horaire EDT
Address Enquiries To/Adresser demandes de renseignements à : Johnathon Gillis Telephone No./N. de téléphone : (613)993-5506 Facsimile No./N. de télécopieur : (613) 998-5701	

Instructions: See Herein

Instructions: Voir aux présentes

Proposal To:

We hereby offer to sell to Her Majesty the Queen in right of Canada, in accordance with the terms and conditions set out herein, referred to herein or attached hereto, the goods, services, and construction listed herein and on any attached sheets at the price(s) set out therefor.

Proposition aux:

Nous offrons par la présente de vendre à Sa Majesté la Reine du chef du Canada, aux conditions énoncées ou incluses par référence dans la présente et aux annexes ci-jointes, les biens, services et construction énumérés ici sur toute feuille ci-annexée, au(x) prix indiqué(s).



Vendor/Firm Name and Address Raison sociale et adresse du fournisseur/de l'entrepreneur	
Telephone No./N. de telephone Facsimile No./N. de télécopieur	
Name and title of person authorized to sign on behalf of Vendor/Firm (type or print) Nom et titre de la personne autorisé à signer au nom du fournisseur/de l'entrepreneur (taper ou écrire en caractères d'imprimerie)	
Signature	Date

Modular Acoustic Enclosure /Supply and Install

1.0 PRESENTATION OF PROPOSALS

- 1.1 You are invited to submit four copies of a Technical Proposal and two copies of a Financial Proposal in two separate envelopes to fulfil the following requirement forming part of this Request for Proposals. One envelope **must** be clearly marked 'Technical Proposal' and the other envelope **must** be marked 'Financial Proposal'. All financial information **must** be fully contained in the Financial Proposal, and only in the Financial Proposal. Vendors who provide financial information in the technical proposal will be disqualified. **All proposals should include the front page of this RFP duly completed.**

2.0 SCOPE OF WORK

- 2.1 To provide Professional Services for the National Research Council in accordance with the detailed Statement of Work attached as Appendix "A".

3.0 PERIOD OF CONTRACT

- 3.1 NRC anticipates that the work will begin on **January 11 2014** and be completed by **March 31, 2014**.

4.0 ENQUIRIES

- 4.1 If you require clarification regarding any aspect of this RFP, address all queries to the Contracting Authority, identified below, at least 5 working days before the closing date. All queries must be in writing and queries received less than 5 working days prior to the closing date cannot be guaranteed a response. Information received verbally will not be binding upon the NRC.

Johnathon Gillis

Contracting Authority, Procurement Services

National Research Council Canada

1200 Montreal Road, Bldg. M-22

Ottawa, Ontario K1A 0R6

Telephone: **(613) 993-5506**

Facsimile: **(613) 998-5701**

- 4.2 To ensure the equality of information among Bidders, responses to general enquiries will be made available to all bidders unless such publications would reveal proprietary information. The bidder who initiates the question will not be identified. Technical questions that are considered proprietary by the bidder must be clearly identified. NRC will respond individually to the bidder if it considers the questions proprietary. If NRC does not consider the question proprietary, the bidder submitting it will be allowed to withdraw the question, or have the question and answer made available through the Open Bidding System (OBS) to all bidders.
- 4.3 Vendors who attempt to obtain information regarding any aspect of this RFP during the solicitation period through any NRC contacts other than the Contracting Authority identified herein, may be disqualified (for that reason alone).
- 4.4 It is the responsibility of the Bidder to obtain clarification of the requirement contained herein, if necessary, prior to submitting its proposal. The Bidder must have written confirmation from the Contracting Authority for any changes, alterations, etc., concerning this RFP.

5.0 **PROPOSAL CLOSING DATE AND BID SUBMISSION INSTRUCTIONS**

5.1 Proposals must be delivered not later than 2:00 PM EST, (day), **11 January 2014**, to the following **Contracting Authority**:

Johnathon Gillis

Contracting Authority, Procurement Services
National Research Council Canada
1200 Montreal Road, Bldg. M-22
Ottawa, Ontario K1A 0R6 Telephone: (613) 993-5506

Proposals must not be sent directly to the Project Authority

- 5.2 Proposals must be delivered in a sealed envelope and the Bidder's name and the RFP No. should be clearly indicated on the Proposal Envelope. It is the vendor's responsibility to obtain date and time stamped receipt signed by the receptionist as proof that NRC has received their proposal within the prescribed time limit. All risks and consequences of incorrect delivery of bids are the responsibility of the Bidder.
- 5.3 Bid submissions must be in accordance with the Standard Instructions and Conditions (Applicable to Bid Solicitation) attached as Appendix "B".
- 5.4 Due to the nature of this solicitation, NRC will not accept any proposal documents by facsimile.
- 5.5 NRC will not accept any proposal documents by electronic mail or on diskette.
- 5.6 Proposals received after the closing date will not be considered and will be returned to the sender. The sender has the sole responsibility for the timely dispatch and delivery of a proposal and cannot transfer such responsibility to the NRC. No supplementary information will be accepted after the closing deadline unless NRC requests a clarification.
- 5.7 All submitted proposals become the property NRC and will not be returned to the originator.

6.0 **EVALUATION CRITERIA**

- 6.1 Proposals will be assessed and verified by NRC technical authorities /evaluation committee. Suppliers must meet the mandatory requirements in the Statement of work and be deemed compliant in each section of the evaluation grid – Appendix C in order to be considered technically compliant. NRC reserves the right to verify any and all information provided by the bidder in his/her proposal.

*****Vendors must cross reference the mandatory technical criteria in a concise format by using page, paragraph(s) & sub-paragraphs as applicable to their supporting technical documentation.*****

7.0 COST PROPOSAL

- 7.1 The cost proposal must be a **fixed price quotation, FOB Destination, excluding GST/HST**. The fixed price must include all the materials and services required to fulfil all aspects of the Statement of Work. Bidders should identify the currency on which the cost proposal is based.

It is anticipated that the work will take place in the National Capital Region (NCR). The per diem rates (**or fixed price quotation**) must include all costs required to perform the work, including Travel and Living Costs incurred in performing the services. Where NRC directs the Contractor to work outside the National Capital Region, the Contractor shall be paid for preauthorised reasonable and proper travel and living expenses supported by appropriate receipts. In this case, Travel and Living Costs will be in addition to the per diem rates (**or fixed price quotation**).

- 7.2 The cost proposal must have sufficient structure to show how the total proposed cost was calculated. It should contain the following elements:
- a) The number, classification and per diem and/or hourly rate for all assigned personnel. For each classification, the number of workdays should be defined.
 - b) The amount and explanation for other miscellaneous expenses that could be incurred.
 - c) The Contractor will be reimbursed its authorized travel and living expenses reasonably and properly incurred in the performance of the Work, at cost, without any allowance for profit and/or administrative overhead, in accordance with the meal, private vehicle and incidental expenses provided in Appendices B, C and D of the Treasury Board Travel Directive, and with the other provisions of the directive referring to "travellers", rather than those referring to "employees".
- 7.3 **GOODS AND SERVICES TAX (GST) and HARMONIZED SALES TAX (HST):** The GST and HST, whichever is applicable, shall be considered an applicable tax for the purposes of this RFP and extra to the price herein. The amount of GST or HST shall be disclosed and shown as a separate item.
- 7.4 Bids will be evaluated in Canadian currency, therefore, for evaluation purposes, the exchange rate quoted by the Bank of Canada as being in effect on date of bid closing, shall be applied as the conversion factor for foreign currency. Prices quoted shall not be subject to, or conditional upon, fluctuations in commercial or other interest rates during either the evaluation or contract period.

8.0 CONDITIONS OF SUBMISSION

- 8.1 There shall be no payment by the National Research Council for costs incurred in the preparation and submission of proposals in response to this request. No payment shall be made for costs incurred for clarification(s) and/or demonstration(s) that may be required by NRC. The National Research Council reserves the right to reject any or all proposals submitted, or to accept any proposal in whole or in part without negotiation. A contract will not necessarily be issued as a result of this competition. NRC reserves the right to amend, cancel or reissue this requirement at any time.

- 8.2 The method of selection will be the valid proposal with the lowest financial proposal.
- 8.3 Proposals submitted must be valid for not less than sixty (60) calendar days from the closing date of the RFP.
- 8.4 Your proposal should contain the following statement:
"We hereby certify that the price quote is not in excess of the lowest price charged anyone else, including our most favoured customer, for like services".
- 8.5 Any contract resulting from this invitation will be subject to the General Conditions - **Services 2035 (copy attached as Appendix "D")** and any other special conditions that may apply.

9.0 CONFIDENTIALITY

9.1 This document is UNCLASSIFIED, however; the contractor shall treat as confidential, during as well as after the services contracted for, any information of the affairs of NRC of a confidential nature to which its servants or agents become privy.

10.0 CRIMINAL CODE OF CANADA

10.1 Canada may reject an offer where the Bidder, or any employee or subcontractor included as part of the offer, has been convicted under section 121 ("Frauds on the government" & Contractor subscribing to election fund"), 124 ("Selling or purchasing office"), or 418 ("Selling defective stores to Her Majesty") of the Criminal Code.

11.0 DEBRIEFINGS

11.1 After contract award, bidders may request a debriefing on the results of the bid solicitation. Bidders should make the request to the Contracting Authority within 15 working days of receipt of notification that their bid was unsuccessful. The debriefing may be provided in writing, by telephone or in person.

12.0 GOVERNMENT SMOKING POLICY

12.1 Where the performance of the work requires the presence of the Contractor's personnel on government premises, the Contractor shall ensure that its personnel shall comply with the policy of the Government of Canada, which prohibits smoking on any government premises.

13.0 ACCESS TO GOVERNMENT FACILITIES / EQUIPMENT

13.1 Access to the facilities and equipment necessary to the performance of the work shall be provided through arrangements to be made by the Project Authority named herein. There will be however; no day-to-day supervision of the Contractor's activities nor control of the Contractor's hours of work by the Project Authority.

13.2 The Contractor undertakes and agrees to comply with all Standing Orders and Regulations in force on the site where the work is to be performed, relating to the safety of

persons on the site or the protection of property against loss or damage from any and all causes including fires.

14.0 **GENERAL CONDITIONS**

14.1 The General Conditions 2035 entitled General Conditions Services and attached as Appendix "D" form part of this Contract.

15.0 **PROGRESS REPORT**

15.1 As part of and together with each progress claim, the Contractor must submit a progress report consisting of a narrative of approximately one (1) page describing the technical progress achieved in terms of the "Statement of Work", explaining any variations in the work or expenditure plan, specifying any problems encountered or foreseen (relating to time, cost or technical matters) and any other matter considered reportable by the Contractor.

16.0 **ADDITIONAL WORK**

16.1 The successful bidder can at NRC's option, be asked to provide additional work related to this requirement. Payment will be limited to the firm per diems quoted in the Contractor's proposal.

17.0 **NON-PERMANENT RESIDENT (FOREIGN COMPANY)**

17.1 The Contractor shall ensure that non-permanent residents intending to work in Canada on a temporary basis in fulfillment of the Contract, who are neither Canadian citizens nor United States nationals, receive all appropriate documents and instructions relating to Canadian immigration requirements and secure all required employment authorizations prior to their arrival at the Canadian port of entry. The Contractor shall ensure that United States nationals having such intentions receive all appropriate documents and instructions in that regard prior to their arrival at the Canadian port of entry. Such documents may be obtained at the appropriate Canadian Embassy/Consulate in the Contractor's country. The Contractor shall be responsible for all costs incurred as a result of non-compliance with immigration requirements.

18.0 **NON-PERMANENT RESIDENT (CANADIAN COMPANY)**

18.1 The Contractor is responsible for compliance with the immigration requirements applicable to non-permanent residents entering Canada to work on a temporary basis in fulfillment of the Contract. In some instances, the employment authorization necessary to enter Canada cannot be issued without prior approval of Human Resources Centre Canada (HRCC). HRCC should always be contacted as soon as the decision to bring in a non-permanent resident is made. The Contractor will be responsible for all costs incurred as a result of non-compliance with immigration requirements.

19.0 **LUMP SUM PAYMENT - WORK FORCE REDUCTION PROGRAMS**

19.1 It is a term of the contract that:

- a. the Contractor has declared to the Departmental Representative whether the Contractor has received a lump sum payment made pursuant to any work force reduction program, including but not limited to the Work Force Adjustment Directive, the Early Departure Incentive Program, the Early Retirement Incentive Program or the Executive Employment Transition Program, which has been implemented to reduce the public service;
- b. the Contractor has informed the Departmental Representative of the terms and conditions of that work force reduction program, pursuant to which the Contractor was made a lump sum payment, including the termination date, the amount of the lump sum payment and the rate of pay on which the lump sum payment was based; and
- c. the Contractor had informed the Departmental Representative of any exemption in respect of the abatement of a contract fee received by the Contractor under the Early Departure Incentive Program Order or paragraph 4 of Policy Notice 1995-8, of July 28, 1995.

20.0 **FORMER PUBLIC SERVANT**

20.1 Contracts with former public servants (FPS) in receipt of a pension or of a lump sum payment must bear the closest public scrutiny, and reflect fairness in the spending of public funds. In order to comply with Treasury Board policies and directives on contracts with FPS, bidders must provide the information required below.

20.2 Definitions

For the purposes of this clause,

"former public servant" is any former member of a department as defined in the Financial Administration Act, R.S., 1985, c. F-11, a former member of the Canadian Armed Forces or a former member of the Royal Canadian Mounted Police. A former public servant may be:

- a) an individual;
- b) an individual who has incorporated;
- c) a partnership made of former public servants; or
- d) a sole proprietorship or entity where the affected individual has a controlling or major interest in the entity.

"lump sum payment period" means the period measured in weeks of salary, for which payment has been made to facilitate the transition to retirement or to other employment as a result of the implementation of various programs to reduce the size of the Public Service. The lump sum payment period does not include the period of severance pay, which is measured in a like manner.

"pension" means, a pension or annual allowance paid under the Public Service Superannuation Act (PSSA), R.S., 1985, c.P-36, and any increases paid pursuant to the Supplementary Retirement Benefits Act, R.S., 1985, c.S-24 as it affects the PSSA. It does

not include pensions payable pursuant to the Canadian Forces Superannuation Act, R.S., 1985, c.C-17, the Defence Services Pension Continuation Act, 1970, c.D-3, the Royal Canadian Mounted Police Pension Continuation Act, 1970, c.R-10, and the Royal Canadian Mounted Police Superannuation Act, R.S., 1985, c.R-11, the Members of Parliament Retiring Allowances Act, R.S., 1985, c.M-5, and that portion of pension payable to the Canada Pension Plan Act, R.S., 1985, c.C-8.

20.3 Former Public Servant in Receipt of a Pension

As per the above definitions, is the Bidder a FPS in receipt of a pension? **Yes () No ()**

If so, the Bidder must provide the following information, for all FPS in receipt of a pension, as applicable:

- a) name of former public servant;
- b) date of termination of employment or retirement from the Public Service.

20.4 By providing this information, Bidders agree that the successful Bidder's status, with respect to being a former public servant in receipt of a pension, will be reported on departmental websites as part of the published proactive disclosure reports in accordance with Contracting Policy Notice: 2012-2 and the Guidelines on the Proactive Disclosure of Contracts.

20.5 Work Force Reduction Program

Is the Bidder a FPS who received a lump sum payment pursuant to the terms of a work force reduction program? **Yes () No ()**

If so, the Bidder must provide the following information:

- a) name of former public servant;
- b) conditions of the lump sum payment incentive;
- c) date of termination of employment;
- d) amount of lump sum payment;
- e) rate of pay on which lump sum payment is based;
- f) period of lump sum payment including start date, end date and number of weeks;
- g) number and amount (professional fees) of other contracts subject to the restrictions of a work force reduction program.

20.6 For all contracts awarded during the lump sum payment period, the total amount of fees that may be paid to a FPS who received a lump sum payment is \$5,000, including the Goods and Services Tax or Harmonized Sales Tax.

21.0 **FORMER PUBLIC SERVANT**

21.1 Contracts with former public servants (FPS) in receipt of a pension or of a lump sum payment must bear the closest public scrutiny and reflect fairness in the spending of public funds. In order to comply with Treasury Board policies and directives on contracts with FPS, bidders must provide the information required below.

21.2 Definitions

For the purposes of this clause,

"former public servant" is any former member of a department as defined in the Financial Administration Act, R.S., 1985, c. F-11, a former member of the Canadian Armed Forces or a former member of the Royal Canadian Mounted Police. A former public servant may be:

- a) an individual;
- b) an individual who has incorporated;
- c) a partnership made of former public servants; or
- d) a sole proprietorship or entity where the affected individual has a controlling or major interest in the entity.

"lump sum payment period" means the period measured in weeks of salary, for which payment has been made to facilitate the transition to retirement or to other employment as a result of the implementation of various programs to reduce the size of the Public Service. The lump sum payment period does not include the period of severance pay, which is measured in a like manner.

"pension" means, in the context of the fee abatement formula, a pension or annual allowance paid under the Public Service Superannuation Act (PSSA), R.S., 1985, c. P-36, and any increases paid pursuant to the Supplementary Retirement Benefits Act, R.S., 1985, c. S-24 as it affects the PSSA. It does not include pensions payable pursuant to the Canadian Forces Superannuation Act, R.S., 1985, c. C-17, the Defence Services Pension Continuation Act, 1970, c. D-3, the Royal Canadian Mounted Police Pension Continuation Act, 1970, c. R-10, and the Royal Canadian Mounted Police Superannuation Act, R.S., 1985, c. R-11, the Members of Parliament Retiring Allowances Act, R.S., 1985, c. M-5, and that portion of pension to the Canada Pension Plan Act, R.S., 1985, c. C-8.

21.3 Former Public Servant in Receipt of a Pension

As per the above definitions, is the Bidder a FPS in receipt of a pension? **Yes () No ()**

If so, the Bidder must provide the following information, for all FPS in receipt of a pension, as applicable:

- a) name of former public servant;
- b) date of termination of employment or retirement from the Public Service.

21.4 By providing this information, Bidders agree that the successful Bidder's status, with respect to being a former public servant in receipt of a pension, will be reported on departmental websites as part of the published proactive disclosure reports in accordance with Contracting Policy Notice: 2012-2 and the Guidelines on the Proactive Disclosure of Contracts.

21.5 A contract for the services of a FPS who has been retired for less than one year and who is in receipt of a pension as defined above is subject to a fee reduction (abatement formula) as required by Treasury Board Policy.

21.6 Work Force Reduction Program

Is the Bidder a FPS who received a lump sum payment pursuant to the terms of a work force reduction program? **Yes** () **No** ()

If so, the Bidder must provide the following information:

- a) name of former public servant;
- b) conditions of the lump sum payment incentive;
- c) date of termination of employment;
- d) amount of lump sum payment;
- e) rate of pay on which lump sum payment is based;
- f) period of lump sum payment including start date, end date and number of weeks;
- g) number and amount (professional fees) of other contracts subject to the restrictions of a work force reduction program.

21.7 For all contracts awarded during the lump sum payment period, the total amount of fees that may be paid to a FPS who received a lump sum payment is \$5,000, including the Goods and Services Tax or Harmonized Sales Tax.

22.0 OFFICE OF THE PROCUREMENT OMBUDSMAN (OPO)

22.1 The Office of the Procurement Ombudsman (OPO) was established by the Government of Canada to provide an independent avenue for suppliers to raise complaints regarding the award of contracts under \$25,000 for goods and under \$100,000 for services. You have the option of raising issues or concerns regarding the solicitation, or the award resulting from it, with the OPO by contacting them by telephone at 1-866-734-5169 or by e-mail at boa.opo@boa-opo.gc.ca. You can also obtain more information on the OPO services available to you at their website at www.opo-boa.gc.ca.

23.0 ATTACHMENTS

Appendix "A" - Detailed Statement of Work
 Appendix "B" – Standard Instructions and Conditions (Applicable to Bid Solicitation)
 Appendix "C" – Evaluation Criteria
 Appendix "D" - General Conditions 2035

National Research Council Canada – Aerodynamics Lab

**Statement of Work for
Modular Acoustic Enclosure for M46 Wind Tunnel**

Project Number: A1-005927
NRC Solicitation No: (RFP) #14-22087
NRC Contract No: TBD
Document Version #: -
Document Issue Date: 14 November 2014

Prepared By: Jay Marshall - Facilities Engineer, Montreal Road Facilities

Scope of Work Amendment Table

Amendment No.	Issued Date	Affected Sections	Description of Changes

Table of Contents

1. CONTACTS.....	4
2. OBJECTIVE.....	4
3. BACKGROUND.....	4
4. TERMINOLOGY.....	5
5. REFERENCE DRAWINGS.....	5
6. ABBREVIATIONS.....	6
7. REQUIREMENTS.....	6
ANNEX A MILESTONE MATRIX.....	18

1. CONTACTS

1.1 Jay Marshall (Project Manager): 613-809-0142

1.1.1 Contact for technical questions at any time and co-ordination of on-site activities

1.2 Johnathon Gillis (Contracts Officer): 613-993-5506

1.2.1 Contact for contractual questions.

2. OBJECTIVE

2.1 To reduce the breakout noise coming off the Gas Turbine Engine exhaust pipework at the M46 Wind Tunnel. This is to be done by enclosing the pipework in a Modular Acoustic Enclosure.

3. BACKGROUND

3.1 The NRC Montreal Road Campus in Ottawa requires a Modular Acoustic Enclosure to be installed at the M46 Wind Tunnel (See Figure 1). The purpose of the Modular Acoustic Enclosure is to reduce the breakout noise coming off the Gas Turbine Engine exhaust pipework shown in Figure 2.



Figure 1 - NRC Propulsion Wind Tunnel – acoustic enclosure illustrated in red.



Figure 2 – Exhaust Pipes

4. TERMINOLOGY

- 4.1 The term “Contract” is defined as the legal agreement associated with performing the scope of work herein.
- 4.2 The term “Contractor” is defined as the winning bidder of the tendering process associated with the scope of work herein.
- 4.3 The term “Enclosure” is defined as the Modular Acoustic Enclosure that consists mainly of a Modular Acoustic Panel Structure and a Ventilation System

5. REFERENCE DRAWINGS

Drawing Title	Drawing Number
General Arrangement, Enclosure Assembly	SP-M46-PWT-03-00200
Foundation Layout	SP-M46-PWT-03-00201

6. ABBREVIATIONS

"	Inch
°C	degrees Celcius
°F	degrees Fahrenheit
3P	3-Phase
ASTM	American Society of Testing Materials
ARO	after receipt of order
AWG	american wire gauge
cu.ft	cubic foot
db	decibels
ga	gauge, gage
hz	hertz
lb	pounds
NRC	National Research Council
OBC	Ontario Building Code
OSHA	Occupational Safety and Health Administration
PPE	Personal Protection Equipment
should	a recommendation
SSPC	The Society for Protective Coatings
vs.	versus
VAC	AC Voltage
will	a statement of intent

7. REQUIREMENTS

7.1 General

7.1.1 The requirements contained in this statement of work are intended to define an economical solution within the constraints of Enclosures currently available without excessive or special (expensive or long-lead time) modifications. All bidders are encouraged to submit questions, propose alternate solutions, or identify any unconventional (difficult to satisfy, expensive) requirements that may be found herein.

7.1.2 All bidder inquiries will be posted for all potential bidders to review. It should be noted that the identity of the inquiry Bidder will remain anonymous to all other bidders.

7.1.3 The scope of work includes:

7.1.3.1 Design, Fabrication and Shipment of one (1) Enclosure as per the requirements herein;

7.1.3.2 Installation of one (1) Enclosure as per the requirements herein;

7.1.3.3 Development and delivery of all operation and maintenance documents associated with the Enclosure.

7.2 Design Requirements

7.2.1 A general concept of the Enclosure is shown in the sketch in Figure 3. A more detailed overview of the concept general arrangement is shown in NRC drawing # SP-M46-PWT-03-00200.

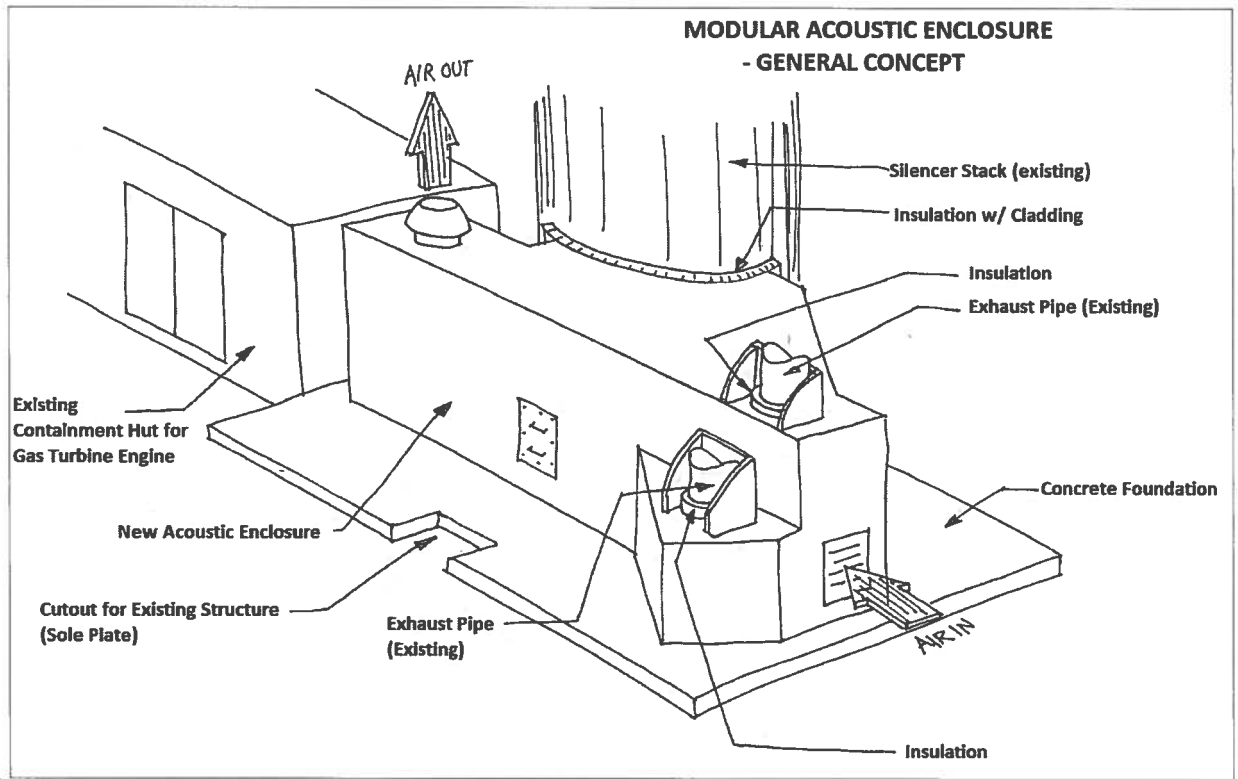

Figure 3 – Enclosure Concept Sketch.

7.2.2 Operating Conditions

7.2.2.1 The Enclosure will function and perform as specified herein when the ambient temperature is between -40°C and +40°C.

7.2.2.2 The Enclosure will function and perform as specified herein when subjected to typical year-round weather conditions that would be expected at the installation location.

7.2.3 Design Life

7.2.3.1 The Enclosure will have a 20 Year life without failure when operated and maintained as per the operation and maintenance instructions.

7.2.4 Performance Requirements – Ventilation

7.2.4.1 The Contractor will specify and install a ventilation system in the Enclosure to remove the heat generated by the exhaust pipework. The ventilation system will be designed to ensure that, under normal operating engine conditions, when the outside air temperature is 40°C [104°F], the overall temperature of the air inside the Enclosure does not exceed 60°C [140°F].

7.2.4.2 The Ventilation System will have silencers on both the intake and exhaust. The intake will be high enough off the ground such that loose grass, snow and/or any other debris is not ingested into the enclosure.

7.2.5 Performance Requirements – Acoustic

7.2.5.1 The acoustic panels will have minimum Sound Transmission Loss values vs. frequency as per Table 1. To demonstrate this, the Contractor will submit, at the bidding stage, results of a test performed in accordance with ASTM E90.

Frequency (Hz)	125	250	500	1k	2k	4k
T.L. (dB)	17	27	37	48	49	51

Table 1. Transmission Loss Requirements for Panel.

7.2.5.2 The acoustic panels will have minimum Sound Absorption Coefficient values vs. frequency as per Table 2. To demonstrate this, the Contractor will submit at the bidding stage, the results of a test performed in accordance with ASTM C423.

Frequency (Hz)	125	250	500	1k	2k	4k
Absorption Coefficient	0.7	0.75	1	1	0.95	0.9

Table 2. Absorption Coefficient Values for Panel.

7.2.5.3 The ventilation silencers (both intake and exhaust) will be designed to have minimum insertion loss values vs. frequency as per table 3.

Frequency (Hz)	63	125	250	500	1k	2k	4k	8k
I.L. (dB)	4	10	27	50	50	50	33	19

Table 3. Insertion Loss Values for Ventilation Silencers.

7.2.6 General Engineering Requirements

- 7.2.6.1 The Contractor will perform calculations demonstrating the structural integrity of the Enclosure and compliance with the Ontario Building Code (OBC) and any applicable local codes. This calculation will be delivered to NRC three weeks ARO.
- 7.2.6.2 The Contractor will perform calculations to determine the ventilation requirements and select a suitable ventilation system. The calculations will consider air resistance losses from the intake and exhaust silencers as well as insulation surface temperature. This calculation will be delivered to NRC two weeks ARO.
- 7.2.6.3 The Contractor will prepare Enclosure drawings to be reviewed and approved by NRC. These drawings will include the following:
 - 7.2.6.3.1 General Arrangement details such as the size of structural members, the details of the structural supports, typical panel construction, and the typical panel to panel and panel to facility structure connections. All drawings will accurately represent, in detail, the Enclosure which is to be supplied under the Contract. These details will be delivered to NRC four weeks ARO.

7.3 Fabrication Requirements

- 7.3.1 The Contractor will ensure that structural frames, if any, will be suitable for anchoring to the concrete foundation.
- 7.3.2 Enclosure panels, doors and ventilation silencers will be built from non-combustible materials.
- 7.3.3 Acoustic panels should be made from G90 galvanized steel and should be a minimum 4" thick. The solid skin should be a minimum 18ga, and the perforated skin should be a minimum 22ga. The acoustic panels should have minimum 6 lb/cu.ft mineral insulation.
- 7.3.4 The portion of the Enclosure interfacing with the underside of the wind tunnel bell mouth will be manufactured as required to ensure that all exposed exhaust pipe work is fully enclosed acoustically. The contractor may consider interfacing with the existing steel ribs of the bell mouth. See Figure 4.

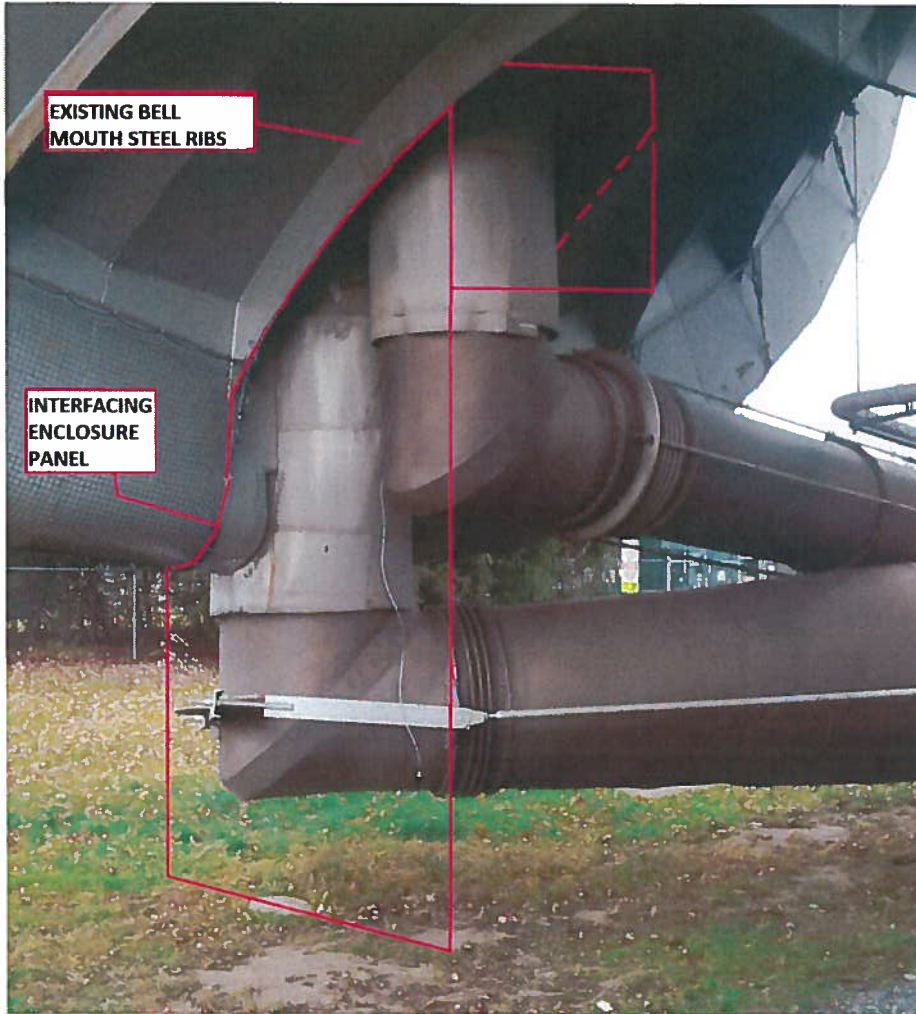

Figure 4. Enclosure / Wind Tunnel Interfacing.

- 7.3.5 The portion of the Enclosure just under the front of the wind tunnel bell mouth will be manufactured to mimic as close as possible, the aerodynamic shape of the existing pipe chase. See Figure 5. It should be noted that the existing pipe work thermal expansion hardware will be modified by NRC as necessary to facilitate this shape.

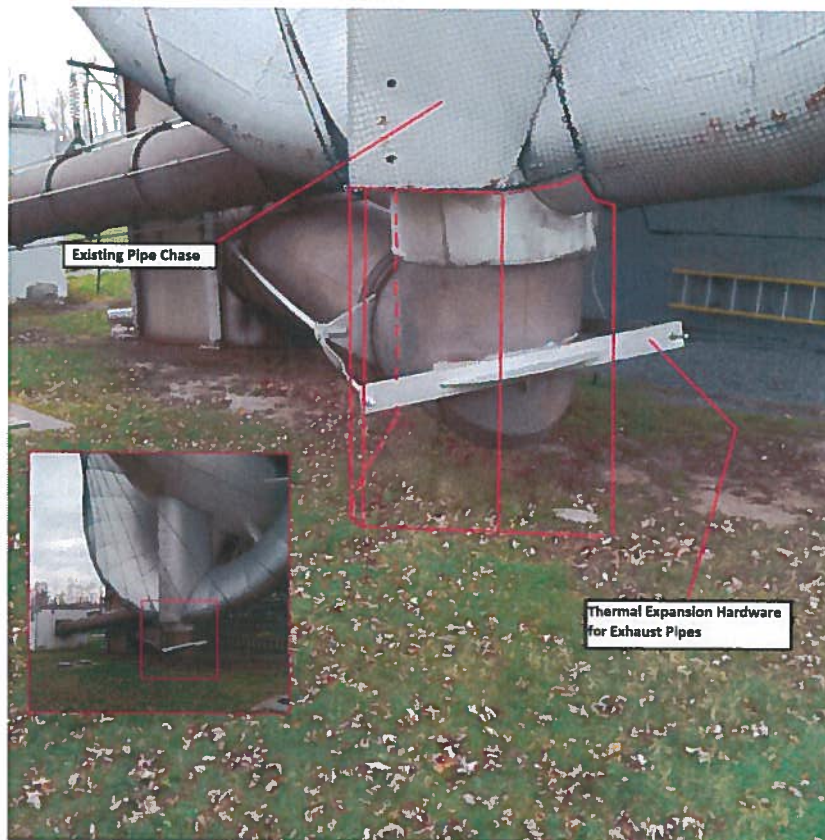

Figure 5. Portion of Enclosure under pipe chase.

- 7.3.6 The Enclosure will have a minimum of two bolt-on access hatches located as required allow personnel to perform bi-annual inspections of the pipework/insulation/cladding as well as the enclosure itself and the ventilation system. The access hatches should be a minimum 4" thick and similar or better construction than the acoustic panels. The hatch should have a minimum of two layers of acoustic seals. It is expected that the area within the enclosure will be considered a confined space and all inspection work within the enclosure will be performed using only temporary and/or hand-held lighting.
- 7.3.7 The Enclosure will be provided with frames, gaskets, fasteners, anchors, hardware, sealing/caulking systems, and all other equipment (including cooling/ventilation) and accessories as indicated, specified and necessary for a complete installation.
- 7.3.8 The ventilation silencers should be made from G90 galvanized steel with solid skin of minimum 18ga and perforated skin of minimum 18ga. The length of the ventilation silencers will be determined based on the required insertion losses, the air resistance losses and the system air flow requirements. Each silencer will be furnished with a bird screen. The screen will have a maximum $\frac{3}{4}$ " X $\frac{3}{4}$ " mesh size and minimum 16ga wire diameter.

- 7.3.9 The surface finish of the Enclosure will be suitably durable to not be blemished (scratch, chip, flake, bubble or wear) under normal operation and maintenance and/or when subjected to the local climate conditions. Shop Painting for any carbon steel surfaces should have a minimum surface preparation as per SSPC-SP6. A recommended finish is one coat of Amercoat 68HS and one coat of Amercoat 450 HSG XX.
- 7.3.10 Galvanized surfaces (G90 or higher) or hot-dipped galvanized surfaces do not require painting.
- 7.3.11 The Contractor will include a supply of touchup paint to repair any blemishing that occurs during the installation.
- 7.3.12 Good finish and appearance will be considered an important requirement including:
- 7.3.12.1 All visible welds will be ground to be uniform in appearance, and all welding splatter will be removed.
- 7.3.12.2 Galvanizing finish will be uniform and free from scratches or visible blemishes.
- 7.3.13 The Contractor will inform NRC of any failure to conform to specified requirements. Nonconforming product will not be released from the Contractor without formal authority from NRC.
- 7.4 Shipping Requirements**
- 7.4.1 The Contractor will deliver the Enclosure components and accessories undamaged with protective wrapping and packaging.
- 7.4.2 If necessary, NRC will store all components and accessories in a clean and dry location prior to installation.
- 7.5 Installation Requirements**
- 7.5.1 The Contractor will provide qualified support to supervise the complete installation of the Enclosure. A trained engineer or equivalent mechanic will be on site to provide, as a minimum:
- 7.5.1.1 Supervision of the final adjustments
- 7.5.1.2 Final checkout of the panels, access hatches, ventilation system and all hardware and accessories
- 7.5.1.3 Inspection of all panel-to-panel and panel-to-frame joints and seals
- 7.5.1.4 Inspection of the final erection and fit of all assemblies and components
- 7.5.2 The Enclosure will be provided with frames, gaskets, fasteners, anchors, hardware, sealing/caulking systems, and all other equipment (including cooling/ventilation) and accessories as indicated, specified and necessary for a complete installation.

7.5.3 The Contractor will provide all materials, tools and equipment (including rigging hardware) to complete this scope of work unless otherwise stated.

7.5.4 The Contractor will use touchup paint where required to repair any blemishing that occurs during the installation and a suitable supply of touchup paint will be provided post-installation.

7.6 Safety Requirements

7.6.1 All work on-site will conform to the applicable Ontario Health and Safety Regulations.

7.6.2 When applicable, the following safety practices will be closely observed and will be strictly adhered to at all times:

7.6.2.1 Personal fall protection;

7.6.2.2 Lockout-tagout;

7.6.2.3 Ladders/scaffolds;

7.6.2.4 Work overhead / Temporary barriers;

7.6.2.5 Hot work practices;

7.6.2.6 Housekeeping;

7.6.2.7 Rigging and hoisting;

7.6.2.8 General PPE use – safety glasses and safety boots

7.7 Existing Facility Interfaces

- 7.7.1 The Enclosure will interface with each of the facility systems listed below as necessary to not compromise the performance of the Enclosure and/or the interfacing systems themselves.
- 7.7.2 A mandatory site visit, during the bidding stage, is required so that the Bidder can become familiar with and verify the general arrangement details of all the existing interfacing systems. All dimensions herein are reasonably accurate but are for tender only. After the Contract is awarded, the Contractor will be responsible to measure and inspect all interfaces as required to facilitate the delivery and integration of the Enclosure as specified herein.

7.7.2.1 The Engine Containment Hut Details

- 7.7.2.1.1 The Engine Containment hut is an existing structure that houses the Gas Turbine Engine. The walls of this structure are 10 inches thick and contain reinforcing bar. The exhaust pipework penetrates the wall of the Containment Hut as per Figure 6.

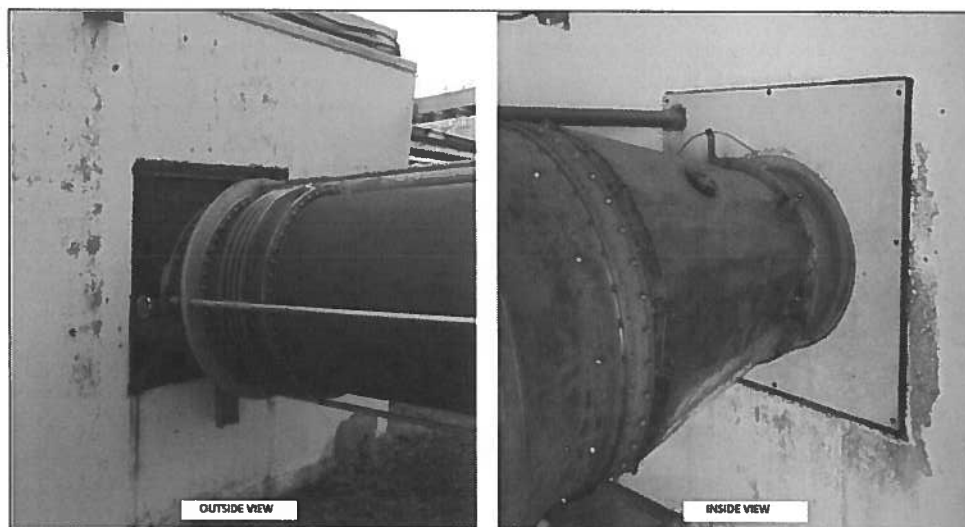

Figure 6. Pipework penetrating containment hut.

7.7.2.2 Concrete Foundation Details

- 7.7.2.2.1 A concrete foundation will be installed by NRC. The Concrete Foundation will not exist at the time this project is tendered but it will exist prior to the installation of the Enclosure and very likely when the Contract is awarded. The foundation is estimated to be a minimum 6 inches thick concrete slab-on-grade. The foundation will be laid out as shown in NRC drawing # SP-M46-PWT-03-00201.

7.7.2.3 Exhaust Stack Details

7.7.2.3.1 The Exhaust Stack is an existing silencer approximately 11.5 feet in diameter.

7.7.2.4 Exhaust Pipework and Insulation Details

7.7.2.4.1 The Exhaust Pipework is the main source of the breakout noise. There are two pipes as arranged as shown in Figure 7 and Figure 8.

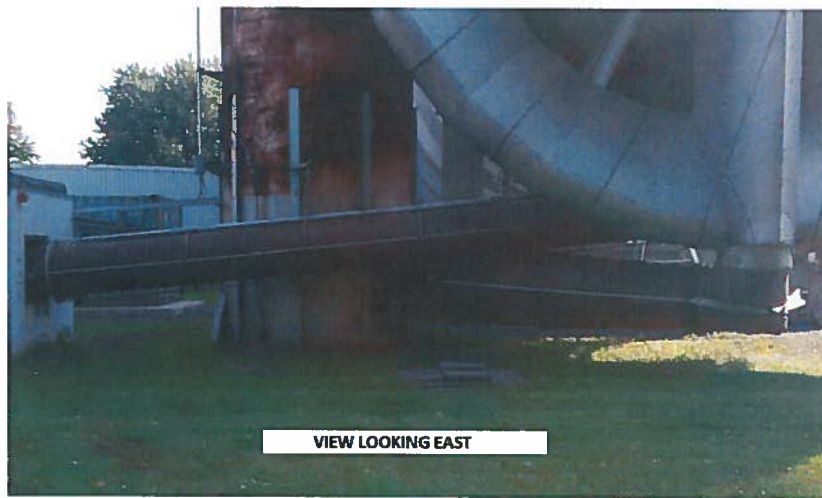

Figure 7. Exhaust Pipework – Looking East.



Figure 8. Exhaust Pipework – Looking North.

- 7.7.2.4.2 The exhaust pipework and a portion of the exhaust stack will be insulated by NRC. The insulation will appear approximately as shown in Figure 9. Since it is to be contained within the Enclosure, the insulation will not have any weatherproof cladding.

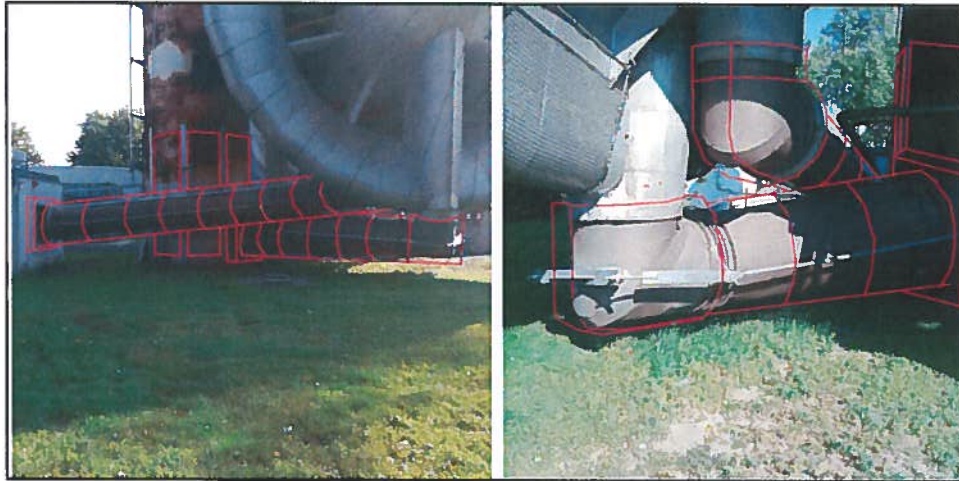

Figure 9. Exhaust Pipework and Stack Insulation.

- 7.7.2.4.3 Under normal operation, the exhaust pipe is exposed to exhaust gas at 600°C [1112°F]. Once the pipe is insulated, it is estimated that the exposed insulation surface temperature will be limited to 100°C [212°F]. All temperature estimates are based on still ambient air at 24°C [75°F].
- 7.7.2.4.4 It should be noted that the insulation will not cover all pipe hanger and thermal expansion hardware, these components could remain exposed to the ambient air within the Enclosure.

7.7.2.5 Facility Electrical System Details

- 7.7.2.5.1 The Facility Electrical System will be used to supply power the ventilation system for the Enclosure. Both 600VAC 3P and 120/208VAC 3P distribution panels are located approximately 25ft from the location of the Enclosure. The Contractor will review possible routing options. The Contractor will supply and install any new required breaker(s).

7.7.2.6 Facility Control System Details

- 7.7.2.6.1 The contractor will supply and install the required wiring, conduit, tray, motor starters, safety disconnect and any other equipment required to meet all applicable electrical codes. The motor starters will have local control (ON/OFF buttons) and provision for remote control and monitoring from an NRC Facility Control System (LOCAL/REMOTE switch). NRC will be responsible to provide the remote control. The contractor will determine the mounting location for the motor starters and obtain NRC approval for the proposed location.

7.8 Documentation Requirements

7.8.1 The Contractor will issue 3 copies of the operational/maintenance literature. The literature will include, as a minimum - general operation requirements, a pre-operational inspection checklist, a post-operational inspection checklist, a critical spare parts list and a preventative maintenance schedule. This will be due 2 weeks prior to shipment of the Enclosure.

7.9 Schedule Requirements

7.9.1 The Contractor will complete the installation of the Enclosure before March 31st, 2015.

7.9.2 See also the milestone matrix in Annex A.

ANNEX A

MILESTONE MATRIX

Milestone Matrix

Milestone	Reference Section	Delivery Date
Structural Calculations	7.2.6.1	3 weeks ARO
Ventilation Calculations	7.2.6.2	2 weeks ARO
General Arrangement Drawings	7.2.6.3.1	4 weeks ARO
Operational/Maintenance Literature	7.8.1	2 weeks prior to shipment

NRC

M46 ENGINE EXHAUST PIPE ACOUSTIC ENCLOSURE

NOTES:

- PANEL CONSTRUCTION**
 - 4" THICK
 - OUTSIDE SKIN - G-90 SOLID
 - INSIDE SKIN - G-90 PERFORATED
 - INTERNAL CHANNELS - G-90 SOLID
 - ACOUSTIC FILL - MINERAL WOOL
 - FINISH - UNPAINTED
- LOCATIONS AND SIZES OF ALL OPENINGS TO BE CONFIRMED BY NRC; OTHERWISE OPENINGS TO BE CUT ON FIELD
- VENDOR TO SUPPLY EXTRA FLASHING, INSULATION AND FASTENERS REQUIRED TO FILL IN AROUND FIELD PENETRATIONS AND OPENINGS.

**ENCLOSURE ASSEMBLY LAYOUT DRAWINGS
SHOWN FOR TENDER ONLY.
ENCLOSURE FOR TENDER ONLY.
SHOWN FOR TENDER ONLY.
ALL DIMENSIONS SHOWN ON FIELD.
NEED TO BE VERIFIED THEIR OWN DESIGN AND
DRAWINGS.**

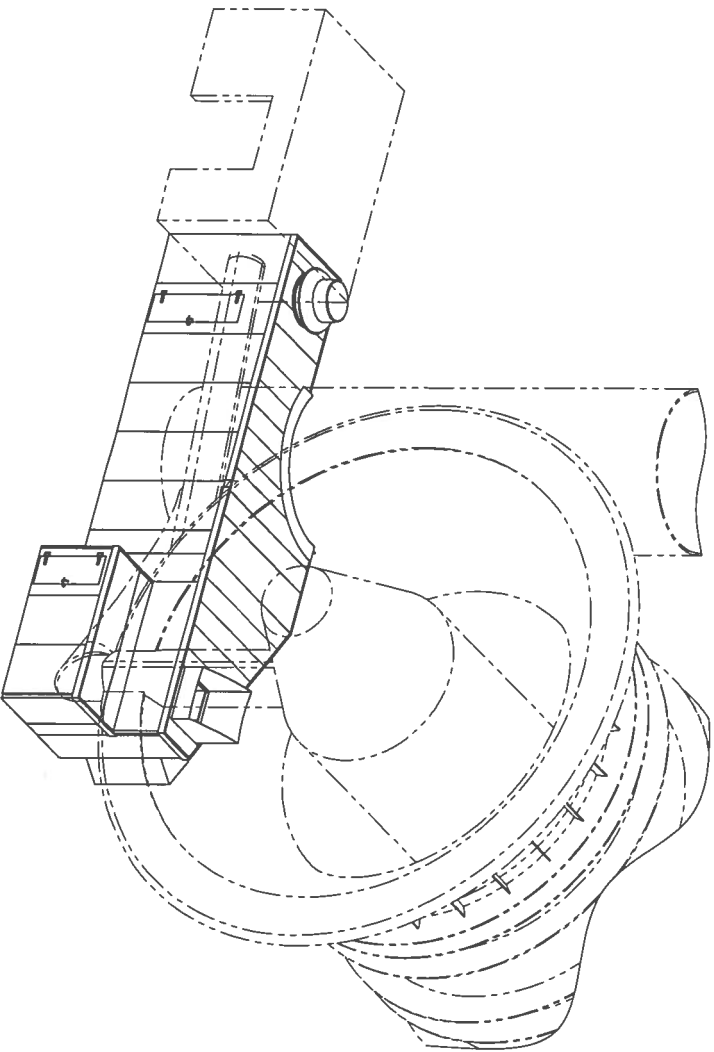

PROJECT	M46 ENGINE EXHAUST PIPE ACOUSTIC ENCLOSURE	ENCLOSURE ASSEMBLY
CUSTOMER	NRC	GENERAL ARRANGEMENT
DWG. NO.	2132	REV
	SHEET 1 OF 4	0

REV	REVISION DESCRIPTION	BY	DATE
8			

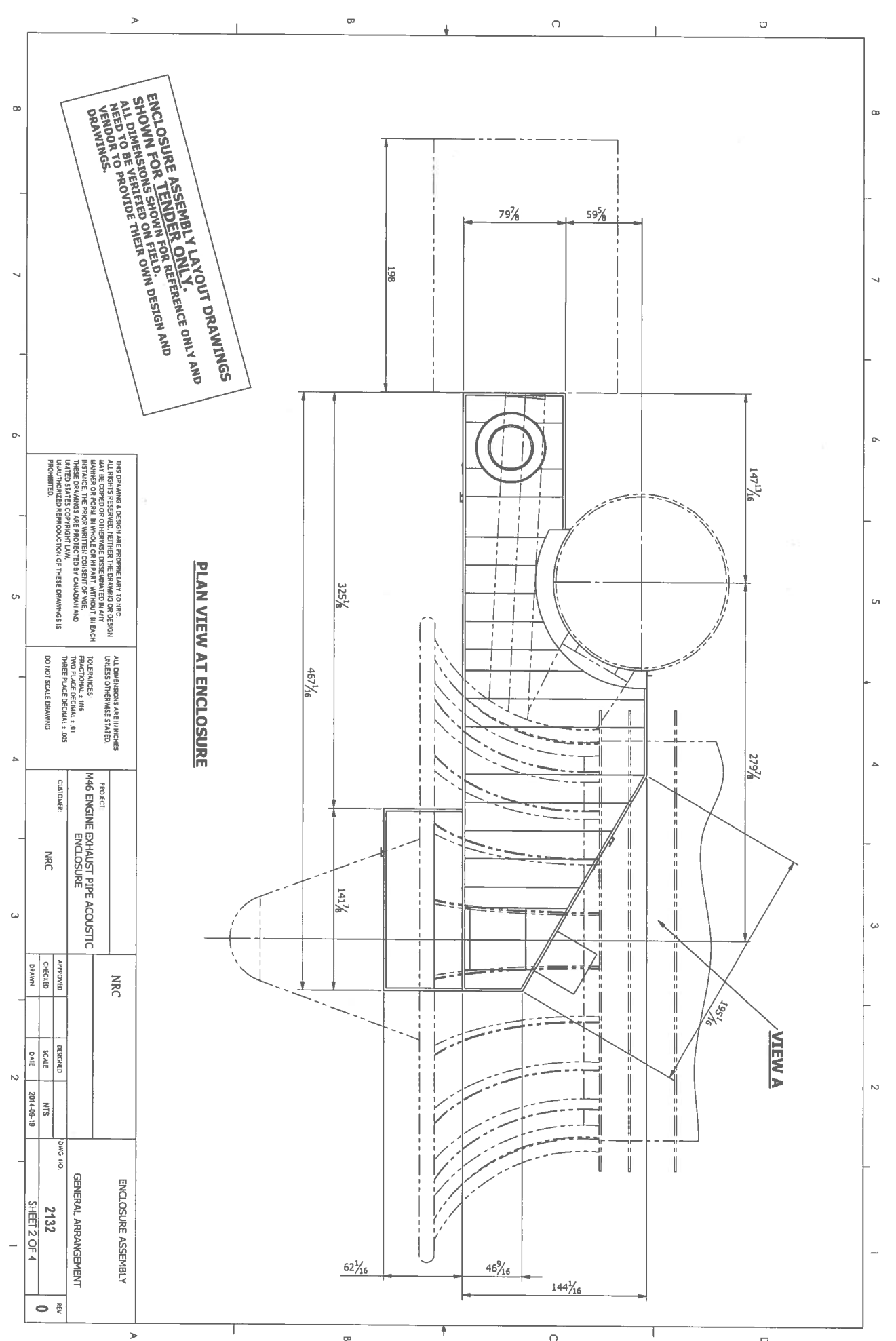

PLAN VIEW AT ENCLOSURE

ENCLOSURE ASSEMBLY LAYOUT DRAWINGS SHOWN FOR TENDER ONLY. ALL DIMENSIONS SHOWN FOR REFERENCE ONLY AND NEED TO BE VERIFIED THEIR OWN DESIGN AND DRAWINGS.

THIS DRAWING IS A SPECIALTY PROPERTY OF JMC. ALL RIGHTS RESERVED. NEITHER THE DRAWING OR DESIGN MAY BE COPIED OR OTHERWISE REPRODUCED IN ANY MANNER OR FORM, IN WHOLE OR IN PART, WITHOUT IN EACH INSTANCE THE PRIOR WRITTEN CONSENT OF JMC. UNLAWFUL REPRODUCTION OF THIS DRAWING IS PROHIBITED.

ALL DIMENSIONS ARE IN INCHES UNLESS OTHERWISE SPECIFIED.
TOLERANCES:
FRACTIONAL: ± .01
THREE PLACE DECIMAL: ± .005
DO NOT SCALE DRAWING

PROJECT: M46 ENGINE EXHAUST PIPE ACOUSTIC ENCLOSURE
CUSTOMER: NRC

APPROVED: [Signature Box]
CHECKED: [Signature Box]
DRAWN: [Signature Box]

ENCLOSURE ASSEMBLY
GENERAL ARRANGEMENT
DWG. NO. 2132
SHEET 2 OF 4
REV 0

8 7 6 5 4 3 2 1
A B C D

**ENCLOSURE ASSEMBLY LAYOUT DRAWINGS
SHOWN FOR TENDER ONLY. ALL DIMENSIONS SHOWN IN FIELD
NEED TO BE VERIFIED BY THE VENDOR TO PROVIDE THEIR OWN DESIGN AND DRAWINGS.**

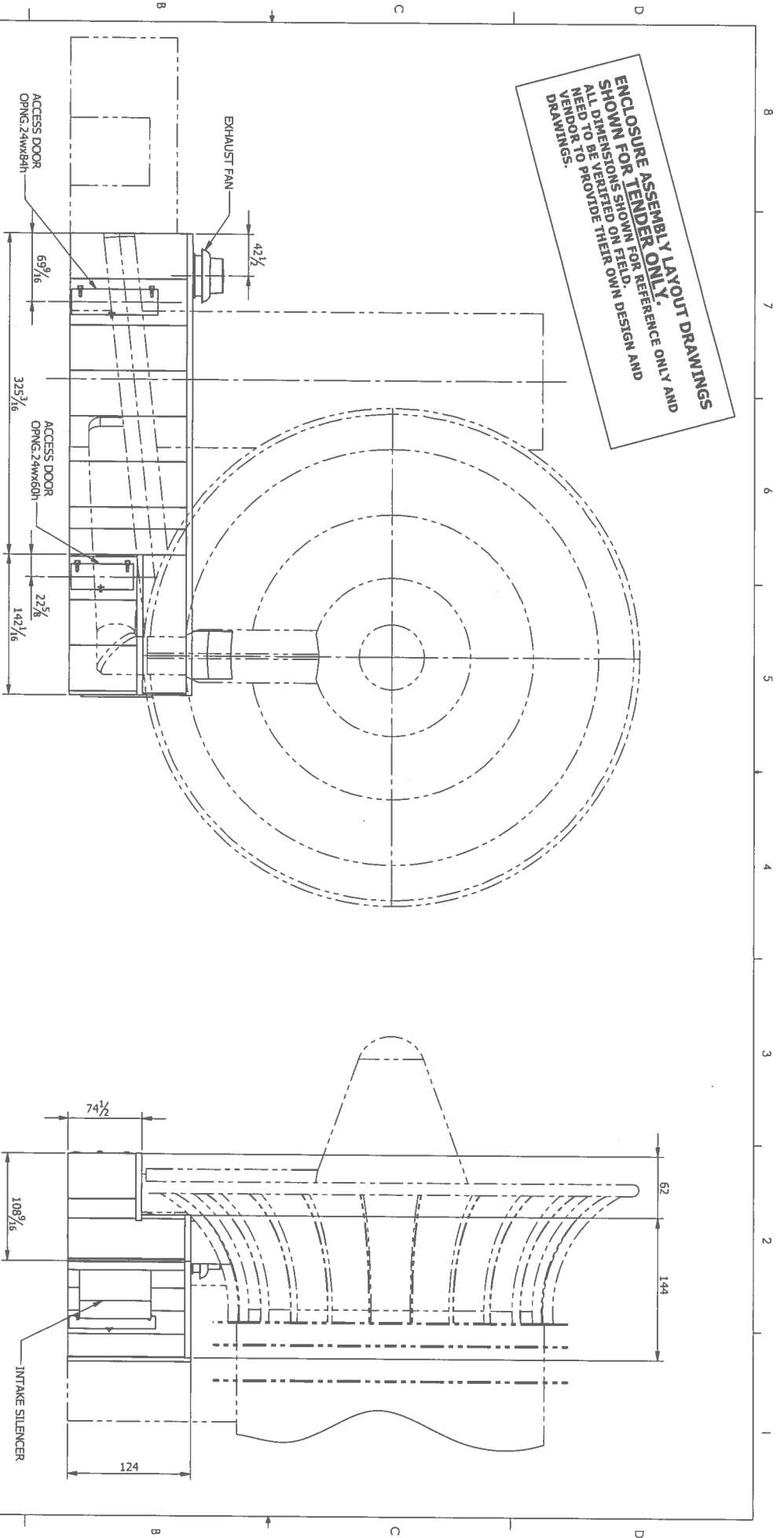

FRONT ELEVATION

LEFT ELEVATION

THIS DRAWING & DESIGN ARE PROPRIETARY TO JRC. ALL RIGHTS RESERVED. NEITHER THE DRAWING OR DESIGN MAY BE COPIED OR OTHERWISE REPRODUCED IN ANY MANNER OR FOR ANY PURPOSE WITHOUT THE WRITTEN PERMISSION OF JRC. THESE DRAWINGS ARE PROVIDED BY CONTRACT AND UNAUTHORIZED REPRODUCTION OF THESE DRAWINGS IS PROHIBITED.

ALL DIMENSIONS ARE IN INCHES UNLESS OTHERWISE STATED.
TOLERANCES
FRACTIONAL, ± 1/16
TWO PLACE DECIMAL, ± .01
THREE PLACE DECIMAL, ± .005
DO NOT SCALE DRAWING

PROJECT:		M46 ENGINE EXHAUST PIPE ACOUSTIC ENCLOSURE	
CUSTOMER:		NRC	
APPROVED:		DRAWN:	
CHECKED:		DATE:	
RECORD:		SCALE:	
DATE:		201409-19	
DWG. NO.:		2132	
GENERAL ARRANGEMENT:		SHEET 3 OF 4	
REV:		0	

8 7 6 5 4 3 2 1

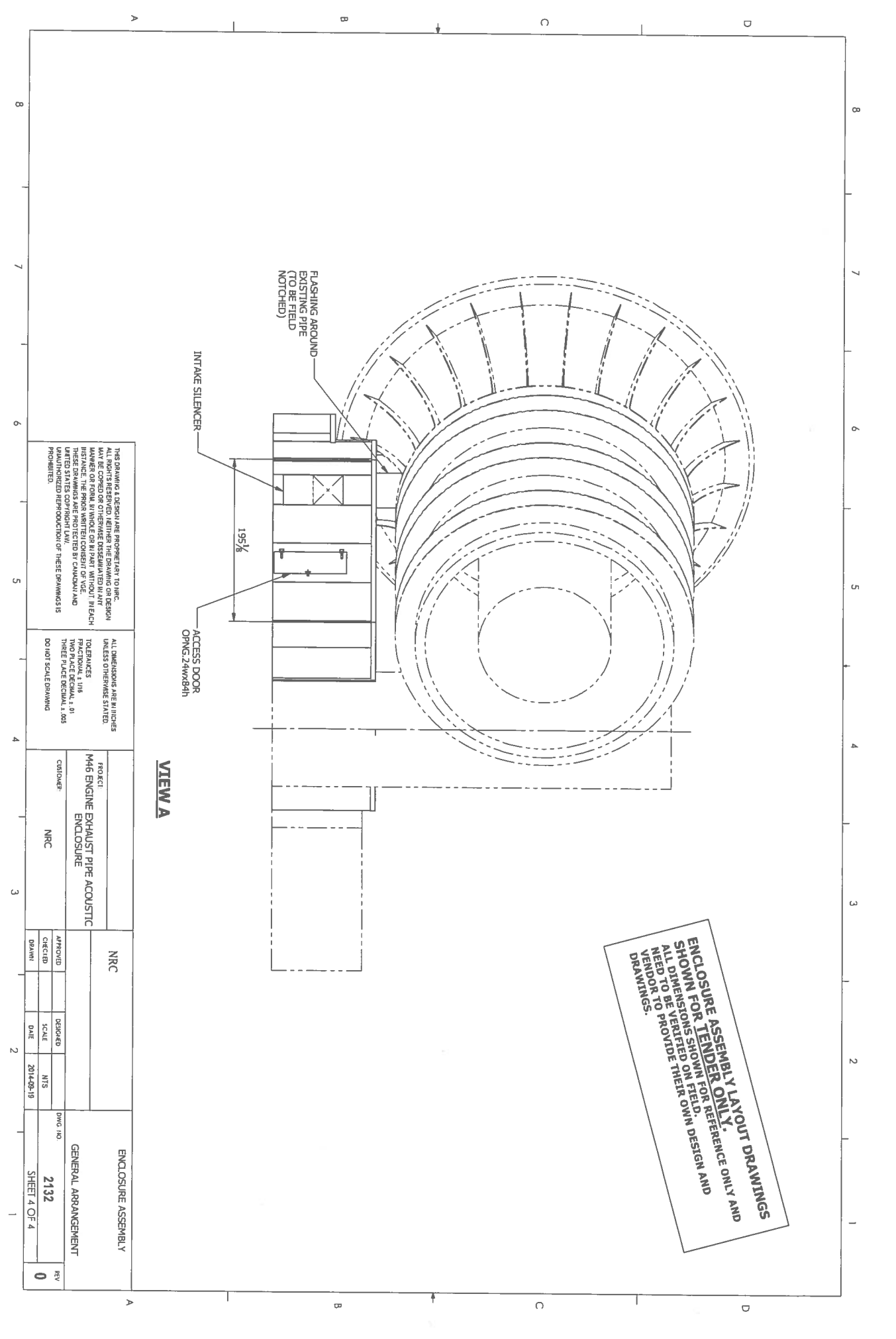

**ENCLOSURE ASSEMBLY LAYOUT DRAWINGS
 SHOWN FOR TENDER ONLY.
 ALL DIMENSIONS SHOWN FOR REFERENCE ONLY AND
 NEED TO BE VERIFIED THEIR OWN DESIGN AND
 DRAWINGS.**

VIEW A

THIS DRAWING & SPECIFICATIONS ARE PROPRIETARY TO NRC. ALL RIGHTS RESERVED. NEITHER THE DRAWING OR DESIGN MAY BE COPIED OR OTHERWISE REPRODUCED IN ANY MANNER OR FOR ANY PURPOSE OR IN PART WITHOUT THE WRITTEN PERMISSION OF NRC. UNLESS OTHERWISE SPECIFIED, DIMENSIONS ARE IN INCHES. FRACTIONAL DIMENSIONS SHALL BE SHOWN AS DECIMALS. UNLESS OTHERWISE SPECIFIED, DIMENSIONS SHALL BE TO FACE UNLESS OTHERWISE SPECIFIED. UNAUTHORIZED REPRODUCTION OF THESE DRAWINGS IS PROHIBITED.

ALL DIMENSIONS ARE IN INCHES UNLESS OTHERWISE STATED.
 TOLERANCES
 FRACTIONAL ± .015
 TWO PLACE DECIMAL ± .01
 THREE PLACE DECIMAL ± .005
 DO NOT SCALE DRAWING

PROJECT:		M46 ENGINE EXHAUST PIPE ACOUSTIC ENCLOSURE	
CUSTOMER:		NRC	
APPROVED:		DESIGNED:	DWG. NO.
CHECKED:	SCALE:	DATE:	2132
DRAWN:	DATE:	2014-09-19	SHEET 4 OF 4
ENCLOSURE ASSEMBLY			REV
GENERAL ARRANGEMENT			0

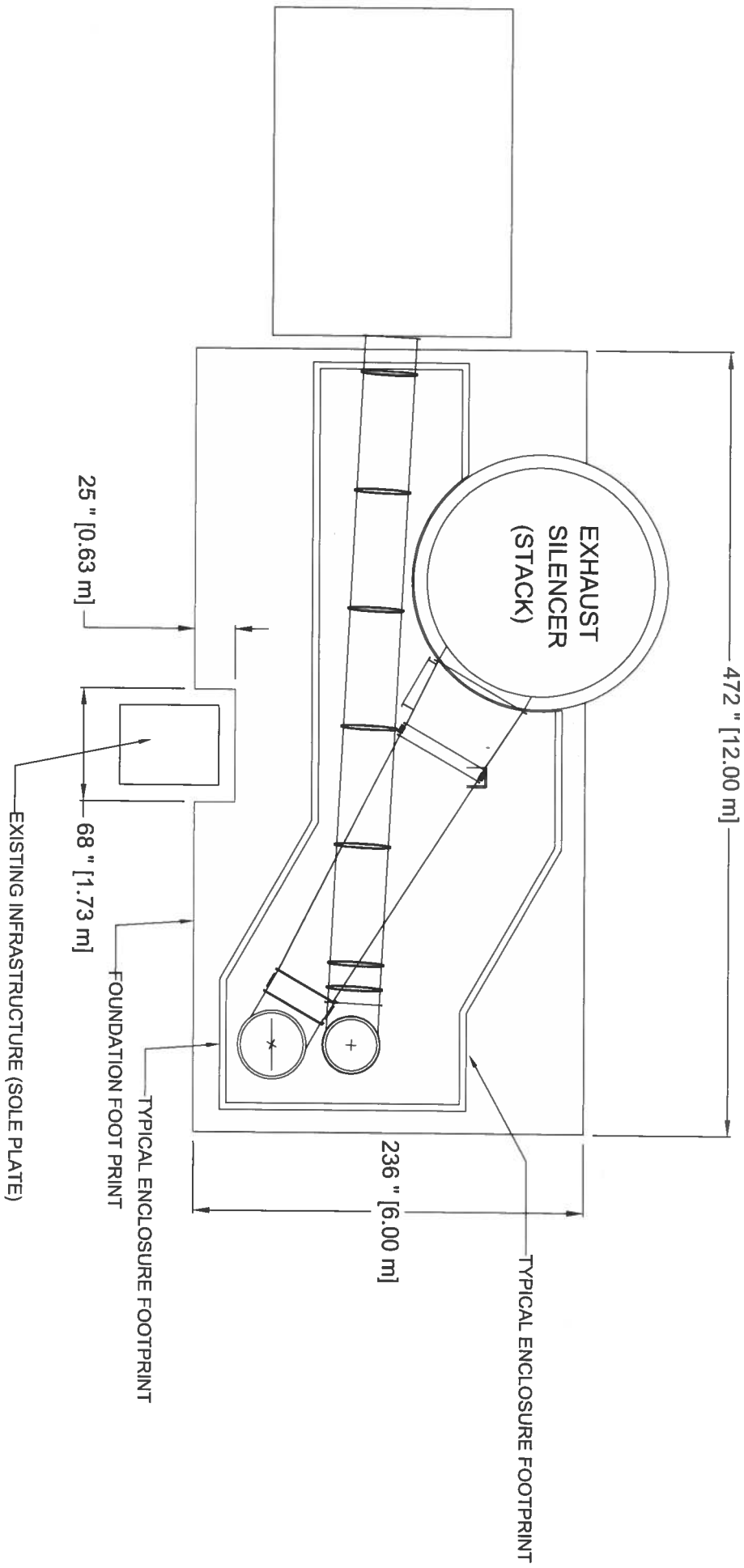

FOUNDATION LAYOUT

**STANDARD INSTRUCTIONS AND CONDITIONS:
(APPLICABLE TO BID SOLICITATION)**

1. Submission of Bids

1.1 It is the Bidder's responsibility to:

- (a) return a signed original of the bid solicitation, duly completed, IN THE FORMAT REQUESTED;
- (b) direct its bid ONLY to the Bid Receiving address specified;
- (c) ensure that the Bidder's name, the bid solicitation reference number, and bid solicitation closing date and time are clearly visible;
- (d) provide a comprehensive and sufficiently detailed bid, including all requested pricing details, that will permit a complete evaluation in accordance with the criteria set out in the bid solicitation.

Timely and correct delivery of bids to the specified bid delivery address is the sole responsibility of the Bidder. The National Research Council Canada (NRC) will not assume or have transferred to it those responsibilities. All risks and consequences of incorrect delivery of bids are the responsibility of the Bidder.

1.2 Bids may be accepted in whole or in part. The lowest or any bid will not necessarily be accepted. In the case of error in the extension of prices, the unit price will govern. NRC may enter into contract without negotiation.

1.3 Bidders who submit a bid agree to be bound by the instructions, clauses and conditions of the bid solicitation and accept the terms and conditions of the resulting contract.

1.4 Bids will remain open for acceptance for a period of not less than sixty (60) days from the closing date of the bid solicitation, unless otherwise indicated by NRC in such bid solicitation.

1.5 While NRC may enter into contract without negotiation, Canada reserves the right to negotiate with bidders on any procurement.

1.6 Notwithstanding the bid validity period stipulated in this solicitation, Canada reserves the right to seek an extension from all responsive bidders, within a minimum of three (3) days prior to the end of such period. Bidders shall have the option to either accept or reject the extension.

1.7 If the extension referred to above is accepted, in writing, by all those who submitted responsive bids, then Canada shall continue immediately with the evaluation of the bids and its approval processes.

1.8 If the extension referred to above is not accepted, in writing, by all those who submitted responsive bids then Canada shall, at its sole discretion: either continue to evaluate the responsive bids of those who have accepted the extension and seek the necessary approvals; or cancel the solicitation; or cancel and reissue the solicitation.

2. Late Bids

2.1 It is NRC policy to return, unopened, bids delivered after the stipulated bid solicitation closing date and time, unless they qualify as a delayed bid as described below.

3. Delayed Bids

3.1 A bid delivered to the specified Bid Receiving area after the closing date and time but before the contract award date may be considered, provided the delay can be proven to have been due solely to a delay in delivery that can be attributed to the Canada Post Corporation (CPC) (or national equivalent of a foreign country). The only pieces of evidence relating to a delay in the CPC system that are acceptable to NRC are:

- (a) CPC cancellation date stamp;
- (b) a CPC Priority Courier Bill of Lading; and
- (c) a CPC Xpresspost Label,

that clearly indicate that the bid was mailed prior to the bid closing date.

Example: If the bid closing date was May 15, 1995, then the CPC cancellation date stamp should read no later than May 14, 1995, to be accepted.

3.2 Please request the postal employee to date-stamp your envelope.

3.3 For bids transmitted by facsimile or commercial telegram, only the date and the time of receipt recorded by NRC at the Bid Receiving number stated in the bid solicitation will be accepted as evidence of a delayed bid.

3.4 Misrouting, traffic volume, weather disturbances, or any other causes for the late delivery of bids are not acceptable reasons for the bid to be accepted by NRC.

4. Postage Meters

4.1 Postage meter imprints, whether imprinted by the Supplier, the CPC or the postal authority outside Canada, are not acceptable as proof of timely mailing. It should be noted that CPC does not normally apply a cancellation date stamp to metered mail; this is usually done only when postage stamps are used.

5. Responses Transmitted by Facsimile or Commercial Telegram

5.1 If you are in doubt that your bid will be delivered on time at the specific location designated for the receipt of the bid, you may use a facsimile or a commercial telegram, unless otherwise instructed in the bid solicitation.

Due to the volume of technical material required for some bids, certain bid solicitations may specify that submissions by facsimile or commercial telegram are not acceptable (e.g. science solicitations).

5.2 Unless otherwise instructed in the bid solicitation, the only acceptable number for responses to bid solicitations issued by NRC headquarters sectors is facsimile number (613) 991-3297.

5.3 If the bidder chooses to submit a facsimile or commercial telegram bid, NRC will not be responsible for any failure attributable to the transmission or receipt of the facsimile bid including, but not limited to the following:

- (a) receipt of garbled or incomplete bid;
- (b) availability or condition of the receiving facsimile equipment;
- (c) incompatibility between the sending and receiving equipment;
- (d) delay in transmission or receipt of the bid;
- (e) failure of the Bidder to properly identify the bid;
- (f) illegibility of the bid; or
- (g) security of bid data.

5.4 Bids submitted by facsimile or commercial telegram will constitute your formal bid and must contain:

- (a) the bid reference number;
- (b) the closing date and time;
- (c) sufficient data to allow evaluation, such as unit prices, country of currency in the event that the bid is submitted in a foreign currency, sales tax, duty, technical data (where applicable) and any deviation(s) from the bid solicitation document.

5.5 For responses transmitted by facsimile or commercial telegram, written confirmation is required within two (2) working days after bid closing, unless otherwise specified in this solicitation. All documents confirming bids should bear the word "CONFIRMATION".

5.6 NRC does not undertake to protect the confidentiality of the transmission of any document sent by facsimile. Vendors concerned with the confidentiality of their documents are advised to submit their proposals in sealed envelopes.

6. Customs Clearance

6.1 It is the responsibility of the Bidder to allow sufficient time to obtain customs clearance, where required, before the scheduled bid closing date and time. Delays related to the obtaining of customs clearance cannot be construed as "undue delay in the mail" and will not be accepted under the Late Bids Policy.

For further information, please contact the Contracting Authority identified in the bid solicitation.

bid instructions_rfp.doc

Evaluation Grid for Modular Acoustic Enclosure for M46 Wind Tunnel

Name of Bidder: _____

Solicitation No.: _____

7.2.2 Operating Conditions

7.2.2.1 The Enclosure will function and perform as specified herein when the ambient temperature is between -40°C and +40°C.

Compliant: _____

Non-Compliant as follows:

7.2.2.2 The Enclosure will function and perform as specified herein when subjected to typical year-round weather conditions that would be expected at the installation location.

Compliant: _____

Non-Compliant as follows:

7.2.3 Design Life

7.2.3.1 The Enclosure will have a 20 Year life without failure when operated and maintained as per the operation and maintenance instructions.

Compliant: _____

Non-Compliant as follows:

7.2.4 Performance Requirements – Ventilation

7.2.4.1 The Contractor will specify and install a ventilation system in the Enclosure to remove the heat generated by the exhaust pipework. The ventilation system will be designed to ensure that, under normal operating engine conditions, when the outside air temperature is 40°C [104°F], the overall temperature of the air inside the Enclosure does not exceed 60°C [140°F].

Compliant: _____

Non-Compliant as follows:

7.2.4.2 The Ventilation System will have silencers on both the intake and exhaust. The intake will be high enough off the ground such that loose grass, snow and/or any other debris is not ingested into the enclosure.

Compliant: _____

Non-Compliant as follows:

7.2.5 Performance Requirements – Acoustic

7.2.5.1 The acoustic panels will have minimum Sound Transmission Loss values vs. frequency as per Table 1. To demonstrate this, the Contractor will submit, at the bidding stage, results of a test performed in accordance with ASTM E90.

Frequency (Hz)	125	250	500	1k	2k	4k
T.L. (dB)	17	27	37	48	49	51

Table 1. Transmission Loss Requirements for Panel.

Compliant: _____

Non-Compliant as follows:

7.2.5.2 The acoustic panels will have minimum Sound Absorption Coefficient values vs. frequency as per Table 2. To demonstrate this, the Contractor will submit at the bidding stage, the results of a test performed in accordance with ASTM C423.

Frequency (Hz)	125	250	500	1k	2k	4k
Absorption Coefficient	0.7	0.75	1	1	0.95	0.9

Table 2. Absorption Coefficient Values for Panel.

Compliant: _____

Non-Compliant as follows:

7.2.5.3 The ventilation silencers (both intake and exhaust) will be designed to have minimum insertion loss values vs. frequency as per table 3.

Frequency (Hz)	63	125	250	500	1k	2k	4k	8k
I.L. (dB)	4	10	27	50	50	50	33	19

Table 3. Insertion Loss Values for Ventilation Silencers.

Compliant: _____

Non-Compliant as follows:

7.2.6 General Engineering Requirements

7.2.6.1 The Contractor will perform calculations demonstrating the structural integrity of the Enclosure and compliance with the Ontario Building Code (OBC) and any applicable local codes. This calculation will be delivered to NRC three weeks ARO.

Compliant: _____

Non-Compliant as follows:

7.2.6.2 The Contractor will perform calculations to determine the ventilation requirements and select a suitable ventilation system. The calculations will consider air resistance losses from the intake and exhaust silencers as well as insulation surface temperature. This calculation will be delivered to NRC two weeks ARO.

Compliant: _____

Non-Compliant as follows:

7.2.6.3 The Contractor will prepare Enclosure drawings to be reviewed and approved by NRC. These drawings will include the following:

7.2.6.3.1 General Arrangement details such as the size of structural members, the details of the structural supports, typical panel construction, and the typical panel to panel and panel to facility structure connections. All drawings shall accurately represent, in detail, the Enclosure which is to be supplied under the Contract. This calculation will be delivered to NRC four weeks ARO.

Compliant: _____

Non-Compliant as follows:

7.3 Fabrication Requirements

7.3.1 The Contractor will ensure that structural frames, if any, will be suitable for anchoring to the concrete foundation.

Compliant: _____

Non-Compliant as follows:

7.3.2 Enclosure panels, doors and ventilation silencers will be built from non-combustible materials.

Compliant: _____

Non-Compliant as follows:

7.3.4 The portion of the Enclosure interfacing with the underside of the wind tunnel bell mouth will be manufactured as required to ensure that all exposed exhaust pipe work is fully enclosed acoustically.

Compliant: _____

Non-Compliant as follows:

7.3.5 The portion of the Enclosure just under the front of the wind tunnel bell mouth will be manufactured to mimic as close as possible, the aerodynamic shape of the existing pipe chase.

Compliant: _____

Non-Compliant as follows:

7.3.6 The Enclosure will have a minimum of two bolt-on access hatches located as required allow personnel to perform bi-annual inspections of the pipework/insulation/cladding as well as the enclosure itself and the ventilation system.

Compliant: _____

Non-Compliant as follows:

7.3.7 The Enclosure will be provided with frames, gaskets, fasteners, anchors, hardware, sealing/caulking systems, and all other equipment (including cooling/ventilation) and accessories as indicated, specified and necessary for a complete installation.

Compliant: _____

Non-Compliant as follows:

7.3.8 The length of the ventilation silencers will be determined based on the required insertion losses, the air resistance losses and the system air flow requirements. Each silencer will be furnished with a bird screen. The screen will have a maximum ¾" X ¾" mesh size and minimum 16ga wire diameter.

Compliant: _____

Non-Compliant as follows:

7.3.9 The surface finish of the Enclosure will be suitably durable to not blemished (scratch, chip, flake, bubble or wear) under normal operation and maintenance and/or when subjected to the local climate conditions.

Compliant: _____

Non-Compliant as follows:

7.3.11 The Contractor will include a supply of touchup paint to repair any blemishing that occurs during the installation.

Compliant: _____

Non-Compliant as follows:

7.3.12 Good finish and appearance will be considered an important requirement including:

7.3.12.1 All visible welds will be ground to be uniform in appearance, and all welding splatter will be removed.

Compliant: _____

Non-Compliant as follows:

7.3.12.2 Galvanizing finish will be uniform and free from scratches or visible blemishes.

Compliant: _____

Non-Compliant as follows:

7.3.13 The Contractor will inform NRC of any failure to conform to specified requirements. Nonconforming product will not be released from the Contractor without formal authority from NRC.

Compliant: _____

Non-Compliant as follows:

7.4 Shipping Requirements

7.4.1 The Contractor will deliver the Enclosure components and accessories undamaged with protective wrapping and packaging.

Compliant: _____

Non-Compliant as follows:

7.5 Installation Requirements

7.5.1 The Contractor will provide qualified support to supervise the complete installation of the Enclosure. A trained engineer or equivalent mechanic will be on site to provide, as a minimum:

7.5.1.1 Supervision of the final adjustments

Compliant: _____

Non-Compliant as follows:

7.5.1.2 Final checkout of the panels, access hatches, ventilation system and all hardware and accessories

Compliant: _____

Non-Compliant as follows:

7.5.1.3 Inspection of all panel-to-panel and panel-to-frame joints and seals

Compliant: _____

Non-Compliant as follows:

7.5.1.4 Inspection of the final erection and fit of all assemblies and components

Compliant: _____

Non-Compliant as follows:

7.5.2 The Enclosure will be provided with frames, gaskets, fasteners, anchors, hardware, sealing/caulking systems, and all other equipment (including cooling/ventilation) and accessories as indicated, specified and necessary for a complete installation.

Compliant: _____

Non-Compliant as follows:

7.5.3 The Contractor will provide all materials, tools and equipment (including rigging hardware) to complete this scope of work unless otherwise stated.

Compliant: _____

Non-Compliant as follows:

7.5.4 The Contractor will use touchup paint where required to repair any blemishing that occurs during the installation and a suitable supply of touchup paint will be provided post-installation.

Compliant: _____

Non-Compliant as follows:

7.6 Safety Requirements

7.6.1 All work on-site will conform to the applicable Ontario Health and Safety Regulations.

Compliant: _____

Non-Compliant as follows:

7.6.2 When applicable, the following safety practices will be closely observed and will be strictly adhered to at all times:

- 7.6.2.1 Personal fall protection;
- 7.6.2.2 Lockout-tagout;
- 7.6.2.3 Ladders/scaffolds;
- 7.6.2.4 Work overhead / Temporary barriers;
- 7.6.2.5 Hot work practices;
- 7.6.2.6 Housekeeping;
- 7.6.2.7 Rigging and hoisting;
- 7.6.2.8 General PPE use – safety glasses and safety boots

Compliant: _____

Non-Compliant as follows:

7.7 Existing Facility Interfaces

7.7.1 The Enclosure will interface with each of the facility systems listed below as necessary to not compromise the performance of the Enclosure and/or the interfacing systems themselves.

Compliant: _____

Non-Compliant as follows:

7.7.2 A mandatory site visit, during the bidding stage, is required so that the Bidder can become familiar with and verify the general arrangement details of all the existing interfacing systems. All dimensions herein are reasonably accurate but are for tender only. After the Contract is awarded, the Contractor will be responsible to measure and inspect all interfaces as required to facilitate the delivery and integration of the Enclosure as specified herein.

Compliant: _____

Non-Compliant as follows:

7.7.2.5 Facility Electrical System Details

7.7.2.5.1 The Facility Electrical System will be used to supply power the ventilation system for the Enclosure. Both 600VAC 3P and 120/208VAC 3P distribution panels are located approximately 25ft from the location of the Enclosure. The Contractor will review possible routing options. The Contractor will supply and install any new required breaker(s).

Compliant: _____

Non-Compliant as follows:

7.7.2.6 Facility Control System Details

7.7.2.6.1 The contractor will supply and install the required wiring, conduit, tray, motor starters, safety disconnect and any other equipment required to meet all applicable electrical codes. The motor starters will have local control (ON/OFF buttons) and provision for remote control and monitoring from an NRC Facility Control System (LOCAL/REMOTE switch). NRC will be responsible to provide the remote control. The contractor will determine the mounting location for the motor starters and obtain NRC approval for the proposed location.

Compliant: _____

Non-Compliant as follows:

7.8 Documentation Requirements

7.8.1 The Contractor will issue 3 copies of the operational/maintenance literature. The literature will include, as a minimum - general operation requirements, a pre-operational inspection checklist, a post-operational inspection checklist, a critical spare parts list and a preventative maintenance schedule. This will be due 2 weeks prior to shipment of the Enclosure.

Compliant: _____

Non-Compliant as follows:

7.9 Schedule Requirements

7.9.1 The Contractor will complete the installation of the Enclosure before March 31st, 2015.

Compliant: _____

Non-Compliant as follows:



ID	2035 – Appendix D
Title	General Conditions - Services
Date	2011-05-16
Status	Active

- 01 Interpretation
- 02 Powers of Canada
- 03 Status of the Contractor
- 04 Conduct of the Work
- 05 Subcontracts
- 06 Specifications
- 07 Replacement of Specific Individuals
- 08 Time of the Essence
- 09 Excusable Delay
- 10 Inspection and Acceptance of the Work
- 11 Invoice Submission
- 12 Taxes
- 13 Transportation Costs
- 14 Transportation Carriers' Liability
- 15 Payment Period
- 16 Interest on Overdue Accounts
- 17 Compliance with Applicable Laws
- 18 Ownership
- 19 Copyright
- 20 Translation of Documentation
- 21 Confidentiality
- 22 Government Property
- 23 Liability
- 24 Intellectual Property Infringement and Royalties
- 25 Amendment and Waivers
- 26 Assignment
- 27 Suspension of the Work
- 28 Default by the Contractor
- 29 Termination for Convenience
- 30 Accounts and Audit
- 31 Right of Set-off
- 32 Notice
- 33 Conflict of Interest and Values and Ethics Codes for the Public Service
- 34 No Bribe or Conflict
- 35 Survival
- 36 Severability
- 37 Successors and Assigns
- 38 Contingency Fees
- 39 International Sanctions
- 40 Harassment in the Workplace
- 41 Entire Agreement



2035 01 (2008-05-12) Interpretation

In the Contract, unless the context otherwise requires:

"Articles of Agreement" means the clauses and conditions incorporated in full text to form the body of the Contract; it does not include these general conditions, any supplemental general conditions, annexes, the Contractor's bid or any other document;

"Canada", "Crown", "Her Majesty" or "the Government" means Her Majesty the Queen in right of Canada as represented by the National Research Council of Canada and any other person duly authorized to act on behalf of the National Research Council Canada.

"Contract" means the Articles of Agreement, these general conditions, any supplemental general conditions, annexes and any other document specified or referred to as forming part of the Contract, all as amended by agreement of the Parties from time to time;

"Contracting Authority" means the person designated by that title in the Contract, or by notice to the Contractor, to act as Canada's representative to manage the Contract;

"Contractor" means the person, entity or entities named in the Contract to supply goods, services or both to Canada;

"Contract Price" means the amount stated in the Contract to be payable to the Contractor for the Work, exclusive of Goods and Services Tax and Harmonized Sales Tax;

"Government Property" means anything supplied to the Contractor by or on behalf of Canada for the purposes of performing the Contract and anything acquired by the Contractor in any manner in connection with the Work, the cost of which is paid by Canada under the Contract;

"Party" means Canada, the Contractor, or any other signatory to the Contract and "Parties" means all of them;

"Specifications" means the description of the essential, functional or technical requirements of the Work in the Contract, including the procedures for determining whether the requirements have been met;

"Work" means all the activities, services, goods, equipment, matters and things required to be done, delivered or performed by the Contractor under the Contract.

2035 02 (2008-05-12) Powers of Canada

All rights, remedies, powers and discretions granted or acquired by Canada under the Contract or by law are cumulative, not exclusive.

2035 03 (2008-05-12) Status of the Contractor

The Contractor is an independent contractor engaged by Canada to perform the Work. Nothing in the Contract is intended to create a partnership, a joint venture or an agency between Canada and the other Party or Parties. The Contractor must not represent itself as an agent or representative of Canada to anyone. Neither the Contractor nor any of its personnel is engaged as an employee or agent of Canada. The Contractor is responsible for all deductions and remittances required by law in relation to its employees.



2035 04 (2008-05-12) Conduct of the Work

1. The Contractor represents and warrants that:
 - (a) it is competent to perform the Work;
 - (b) it has everything necessary to perform the Work, including the resources, facilities, labour, technology, equipment, and materials; and
 - (c) it has the necessary qualifications, including knowledge, skill, know-how and experience, and the ability to use them effectively to perform the Work.
2. The Contractor must:
 - (a) perform the Work diligently and efficiently;
 - (b) except for Government Property, supply everything necessary to perform the Work;
 - (c) use, as a minimum, quality assurance procedures, inspections and controls generally used and recognized by the industry to ensure the degree of quality required by the Contract;
 - (d) select and employ a sufficient number of qualified people;
 - (e) perform the Work in accordance with standards of quality acceptable to Canada and in full conformity with the Specifications and all the requirements of the Contract;
 - (f) provide effective and efficient supervision to ensure that the quality of workmanship meets the requirements of the Contract.
3. The Work must not be performed by any person who, in the opinion of Canada, is incompetent, unsuitable or has been conducting himself/herself improperly.
4. All services rendered under the Contract must, at the time of acceptance, be free from defects in workmanship and conform to the requirements of the Contract. If the Contractor is required to correct or replace the Work or any part of the Work, it will be at no cost to Canada.
5. Canada's facilities, equipment and personnel are not available to the Contractor to perform the Work unless the Contract specifically provides for it. The Contractor is responsible for advising the Contracting Authority in advance if it requires access to Canada's facilities, equipment or personnel to perform the Work. The Contractor must comply and ensure that its employees and subcontractors comply with all security measures, standing orders, policies or other rules in force at the site where the Work is performed.
6. Unless the Contracting Authority orders the Contractor to suspend the Work or part of the Work pursuant to section 27, the Contractor must not stop or suspend the Work or part of the Work pending the settlement of any dispute between the Parties about the Contract.
7. The Contractor must provide all reports that are required by the Contract and any other information that Canada may reasonably require from time to time.



8. The Contractor is fully responsible for performing the Work. Canada will not be responsible for any negative consequences or extra costs if the Contractor follows any advice given by Canada unless the Contracting Authority provides the advice to the Contractor in writing and includes a statement specifically relieving the Contractor of any responsibility for negative consequences or extra costs that might result from following the advice.

2035 05 (2010-01-11) Subcontracts

1. Except as provided in subsection 2, the Contractor must obtain the Contracting Authority's written consent before subcontracting or permitting the subcontracting of any part of the Work. A subcontract includes a contract entered into by any subcontractor at any tier to perform any part of the Work.
2. The Contractor is not required to obtain consent for subcontracts specifically authorized in the Contract. The Contractor may also without the consent of the Contracting Authority:
 - (a) purchase "off-the-shelf" items and any standard articles and materials that are ordinarily produced by manufacturers in the normal course of business;
 - (b) subcontract any portion of the Work as is customary in the carrying out of similar contracts; and;
 - (c) permit its subcontractors at any tier to make purchases or subcontract as permitted in paragraphs (a) and (b).
3. In any subcontract other than a subcontract referred to in paragraph 2.(a), the Contractor must, unless the Contracting Authority agrees in writing, ensure that the subcontractor is bound by conditions compatible with and, in the opinion of the Contracting Authority, not less favourable to Canada than the conditions of the Contract.
4. Even if Canada consents to a subcontract, the Contractor is responsible for performing the Contract and Canada is not responsible to any subcontractor. The Contractor is responsible for any matters or things done or provided by any subcontractor under the Contract and for paying any subcontractors for any part of the Work they perform.

2035 06 (2008-05-12) Specifications

1. Specifications provided by Canada or on behalf of Canada to the Contractor in connection with the Contract belong to Canada and must be used by the Contractor only for the purpose of performing the Work.
2. If the Contract provides that Specifications furnished by the Contractor must be approved by Canada, that approval will not relieve the Contractor of its responsibility to meet all requirements of the Contract.

2035 07 (2008-05-12) Replacement of Specific Individuals

1. If specific individuals are identified in the Contract to perform the Work, the Contractor must provide the services of those individuals unless the Contractor is unable to do so for reasons beyond its control.
2. If the Contractor is unable to provide the services of any specific individual identified in the Contract, it must provide a replacement with similar qualifications and experience. The



replacement must meet the criteria used in the selection of the Contractor and be acceptable to Canada. The Contractor must, as soon as possible, give notice to the Contracting Authority of the reason for replacing the individual and provide:

- (a) the name, qualifications and experience of the proposed replacement; and
 - (b) proof that the proposed replacement has the required security clearance granted by Canada, if applicable.
3. The Contractor must not, in any event, allow performance of the Work by unauthorized replacement persons. The Contracting Authority may order that a replacement stop performing the Work. In such a case, the Contractor must immediately comply with the order and secure a further replacement in accordance with subsection 2. The fact that the Contracting Authority does not order that a replacement stop performing the Work does not relieve the Contractor from its responsibility to meet the requirements of the Contract.

2035 08 (2008-05-12) Time of the Essence

It is essential that the Work be performed within or at the time stated in the Contract.

2035 09 (2008-05-12) Excusable Delay

1. A delay in the performance by the Contractor of any obligation under the Contract that is caused by an event that
 - (a) is beyond the reasonable control of the Contractor,
 - (b) could not reasonably have been foreseen,
 - (c) could not reasonably have been prevented by means reasonably available to the Contractor, and
 - (d) occurred without the fault or neglect of the Contractor,

will be considered an "Excusable Delay" if the Contractor advises the Contracting Authority of the occurrence of the delay or of the likelihood of the delay as soon as the Contractor becomes aware of it. The Contractor must also advise the Contracting Authority, within fifteen (15) working days, of all the circumstances relating to the delay and provide to the Contracting Authority for approval a clear work around plan explaining in detail the steps that the Contractor proposes to take in order to minimize the impact of the event causing the delay.

2. Any delivery date or other date that is directly affected by an Excusable Delay will be postponed for a reasonable time that will not exceed the duration of the Excusable Delay.
3. However, if an Excusable Delay has continued for thirty (30) days or more, the Contracting Authority may, by giving notice in writing to the Contractor, terminate the Contract. In such a case, the Parties agree that neither will make any claim against the other for damages, costs, expected profits or any other loss arising out of the termination or the event that contributed to the Excusable Delay. The Contractor agrees to repay immediately to Canada the portion of any advance payment that is unliquidated at the date of the termination.



4. Unless Canada has caused the delay by failing to meet an obligation under the Contract, Canada will not be responsible for any costs incurred by the Contractor or any of its subcontractors or agents as a result of an Excusable Delay.
5. If the Contract is terminated under this section, the Contracting Authority may require the Contractor to deliver to Canada, in the manner and to the extent directed by the Contracting Authority, any completed parts of the Work not delivered and accepted before the termination and anything that the Contractor has acquired or produced specifically to perform the Contract. Canada will pay the Contractor:
 - (a) the value, of all completed parts of the Work delivered to and accepted by Canada, based on the Contract Price, including the proportionate part of the Contractor's profit or fee included in the Contract Price; and
 - (b) the Cost to the Contractor that Canada considers reasonable in respect of anything else delivered to and accepted by Canada.

The total amount paid by Canada under the Contract to the date of termination and any amounts payable under this subsection must not exceed the Contract Price.

2035 10 (2008-05-12) Inspection and Acceptance of the Work

1. All the Work is subject to inspection and acceptance by Canada. Inspection and acceptance of the Work by Canada do not relieve the Contractor of its responsibility for defects or other failures to meet the requirements of the Contract. Canada will have the right to reject any Work that is not in accordance with the requirements of the Contract and require its correction or replacement at the Contractor's expense.
2. The Contractor must provide representatives of Canada access to all locations where any part of the Work is being performed at any time during working hours. Representatives of Canada may make examinations and such tests of the Work as they may think fit. The Contractor must provide all assistance and facilities, test pieces, samples and documentation that the representatives of Canada may reasonably require for the carrying out of the inspection. The Contractor must forward such test pieces and samples to such person or location as Canada specifies.
3. The Contractor must inspect and approve any part of the Work before submitting it for acceptance or delivering it to Canada. The Contractor must keep accurate and complete inspection records that must be made available to Canada on request. Representatives of Canada may make copies and take extracts of the records during the performance of the Contract and for up to three (3) years after the end of the Contract.

2035 11 (2008-05-12) Invoice Submission

1. Invoices must be submitted in the Contractor's name. The Contractor must submit invoices for each delivery or shipment; invoices must only apply to the Contract. Each invoice must indicate whether it covers partial or final delivery.
2. Invoices must show:
 - (a) the date, the name and address of the client, item or reference numbers, deliverable and/or description of the Work, contract number, GST/HST number;



- (b) details of expenditures in accordance with the Basis of Payment, exclusive of Goods and Services Tax (GST) or Harmonized Sales Tax (HST) (such as item, quantity, unit of issue, unit price, fixed time labour rates and level of effort, subcontracts, as applicable);
 - (c) deduction for holdback, if applicable;
 - (d) the extension of the totals, if applicable; and
 - (e) if applicable, the method of shipment together with date, case numbers and part or reference numbers, shipment charges and any other additional charges.
3. If applicable, the GST or HST must be specified on all invoices as a separate item. All items that are zero-rated, exempt or to which the GST or HST does not apply, must be identified as such on all invoices.
4. By submitting an invoice, the Contractor certifies that the invoice is consistent with the Work delivered and is in accordance with the Contract.

2035 12 (2010-08-16) Taxes

1. Municipal Taxes

Municipal Taxes do not apply.

2. Provincial Taxes

- (a) Excluding legislated exceptions, federal government departments and agencies are not required to pay any sales tax payable to the province in which the taxable goods or services are delivered. This exemption has been provided to federal government departments and agencies under the authority of one of the following:
 - (i) Provincial Sales Tax (PST) Exemption Licence Numbers, for the provinces of:
Prince Edward Island OP-10000-250
Manitoba 390-516-0
 - (ii) for Quebec, Saskatchewan, the Yukon Territory, the Northwest Territories and Nunavut, an Exemption Certification, which certifies that the goods or services purchased are not subject to the provincial/territorial sales and consumption taxes because they are purchased by the federal government with Canada funds for the use of the federal government.
- (b) Currently, in Alberta, the Yukon Territory, the Northwest Territories and Nunavut, there is no general PST. However, if a PST is introduced in Alberta, the Yukon Territory, the Northwest Territories or Nunavut, the sales tax exemption certificate would be required on the purchasing document.
- (c) Federal departments must pay the HST in the participating provinces of Newfoundland and Labrador, Nova Scotia, New Brunswick, Ontario and British Columbia.
- (d) The Contractor is not exempt from paying PST under the above Exemption Licence Numbers or Exemption Certification. The Contractor must pay the PST on taxable goods or services used or consumed in the performance of the Contract (in accordance with applicable provincial legislation), including material incorporated into real property.



3. Changes to Taxes and Duties

If there is any change to any tax or duty payable to any level of government in Canada after the bid submission date that affects the costs of the Work to the Contractor, the Contract Price will be adjusted to reflect the increase or decrease in the cost to the Contractor. However, there will be no adjustment for any change that increases the cost of the Work to the Contractor if public notice of the change was given before bid submission date in sufficient detail to have permitted the Contractor to calculate the effect of the change on its cost. There will be no adjustment if the change takes effect after the date required by the Contract for delivery of the Work.

4. GST or HST

The estimated GST or HST, if applicable, is included in the total estimated cost on page 1 of the Contract. The GST or HST is not included in the Contract Price but will be paid by Canada as provided in the Invoice Submission section above. The Contractor agrees to remit to Canada Revenue Agency any amounts of GST and HST paid or due.

5. Tax Withholding of 15 Percent

Pursuant to the *Income Tax Act*, 1985, c. 1 (5th Supp.) and the *Income Tax Regulations*, Canada must withhold 15 percent of the amount to be paid to the Contractor in respect of services provided in Canada if the Contractor is a non-resident unless the Contractor obtains a valid waiver. The amount withheld will be held on account for the Contractor in respect to any tax liability which may be owed to Canada.

2035 13 (2010-01-11) Transportation Costs

If transportation costs are payable by Canada under the Contract and the Contractor makes the transportation arrangements, shipments must be made by the most direct and economical means consistent with normal shipping practice. The costs must be shown as a separate item on the invoice.

2035 14 (2010-01-11) Transportation Carriers' Liability

The federal government's policy of underwriting its own risks precludes payment of insurance or valuation charges for transportation beyond the point at which ownership of goods passes to the federal government (determined by the FOB point or Incoterms). Where increased carrier liability is available without charge, the Contractor must obtain the increased liability for shipment.

2035 15 (2008-05-12) Payment Period

1. Canada's standard payment period is thirty (30) days. The payment period is measured from the date an invoice in acceptable form and content is received in accordance with the Contract or the date the Work is delivered in acceptable condition as required in the Contract, whichever is later. A payment is considered overdue on the 31st day following that date and interest will be paid automatically in accordance with the section 16.
2. If the content of the invoice and its substantiating documentation are not in accordance with the Contract or the Work is not in acceptable condition, Canada will notify the Contractor within fifteen (15) days of receipt. The 30-day payment period begins upon receipt of the revised invoice or the replacement or corrected Work. Failure by Canada to notify the



Contractor within fifteen (15) days will only result in the date specified in subsection 1 to apply for the sole purpose of calculating interest on overdue accounts.

2035 16 (2008-12-12) Interest on Overdue Accounts

1. For the purpose of this section:

"Average Rate" means the simple arithmetic mean of the Bank Rates in effect at 4:00 p.m. Eastern Time each day during the calendar month immediately before the calendar month in which payment is made;

"Bank Rate" means the rate of interest established from time to time by the Bank of Canada as the minimum rate at which the Bank of Canada makes short term advances to members of the Canadian Payments Association;

"date of payment" means the date of the negotiable instrument drawn by the Receiver General for Canada to pay any amount under the Contract;

an amount becomes "overdue" when it is unpaid on the first day following the day on which it is due and payable according to the Contract.

2. Canada will pay to the Contractor simple interest at the Average Rate plus 3 percent per year on any amount that is overdue, from the date that amount becomes overdue until the day before the date of payment, inclusive. The Contractor is not required to provide notice to Canada for interest to be payable.
3. Canada will pay interest in accordance with this section only if Canada is responsible for the delay in paying the Contractor. Canada will not pay interest on overdue advance payments.

2035 17 (2008-05-12) Compliance with Applicable Laws

1. The Contractor must comply with all laws applicable to the performance of the Contract. The Contractor must provide evidence of compliance with such laws to Canada at such times as Canada may reasonably request.
2. The Contractor must obtain and maintain at its own cost all permits, licenses, regulatory approvals and certificates required to perform the Work. If requested by the Contracting Authority, the Contractor must provide a copy of any required permit, license, regulatory approvals or certificate to Canada.

2035 18 (2008-05-12) Ownership

1. Unless provided otherwise in the Contract, the Work or any part of the Work belongs to Canada after delivery and acceptance by or on behalf of Canada.
2. However if any payment is made to the Contractor for or on account of any Work, either by way of progress or milestone payments, that work paid for by Canada belongs to Canada upon such payment being made. This transfer of ownership does not constitute acceptance by Canada of the Work or any part of the Work and does not relieve the Contractor of its obligation to perform the Work in accordance with the Contract.
3. Despite any transfer of ownership, the Contractor is responsible for any loss or damage to the Work or any part of the Work until it is delivered to Canada in accordance with the



Contract. Even after delivery, the Contractor remains responsible for any loss or damage to any part of the Work caused by the Contractor or any subcontractor.

4. Upon transfer of ownership to the Work or any part of the Work to Canada, the Contractor must, if requested by Canada, establish to Canada's satisfaction that the title is free and clear of all claims, liens, attachments, charges or encumbrances. The Contractor must execute any conveyances and other instruments necessary to perfect the title that Canada may require.

2035 19 (2008-05-12) Copyright

In this section, "Material" means anything that is created by the Contractor as part of the Work under the Contract, that is required by the Contract to be delivered to Canada and in which copyright subsists. "Material" does not include anything created by the Contractor before the date of the Contract.

Copyright in the Material belongs to Canada and the Contractor must include the copyright symbol and either of the following notice on the Material: © Her Majesty the Queen in right of Canada (year) or © Sa Majesté la Reine du chef du Canada (année).

The Contractor must not use, copy, divulge or publish any Material except as is necessary to perform the Contract. The Contractor must execute any conveyance and other documents relating to copyright in the Material as Canada may require.

The Contractor must provide at the request of Canada a written permanent waiver of moral rights, in a form acceptable to Canada, from every author that contributed to the Material. If the Contractor is the author of the Material, the Contractor permanently waives its moral rights in the Material.

2035 20 (2008-05-12) Translation of Documentation

The Contractor agrees that Canada may translate in the other official language any documentation delivered to Canada by the Contractor that does not belong to Canada under section 20. The Contractor acknowledges that Canada owns the translation and that it is under no obligation to provide any translation to the Contractor. Canada agrees that any translation must include any copyright notice and any proprietary right notice that was part of the original. Canada acknowledges that the Contractor is not responsible for any technical errors or other problems that may arise as a result of the translation.

2035 21 (2008-05-12) Confidentiality

1. The Contractor must keep confidential all information provided to the Contractor by or on behalf of Canada in connection with the Work, including any information that is confidential or proprietary to third parties, and all information conceived, developed or produced by the Contractor as part of the Work when copyright or any other intellectual property rights in such information belongs to Canada under the Contract. The Contractor must not disclose any such information without the written permission of Canada. The Contractor may disclose to a subcontractor any information necessary to perform the subcontract as long as the subcontractor agrees to keep the information confidential and that it will be used only to perform the subcontract.
2. The Contractor agrees to use any information provided to the Contractor by or on behalf of Canada only for the purpose of the Contract. The Contractor acknowledges that all this



information remains the property of Canada or the third party, as the case may be. Unless provided otherwise in the Contract, the Contractor must deliver to Canada all such information, together with every copy, draft, working paper and note that contains such information, upon completion or termination of the Contract or at such earlier time as Canada may require.

3. Subject to the *Access to Information Act*, R.S., 1985, c. A-1, and to any right of Canada under the Contract to release or disclose, Canada must not release or disclose outside the Government of Canada any information delivered to Canada under the Contract that is proprietary to the Contractor or a subcontractor.
4. The obligations of the Parties set out in this section do not apply to any information if the information:
 - (a) is publicly available from a source other than the other Party; or
 - (b) is or becomes known to a Party from a source other than the other Party, except any source that is known to be under an obligation to the other Party not to disclose the information; or
 - (c) is developed by a Party without use of the information of the other Party.
5. Wherever possible, the Contractor must mark or identify any proprietary information delivered to Canada under the Contract as "Property of (Contractor's name), permitted Government uses defined under National Research Council Canada (NRC) Contract No. (fill in Contract Number)". Canada will not be liable for any unauthorized use or disclosure of information that could have been so marked or identified and was not.
6. If the Contract, the Work, or any information referred to in subsection 1 is identified as TOP SECRET, SECRET, CONFIDENTIAL, or PROTECTED by Canada, the Contractor must at all times take all measures reasonably necessary for the safeguarding of the material so identified, including those set out in the PWGSC Industrial Security Manual and its supplements and any other instructions issued by Canada.
7. If the Contract, the Work, or any information referred to in subsection 1 is identified as TOP SECRET, SECRET, CONFIDENTIAL, or PROTECTED, by Canada, representatives of Canada are entitled to inspect the Contractor's premises and the premises of a subcontractor at any tier for security purposes at any time during the term of the Contract. The Contractor must comply with, and ensure that any subcontractor complies with, all written instructions issued by Canada dealing with the material so identified, including any requirement that employees of the Contractor or of any subcontractor execute and deliver declarations relating to reliability screenings, security clearances and other procedures.
8. The Contractor consents in the case of a contract that has a value in excess of \$10,000.00 to the public disclosure of information – other than information described in any of paragraphs 20(1)a) to (d) of the Access to Information Act – relating to the contract.

2035 22 (2008-05-12) Government Property

1. All Government Property must be used by the Contractor solely for the purpose of the Contract and remains the property of Canada. The Contractor must maintain adequate accounting records of all Government Property and, whenever feasible, mark it as being the property of Canada.



2. The Contractor must take reasonable and proper care of all Government Property while it is in its possession or subject to its control. The Contractor is responsible for any loss or damage resulting from its failure to do so other than loss or damage caused by ordinary wear and tear.
3. All Government Property, unless it is installed or incorporated in the Work, must be returned to Canada on demand. All scrap and all waste materials, articles or things that are Government Property must, unless provided otherwise in the Contract, remain the property of Canada and must be disposed of only as directed by Canada.
4. At the time of completion of the Contract, and if requested by the Contracting Authority, the Contractor must provide to Canada an inventory of all Government Property relating to the Contract.

2035 23 (2008-05-12) Liability

The Contractor is liable for any damage caused by the Contractor, its employees, subcontractors, or agents to Canada or any third party. Canada is liable for any damage caused by Canada, its employees or agents to the Contractor or any third party. The Parties agree that no limitation of liability or indemnity provision applies to the Contract unless it is specifically incorporated in full text in the Articles of Agreement. Damage includes any injury to persons (including injury resulting in death) or loss of or damage to property (including real property) caused as a result of or during the performance of the Contract.

2035 24 (2008-05-12) Intellectual Property Infringement and Royalties

1. The Contractor represents and warrants that, to the best of its knowledge, neither it nor Canada will infringe any third party's intellectual property rights in performing or using the Work, and that Canada will have no obligation to pay royalties of any kind to anyone in connection with the Work.
2. If anyone makes a claim against Canada or the Contractor concerning intellectual property infringement or royalties related to the Work, that Party agrees to notify the other Party in writing immediately. If anyone brings a claim against Canada, according to *Department of Justice Act*, R.S., 1985, c. J-2, the Attorney General of Canada must have the regulation and conduct of all litigation for or against Canada, but the Attorney General may request that the Contractor defend Canada against the claim. In either case, the Contractor agrees to participate fully in the defence and any settlement negotiations and to pay all costs, damages and legal costs incurred or payable as a result of the claim, including the amount of any settlement. Both Parties agree not to settle any claim unless the other Party first approves the settlement in writing.
3. The Contractor has no obligation regarding claims that were only made because:
 - (a) Canada modified the Work or part of the Work without the Contractor's consent or used the Work or part of the Work without following a requirement of the Contract; or
 - (b) Canada used the Work or part of the Work with a product that the Contractor did not supply under the Contract (unless that use is described in the Contract or the manufacturer's specifications); or



- (c) the Contractor used equipment, drawings, specifications or other information supplied to the Contractor by Canada (or by someone authorized by Canada); or
 - (d) the Contractor used a specific item of equipment or software that it obtained because of specific instructions from the Contracting Authority; however, this exception only applies if the Contractor has included the following language in its own contract with the supplier of that equipment or software: "[Supplier name] acknowledges that the purchased items will be used by the Government of Canada. If a third party claims that equipment or software supplied under this contract infringes any intellectual property right, [supplier name], if requested to do so by either [Contractor name] or Canada, will defend both [Contractor name] and Canada against that claim at its own expense and will pay all costs, damages and legal fees payable as a result of that infringement. "Obtaining this protection from the supplier is the Contractor's responsibility and, if the Contractor does not do so, it will be responsible to Canada for the claim.
4. If anyone claims that, as a result of the Work, the Contractor or Canada is infringing its intellectual property rights, the Contractor must immediately do one of the following:
- (a) take whatever steps are necessary to allow Canada to continue to use the allegedly infringing part of the Work; or
 - (b) modify or replace the Work to avoid intellectual property infringement, while ensuring that the Work continues to meet all the requirements of the Contract; or
 - (c) take back the Work and refund any part of the Contract Price that Canada has already paid.

If the Contractor determines that none of these alternatives can reasonably be achieved, or if the Contractor fails to take any of these steps within a reasonable amount of time, Canada may choose either to require the Contractor to do (c), or to take whatever steps are necessary to acquire the rights to use the allegedly infringing part(s) of the Work itself, in which case the Contractor must reimburse Canada for all the costs it incurs to do so.

2035 25 (2008-05-12) Amendment and Waivers

1. To be effective, any amendment to the Contract must be done in writing by the Contracting Authority and the authorized representative of the Contractor.
2. While the Contractor may discuss any proposed modifications to the Work with other representatives of Canada, Canada will not be responsible for the cost of any modification unless it has been incorporated into the Contract in accordance with subsection 1.
3. A waiver will only be valid, binding or affect the rights of the Parties if it is made in writing by, in the case of a waiver by Canada, the Contracting Authority and, in the case of a waiver by the Contractor, the authorized representative of the Contractor.
4. The waiver by a Party of a breach of any condition of the Contract will not be treated or interpreted as a waiver of any subsequent breach and therefore will not prevent that Party from enforcing of that term or condition in the case of a subsequent breach.

2035 26 (2008-05-12) Assignment



1. The Contractor must not assign the Contract without first obtaining the written consent of the Contracting Authority. Any assignment made without that consent is void and will have no effect. The assignment will be effective upon execution of an assignment agreement signed by the Parties and the assignee.
2. Assignment of the Contract does not relieve the Contractor from any obligation under the Contract and it does not impose any liability upon Canada.

2035 27 (2008-05-12) Suspension of the Work

1. The Contracting Authority may at any time, by written notice, order the Contractor to suspend or stop the Work or part of the Work under the Contract for a period of up to one hundred eighty (180) days. The Contractor must immediately comply with any such order in a way that minimizes the cost of doing so. While such an order is in effect, the Contractor must not remove any part of the Work from any premises without first obtaining the written consent of the Contracting Authority. Within these one hundred eighty (180) days, the Contracting Authority must either cancel the order or terminate the Contract, in whole or in part, under section 28 or section 29.
2. When an order is made under subsection 1, unless the Contracting Authority terminates the Contract by reason of default by the Contractor or the Contractor abandons the Contract, the Contractor will be entitled to be paid its additional costs incurred as a result of the suspension plus a fair and reasonable profit.
3. When an order made under subsection 1 is cancelled, the Contractor must resume work in accordance with the Contract as soon as practicable. If the suspension has affected the Contractor's ability to meet any delivery date under the Contract, the date for performing the part of the Work affected by the suspension will be extended for a period equal to the period of suspension plus a period, if any, that in the opinion of the Contracting Authority, following consultation with the Contractor, is necessary for the Contractor to resume the Work. Any equitable adjustments will be made as necessary to any affected conditions of the Contract.

2035 28 (2008-05-12) Default by the Contractor

1. If the Contractor is in default in carrying out any of its obligations under the Contract, the Contracting Authority may, by giving written notice to the Contractor, terminate for default the Contract or part of the Contract. The termination will take effect immediately or at the expiration of a cure period specified in the notice, if the Contractor has not cured the default to the satisfaction of the Contracting Authority within that cure period.
2. If the Contractor becomes bankrupt or insolvent, makes an assignment for the benefit of creditors, or takes the benefit of any statute relating to bankrupt or insolvent debtors, or if a receiver is appointed under a debt instrument or a receiving order is made against the Contractor, or an order is made or a resolution passed for the dissolution, liquidation or winding-up of the Contractor, the Contracting Authority may, to the extent permitted by the laws of Canada, by giving written notice to the Contractor, immediately terminate for default the Contract or part of the Contract.
3. If Canada gives notice under subsection 1 or 2, the Contractor will have no claim for further payment except as provided in this section. The Contractor will be liable to Canada for all losses and damages suffered by Canada because of the default or occurrence upon which the notice was based, including any increase in the cost incurred by Canada in procuring the



Work from another source. The Contractor agrees to repay immediately to Canada the portion of any advance payment that is unliquidated at the date of the termination.

4. Upon termination of the Contract under this section, the Contracting Authority may require the Contractor to deliver to Canada, in the manner and to the extent directed by the Contracting Authority, any completed parts of the Work, not delivered and accepted before the termination and anything the Contractor has acquired or produced specifically to perform the Contract. In such a case, subject to the deduction of any claim that Canada may have against the Contractor arising under the Contract or out of the termination, Canada will pay or credit to the Contractor:
 - (a) the value, of all completed parts of the Work delivered to and accepted by Canada, based on the Contract Price, including the proportionate part of the Contractor's profit or fee included in the Contract Price; and
 - (b) the cost to the Contractor that Canada considers reasonable in respect of anything else delivered to and accepted by Canada.

The total amount paid by Canada under the Contract to the date of the termination and any amount payable under this subsection must not exceed the Contract Price.

5. Title to everything for which payment is made to the Contractor will, once payment is made, pass to Canada unless it already belongs to Canada under any other provision of the Contract.
6. If the Contract is terminated for default under subsection 1, but it is later determined that grounds did not exist for a termination for default, the notice will be considered a notice of termination for convenience issued under subsection 1 of section 29.

2035 29 (2008-05-12) Termination for Convenience

1. At any time before the completion of the Work, the Contracting Authority may, by giving notice in writing to the Contractor, terminate for convenience the Contract or part of the Contract. Once such a notice of termination for convenience is given, the Contractor must comply with the requirements of the termination notice. If the Contract is terminated in part only, the Contractor must proceed to complete any part of the Work that is not affected by the termination notice. The termination will take effect immediately or, as the case may be, at the time specified in the termination notice.
2. If a termination notice is given pursuant to subsection 1, the Contractor will be entitled to be paid, for costs that have been reasonably and properly incurred to perform the Contract to the extent that the Contractor has not already been paid or reimbursed by Canada. The Contractor will be paid:
 - (a) on the basis of the Contract Price, for all completed work that is inspected and accepted in accordance with the Contract, whether completed before, or after the termination in accordance with the instructions contained in the termination notice;
 - (b) the Cost to the Contractor plus a fair and reasonable profit for all work terminated by the termination notice before completion; and



- (c) all costs incidental to the termination of the Work incurred by the Contractor but not including the cost of severance payments or damages to employees whose services are no longer required, except wages that the Contractor is obligated by statute to pay.
3. Canada may reduce the payment in respect of any part of the Work, if upon inspection, it does not meet the requirements of the Contract.
4. The total of the amounts, to which the Contractor is entitled to be paid under this section, together with any amounts paid, due or becoming due to the Contractor must not exceed the Contract Price. The Contractor will have no claim for damages, compensation, loss of profit, allowance arising out of any termination notice given by Canada under this section except to the extent that this section expressly provides. The Contractor agrees to repay immediately to Canada the portion of any advance payment that is unliquidated at the date of the termination.

2035 30 (2008-05-12) Accounts and Audit

1. The Contractor must keep proper accounts and records of the cost of performing the Work and of all expenditures or commitments made by the Contractor in connection with the Work, including all invoices, receipts and vouchers. The Contractor must retain records, including bills of lading and other evidence of transportation or delivery, for all deliveries made under the Contract.
2. If the Contract includes payment for time spent by the Contractor, its employees, representatives, agents or subcontractors performing the Work, the Contractor must keep a record of the actual time spent each day by each individual performing any part of the Work.
3. Unless Canada has consented in writing to its disposal, the Contractor must retain all the information described in this section for six (6) years after it receives the final payment under the Contract, or until the settlement of all outstanding claims and disputes, whichever is later. During this time, the Contractor must make this information available for audit, inspection and examination by the representatives of Canada, who may make copies and take extracts. The Contractor must provide all reasonably required facilities for any audit and inspection and must furnish all the information as the representatives of Canada may from time to time require to perform a complete audit of the Contract.
4. The amount claimed under the contract, calculated in accordance with the Basis of Payment provision in the Articles of Agreement, is subject to government audit both before and after payment is made. If an audit is performed after payment, the Contractor agrees to repay any overpayment immediately on demand by Canada. Canada may hold back, deduct and set off any credits owing and unpaid under this section from any money that Canada owes to the Contractor at any time (including under other contracts). If Canada does not choose to exercise this right at any given time, Canada does not lose this right.

2035 31 (2008-05-12) Right of Set-off

Without restricting any right of set-off given by law, Canada may set-off against any amount payable to the Contractor under the Contract, any amount payable to Canada by the Contractor under the Contract or under any other current contract. Canada may, when making a payment pursuant to the Contract, deduct from the amount payable to the Contractor any such amount payable to Canada by the Contractor which, by virtue of the right of set-off, may be retained by Canada.



2035 32 (2008-05-12) Notice

Any notice under the Contract must be in writing and may be delivered by and, courier, mail, facsimile or other electronic method that provides a paper record of the text of the notice. It must be sent to the Party for whom it is intended at the address stated in the Contract. Any notice will be effective on the day it is received at that address. Any notice to Canada must be delivered to the Contracting Authority.

2035 33 (2008-05-12) Conflict of Interest and Values and Ethics Codes for the Public Service

The Contractor acknowledges that individuals who are subject to the provisions of the *Conflict of Interest Act*, 2006, c. 9, s. 2, the Conflict of Interest Code for Members of the House of Commons, the Values and Ethics Code for the Public Service or all other codes of values and ethics applicable within specific organizations cannot derive any direct benefit resulting from the Contract.

2035 34 (2008-05-12) No Bribe or Conflict

1. The Contractor declares that no bribe, gift, benefit, or other Inducement has been or will be paid, given, promised or offered directly or indirectly to any official or employee of Canada or to a member of the family of such a person, with a view to influencing the entry into the Contract or the administration of the Contract.
2. The Contractor must not influence, seek to influence or otherwise take part in a decision of Canada knowing that the decision might further its private interest. The Contractor must have no financial interest in the business of a third party that causes or would appear to cause a conflict of interest in connection with the performance of its obligations under the Contract. If such a financial interest is acquired during the period of the Contract, the Contractor must immediately declare it to the Contracting Authority.
3. The Contractor warrants that, to the best of its knowledge after making diligent inquiry, no conflict exists or is likely to arise in the performance of the Contract. In the event the Contractor becomes aware of any matter that causes or is likely to cause a conflict in relation to the Contractor's performance under the Contract, the Contractor must immediately disclose such matter to the Contracting Authority in writing.
4. If the Contracting Authority is of the opinion that a conflict exists as a result of the Contractor's disclosure or as a result of any other information brought to the Contracting Authority's attention, the Contracting Authority may require the Contractor to take steps to resolve or otherwise deal with the conflict or, at its entire discretion, terminate the Contract for default. Conflict means any matter, circumstance, interest, or activity affecting the Contractor, its personnel or subcontractors, which may or may appear to impair the ability of the Contractor to perform the Work diligently and independently.

2035 35 (2008-05-12) Survival

All the Parties' obligations of confidentiality, representations and warranties set out in the Contract as well as the provisions, which by the nature of the rights or obligations might reasonably be expected to survive, will survive the expiry or termination of the Contract.

2035 36 (2008-05-12) Severability



If any provision of the Contract is declared by a court of competent jurisdiction to be invalid, illegal or unenforceable, that provision will be removed from the Contract without affecting any other provision of the Contract.

2035 37 (2008-05-12) Successors and Assigns

The Contract is to the benefit of and binds the successors and permitted assignees of Canada and of the Contractor.

2035 38 (2008-12-12) Contingency Fees

The Contractor certifies that it has not directly or indirectly, paid or agreed to pay and agrees that it will not, directly or indirectly, pay a contingency fee for the solicitation, negotiation or obtaining of the Contract to any person, other than an employee of the Contractor acting in the normal course of the employee's duties. In this section, "contingency fee" means any payment or other compensation that depends or is calculated based on a degree of success in soliciting, negotiating or obtaining the Contract and "person" includes any individual who is required to file a return with the registrar pursuant to section 5 of the *Lobbying Act*, 1985, c. 44 (4th Supplement).

2035 39 (2010-01-11) International Sanctions

1. Persons in Canada, and Canadians outside of Canada, are bound by economic sanctions imposed by Canada. As a result, the Government of Canada cannot accept delivery of goods or services that originate, either directly or indirectly, from the countries or persons subject to [economic sanctions](#).
2. The Contractor must not supply to the Government of Canada any goods or services which are subject to economic sanctions.
3. The Contractor must comply with changes to the regulations imposed during the period of the Contract. The Contractor must immediately advise Canada if it is unable to perform the Work as a result of the imposition of economic sanctions against a country or person or the addition of a good or service to the list of sanctioned goods or services. If the Parties cannot agree on a work around plan, the Contract will be terminated for the convenience of Canada in accordance with section 29.

2035 40 (2008-05-12) Harassment in the Workplace

1. The Contractor acknowledges the responsibility of Canada to ensure, for its employees, a healthy work environment, free of harassment. A copy of the [Policy on the Prevention and Resolution of Harassment in the Workplace](#), which is also applicable to the Contractor, is available on the Treasury Board Web site.
2. The Contractor must not, either as an individual, or as a corporate or unincorporated entity, through its employees or subcontractors, harass, abuse, threaten, discriminate against or intimidate any employee, contractor or other individual employed by, or under contract with Canada. The Contractor will be advised in writing of any complaint and will have the right to respond in writing. Upon receipt of the Contractor's response, the Contracting Authority will, at its entire discretion, determine if the complaint is founded and decide on any action to be taken.

2035 41 (2008-05-12) Entire Agreement



The Contract constitutes the entire and only agreement between the Parties and supersedes all previous negotiations, communications and other agreements, whether written or oral, unless they are incorporated by reference in the Contract. There are no terms, covenants, representations, statements or conditions binding on the Parties other than those contained in the Contract.