

APPENDIX A

AMEC Geotechnical Report #TY1230281



**ADDITIONAL GEOTECHNICAL TEST HOLE INVESTIGATION
PROPOSED STRUCTURAL STABILIZATION OF STORES BUILDING
SAULT STE. MARIE, ONTARIO**

Submitted to:

Rowswell and Associates Engineers Inc.

100 Bruce Street
Sault Ste. Marie, ON
P6A 2X5

Submitted by:

**AMEC Environment & Infrastructure,
A Division of AMEC Americas Limited**

131 Fielding Road
Lively, Ontario
P3Y 1L7
(705) 682-2632

11 March 2014

AMEC Project No.: **TY1230281**

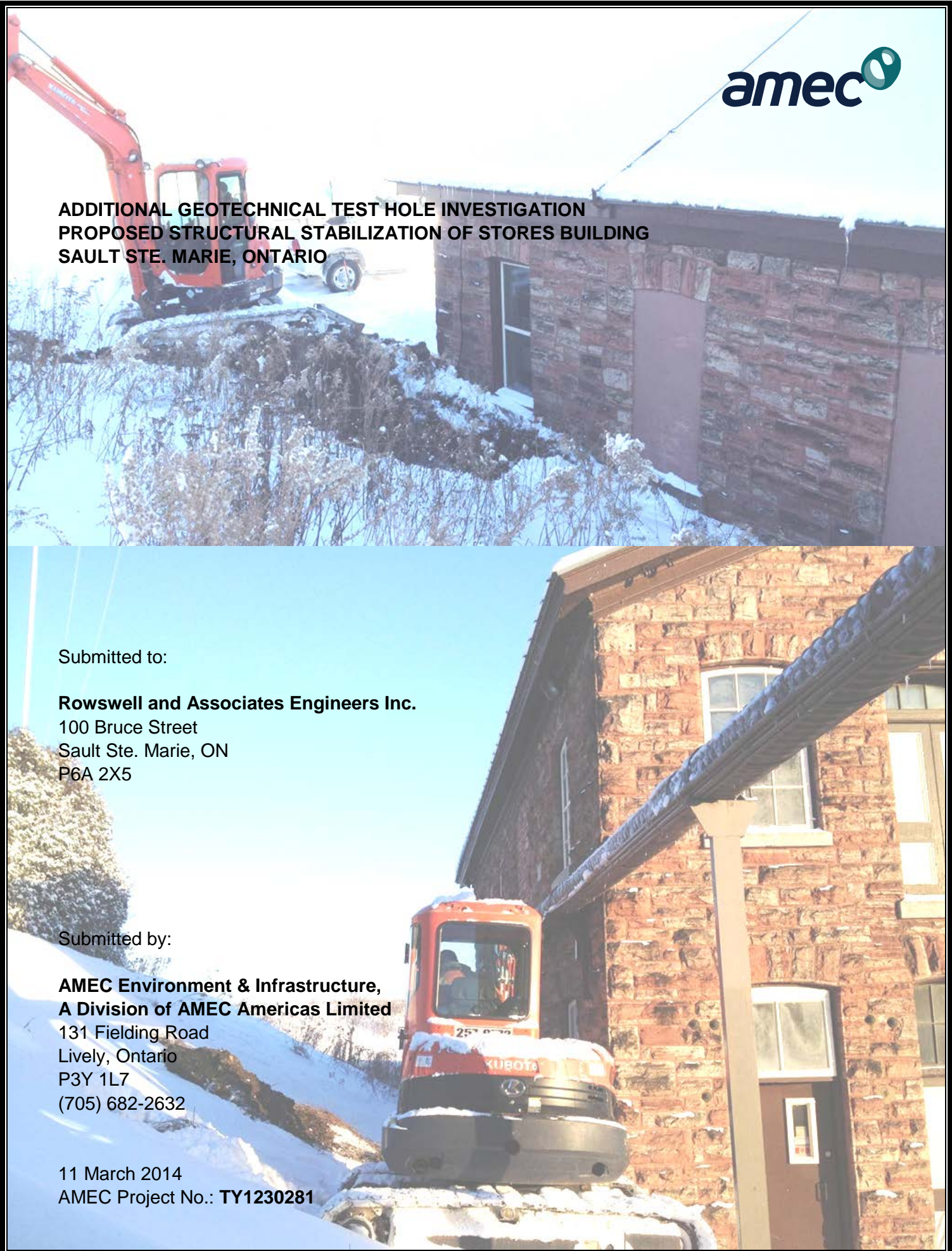

TABLE OF CONTENTS

Section	Page
1.0 INTRODUCTION	1
1.1 Background	1
2.0 GEOLOGICAL SETTING	2
3.0 INVESTIGATION PROGRAM	3
4.0 FIELD CONDITIONS	5
4.1 Surficial Layer	5
4.2 Sand and Gravel.....	6
4.3 Bedrock	6
4.4 Coring	7
4.5 Groundwater.....	8
5.0 GEOTECHNICAL CONCERNS.....	8
5.1 Foundation Walls	9
5.2 Founding Conditions and Supporting Soils.....	9
5.3 Foundation Backfill Material	10
5.4 Groundwater Considerations.....	10
5.5 Excavations.....	11
6.0 GROUTING EVALUATION	12
7.0 FOUNDATIONS TO BEDROCK.....	12
7.1 Micro-Piles.....	12
7.2 Drilled Piles	13
8.0 CLOSURE.....	13
9.0 REFERENCES	15

Explanation of Borehole Log

Modified Unified Classification System for Soils

LIST OF TABLES

Table 1 – Test Pit Data.....	5
------------------------------	---

LIST OF FIGURES

Figure 1	Site Location Map
Figure 2	Test Hole Location Plan
Figure 3	Foundation and Test Pit Details
Figure 4	Grain Size Distribution Analysis – TP13-04 Grab Sample 2
Figure 5	Grain Size Distribution Analysis – TP13-03 Grab Sample 2
Figure 6	8 Hour Pumping Test at BH13-04 (Discharge vs. Time)
Figure 7	8 Hour Pumping Test at BH13-04 (Displacement vs. Time)
Figure 8	Cooper-Jacob Analysis of Observed Drawdown Data
Figure 9	Theis Analysis of Observed Recovery Data

LIST OF APPENDICES

Appendix A	Previous Geotechnical Report - AMEC
Appendix B	Previous Geotechnical Reports - Geocon
Appendix C	Borehole Logs
Appendix D	Multiurethanes Reports
Appendix E	Limitations of Report

1.0 INTRODUCTION

AMEC Environment & Infrastructure, a Division of AMEC Americas Limited (AMEC), has been retained by Rowswell and Associates Engineers Inc. (Rowswell) to complete an Additional Geotechnical Test Hole Investigation for the Parks Canada Agency's (PCA), as a follow up to the original Request for Proposal 10120583 (RFP), dated 19 September 2012, regarding the structural stabilization of Stores Building in Sault Ste. Marie, Ontario (see Figure 1). Previously, AMEC completed a geotechnical investigation for this same project (original report included in Appendix A), which presented various options to stabilize the foundation of the Stores Building. Rowswell, in consultation with PCA, selected grouting as the preferred option to stabilize the foundation. To ensure grouting is in fact the most suitable option, PCA wanted to reduce the risk of implementing this option by completing an additional geotechnical investigation.

The scope of work for this additional geotechnical investigation also included a hydrogeological analysis, evaluation of a concrete curb within the building, and consultation with a grouting expert.

The purpose of this additional geotechnical investigation was to determine the subsurface conditions and relevant soil properties at a number of test locations in order to augment the subsurface information and develop recommendations for the geotechnical aspects of the proposed repair design.

The anticipated construction conditions are also discussed, but only to the extent that they may influence design decisions. The feasible construction methods, however, express our opinion and are not intended to direct contractors in how to carry out construction. Contractors should also be aware that the data and their interpretation presented in this report may not be sufficient to assess all factors that may have an effect upon construction.

We assume that the work will be carried out in accordance with good engineering practises and all applicable standards and regulations. Environmental considerations were not part of the scope of work for this geotechnical investigation.

There should be an ongoing liaison with AMEC during both the design and construction phases of the project to ensure that the recommendations in this report have been interpreted and implemented correctly. Also, if any further clarification and/or elaboration are needed concerning the geotechnical aspects of this project, AMEC should be contacted immediately.

1.1 Background

Through a review of background information included within the RFP package, AMEC understands that the existing Stores building foundation, built circa 1896, is continuing to undergo duress contributing to the ongoing deterioration of the structure. Previous investigation reports by Geocon Inc. (Geocon), dated September 1984 and November 1985 (included in Appendix B), have suggested that one possible source for the ongoing settlement issue may be related to the flow of water through the existing blast rock fill washing fine soil particles from below the footings.

A Stores building condition assessment (BCA), commissioned by Public Works and Government Services Canada, was issued in December 2010 and indicated the condition of the foundation exposed in a test pit at the south east corner of the building was in very poor condition. A further detailed description of the findings in the test pit, including comments and assessment based on a comprehensive evaluation of the main interacting building components (structure, materials, envelope, site features, etc.) of the entire building condition is provided in the quoted report.

The report went on to suggest that additional geotechnical investigation was required in order to:

1. Confirm the soil / bedrock conditions below the entire building;
2. Monitor foundation movements to determine whether the suspected movement is ongoing;
3. Investigate the source and extent of the groundwater flow;
4. Investigate and confirm the as built condition of the foundation walls; and,
5. Develop feasible options for the stabilization of the foundation.

Based on the Geocon report dated September 1984 (Geocon 1984), in the available background information, the St Mary's Islands was a series of smaller islands joined by infilling gaps with rock blasted from the construction of the locks. It is believed the Stores building was built on fill deposits and has experienced differential movements and cracking of the blocks and mortar. Previous excavations have uncovered voids beneath concrete sidewalks, indicating probable washing away of supporting fill.

Cracking has only been noted in the southern portion of the Stores building, along with differential settlement of the concrete slab adjacent to the Stores building. The adjacent Pumphouse building, thought to be built on bedrock, has not undergone noticeable movements.

During spring thaw, it has also been observed that sink holes form that cause pedestrian hazards. A dye test confirmed a relatively high groundwater flow within the island of 0.05 to 0.1 m/sec.

2.0 GEOLOGICAL SETTING

The primary, surficial geology of the area is glaciolacustrine deposits consisting of either silt and clay, minor sand, basin and quiet water deposits or glaciolacustrine deposits of sand, gravelly sand and gravel, near shore and beach deposits.

The bedrock geology on St. Mary's Island is comprised of Proterozoic-aged Jacobsville Group and Oronto Group sandstone, shale, and conglomerate rocks of the Southern and Superior Provinces.

3.0 INVESTIGATION PROGRAM

The additional fieldwork for this project was carried out on 11 to 16 December 2013, when three (3) sampled boreholes (BH13-04 to 13-06) were advanced adjacent to the building, while two (2) were advanced inside the building (BH13-07 and 08). Two test pits (TP1304 and 05) were also excavated along the west side of the building. All test hole locations are shown on the Test Hole Location Plan (see Figure 2).

BH13-04 was a large 200 mm diameter borehole, advanced with a track mounted soils drill rig and was intended to serve as the pump well for the hydrogeological evaluation. At this location, there was a reinforced concrete slab that required a jack hammer to penetrate, to provide access for the drill augers (see Photo 1, below). The other four sampled boreholes; 2 inside the building and 2 along the slope, west of the building were advanced using hand drilling equipment because of location limitations. The borehole logs are presented in Appendix C. All borehole locations were determined in the field based on a drawing provided to our office.



Photo 1: Jack hammered hole for pump well installation.

The pump well BH13-04 was advanced using hollow stem augers and conventional soil sampling methods. A 150 mm diameter test well was installed to a depth of 4.1 m and equipped with 1.5 m of #10 slot sized screen. The well was installed at the bedrock/overburden interface within a moderately permeable sand and gravel unit with some silt and clay. The location of test well BH13-04 is shown in Figure 2.

After a short resting period to allow the effects of drilling to dissipate a complete set of water level readings was taken prior to initiation of the pump test.

Soil samples were collected at predetermined depth intervals in accordance with Standard Penetration Testing procedures (ASTM D-1586) utilizing a mechanical hammer. The other holes were advanced with hand drilling equipment utilizing core barrels with diamond drill bits because of the numerous cobbles/boulders.

Field drilling observations are recorded on the Borehole Logs (Appendix C), including 'N'-values, where appropriate. These values provide an indication of the various soil strata's condition with respect to compactness or consistency. The samples were field logged by an experienced soil technologist, placed in plastic bags and delivered to our office for further examination and testing.

The boreholes were surveyed by our field staff using a temporary benchmark (garage bay door to the east of the stores building) with an assigned elevation of 100 m. Borehole locations were also geo-referenced to UTM co-ordinates using a portable Global Positioning System (GPS). Elevations and GPS co-ordinates on the borehole logs can be found in Appendix C.

Two test pits (TP13-03 and 04) were excavated along the western wall, at the north and south ends. The test pit data is included in Table 1, with details presented on Figure 3. The test pits were excavated with a small Bobcat machine.



Photo 2: View of TP13-03 excavated at northwest corner of the building. The northern portion of the building does not appear to be moving, so this test pit was for comparative purposes.

Table 1 – Test Pit Data

Test Pit No.	Co-ordinates NAD 86, 16T	Depth (m)	Soil Description and Comments
TP13-03	0703312 E, 5154504 N	0 – 0.33	dark brown FILL, mostly sand, some gravel, trace silt, wet
		0.33 – 0.51	CONCRETE SLAB
		0.51 – 0.81	WATERMAIN (600mm Diameter)
		0.81 – 0.97	black FILL, mostly sand and gravel, trace silt, wet
		0.97 – 1.83	brown / red SAND with GRAVEL, some cobbles, trace silt and clay, moist-wet (water at 1.45 m from grade)
		1.83	END OF TEST PIT
TP13-04	0703300 E, 5154522 N	0 – 0.33	black FILL, mostly sand, some gravel, trace silt and organics, wet
		0.33 – 0.51	CONCRETE SLAB
		0.51 – 0.71	dark brown / black FILL, mostly sand, some gravel, trace silt, wet
		0.71 – 1.83	dark brown / red SAND with GRAVEL, some silt, trace clay, wet (water at 1.12 m from grade)
		1.83	END OF TEST PIT

Additional information was required of the make-up of the foundation wall, so two (CH13-01 and 02) horizontal cores were advanced from within the basement area, outwards through the foundation wall. The holes were advanced in an area where a concrete “curb” had been poured abutting the foundation wall. The curb appears to be some type of buttressing to support the stone foundation wall.

4.0 FIELD CONDITIONS

A summary of the subsurface conditions encountered in the boreholes and test pits are presented below.

4.1 Surficial Layer

The pump well borehole (BH13-04) and the two boreholes advanced through the interior floor slab (BH13-07 and 08) encountered a surficial concrete slab that ranged from 300 to 400 mm in thickness. A concrete slab was also encountered in TP13-03 and 04, buried approximately 0.36 m. Historic drawings indicate buried, abandoned services along the western side of the building and this slab was likely installed to protect the services or to deflect percolating surface water.



Photo 3: View of CH13-01 advanced through foundation wall.

As is the case at this site, concrete slabs and the perimeter of buildings are usually backfilled with granular fill. The fill comprises mostly sand and gravel mixed with varying clay, silt, cobbles, boulders and organics, along with some debris. The fill around the building is not as free draining as it should be. The fill was measured to be between 0.6 to 2.4 m in thickness but is expected to range in thickness and quality across the site. Two grain size distributions of the fill are shown on Figures 4 and 5. It is probable that the fill material was taken from construction activities elsewhere on the island.

4.2 Sand and Gravel

Underlying the fill layer is a red to brown, moist to wet, sand and gravel with some silt and trace clay. This soil layer is moist to wet and compact to dense. It is likely this layer represents a glacial till layer that extends to the bedrock surface.

4.3 Bedrock

Bedrock was encountered and cored in BH13-05 to 08 at depths ranging from 2.4 to 3.7 m below grade. The bedrock coring was extended to between 3.1 and 6.4 m in depth and comprised sandstone that generally increased in quality with depth. Total core recovery (TCR), which is a measurement of how much core was recovered compared to how much was actually cored, ranged from 33 to 100%. Solid core recovery (SCR), which is a measurement of the total length of solid rock core compared to the total length, ranged from 8 to 96%. The Rock Quality Designation (RQD), which is the total length of pieces over 100 mm in length compared to the total length, ranged from 0 to 75%, indicating a very poor to fair rock quality, but generally poor.

4.4 Coring

As indicated earlier, the floor slab and the foundation walls were cored. The basement slab concrete was intact and appears to be in good condition. Understandably, it is bonded to the underlying subsoil, which appear to be absent of fine soils, although they may have been washed away by the water used during coring. As can be seen in Photo 4, it is obvious a new slab has been poured over the original slab. The original slab (the top of the core in the photo) has coarser aggregate and indicative of older standards in concrete manufacturing. The upper, lighter in colour concrete has smaller, more uniform aggregate, typical of good quality concrete.



Photo 4: Core of floor slab.



Photo 5: Core of interior concrete curb and foundation wall.

The cores taken of the foundation wall indicate the concrete curb inside the building is of good quality, but the large aggregate size would indicate it is of an older vintage. The cobbler foundation wall behind the concrete section is difficult to evaluate, however, it should be noted the mortar appeared to be deteriorated, although that may be in part due to the coring procedure and use of water for drilling.

The Stores building foundation contain large pieces of a red to red-brown inter-bedded sandstone characterized by a poorly sorted, clastic texture and random, isolated spherical leached spots (0.2 mm to 7.5 mm in diameter) that appear in sharp contrast. Generally, the grain size ranged from 0.2 mm to 0.6 mm. The composition of the specimens provided for hand sample examination included individual crystal grains of rounded quartz (55% to 60%), individual crystal grains of angular feldspar (25% to 30%), individual crystal grains of angular amphibolites (5% to 10%), and irregular mafic rock types or metallic minerals (3% to 5%).

A series of approximately 11 inter-beds were observed in one specimen. The fine grained (0.05 mm to 0.5 mm) feldspar-rich bedding planes were associated with six open fractures that measured less than 0.1 mm to 0.75 mm were observed at the concrete interface and traversing along these planes of weakness within the sandstone. Overall, the sandstone is of a good quality. When tested with a metal blade the sandstone is hard to medium hard showing high strength with edges and corners able to be plucked with some difficulty.

More detailed composition of the sandstone specimens and micro-fracturing within this sandstone would require detailed thin section examination. This type of rock is typical to the area and should be available from local quarries.

A cross-section of the foundation wall is depicted on Figure 3.

4.5 Groundwater

Groundwater was encountered in all boreholes and test pits on completion and was measured following a period of stabilization in BH13-04 to 06 and 08 on 17 December 2013 to be between 0.8 and 1.4 m below grade. However, in general the water level was observed to be approximately 0.5 to 0.9 m below the top of the Stores building concrete floor slab.

During the test pit excavation, and once a depth of approximately 1 m below the concrete slab was reached, groundwater began to fill the excavation.

It should be noted that water level readings are subject to the local ground water regime and in particular, operations in and around the St. Mary's River. In addition, and as noted during the pump test, the sump pump within the building was observed to lower the water level by as much as 0.6 m outside the building footprint, inside the test well.

5.0 GEOTECHNICAL CONCERNS

Based on the available background information, and previous and current investigations and inspections, several geotechnically related concerns have been identified. They include the following:

1. The actual foundation walls are old and possibly structurally deteriorated by aging and decaying mortar.

2. The founding conditions and supporting soils are variable and possibly deleterious in some areas.
3. Foundation backfill material is variable and deleterious in areas.
4. Groundwater is shallow and flows readily through the area.
5. Groundwater levels may fluctuate considerably over the year.
6. The west foundation wall located along the toe of a slope may be subjected to a lateral unbalanced earth pressure.

5.1 Foundation Walls

The foundation walls are constructed of cobble and boulder sized stones which were originally held together with mortar. The quality of the mortar, the effects of freeze-thaw cycles, poor founding conditions, and probable movement of the foundation walls has resulted in a weakened and deteriorated structure.

The coring was terminated prior to penetrating the exterior building facade and as such, no sample of the facing was collected. However, as noted in Section 4.3 (pg. 16) of the 'Stores Building Condition Assessment', dated December 2010, "The exterior walls are load bearing masonry construction and feature coursed squared rubble sandstone for both the exterior and interior wythes. The sandstone was quarried from the excavation for the canal." The red sandstone observed in the foundation wall and facing is similar to the rock cored at the base of the boreholes.

5.2 Founding Conditions and Supporting Soils

The development of the site, and the backfilling techniques, with varying backfill materials has resulted in variable founding conditions and differing frost susceptibility. Valleys filled with apparently random coarse and fine blast rock have provided erratic groundwater flow paths. Subsequently, these background factors likely have affected the buildings constructed above these materials.

Depending on placement techniques, the blast rock is susceptible to movement through shifting or consolidating due to vibrations, forces from groundwater flow, etc. Placement of materials beside each other that are not filter graded compatible could cause finer soil to flow into voids of adjacent, coarser material, and cause movements/settlement. If foundations were placed on organic soils, these soils may be undergoing decomposition or consolidation. The decomposition and consolidation would be affected by fluctuations in the groundwater level.

No subfloor gaps were encountered in the test holes advanced through the interior concrete slabs, so it is possible the slab is in intimate contact with the supporting soils. A probe hole investigation or geophysical survey could be completed to confirm this assumption. In this light, no remedial actions at this time are required for the interior slabs. The slabs should be monitored during construction and if affected, they may require consideration, which may include pressure grouting of any gaps formed under the slabs, etc.

5.3 Foundation Backfill Material

Similar to the discussions pertaining to the fill material under the foundations, backfill around the foundations is also variable, and contains deleterious or frost susceptible material. Organic or frost susceptible soils used as backfill in direct contact with foundation walls could detrimentally affect drainage and cause frost adhesion to the already weak foundation wall and cause movements.

5.4 Groundwater Considerations

The consistent and steady supply of groundwater actively aggravates problems caused by freeze-thaw of founding and backfill materials. In addition, these movements and fluctuations can help mobilize and transport fine material from their original area of placement.

To aid in deciding if grouting would be a viable option, a pump test was required to establish groundwater conditions and permeability of the underlying soils. Results of the pump-test conducted at the newly installed BH13-04, located adjacent to the Stores Building, were analyzed using the AQTESOLV (version 4.5) software developed by Glenn M. Duffield, HydroSOLVE Inc. (Duffield, 2007).

Test well BH13-04 was pumped at rates ranging from 3 litres per minute (L/min.) to 6.5 L/min. over a period of 9.75 hours on 20 December 2013. Drawdown and recovery data were monitored in the pumped well only.

Pumping rates and observed drawdown measured in the well during the test are shown in Figures 6 and 7, respectively. Maximum drawdown observed in the pumping well was about 2.4 m, after about 6.4 hours of pumping. At the end of pumping, water levels in the pumped well recovered to about 90% of the pre-pumping level after 35 minutes of recovery measurements.

During the course of the pump test, the dewatering sump in the Stores Building was active. Discharge data is not available for this building sump dewatering system but it is inferred that the sump pumping influenced water levels observed within the pumped well, as noted by the changes in water level, which do not align with prescribed changes in pumping rate, i.e., increases in drawdown observed at 100, 150, 240 and 415 min. Due to this, drawdown data after 100 min were not used to estimate transmissivity. Recovery data did not appear to be influenced by the sump pump operation as the sump pump did not cycle on during well recovery, so these data were also used to estimate formation transmissivity.

Cooper-Jacob (1946) solution was used to analyze drawdown observed within the pumped well from 30 min. to 100 min. of the pump test. Early-time data, i.e., prior to 30 min. was excluded from analysis to avoid influence of well bore storage effects. Analysis of the drawdown observed in the test well is shown in Figure 8 and yielded an estimated aquifer transmissivity of $1.2 \times 10^{-5} \text{ m}^2/\text{s}$.

Theis (1935) analysis of recovery observed in BH13-04 after cessation of pumping is shown on Figure 9 and yielded an estimated aquifer transmissivity of $3.8 \times 10^{-6} \text{ m}^2/\text{s}$.

Utilizing a sand thickness of 1.5 m, coinciding with length of well screen, estimated results in hydraulic conductivity are $2.5 \times 10^{-6} \text{ m/s}$ to $8 \times 10^{-6} \text{ m/s}$, with a geometric mean value of $4.5 \times 10^{-6} \text{ m/s}$. 1.5 m was used as the sand thickness, as this represented the minimum saturated thickness of formation over which the estimates were made i.e., data observed when water level was drawn below top of well screen were not used in the analysis.

It should be noted that our estimated hydraulic conductivity are not in line with previous dye test flow results (converted to approximate hydraulic conductivity), which is roughly 3 orders of magnitude different than our pump test results. The dye test was completed before the cut-off wall was installed, and likely represents a preferential (easiest) flow path, possibly through coarse rock fill voids. The pump test results have been determined from a test done within a specific screened section, with a proper sand filter, and installed within the native sand and gravel soils. Water would therefore flow “faster” through blast rock fill, as compared to a “tighter” sand and gravel.

As noted in our original report, it is probable that groundwater flow paths are forcing water beneath the building, within the foundation walls, but is becoming trapped because of lower permeability fill along the downstream walls. Repairs should consider measures to allow for groundwater to flow freely from beneath the building, such as drainage pipes through the foundation wall, etc.

5.5 Excavations

Above the groundwater table, temporary shallow excavations in soil (expected to generally be Type 3 soils) should be stable at 1H: 1V side slopes in accordance with the Ontario Health and Safety Regulations. Seepage from a surface water source should be moderate and if necessary can be handled by gravity drainage and pumping (properly filtered) from open sumps.

However, due to the high groundwater table observed in the test pits (1.1 to 1.5 m below grade), most excavations will likely penetrate the groundwater table and engineered shoring and dewatering will be required.

All excavations should be carried out in accordance with the Occupational Health and Safety Regulations of the province. A qualified geotechnical engineer should be retained to review the proposed excavation procedures.

As a side note, piezometer readings are only valid for the time of year they are read. Typically, to have a thorough understanding of groundwater levels, numerous readings need to be taken throughout various seasons. The readings taken during the two investigation periods may not be entirely representative for the time of year when construction will be undertaken.

Considering the groundwater level was relatively shallow during both investigations that both were conducted during relatively “drier” periods of the year, groundwater rushed quickly into all test pits, and groundwater was being pumped regularly by the sump pump system, it is likely the contractor will be challenged controlling groundwater during repairs. Dewatering and pump water discharge, along with a Permit to Take Water, will require serious considerations. During dewatering, the Stores and surrounding buildings must be monitored for movements.

6.0 GROUTING EVALUATION

As indicated earlier, Rowswell, in consultation with PCA, selected grouting as the preferred option to stabilize the foundation. To ensure grouting is in fact the most suitable option, PCA wanted to reduce the risk of implementing this option by completing an additional geotechnical investigation. As part of this scope of work, a grouting specialist, Multiurethanes were retained to review available reports, supervise this recent investigation and its result and comment on the viability of grouting the native soils. Their report is included in Appendix D. In summary, they feel grouting is not a viable option of the foundations due to the fines content and permeability of the native soils.

7.0 FOUNDATIONS TO BEDROCK

AMEC understands that the current preferred option is grade beams to reinforce the foundation wall and to be supported by piles installed to bedrock. AMEC is in agreement with this option.

The depth to bedrock, as measured in our test holes, ranged from 2.4 to 4.1 m depth below existing grade. Foundation loads will be transferred to bedrock via piles. Support beams or foundation wall reinforcement will be required in conjunction with this option. The reinforced foundation will be tied into foundation elements that will be installed down to the bedrock surface. All foundation to bedrock options will require pre-drilling to penetrate the cobbles/boulder and lined holes, to install the foundation elements.

Foundations directly on the bedrock surface can utilize a conservative bearing capacity of 500 kPa. Total and differential settlements will be negligible.

7.1 Micro-Piles

The use of proprietary foundation systems can be considered, generically described as “micropiles”, such as helical piers, etc. These micropiles/helical piers will be installed within a lined hole, likely installed by a percussion drill, such as a water well rig. The actual foundation system capacity depends on the specific installation method, size, and spacing, and should be specified by the specialty supplier and proven by field tests. Consideration should be given for compressive, uplift and lateral testing.

These type of piles should be grouted into place and attached to the modified foundation. Also, and if necessary, the building can be lifted back to its original location. Windows and doors would likely have to be removed during this operation and the openings reinforced.

We will be happy to assist with further details once the foundation system is finalized. However, the final design should be based on the confirmation of the system's capacity, on the basis of field load tests.

7.2 Drilled Piles

Drilled piles, which include either having a drill shoe on the end of the pile or utilizing a collapsible bit that is passed through the pile, may be considered. These piles will be socketed into the bedrock, tapped into place and grouted. The required sockets should be at least 1 m in depth.

The most suitable pile type will probably consist of heavy walled, high stress steel piles. In principle, the geotechnical capacity of such piles should be close to their allowable structural capacity. As an example, pipe pile with an outside diameter (OD) of 240 mm O.D. x 19 mm wall thickness, with a yield strength of 350 MPa will give a factored ultimate geotechnical resistance of 1850 kN. The actual mobilised pile capacity should be demonstrated by adequate field testing such as pile dynamic analysis (PDA) testing or static load testing. The anticipated allowable geotechnical capacity of a pile driven into a socket in the rock, without structural damage, should be in the order of 0.3F_y times the steel area. The settlement of the pile will be generally negligible and limited to the elastic shortening of the pile.

It may be preferable to only state the required pile capacity in the construction tender to potentially take advantage of readily available, lower priced piles.

The piles should be designed with increased tolerances for deviations from plumb and location, as piles may deviate due to obstructions in the overburden. As such, normally accepted tolerances in the piling industry of 2% out of plumbness and 75 mm out of location should be increased to larger tolerances.

Once the pile type is chosen and the hammer type/energy are known, a preliminary pile 'set criteria' should be selected for achieving the required capacity, when tapping the pile into the bedrock socket. The preliminary 'set criteria' should be reviewed by this office and should be confirmed in the field by load testing or the use of a PDA during pile driving. An independent full-time piling inspector must confirm the 'set criteria' on each pile. Pile driving should preferably follow O.P.S.S.903 guidelines, particularly during final 'seating' procedures.

Consideration should be given to conducting PDA testing early on the program to confirm design pile capacities. For past projects, PDA testing was conducted initially and during the project, which has allowed for a reduction in the applied factor of safety due to the comfort level of the civil and geotechnical consultant.

8.0 CLOSURE

The Limitations of Report, as presented in Appendix E, forms an integral part of this report.

Given the unique nature of the project and complexity of the causes for the structural distress, the subsurface information and geotechnical recommendations provided in this report may not be sufficient to optimize the remedial solution for the building rehabilitation. It should be noted that our previous report suggested settlement monitoring, to determine if the building continues to move, which has not been completed. This recommendation is not so critical at this point, considering the preferred remedial option is to install piles, which should stop any further movements.

The recommendations included in this report, although site specific, have a general nature. Once the intended design details and construction methods are available, we recommend a geotechnical consultant be retained to review this information to ensure conformance with the assumptions and limitations considered. This is particularly important when it comes to the review of the preferred remedial option, etc.

We trust that the information presented in this report is complete within our terms of reference. If you have any questions, please do not hesitate to contact our office.

Respectfully submitted,

AMEC Environment & Infrastructure
A Division of AMEC Americas Limited

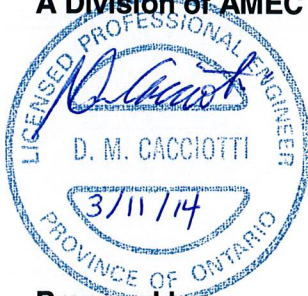

Prepared by:
Dan Cacciotti, P.Eng.
Project Engineer

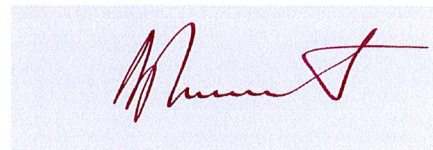

Reviewed by:
Dan Dimitriu, PhD, P.Eng.
Associate Geotechnical Engineer

9.0 REFERENCES

Cooper, H.H. and C.E. Jacob, 1946. A generalized graphical method for evaluating formation constants and summarizing well field history, Am. Geophys. Union Trans., vol. 27, pp. 526-534.

Duffield, G.M., 2007. *AQTESOLV for Windows Version 4.5 User's Guide*, HydroSOLVE, Inc., Reston, VA.

Theis, C.V., 1935. The relation between the lowering of the piezometric surface and the rate and duration of discharge of a well using groundwater storage, Am. Geophys. Union Trans., vol. 16, pp. 519-524.

EXPLANATION OF BOREHOLE LOG

This form describes some of the information provided on the borehole logs, which is based primarily on examination of the recovered samples, and the results of the field and laboratory tests. Additional description of the soil/rock encountered is given in the accompanying geotechnical report.

GENERAL INFORMATION

Project details, borehole number, location coordinates and type of drilling equipment used are given at the top of the borehole log.

SOIL LITHOLOGY

Elevation and Depth

This column gives the elevation and depth of inferred geologic layers. The elevation is referred to the datum shown in the Description column.

Lithology Plot

This column presents a graphic depiction of the soil and rock stratigraphy encountered within the borehole.

Description

This column gives a description of the soil strata, based on visual and tactile examination of the samples augmented with field and laboratory test results. Each stratum is described according to the *Modified Unified Soil Classification System*.

The compactness condition of cohesionless soils (SPT) and the consistency of cohesive soils (undrained shear strength) are defined as follows (*Ref. Canadian Foundation Engineering Manual*):

Compactness of	
Cohesionless Soils	SPT N-Value
Very loose	0 to 4
Loose	4 to 10
Compact	10 to 30
Dense	30 to 50
Very Dense	> 50

Consistency of Cohesive Soils	Undrained Shear Strength	
	kPa	psf
Very soft	0 to 12	0 to 250
Soft	12 to 25	250 to 500
Firm	25 to 50	500 to 1000
Stiff	50 to 100	1000 to 2000
Very stiff	100 to 200	2000 to 4000
Hard	Over 200	Over 4000

Soil Sampling

Sample types are abbreviated as follows:

SS	Split Spoon	TW	Thin Wall Open (Pushed)	RC	Rock Core	GS	Grab Sample
AS	Auger Sample	TP	Thin Wall Piston (Pushed)	WS	Washed Sample	AR	Air Return Sample

Additional information provided in this section includes sample numbering, sample recovery and numerical testing results.

Field and Laboratory Testing

Results of field testing (e.g., SPT, pocket penetrometer, and vane testing) and laboratory testing (e.g., natural moisture content, and limits) executed on the recovered samples are plotted in this section.

Instrumentation Installation

Instrumentation installations (monitoring wells, piezometers, inclinometers, etc.) are plotted in this section. Water levels, if measured during fieldwork, are also plotted. These water levels may or may not be representative of the static groundwater level depending on the nature of soil stratum where the piezometer tips are located, the time elapsed from installation to reading and other applicable factors.

Comments

This column is used to describe non-standard situations or notes of interest.

MODIFIED * UNIFIED CLASSIFICATION SYSTEM FOR SOILS
 *The soil of each stratum is described using the Unified Soil Classification System (Technical Memorandum 36-357 prepared by Waterways Experiment Station, Vicksburg, Mississippi, Corps of Engineers, U.S Army, Vol. 1 March 1953.) modified slightly so that an inorganic clay of "medium plasticity" is recognized.

MAJOR DIVISION		GROUP SYMBOL	TYPICAL DESCRIPTION	LABORATORY CLASSIFICATION CRITERIA	
COARSE GRAINED SOILS (MORE THAN HALF BY WEIGHT LARGER THAN 75µm)	GRAVELS MORE THAN HALF THE COARSE FRACTION LARGER THAN 4.75mm	CLEAN GRAVELS (TRACE OR NO FINES)	GW	WELL GRADED GRAVELS, GRAVEL-SAND MIXTURES, LITTLE OR NO FINES	$C_u = \frac{D_{60}}{D_{10}} > 4; C_c = \frac{(D_{30})^2}{D_{10} \times D_{60}} = 1 \text{ to } 3$
		DIRTY GRAVELS (WITH SOME OR MORE FINES)	GP	POORLY GRADED GRAVELS, GRAVEL-SAND MIXTURES, LITTLE OR NO FINES	NOT MEETING ABOVE REQUIREMENTS
		DIRTY GRAVELS (WITH SOME OR MORE FINES)	GM	SILTY GRAVELS, GRAVEL-SAND- SILT MIXTURES	ATTERBERG LIMITS BELOW "A" LINE OR P.I MORE THAN 4
			GC	CLAYEY GRAVELS, GRAVEL-SAND-CLAY MIXTURES	ATTERBERG LIMITS BELOW "A" LINE OR P.I MORE THAN 7
	SANDS MORE THAN HALF THE COARSE FRACTION SMALLER THAN 4.75mm	CLEAN SANDS (TRACE OR NO FINES)	SW	WELL GRADED SANDS, GRAVELLY SANDS, LITTLE OR NO FINES	$C_u = \frac{D_{60}}{D_{10}} > 6; C_c = \frac{(D_{30})^2}{D_{10} \times D_{60}} = 1 \text{ to } 3$
		DIRTY SANDS (WITH SOME OR MORE FINES)	SP	POORLY GRADED SANDS, GRAVEL- SAND MIXTURES, LITTLE OR NO FINES	NOT MEETING ABOVE REQUIREMENTS
		DIRTY SANDS (WITH SOME OR MORE FINES)	SM	SILTY SANDS, SAND-SILT MIXTURES	ATTERBERG LIMITS BELOW "A" LINE OR P.I MORE THAN 4
			SC	CLAYEY SANDS, SAND-CLAY MIXTURES	ATTERBERG LIMITS BELOW "A" LINE OR P.I MORE THAN 7
FINE-GRAINED SOILS (MORE THAN HALF BY WEIGHT SMALLER THAN 75µm)	SILTS BELOW "A" LINE NEGLIGIBLE ORGANIC CONTENT	$W_L < 50\%$	ML	INORGANIC SILTS AND VERY FINE SANDS, ROCK FLOUR, SILTY SANDS OF SLIGHT PLASTICITY	CLASSIFICATION IS BASED UPON PLASTICITY CHART (SEE BELOW)
		$W_L < 50\%$	MH	INORGANIC SILTS, MICACEOUS OR DIATOMACEOUS, FINE SANDY OR SILTY SOILS	
	CLAYS ABOVE "A" LINE NEGLIGIBLE ORGANIC CONTENT	$W_L < 30\%$	CL	INORGANIC CLAYS OF LOW PLASTICITY, GRAVELLY, SANDY OR SILTY CLAYS, LEAN CLAYS	
		$30\% < W_L < 50\%$	CI	INORGANIC CLAYS OF MEDIUM PLASTICITY, SILTY CLAYS	
		$W_L < 50\%$	CH	INORGANIC CLAYS OF HIGH PLASTICITY, FAT CLAYS	
	ORGANIC SILTS & CLAYS BELOW "A" LINE	$W_L < 50\%$	OL	ORGANIC SILTS AND ORGANIC SILTY CLAYS OF LOW PLASTICITY	WHENEVER THE NATURE OF THE FINES CONTENT HAS NOT BEEN DETERMINED, IT IS DESIGNATED BY THE LETTER "F", E.G SF IS A MIXTURE OF SAND WITH SILT OR CLAY
		$W_L < 50\%$	OH	ORGANIC CLAYS OF HIGH PLASTICITY	
	HIGH ORGANIC SOILS		Pt	PEAT AND OTHER HIGHLY ORGANIC SOILS	STRONG COLOUR OR ODOUR, AND OFTEN FIBROUS TEXTURE

SOIL COMPONENTS					
FRACTION	U.S STANDARD SIEVE SIZE	DEFINING RANGES OF PERCENTAGE BY WEIGHT OF MINOR COMPONENTS			
		PASSING	RETAINED	PERCENT	DESCRIPTOR
GRAVEL	COARSE	75 mm	19 mm	35-50	AND
				20-35	Y/EY
	FINE	19 mm	4.75 mm	10-20	SOME
SAND	COARSE	4.75 mm	2.00 mm	1-10	TRACE
	MEDIUM	2.00 mm	425 µm		
	FINE	425 µm	75 µm		
FINES (SILT OR CLAY BASED ON PLASTICITY)		75 µm			
OVERSIZED MATERIAL					
ROUNDED OR SUBROUNDED: COBBLES 75 mm to 300 mm BOULDERS > 300 mm				NOT ROUNDED: ROCK FRAGMENTS > 76 mm ROCKS > 0.76 CUBIC METRE IN VOLUME	

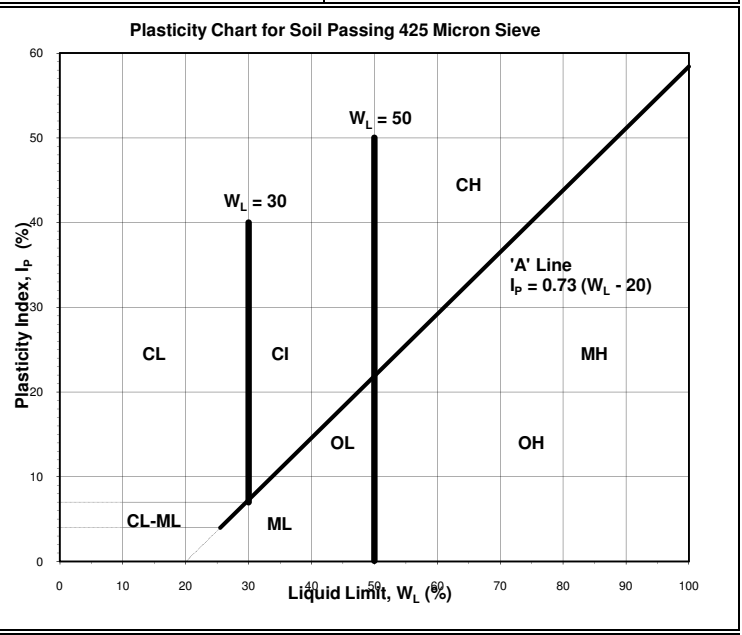

AMEC Environment & Infrastructure
 131 Fielding Rd.
 Lively, ON P3Y 1L7
 Ph: (705) 682-2632
 Fax: (705) 682-2260
 www.amec.com

Note 1: Soils are classified and described according to their engineering properties and behaviour.
 Note 2: The modifying adjectives used to define the actual or estimated percentage range by weight of minor components are consistent with the Canadian Foundation Engineering Manual (3rd Edition, Canadian Geotechnical Society, 1992.)
 Rev. March 2012

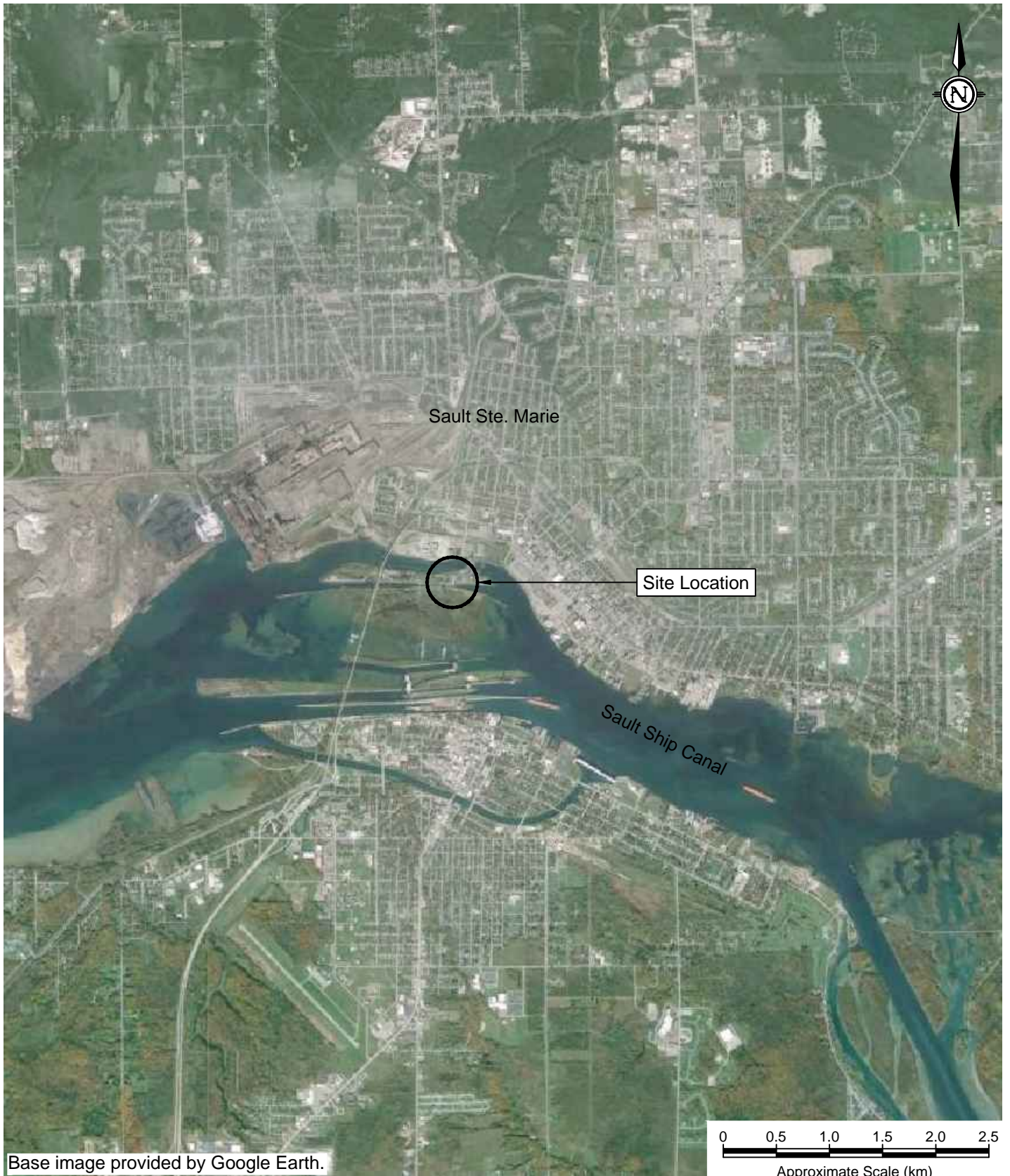

Base image provided by Google Earth.

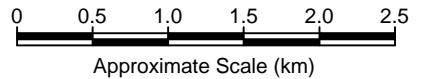

AMEC Environment & Infrastructure

131 Fielding Road
Lively, Ontario
P3Y 1L7
705-682-2632



Rowswell & Associates, Engineers Inc.

PROJECT	Additional Geotechnical Test Hole Investigation Proposed Structural Stabilization of Stores Building Sault Ste. Marie, Ontario	DWN BY:	CHK'D BY:	DATE:
		MAT	DMC	February 2014
TITLE	Site Location Map	REV. NO.:	SCALE:	PROJECT NO:
		1	as shown	TY1230281
				FIGURE NO:
				1

Legend:

- ◆ Borehole (2013 AMEC)
- ⊕ Borehole (1984 Geocon)
- ⊞ Test Pit (2013 AMEC)
- ⊞ Test Pit (2013 Rowswell)
- Test Pit (1984 Geocon)

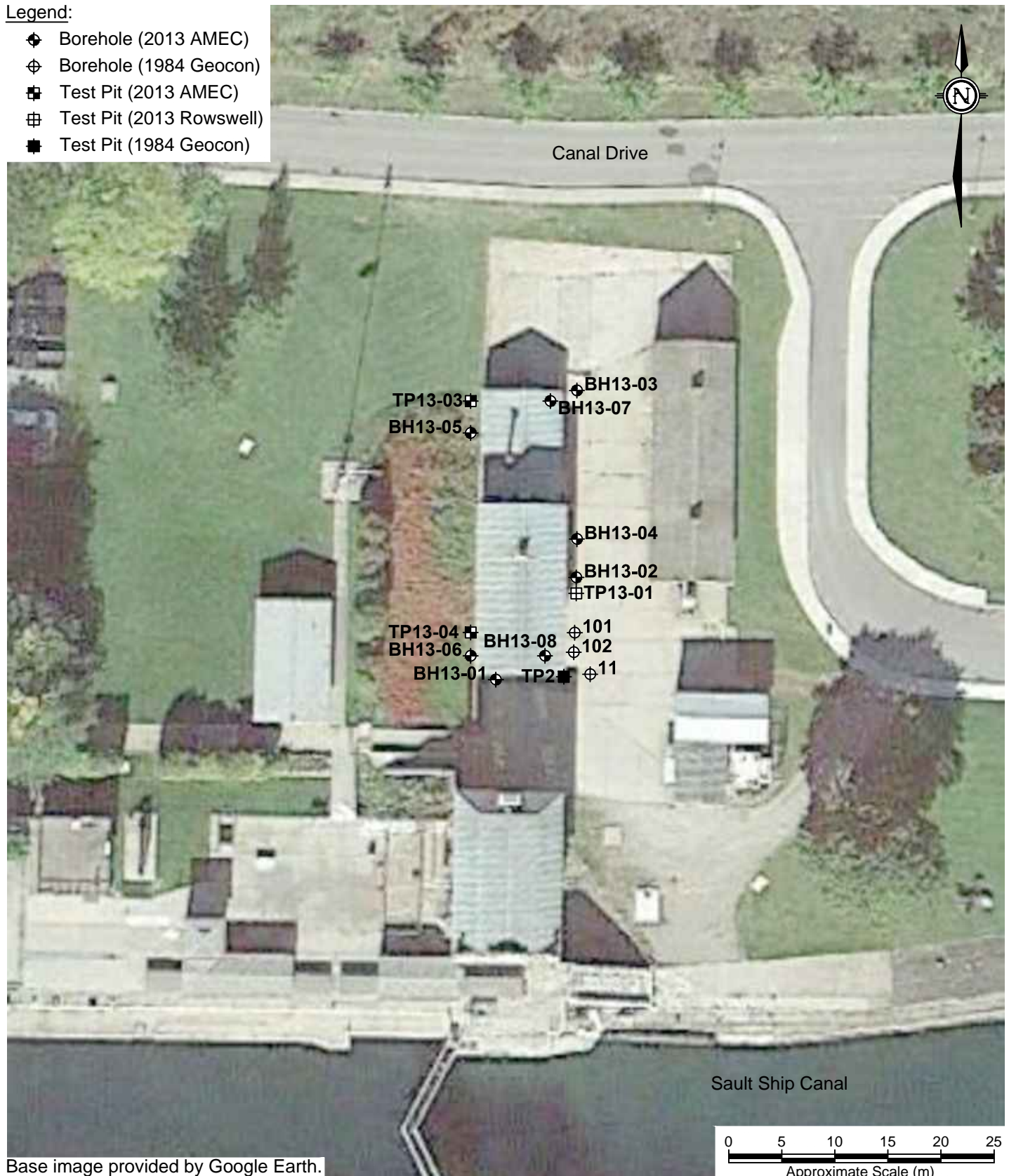

AMEC Environment & Infrastructure

131 Fielding Road
Lively, Ontario
P3Y 1L7
705-682-2632



Rowswell & Associates, Engineers Inc.

PROJECT Additional Geotechnical Test Hole Investigation Proposed Structural Stabilization of Stores Building Sault Ste. Marie, Ontario	DWN BY: MAT	CHKD BY: DMC	DATE: February 2014
	REV. NO.: 1	SCALE: as shown	PROJECT NO: TY1230281
TITLE Borehole and Test Hole Location Plan			FIGURE NO: 2

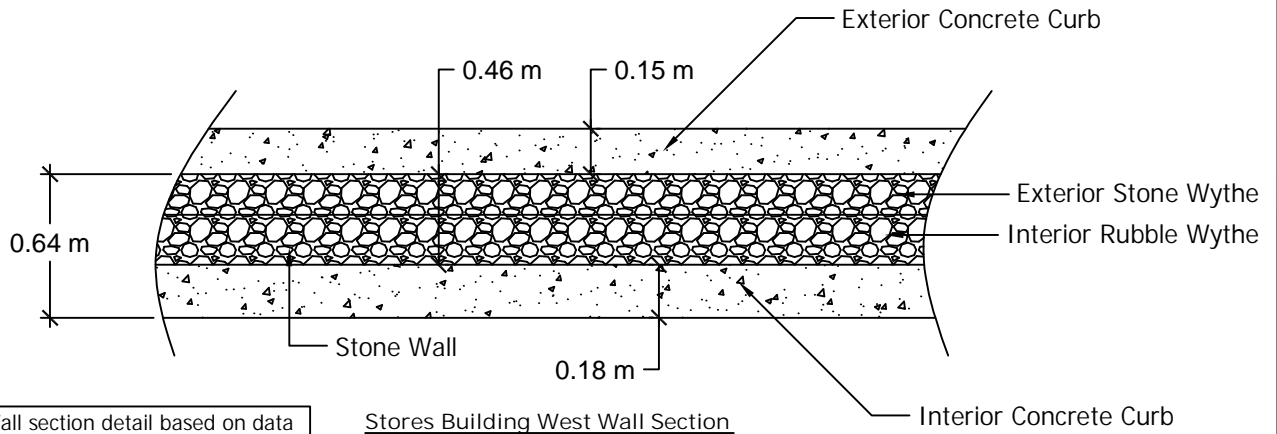

Note: Wall section detail based on data from coreholes CH13-01 & CH13-02.

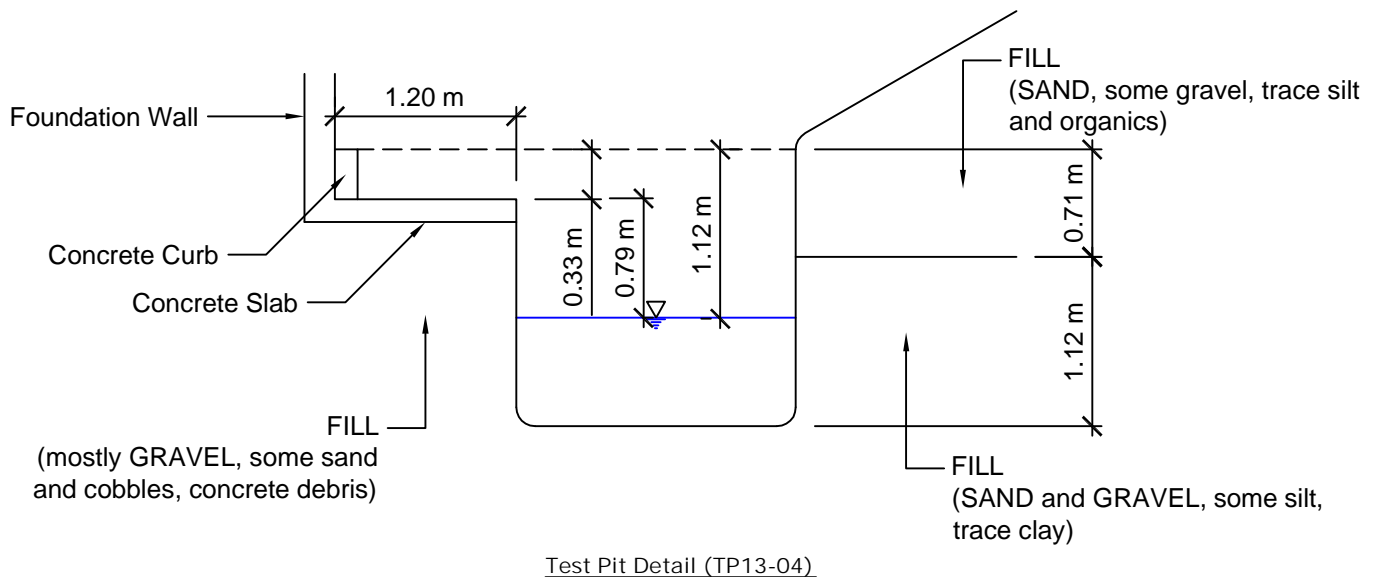
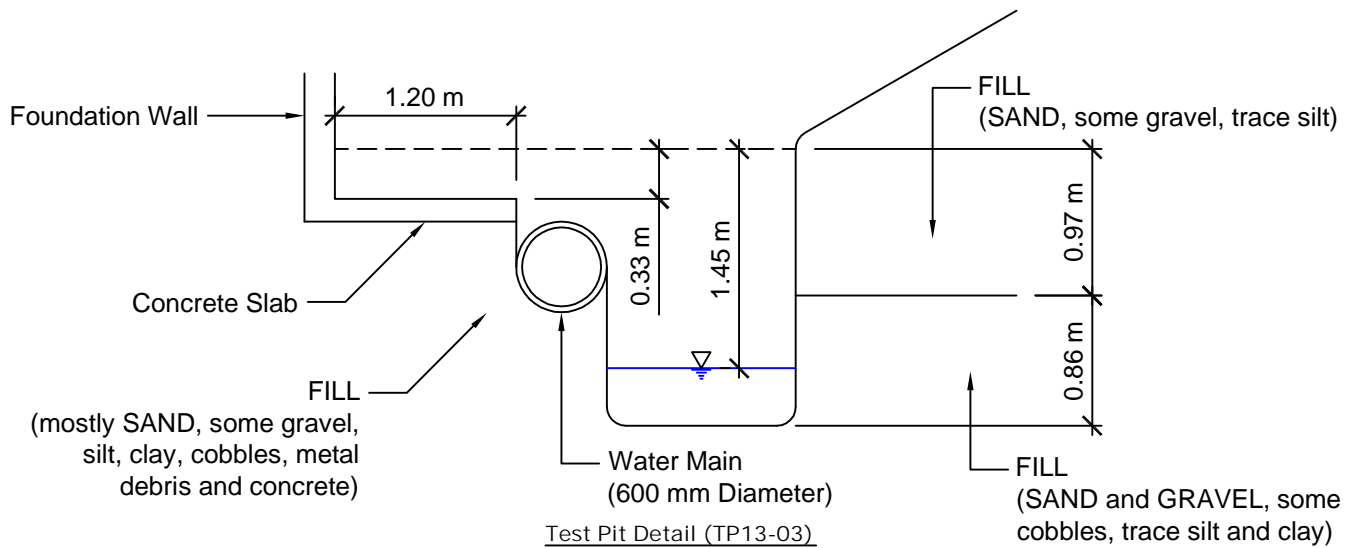

AMEC Environment & Infrastructure

131 Fielding Road
Lively, Ontario
P3Y 1L7
705-682-2632



Rowswell & Associates, Engineers Inc.

PROJECT Additional Geotechnical Test Hole Investigation
Proposed Structural Stabilization of Stores Building
Sault Ste. Marie, Ontario

DWN BY:

CHK'D BY:

DATE: February 2014

MAT

DMC

PROJECT NO: TY1230281

TITLE

Foundation and Test Pit Details

REV. NO.:

SCALE:

FIGURE NO:

1

as shown

3

**GRAIN SIZE DISTRIBUTION ANALYSIS (ASTM D 422)
OPSS 1010-3, Table 2, April 2004 - Granular B, Type I**

GRAVEL		SAND					FINES	
Coarse	Fine	Coarse	Medium	Fine		Silt and Clay		

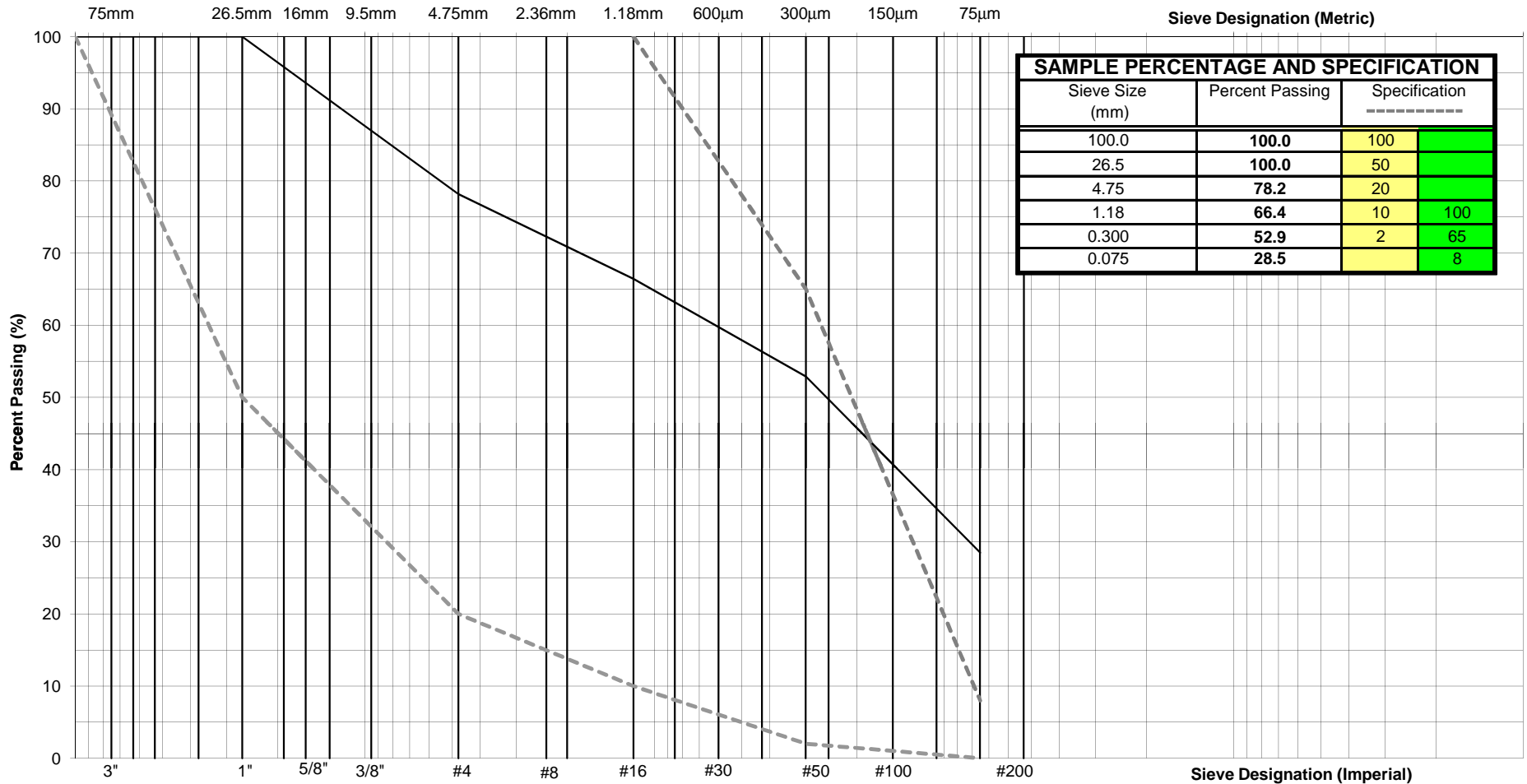

CLIENT LOGO:

CLIENT NAME:
**Rowswell & Associates,
Engineers Inc.**

SAMPLED BY:
AR Martel, AMEC
RECEIVED BY:
MM Dupont, AMEC
TESTED BY:
MM Dupont, AMEC
DATE:
06-Jan-14

PROJECT:
**Additional Geotechnical Test Hole Investigation
Proposed Structural Stabilization of Stores Building
Sault Ste. Marie, Ontario**
SAMPLE LOCATION:
TP13-04 GS02 0.6 to 1.2 m
SAMPLE IDENTIFICATION:
GRAVELLY, SILTY / CLAYEY SAND

REV. No.:
LAB No.:
SB14009
PROJECT No.:
TY1230281
FIGURE No.:
4

**GRAIN SIZE DISTRIBUTION ANALYSIS (ASTM D 422)
OPSS 1010-3, Table 2, April 2004 - Granular B, Type I**

GRAVEL		SAND					FINES
Coarse	Fine	Coarse	Medium	Fine		<i>Silt and Clay</i>	

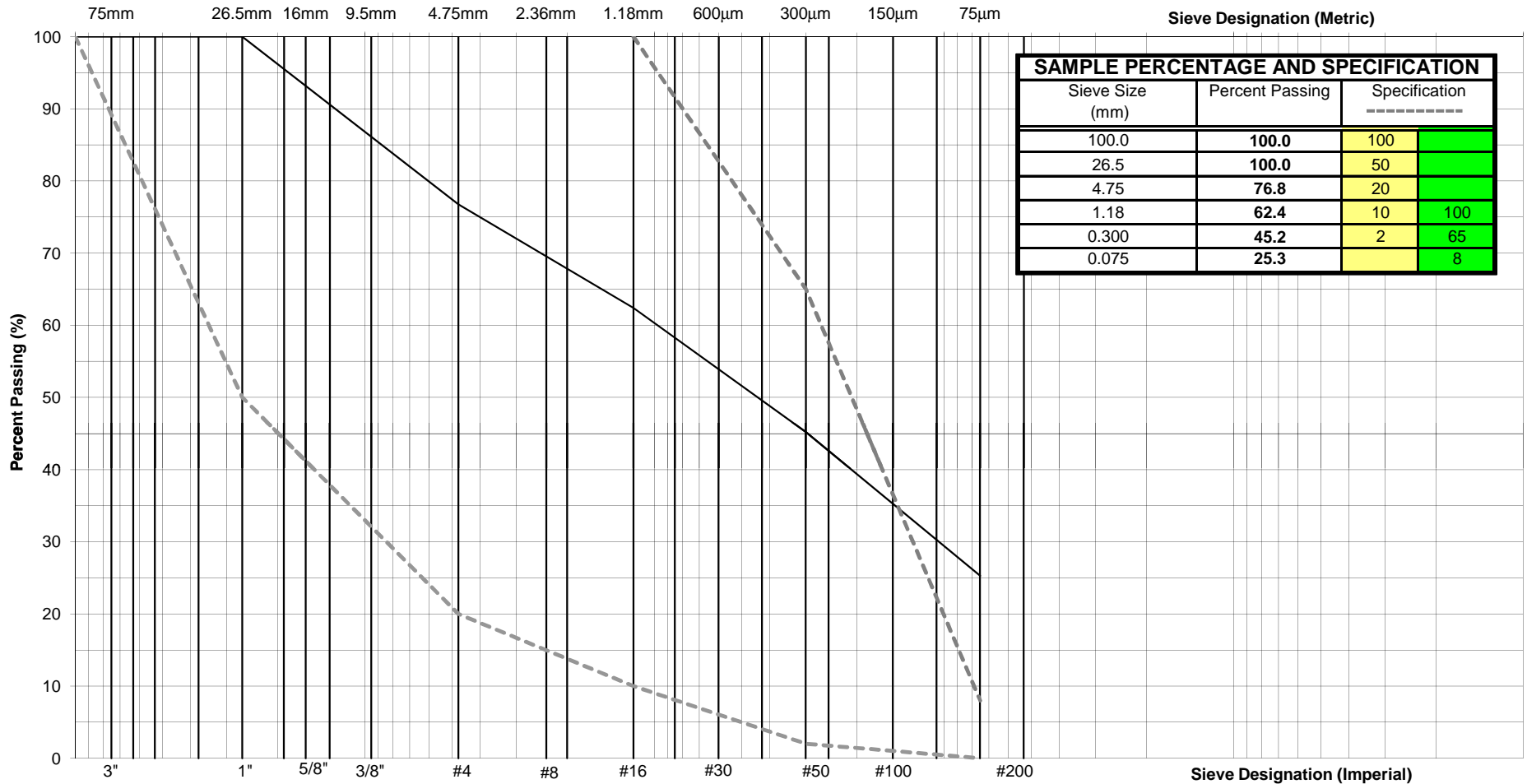

CLIENT LOGO:

CLIENT NAME:
**Rowswell & Associates,
Engineers Inc.**

SAMPLED BY:
AR Martel, AMEC
RECEIVED BY:
MM Dupont, AMEC
TESTED BY:
MM Dupont, AMEC
DATE:
06-Jan-14

PROJECT:
**Additional Geotechnical Test Hole Investigation
Proposed Structural Stabilization of Stores Building
Sault Ste. Marie, Ontario**
SAMPLE LOCATION:
TP13-03 GS02 0.8 to 1.0 m
SAMPLE IDENTIFICATION:
GRAVELLY, SILTY / CLAYEY SAND

REV. No.:
LAB No.:
SB14010
PROJECT No.:
TY1230281
FIGURE No.:
5

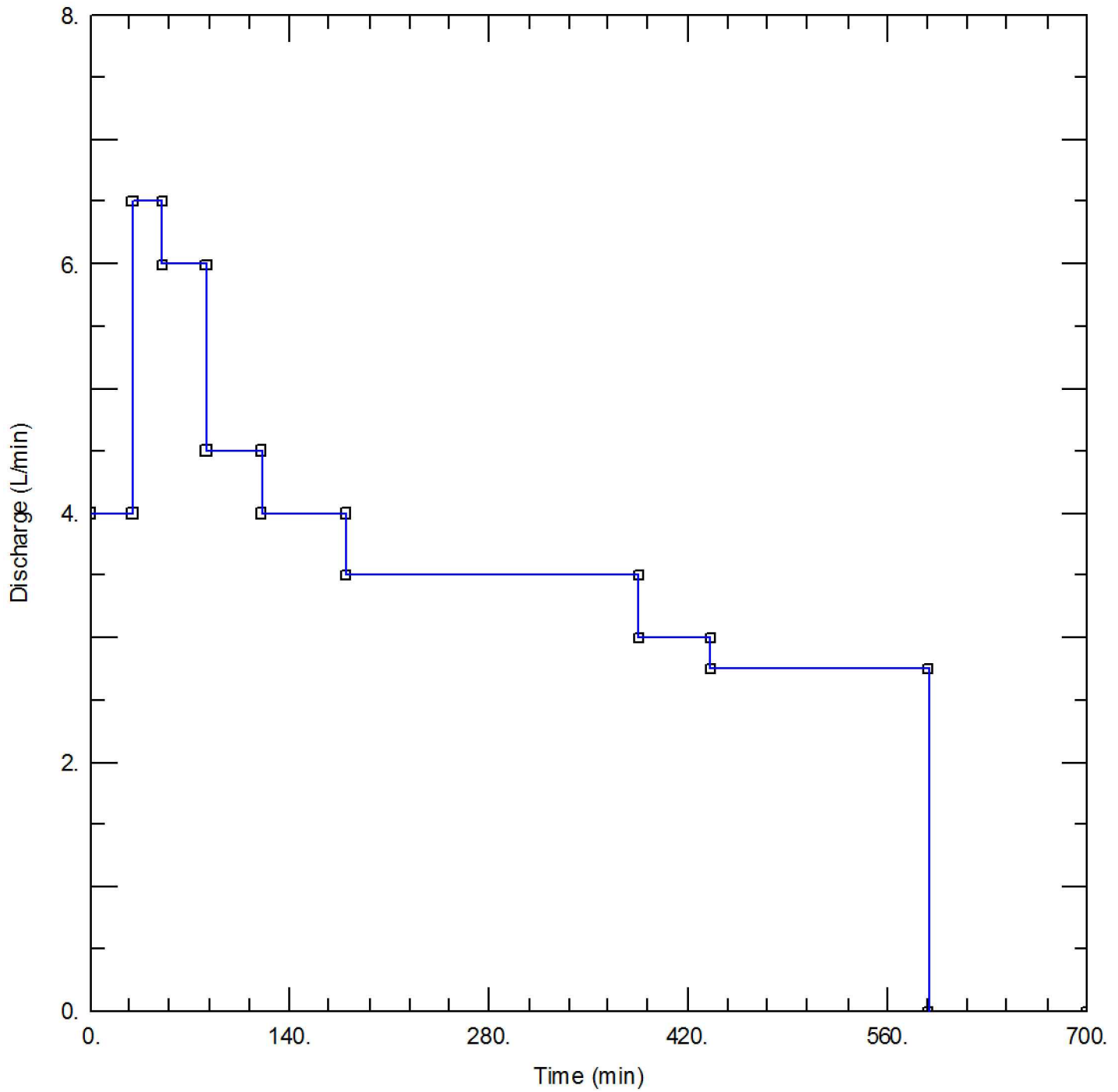

AMEC Environment & Infrastructure

131 Fielding Road
Lively, Ontario
P3Y 1L7
705-682-2632



Rowswell & Associates, Engineers Inc.

PROJECT Additional Geotechnical Test Hole Investigation
Proposed Structural Stabilization of Stores Building
Sault Ste. Marie, Ontario

DWN BY:

MAT

CHKD BY:

DMC

DATE: January 2014

PROJECT NO: TY1230281

TITLE 8 Hour Pumping Test at BH13-04 (Discharge vs. Time)

REV. NO.:

1

SCALE:

as shown

FIGURE NO: 6

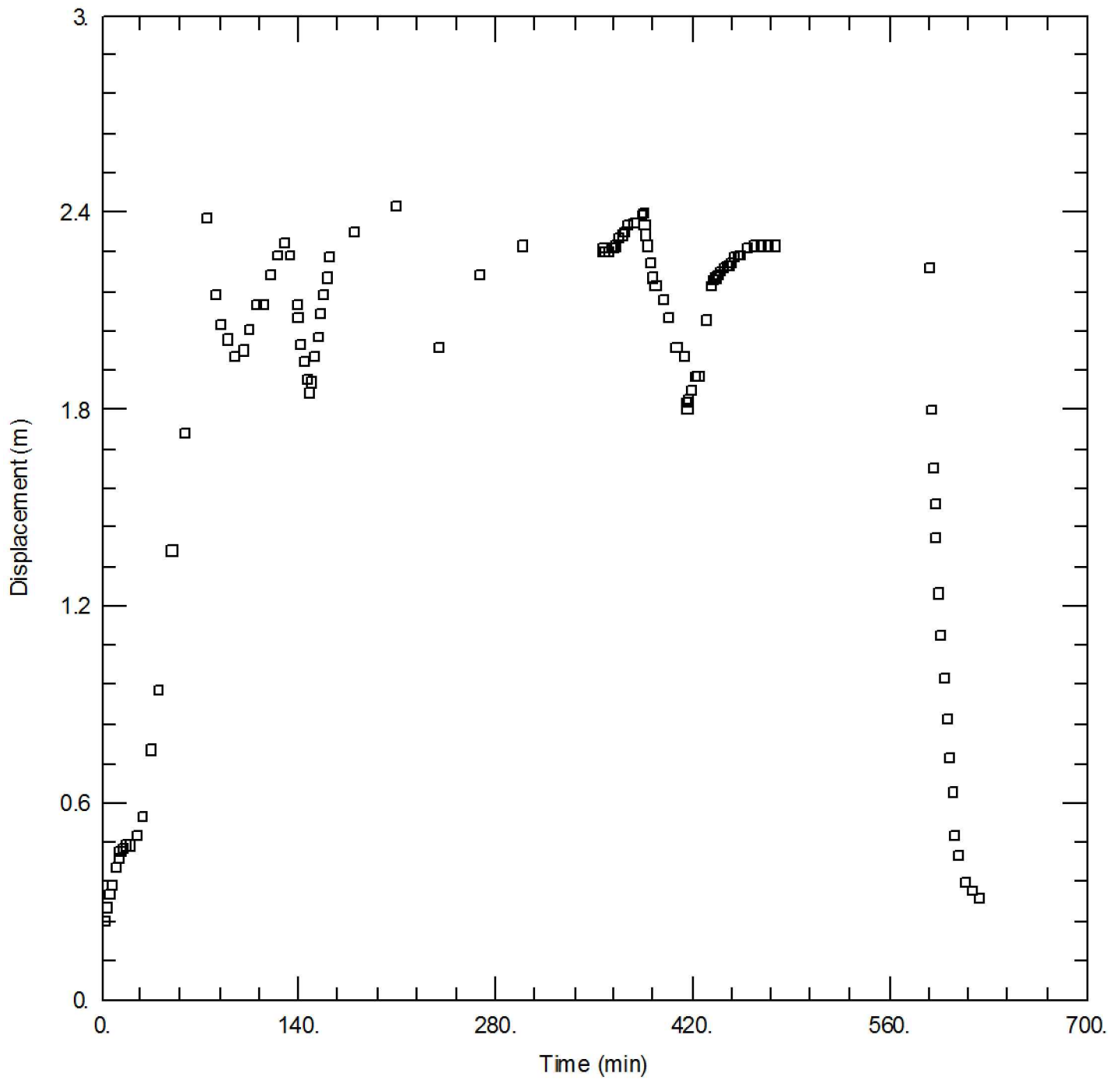

AMEC Environment & Infrastructure

131 Fielding Road
Lively, Ontario
P3Y 1L7
705-682-2632



Rowswell & Associates, Engineers Inc.

PROJECT Additional Geotechnical Test Hole Investigation
Proposed Structural Stabilization of Stores Building
Sault Ste. Marie, Ontario

DWN BY:

MAT

CHKD BY:

DMC

DATE: January 2014

PROJECT NO: TY1230281

TITLE 8 Hour Pumping Test at BH13-04 (Displacement vs. Time)

REV. NO.:

1

SCALE:

as shown

FIGURE NO: 7

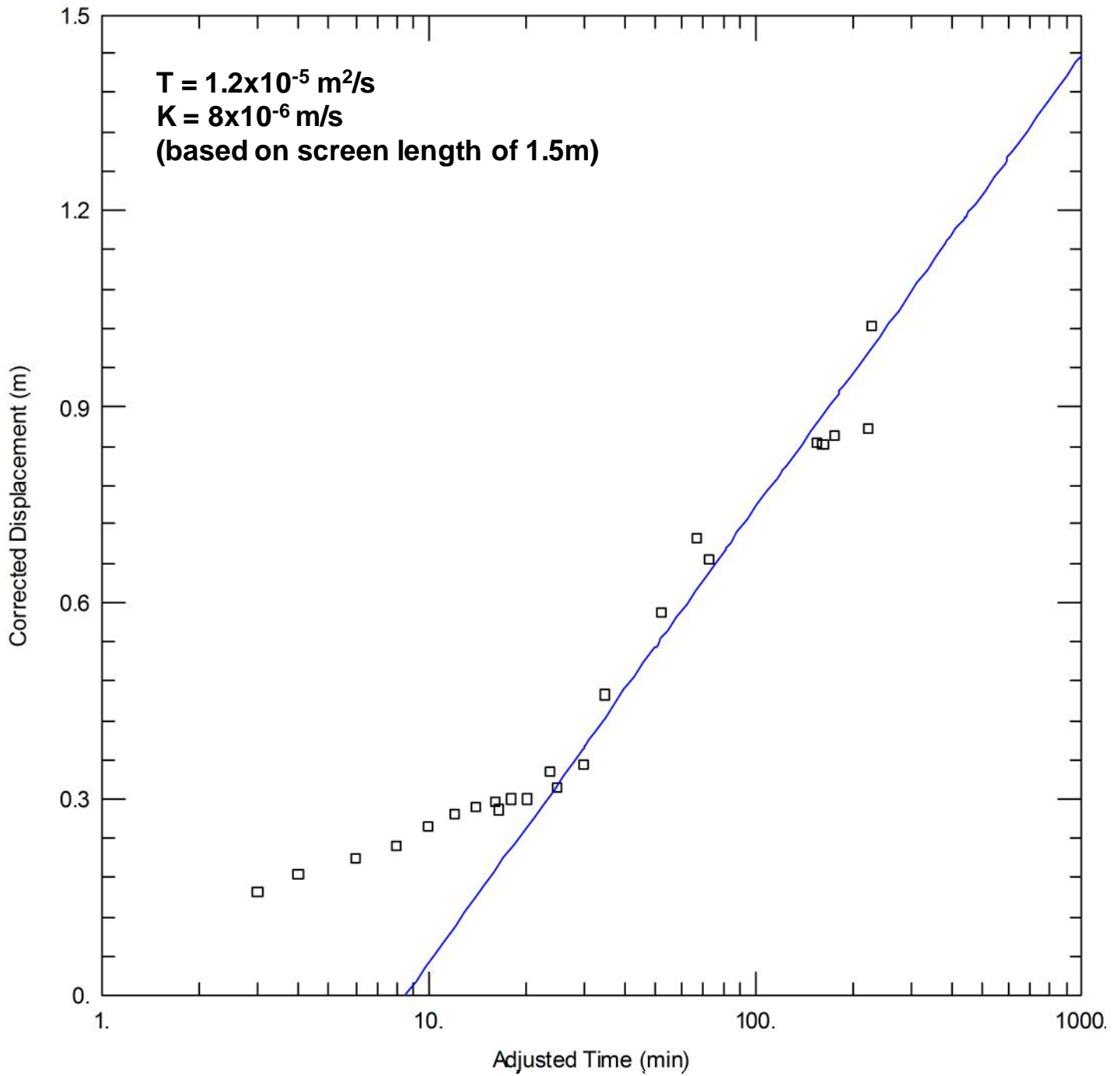

AMEC Environment & Infrastructure 131 Fielding Road Lively, Ontario P3Y 1L7 705-682-2632				Rowswell & Associates, Engineers Inc.	
PROJECT Additional Geotechnical Test Hole Investigation Proposed Structural Stabilization of Stores Building Sault Ste. Marie, Ontario		DWN BY: MAT	CHK'D BY: DMC	DATE: February 2014 PROJECT NO: TY1230281	
TITLE Cooper-Jacob Analysis of Observed Drawdown Data		REV. NO.: 1	SCALE: as shown	FIGURE NO: 8	

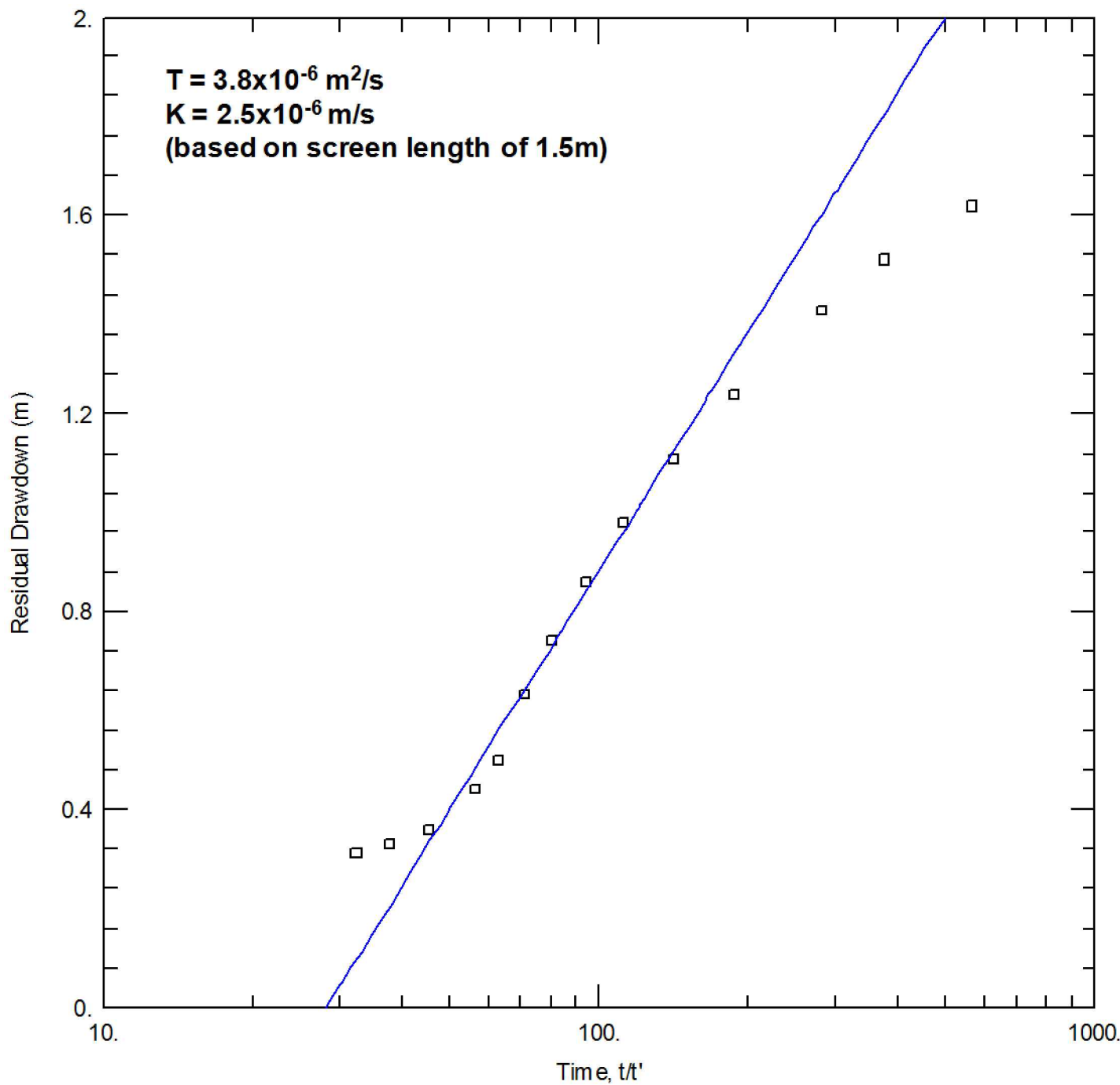

AMEC Environment & Infrastructure

131 Fielding Road
Lively, Ontario
P3Y 1L7
705-682-2632



Rowswell & Associates, Engineers Inc.

PROJECT Additional Geotechnical Test Hole Investigation
Proposed Structural Stabilization of Stores Building
Sault Ste. Marie, Ontario

DWN BY:

MAT

CHKD BY:

DMC

DATE: January 2014

PROJECT NO: TY1230281

TITLE This Analysis of Observed Recovery Data

REV. NO.:

1

SCALE:

as shown

FIGURE NO:

9

Rowswell and Associates Engineers Inc.
Additional Geotechnical Test Hole Investigation
Proposed Structural Stabilization of Stores Building
Sault Ste. Marie, Ontario
March 2014



APPENDIX A
PREVIOUS AMEC REPORT



**GEOTECHNICAL TEST HOLE INVESTIGATION
PROPOSED STRUCTURAL STABILIZATION OF STORES BUILDING
SAULT STE MARIE, ONTARIO**



Submitted to:

Rowswell and Associates Engineers Inc.
100 Bruce Street
Sault Ste. Marie, ON
P6A 2X5

Submitted by:

**AMEC Environment & Infrastructure,
A Division of AMEC Americas Limited**
131 Fielding Road
Lively, Ontario
P3Y 1L7
(705) 682-2632



27 February 2013

AMEC Project No.: TY123028

TABLE OF CONTENTS

Section	Page
1.0 INTRODUCTION	1
1.1 Background	1
2.0 GEOLOGICAL SETTING	2
3.0 INVESTIGATION PROGRAM	2
4.0 SOIL CONDITIONS	4
4.1 Surficial Layer	4
4.2 Sand and Gravel	4
4.3 Bedrock	4
4.4 Groundwater	4
5.0 GEOTECHNICAL CONCERNS	5
5.1 Foundation Walls	5
5.2 Founding Conditions and Supporting Soils	5
5.3 Foundation Backfill Material	6
5.4 Groundwater Effects	6
6.0 RECOMMENDATIONS	6
6.1 Grouting	6
6.2 Underpinning	7
6.3 Foundations to Bedrock	7
6.3.1 Micro-Piles	8
6.3.2 Drilled Piles	8
6.4 Frost Protection	9
6.5 Earthquake Considerations	9
6.6 Excavations	9
6.7 Reuse of Excavated Soil	10
6.8 Lateral Earth Pressures	10
6.9 Subdrainage	11
7.0 CLOSURE	11

Explanation of Borehole Log

Modified Unified Classification System for Soils

LIST OF FIGURES

- Figure 1 Site Location Map
- Figure 2 Test Hole Location Plan
- Figure 3 Existing Foundation Details
- Figure 4 Grain Size Distribution Analysis – BH13-01 Split Spoon Sample 5
- Figure 5 Grain Size Distribution Analysis –BH13-03 Split Spoon Sample 2

LIST OF APPENDICES

- Appendix A Previous Geotechnical Reports
- Appendix B Borehole Logs
- Appendix C Limitations of Report

1.0 INTRODUCTION

AMEC Environment & Infrastructure, a division of AMEC Americas Limited (AMEC), has been retained by Rowswell and Associates Engineers Inc. (Rowswell) to complete a Geotechnical Test Hole Investigation for the Parks Canada Agency's (PCA) Request for Proposal 10120583 (RFP), dated 19 September 2012, regarding the structural stabilization of Stores Building in Sault Ste. Marie, Ontario (see Figure 1).

The purpose of this geotechnical investigation was to determine the subsurface conditions and relevant soil properties at a number of test locations in order to augment the subsurface information and develop recommendations for the geotechnical aspects of the proposed repair design.

The anticipated construction conditions are also discussed, but only to the extent that they may influence design decisions. The feasible construction methods, however, express our opinion and are not intended to direct contractors in how to carry out construction. Contractors should also be aware that the data and their interpretation presented in this report may not be sufficient to assess all factors that may have an affect upon construction.

We assume that the work will be carried out in accordance with good engineering practises and all applicable standards and regulations. Environmental considerations were not part of the scope of work for this geotechnical investigation.

There should be an ongoing liaison with AMEC during both the design and construction phases of the project to ensure that the recommendations in this report have been interpreted and implemented correctly. Also, if any further clarification and/or elaboration are needed concerning the geotechnical aspects of this project, AMEC should be contacted immediately.

1.1 Background

Through a review of background information included within the RFP package, AMEC understands that the existing Stores building foundation, built circa 1896, is continuing to undergo duress contributing to the ongoing deterioration of the structure. Previous investigation reports by Geocon Inc. (Geocon), dated September 1984 and November 1985 (included in Appendix A), have suggested that one possible source for the ongoing settlement issue may be related to the flow of water through the existing blast rock fill washing fine soil particles from below the footings.

A Stores building condition assessment (BCA), commissioned by Public Works and Government Services Canada, was issued in December 2010 and indicated the condition of the foundation exposed in a test pit at the south east corner of the building was in very poor condition. A further detailed description of the findings in the test pit, including comments and assessment based on a comprehensive evaluation of the main interacting building components (structure, materials, envelope, site features, etc.) of the entire building condition is provided in the quoted report.

The report went on to suggest that additional geotechnical investigation was required in order to:

1. Confirm the soil / bedrock conditions below the entire building;
2. Monitor foundation movements to determine whether the suspected movement is ongoing;
3. Investigate the source and extent of the groundwater flow;
4. Investigate and confirm the as build condition of the foundation walls; and,
5. Develop feasible options for the stabilization of the foundation.

Based on the Geocon report dated September 1984 (Geocon 1984), in the available background information, the St Mary's Islands was a series of smaller islands joined by infilling gaps with rock blasted from the construction of the locks. It is believed the Stores building was built on fill deposits and has experienced differential movements and cracking of the blocks and mortar. Previous excavations have uncovered voids beneath concrete sidewalks, indicating probable washing away of supporting fill.

Cracking has only been noted in the southern portion of the Stores building, along with differential settlement of the concrete slab adjacent to the Stores building. The adjacent Pumphouse building, thought to be built on bedrock, has not undergone noticeable movements.

During spring thaw, it has also been observed that sink holes form that cause pedestrian hazards. A dye test confirmed a relatively high groundwater flow within the island of 0.05 to 0.1 m/sec.

2.0 GEOLOGICAL SETTING

The primary, surficial geology of the area is glaciolacustrine deposits consisting of either silt and clay, minor sand, basin and quiet water deposits or glaciolacustrine deposits of sand, gravelly sand and gravel, near shore and beach deposits.

The bedrock geology on St. Mary's Island is comprised of Proterozoic-aged Jacobsville Group and Oronto Group sandstone, shale, and conglomerate rocks of the Southern and Superior Provinces.

3.0 INVESTIGATION PROGRAM

The initial fieldwork for this project was carried out on 9 to 10 January 2013, when three (3) sampled boreholes (BH13-01 to 13-03) were advanced to a maximum depth of 8.7 m depth below ground surface. All borehole locations are shown on the Test Hole Location Plan (see Figure 2). The amount of test locations was limited due to the slope on one side of the building, existing concrete slabs around the building and uncertainties pertaining to the location of buried services.

The boreholes were advanced with a track mounted soils drill rig and the logs are presented in Appendix B. All borehole locations were determined in the field based on a drawing provided by the client.

The sampled boreholes were advanced using hollow stem augers and conventional soil sampling methods. Soil samples were collected at predetermined depth intervals in accordance with Standard Penetration Testing procedures (ASTM D-1586) utilizing a mechanical hammer.

Test results are recorded on the Borehole Logs (Appendix B) as 'N'-values. These values provide an indication of the various soil strata's condition with respect to compactness or consistency. The samples were field logged by an experienced soil technologist, placed in plastic bags and delivered to our office for further examination and testing.

The boreholes were surveyed by our field staff using a temporary benchmark with an assumed elevation of 100 m. Borehole locations were also geo-referenced to UTM co-ordinates using a portable Global Positioning System (GPS). Elevations and GPS co-ordinates on the borehole logs can be found in Appendix B.

As a follow-up to the borehole investigation, a test pit was excavated and supervised by Rowswell. The test pit (TP13-01) was advanced adjacent to BH13-02, with details presented on Figure 3. The surficial concrete slab was cut and removed and the test pit excavated with a small Bobcat machine.



Photo 1: View of TP13-01. Poor quality fill, foundation wall to the right and infiltrating groundwater.

4.0 SOIL CONDITIONS

A summary of the subsurface conditions encountered in the boreholes and test pit are presented below.

4.1 Surficial Layer

Beneath the surficial concrete slab is a layer of fill comprising sand and gravel mixed with varying clay, silt, cobbles, boulders and organics. Other debris is noticeable in the test pit, such as reinforcing bars, etc. The fill is thought to be as deep as 2 m, based on the borehole sampling. The fill is expected to range in thickness and quality across the site. A grain size distribution of the fill is shown on Figure 5. It is probable that the fill material was taken from construction activities elsewhere on the island.

4.2 Sand and Gravel

Underlying the fill layer is a red to brown, moist to wet, sand and gravel with some silt and trace clay. It is likely this layer represents a glacial till layer that extends to the bedrock surface. A grain size distribution analysis is presented as Figure 4.

4.3 Bedrock

Bedrock was cored in all 3 boreholes. The bedrock is a sandstone and generally increases in quality with depth. Total core recovery (TCR), which is a measurement of how much core was recovered compared to how much was actually cored, ranged from 42 to 100%. Solid core recovery (SCR), which is a measurement of the total length of solid rock core compared to the total length, ranged from 0 to 93%. The Rock Quality Designation (RQD), which is the total length of pieces over 100 mm in length compared to the total length, ranged from 0 to 93%, indicating a very poor to excellent rock quality, but generally poor.

4.4 Groundwater

Groundwater was encountered within the boreholes and recorded to between 0.3 to 0.6 m below existing grades. It is possible these levels are reflective of the bedrock coring process, which uses large amounts of water to cool the drill bit. If this drill water was trapped and/or not permitted to dissipate, it would have given a higher water level. During the test pit excavation, and once a depth of 1 m was reached, groundwater from beneath the building began to fill the excavation. It is probable that groundwater flow paths are forcing water beneath the building, within the foundation walls, but is becoming trapped because of lower permeability fill along the downstream walls. Repairs should consider measures to allow for groundwater to flow freely from beneath the building, such as drainage pipes through the foundation wall, etc.

The long term groundwater level is expected to fluctuate, being lower during extended dry periods and higher during wet periods and directly related to the operation of the locks and the water levels around the island.

5.0 GEOTECHNICAL CONCERNS

Based on the available background information, and previous and current investigations and inspections, several geotechnically related concerns have been identified. They include the following:

1. The actual foundation walls are old and not constructed of the most preferred components.
2. The founding conditions and supporting soils are variable and possibly deleterious in some areas.
3. Foundation backfill material is variable and deleterious in areas.
4. Groundwater is shallow and flows readily through the area, at a relatively high rate.
5. Groundwater levels may fluctuate considerably over the year.
6. The west foundation wall located along the toe of a slope may be subjected to a lateral unbalanced earth pressure.

5.1 Foundation Walls

The foundation walls are constructed of cobble and boulder sized stones which were originally held together with mortar. The quality of the mortar, the effects of freeze-thaw cycles, poor founding conditions, and probable movement of the foundation walls has resulted in a weakened and deteriorated structure.

It is also possible the wall structure is failing or slowly deteriorating, also causing structural deformations.

5.2 Founding Conditions and Supporting Soils

The development of the site, and the backfilling techniques, with varying backfill materials has resulted in variable founding conditions and differing frost susceptibility. Some structures are founded directly on bedrock, or properly compacted blast rock, and have not undergone movements. Other structures have been constructed on poor quality fill and/or poorly placed fill.

Valleys filled with coarse blast rock have provided a preferred groundwater flow path and have subsequently affected the buildings constructed above these paths.

Depending on placement techniques, the blast rock could be susceptible to movement through shifting or consolidating due to vibrations, forces from groundwater flow, etc. Placement of materials beside each other that are not filter compatible could cause finer soil to flow into voids of adjacent, coarser material, and cause movements/settlement.

If foundations were placed on organic soils, these soils maybe undergoing decomposition or consolidation. The decomposition and consolidation would be affected by fluctuations in the groundwater level.

5.3 Foundation Backfill Material

Similar to the discussions pertaining to the backfill under the foundations, backfill around the foundations is also variable, and contains deleterious or frost susceptible material.

Organic or frost susceptible soils used as backfill in direct contact with foundation walls could detrimentally affect drainage and cause frost adhesion to the already weak foundation wall and cause movements.

5.4 Groundwater Effects

The consistent and steady supply of groundwater actively aggravates problems caused by freeze-thaw of founding and backfill materials. In addition, these movements and fluctuations can help mobilize and transport fine material from their original area of placement.

6.0 RECOMMENDATIONS

Considering the above information, three remedial options have been considered:

1. Grouting
2. Conventional Underpinning
3. Foundations to Bedrock

For all three options, the foundation must be backfilled with free draining material, properly placed and compacted. In addition, the foundation and founding soils should be protected from frost penetration.

6.1 Grouting

Grouting would involve the injection of a grout (fine aggregate and cement, with additives) into the underlying voids to solidify the supporting fill. Additional field work by a specialty contractor comprising test grouting will be required to determine the location of the porous fill and its density and the optimum injection solution and methods. Once detailed subsurface conditions are known, a program of sequential grouting could be carried out, where an initial series of holes would be drilled and grouted to "cut-off" the flow of subsequent injections of grout.

This option is weather dependent (use of water in the process is susceptible to freezing), likely to be costly because of the volume of grout required, challenging due to excessive groundwater in the voids, and there will be some uncertainty regarding the complete and consistent treatment of the foundation soils.

An option to control the spread of the grout is provided by sheet pile cutoffs. However, driving sheet piles may not be effective due to the bouldery fill till and uneven bedrock surface and conditions. In these conditions it would be difficult to create adequate sealing on the bedrock surface. In addition, the vibrations during installation may negatively affect the building structure.

6.2 Underpinning

Underpinning consists of small excavations advanced to competent foundation material beneath a predetermined section along the existing foundation, followed by the casting of a concrete block/column to provide future support of the old footing. An equal amount of foundation wall is skipped over and another column poured. Once the new support columns have cured adequately, the sections of soils skipped are replaced with concrete columns. Depending on the condition of the existing footings, temporary bracing may be necessary during the underpinning operations.

Underpinning columns founded on undisturbed native till soil, possibly as deep as 2 m, can be designed using an allowable bearing capacity of 150 kPa. Total and differential settlements will be limited to 25 mm and 19 mm, respectively.

This option is not preferred because of the aerial limitations (proximity of adjacent buildings and other infrastructure) to accommodate deep excavations and obstructions such as existing structures and buried services. Not to mention the masonry structures are very sensitive to differential movement and the foundations walls are suspected to be in an advanced level of deterioration.

The largest challenge with this option is groundwater control. It is anticipated there is a large volume of groundwater and the removal of a large volume, if even possible (as it may be hydraulically connected to the adjacent water bodies), and may detrimentally affect other structures.

Driving sheet piles to control excavation slopes and groundwater may not be effective due to the bouldery fill till and uneven bedrock surface and conditions. In these conditions it would be difficult to create adequate sealing on the bedrock surface. In addition, the vibrations during installation may negatively affect the building structure.

6.3 Foundations to Bedrock

The third option includes installing foundations to bedrock to support the structure. The depth to bedrock, as measured in our test holes, ranged from 2.8 to 3 m depth below existing grade. In fact, the solution is similar to underpinning but instead of open-cut excavations to accommodate concrete block, the foundation loads will be transferred to bedrock via drilled piles. Support beams or foundation wall reinforcement will be required in conjunction with this option. The reinforced foundation will be tied into foundation elements that will be installed down to the bedrock surface. All foundation to bedrock options will require pre-drilling to penetrate the cobbles/boulder and lined holes, to install the foundation elements.

Foundations directly on the bedrock surface can utilize a conservative bearing capacity of 500 kPa. Total and differential settlements will be negligible.

6.3.1 Micro-Piles

The use of proprietary foundation systems can be considered, generically described as “micropiles”, such as helical piers, etc. These micropiles/helical piers will be installed within a lined hole, likely installed by a percussion drill, such as a water well rig. The actual foundation system capacity depends on the specific installation method, size, and spacing, and should be specified by the specialty supplier and proven by field tests. Consideration should be given for compressive, uplift and lateral testing. The depth to bedrock, as measured in our test holes, ranged from 2.8 to 3 m depth below existing grade.

This type of piles could be installed in drilled cased hole, grouted into place and attached to the modified foundation. Also, and if necessary the building can be jacked into place. Windows and doors would likely have to be removed during this operation and the openings reinforced.

We will be happy to assist with further details once the foundation system is finalized. However, the final design should be based on the confirmation of the system’s capacity, on the basis of field load tests.

6.3.2 Drilled Piles

Drilled piles, which include either having a drill shoe on the end of the pile or utilize a collapsible bit that is passed through the pile, may be considered. These piles will be socketed into the bedrock, tapped into place and grouted. The depth to bedrock, as measured in our test holes, ranged from 2.8 to 3 m depth below existing grade. The required sockets should be at least 1 m in depth, resulting in a final depth of around 4 m.

The most suitable pile type will probably consist of heavy walled, high stress steel piles. In principle, the geotechnical capacity of such piles should be close to their allowable structural capacity. As an example, pipe pile with an outside diameter (OD) of 240 mm O.D. x 19 mm wall thickness, with a yield strength of 350 MPa will give a factored ultimate geotechnical resistance of 1850 kN. The actual mobilised pile capacity should be demonstrated by adequate field testing such as pile dynamic analysis (PDA) testing or static load testing. The anticipated allowable geotechnical capacity of a pile driven into a socket in the rock, without structural damage, should be in the order of $0.3F_y$ times the steel area. The settlement of the pile will be generally negligible and limited to the elastic shortening of the pile.

It may be preferable to only state the required pile capacity in the construction tender to potentially take advantage of readily available, lower priced piles (pipe and/or H-piles).

The piles should be designed with increased tolerances for deviations from plumb and location, as piles may deviate due to obstructions in the overburden. As such, normally accepted tolerances in the piling industry of 2% out of plumbness and 75 mm out of location should be increased to larger tolerances.

Once the pile type is chosen and the hammer type/energy are known, a preliminary pile ‘set criteria’ should be selected for achieving the required capacity, when tapping the pile into the bedrock socket.

The preliminary 'set criteria' should be reviewed by this office and should be confirmed in the field by load testing or the use of a PDA during pile driving. An independent full-time piling inspector must confirm the 'set criteria' on each pile. Pile driving should preferably follow O.P.S.S.903 guidelines, particularly during final 'seating' procedures.

Consideration should be given to conducting PDA testing early on the program to confirm design pile capacities. For past projects, PDA testing was conducted initially and during the project, which has allowed for a reduction in the applied factor of safety due to the comfort level of the civil and geotechnical consultant.

6.4 Frost Protection

For foundations elements on soil, as well as, for pile caps (grade beams) it is recommended that exterior foundations or footings for the building be provided with at least 1.8 m of earth cover (or equivalent rigid insulation) for frost protection. Where the insulating effect of snow cover is removed on a continuing basis, e.g., access routes it is recommended this frost cover be increased to 1.95 m.

6.5 Earthquake Considerations

For foundations on native soils, the project sites can be classified as "Site Class D – Dense Soils". The four values of the Spectral response acceleration $S_a(T)$ for different periods and the Peak Ground Acceleration (PGA) can be obtained from Table C-2 in Appendix C, Division B of the NBC (2005). The design values of F_a and F_v for the project site should be calculated in accordance to Table 4.1.8.4 B and C.

Consideration may be given to conducting an earthquake site classification assessment with the use of in-situ testing of the seismic characteristics which may lead to an improved earthquake site classification.

6.6 Excavations

Above the groundwater table, temporary shallow excavations in soil (expected to generally be Type 3 soils) should be stable at 1H: 1V side slopes in accordance with the Ontario Health and Safety Regulations. Seepage from a surface water source should be moderate and if necessary can be handled by gravity drainage and pumping (properly filtered) from open sumps.

However, due to the high groundwater table observed in the test holes, most excavations will likely penetrate the groundwater table and engineered shoring and dewatering will be required. All excavations should be carried out in accordance with the Occupational Health and Safety Regulations of the province. A qualified geotechnical engineer should be retained to review the proposed excavation procedures.

6.7 Reuse of Excavated Soil

The soils that will be removed from excavations around this structure may not be free draining and should not be used where free draining soils are required. However, select native soils and fills that are clean and compactable may be used as structural fills.

6.8 Lateral Earth Pressures

For preliminary design purposes, or for simple retaining structures, the lateral earth pressure, 'p' (kPa), at any depth, 'h' (m) of a permanent earth retaining wall is given by the following expression:

$$p = K (\gamma h + q) + \gamma_w h$$

where:

- p = lateral earth pressure in kPa acting at depth h;
- K = the applicable earth pressure coefficient (see the following table);
- γ = bulk unit weight above the groundwater table;
- h = depth to point of interest in m;
- q = equivalent value of any surcharge load in kPa, if any, acting adjacent to the wall at the ground surface; and,
- γ_w = unit weight of water is 9.81 kN/m³.

Typical Unfactored Soil Properties for Compacted Fills

Soil Type	Angle of Internal Friction Φ Degrees	Soil Unit Weight (γ) kN/m ³	Earth Pressure Coefficients K (note 2, 3)		
			Active (K_a)	Passive (K_p)	At Rest (K_o)
Well Graded Sand & Gravel (Granular B Type I) ⁽¹⁾	31	21.2 to 22	0.32	3.1	0.49
Well Graded Crushed Granular (Granular A, or Granular B Type II) ⁽¹⁾	34	22	0.28	3.5	0.44

Notes:

- 1) Backfill compacted to $\geq 100\%$ SPMDD
- 2) The calculated earth pressures caused by compacted fill, under no circumstances, should be taken as less than 12 kPa in any section of the retaining structure.
- 3) The provided earth pressure coefficients apply to level ground conditions. In the case of sloped ground backfill (like along the west side of the building) increased earth pressure coefficient will be required. Preliminarily, a multiplication factor of $(1 + \sin \beta / \Phi)$ may be considered (β is the slope angle).

The above expression includes a term for hydrostatic pressure from surrounding groundwater. A qualified geotechnical engineer should be retained to evaluate design lateral earth pressures.

Earth pressures for temporary shoring structures are calculated differently, in accordance with the applicable methods specific to the type of shoring used. Our office would be glad to assist with detailed geotechnical recommendations on a case-by-case basis.

6.9 Subdrainage

Subdrainage should be installed at the base of the foundation wall, if the effects of fluctuating groundwater levels is a concern, i.e., depending on the remedial option selected. The Subdrainage system should include standard drainage tile wrapped in filter sock, embedded in filter gravel and connected to proper outlets (catch-basins, manholes, ditches, etc.). It is essential that the drainage outlet be open and operational at all times (i.e., free of ice blocking, debris, etc.).

7.0 CLOSURE

The Limitations of Report, as presented in Appendix C, forms an integral part of this report.

Given the unique nature of the project and complexity of the causes for the structural distress, the subsurface information and geotechnical recommendations provided in this report may not be sufficient to optimize the remedial solution for the building rehabilitation.

Before selection of the foundation repair, a detailed condition survey including intrusive methods and close monitoring of the movement spanning over sufficient length of time should be implemented.

The recommendations included in this report, although site specific, have a general nature. Once the intended design details and construction methods are available, we recommend a geotechnical consultant be retained to review this information to ensure conformance with the assumptions and limitations considered. This is particularly important when it comes to the review of the preferred remedial option, etc.

Rowswell and Associates Engineers Inc.
Geotechnical Test Hole Investigation
Proposed Structural Stabilization of Stores Building
Sault Ste. Marie, Ontario
February 2013



We trust that the information presented in this report is complete within our terms of reference. If you have any questions, please do not hesitate to contact our office.

Respectfully submitted,

AMEC Environment & Infrastructure



Prepared by:
Dan Cacciotti, P.Eng.
Project Engineer

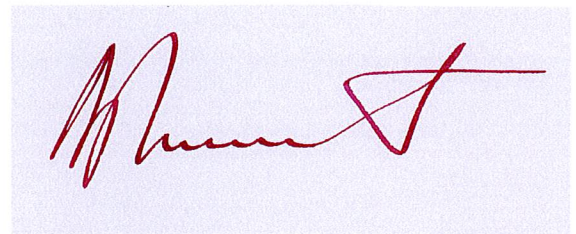

Reviewed by:
Dan Dimitriu, PhD, P.Eng.
Associate Geotechnical Engineer

EXPLANATION OF BOREHOLE LOG

This form describes some of the information provided on the borehole logs, which is based primarily on examination of the recovered samples, and the results of the field and laboratory tests. Additional description of the soil/rock encountered is given in the accompanying geotechnical report.

GENERAL INFORMATION

Project details, borehole number, location coordinates and type of drilling equipment used are given at the top of the borehole log.

SOIL LITHOLOGY

Elevation and Depth

This column gives the elevation and depth of inferred geologic layers. The elevation is referred to the datum shown in the Description column.

Lithology Plot

This column presents a graphic depiction of the soil and rock stratigraphy encountered within the borehole.

Description

This column gives a description of the soil strata, based on visual and tactile examination of the samples augmented with field and laboratory test results. Each stratum is described according to the *Modified Unified Soil Classification System*.

The compactness condition of cohesionless soils (SPT) and the consistency of cohesive soils (undrained shear strength) are defined as follows (*Ref. Canadian Foundation Engineering Manual*):

Compactness of	
<u>Cohesionless</u>	<u>SPT N-Value</u>
<u>Soils</u>	
Very loose	0 to 4
Loose	4 to 10
Compact	10 to 30
Dense	30 to 50
Very Dense	> 50

Consistency of	<u>Undrained Shear Strength</u>	
	<u>Cohesive Soils</u>	
	<u>kPa</u>	<u>psf</u>
Very soft	0 to 12	0 to 250
Soft	12 to 25	250 to 500
Firm	25 to 50	500 to 1000
Stiff	50 to 100	1000 to 2000
Very stiff	100 to 200	2000 to 4000
Hard	Over 200	Over 4000

Soil Sampling

Sample types are abbreviated as follows:

SS	Split Spoon	TW	Thin Wall Open (Pushed)	RC	Rock Core	GS	Grab Sample
AS	Auger Sample	TP	Thin Wall Piston (Pushed)	WS	Washed Sample	AR	Air Return Sample

Additional information provided in this section includes sample numbering, sample recovery and numerical testing results.

Field and Laboratory Testing

Results of field testing (e.g., SPT, pocket penetrometer, and vane testing) and laboratory testing (e.g., natural moisture content, and limits) executed on the recovered samples are plotted in this section.

Instrumentation Installation

Instrumentation installations (monitoring wells, piezometers, inclinometers, etc.) are plotted in this section. Water levels, if measured during fieldwork, are also plotted. These water levels may or may not be representative of the static groundwater level depending on the nature of soil stratum where the piezometer tips are located, the time elapsed from installation to reading and other applicable factors.

Comments

This column is used to describe non-standard situations or notes of interest.

MODIFIED * UNIFIED CLASSIFICATION SYSTEM FOR SOILS
 *The soil of each stratum is described using the Unified Soil Classification System (Technical Memorandum 36-357 prepared by Waterways Experiment Station, Vicksburg, Mississippi, Corps of Engineers, U.S Army, Vol. 1 March 1953.) modified slightly so that an inorganic clay of "medium plasticity" is recognized.

MAJOR DIVISION		GROUP SYMBOL	TYPICAL DESCRIPTION	LABORATORY CLASSIFICATION CRITERIA	
COARSE GRAINED SOILS (MORE THAN HALF BY WEIGHT LARGER THAN 75µm)	GRAVELS MORE THAN HALF THE COARSE FRACTION LARGER THAN 4.75mm	CLEAN GRAVELS (TRACE OR NO FINES)	GW	WELL GRADED GRAVELS, GRAVEL-SAND MIXTURES, LITTLE OR NO FINES	$C_u = \frac{D_{60}}{D_{10}} > 4; C_c = \frac{(D_{30})^2}{D_{10} \times D_{60}} = 1 \text{ to } 3$
			GP	POORLY GRADED GRAVELS, GRAVEL-SAND MIXTURES, LITTLE OR NO FINES	NOT MEETING ABOVE REQUIREMENTS
		DIRTY GRAVELS (WITH SOME OR MORE FINES)	GM	SILTY GRAVELS, GRAVEL-SAND- SILT MIXTURES	ATTERBERG LIMITS BELOW "A" LINE OR P.I MORE THAN 4
			GC	CLAYEY GRAVELS, GRAVEL-SAND-CLAY MIXTURES	ATTERBERG LIMITS BELOW "A" LINE OR P.I MORE THAN 7
	SANDS MORE THAN HALF THE COARSE FRACTION SMALLER THAN 4.75mm	CLEAN SANDS (TRACE OR NO FINES)	SW	WELL GRADED SANDS, GRAVELLY SANDS, LITTLE OR NO FINES	$C_u = \frac{D_{60}}{D_{10}} > 6; C_c = \frac{(D_{30})^2}{D_{10} \times D_{60}} = 1 \text{ to } 3$
			SP	POORLY GRADED GRAVELS, GRAVEL- SAND MIXTURES, LITTLE OR NO FINES	NOT MEETING ABOVE REQUIREMENTS
		DIRTY SANDS (WITH SOME OR MORE FINES)	SM	SILTY SANDS, SAND-SILT MIXTURES	ATTERBERG LIMITS BELOW "A" LINE OR P.I MORE THAN 4
			SC	CLAYEY SANDS, SAND-CLAY MIXTURES	ATTERBERG LIMITS BELOW "A" LINE OR P.I MORE THAN 7
FINE-GRAINED SOILS (MORE THAN HALF BY WEIGHT SMALLER THAN 75µm)	SILTS BELOW "A" LINE NEGLIGIBLE ORGANIC CONTENT	$W_L < 50\%$	ML	INORGANIC SILTS AND VERY FINE SANDS, ROCK FLOUR, SILTY SANDS OF SLIGHT PLASTICITY	CLASSIFICATION IS BASED UPON PLASTICITY CHART (SEE BELOW)
		$W_L < 50\%$	MH	INORGANIC SILTS, MICACEOUS OR DIATOMACEOUS, FINE SANDY OR SILTY SOILS	
	CLAYS ABOVE "A" LINE NEGLIGIBLE ORGANIC CONTENT	$W_L < 30\%$	CL	INORGANIC CLAYS OF LOW PLASTICITY, GRAVELLY, SANDY OR SILTY CLAYS, LEAN CLAYS	
		$30\% < W_L < 50\%$	CI	INORGANIC CLAYS OF MEDIUM PLASTICITY, SILTY CLAYS	
		$W_L < 50\%$	CH	INORGANIC CLAYS OF HIGH PLASTICITY, FAT CLAYS	
	ORGANIC SILTS & CLAYS BELOW "A" LINE	$W_L < 50\%$	OL	ORGANIC SILTS AND ORGANIC SILTY CLAYS OF LOW PLASTICITY	WHENEVER THE NATURE OF THE FINES CONTENT HAS NOT BEEN DETERMINED, IT IS DESIGNATED BY THE LETTER "F", E.G SF IS A MIXTURE OF SAND WITH SILT OR CLAY
		$W_L < 50\%$	OH	ORGANIC CLAYS OF HIGH PLASTICITY	
	HIGH ORGANIC SOILS		Pt	PEAT AND OTHER HIGHLY ORGANIC SOILS	STRONG COLOUR OR ODOUR, AND OFTEN FIBROUS TEXTURE

SOIL COMPONENTS					
FRACTION	U.S STANDARD SIEVE SIZE	DEFINING RANGES OF PERCENTAGE BY WEIGHT OF MINOR COMPONENTS			
		PASSING	RETAINED	PERCENT	DESCRIPTOR
GRAVEL	COARSE	75 mm	19 mm	35-50	AND
				20-35	Y/EY
	FINE	19 mm	4.75 mm	10-20	SOME
SAND	COARSE	4.75 mm	2.00 mm	1-10	TRACE
	MEDIUM	2.00 mm	425 µm		
	FINE	425 µm	75 µm		
FINES (SILT OR CLAY BASED ON PLASTICITY)		75 µm			
OVERSIZED MATERIAL					
ROUNDED OR SUBROUNDED: COBBLES 75 mm to 300 mm BOULDERS > 300 mm				NOT ROUNDED: ROCK FRAGMENTS > 76 mm ROCKS > 0.76 CUBIC METRE IN VOLUME	

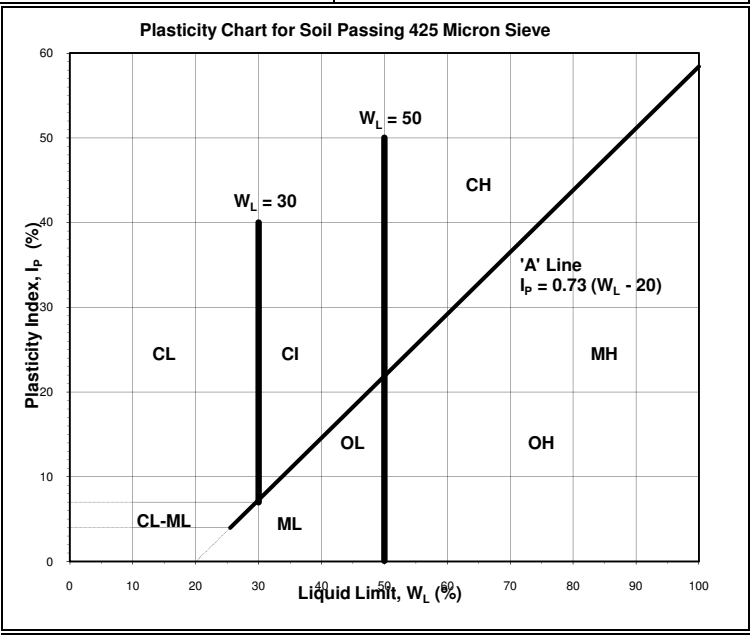

AMEC Environment & Infrastructure
 131 Fielding Rd.
 Lively, ON P3Y 1L7
 Ph: (705) 682-2632
 Fax: (705) 682-2260
 www.amec.com



Note 1: Soils are classified and described according to their engineering properties and behaviour.
 Note 2: The modifying adjectives used to define the actual or estimated percentage range by weight of minor components are consistent with the Canadian Foundation Engineering Manual (3rd Edition, Canadian Geotechnical Society, 1992.)
 Rev. March 2012



Rowswell & Associates, Engineers Inc.		DWN BY:	PROJECT Geotechnical Test Hole Investigation Proposed Structural Stabilization of Stores Building Sault Ste. Marie, Ontario	REV. NO.:	A
		CHK'D BY:		DATE:	January 2013
AMEC Environment & Infrastructure 131 Fielding Road Lively, Ontario P3Y 1L7 705-682-2632		SCALE:	TITLE:	PROJECT NO.:	TY123028
		as shown	Site Location Map	FIGURE NO.:	1

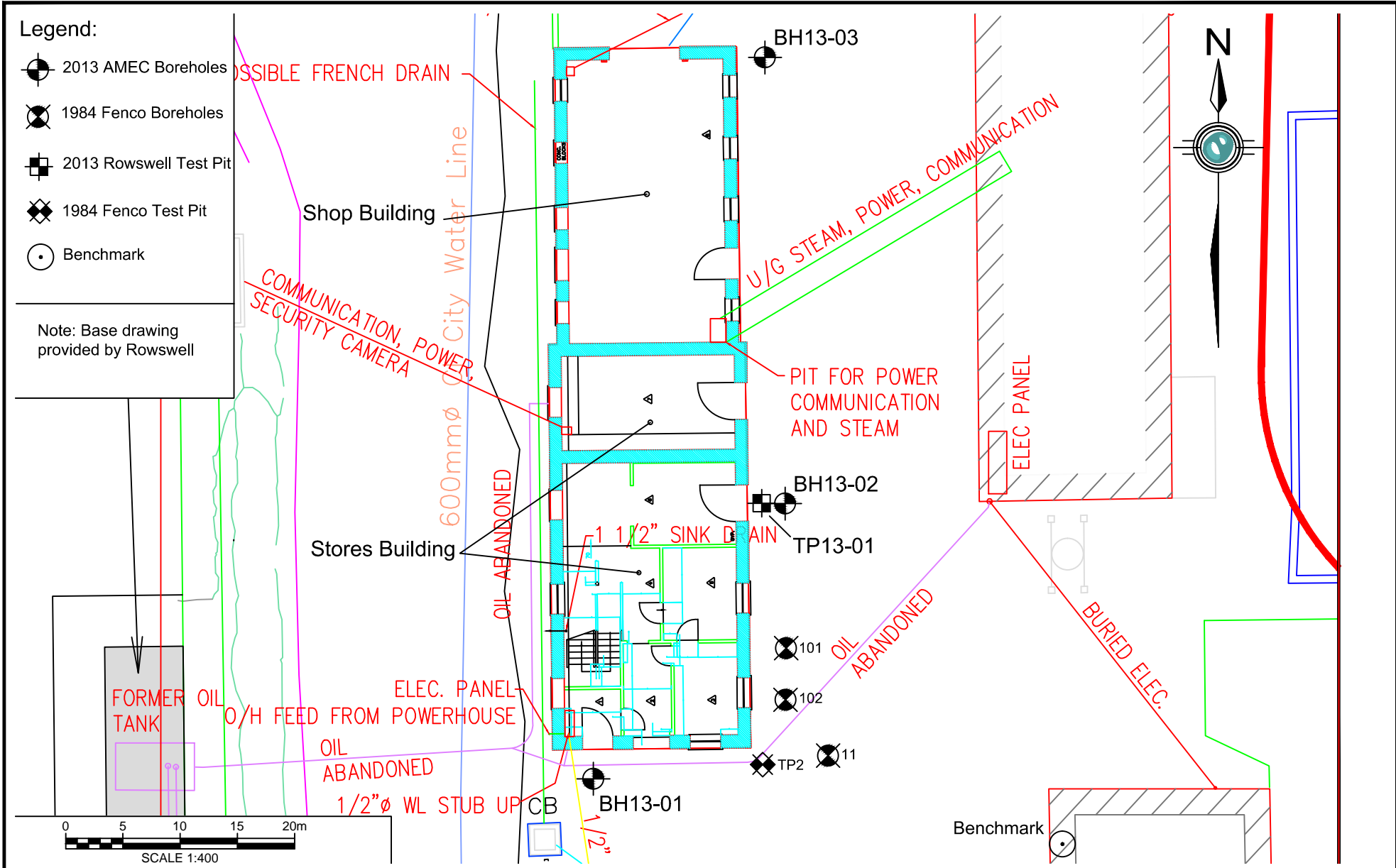

Rowswell & Associates, Engineers Inc.	DWN BY:	PROJECT	REV. NO.: A	
	KJW			Geotechnical Test Hole Investigation Proposed Structural Stabilization of Stores Building Sault Ste. Marie, Ontario
AMEC Environment & Infrastructure 131 Fielding Road Lively, Ontario P3Y 1L7 705-682-2632	CHK'D BY:	TITLE	PROJECT NO.: TY123028	
	DMB		Test Hole Location Plan	FIGURE NO.:
	SCALE: as shown			2

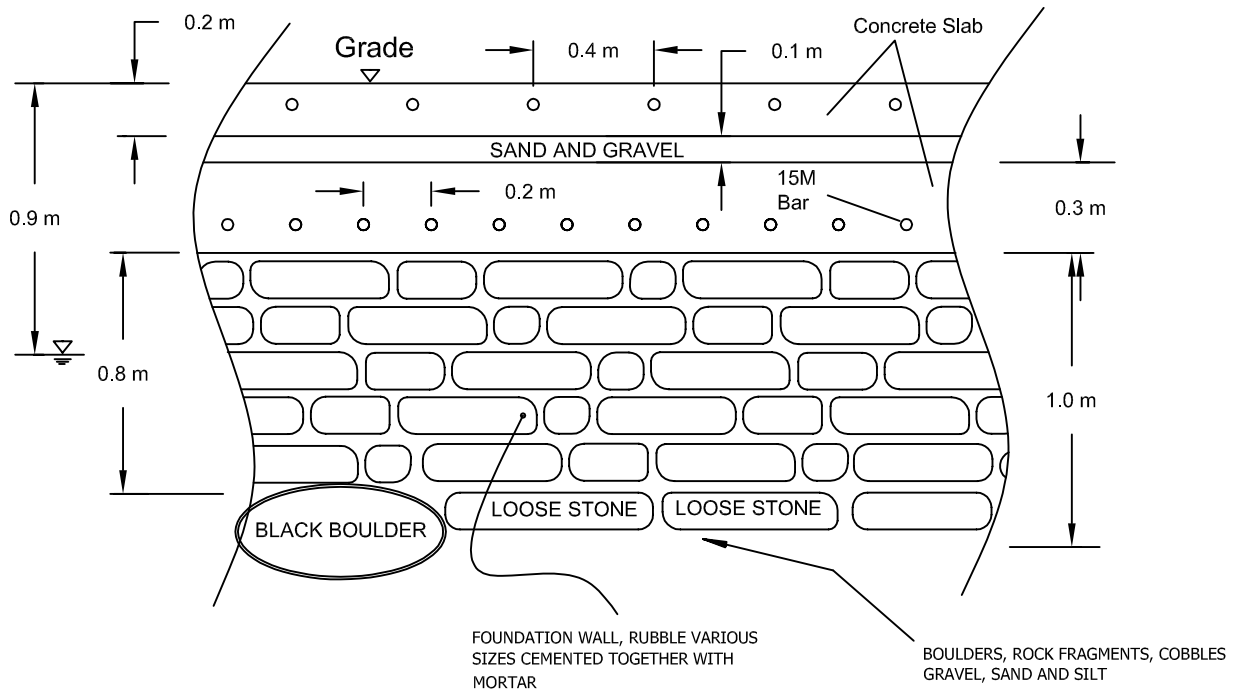

Table 1 – Test Pit Data

Test Pit No.	Co-ordinates NAD 86, 16T	Depth (m)	Soil Description and Comments
TP13-01	703313E, 5154489N	0 – 0.55 0.55 – 1.6 1.6	CONCRETE SLAB-ON-GRADE Brown and black, FILL, mostly sand, some gravel, trace silt / clay, occasional cobbles / boulders, organics, moist to wet END OF TEST PIT due to excessive water seepage within the test pit location.

NOTE:

1. WATER SEEPAGE OBSERVED AT 0.9 M BELOW THE GROUND SURFACE.
2. EXISTING FOUNDATION DETAILS PROVIDED BY ROWSWELL & ASSOCIATES, ENGINEERS INC.

AMEC Environment & Infrastructure 131 Fielding Road Lively, Ontario P3Y 1L7 705-682-2632				Rowswell & Associates, Engineers Inc.	
PROJECT Geotechnical Test Hole Investigation Proposed Structural Stabilization of Stores Building Sault Ste. Marie, Ontario			DWN BY: KJW	CHK'D BY: DMB	DATE: January 2013
TITLE Existing Foundation Details			REV. NO.: 1	SCALE: as shown	PROJECT NO: TY123028 FIGURE NO: 3

GRAIN SIZE DISTRIBUTION ANALYSIS (ASTM D 422) UNIFIED SOIL CLASSIFICATION SYSTEM

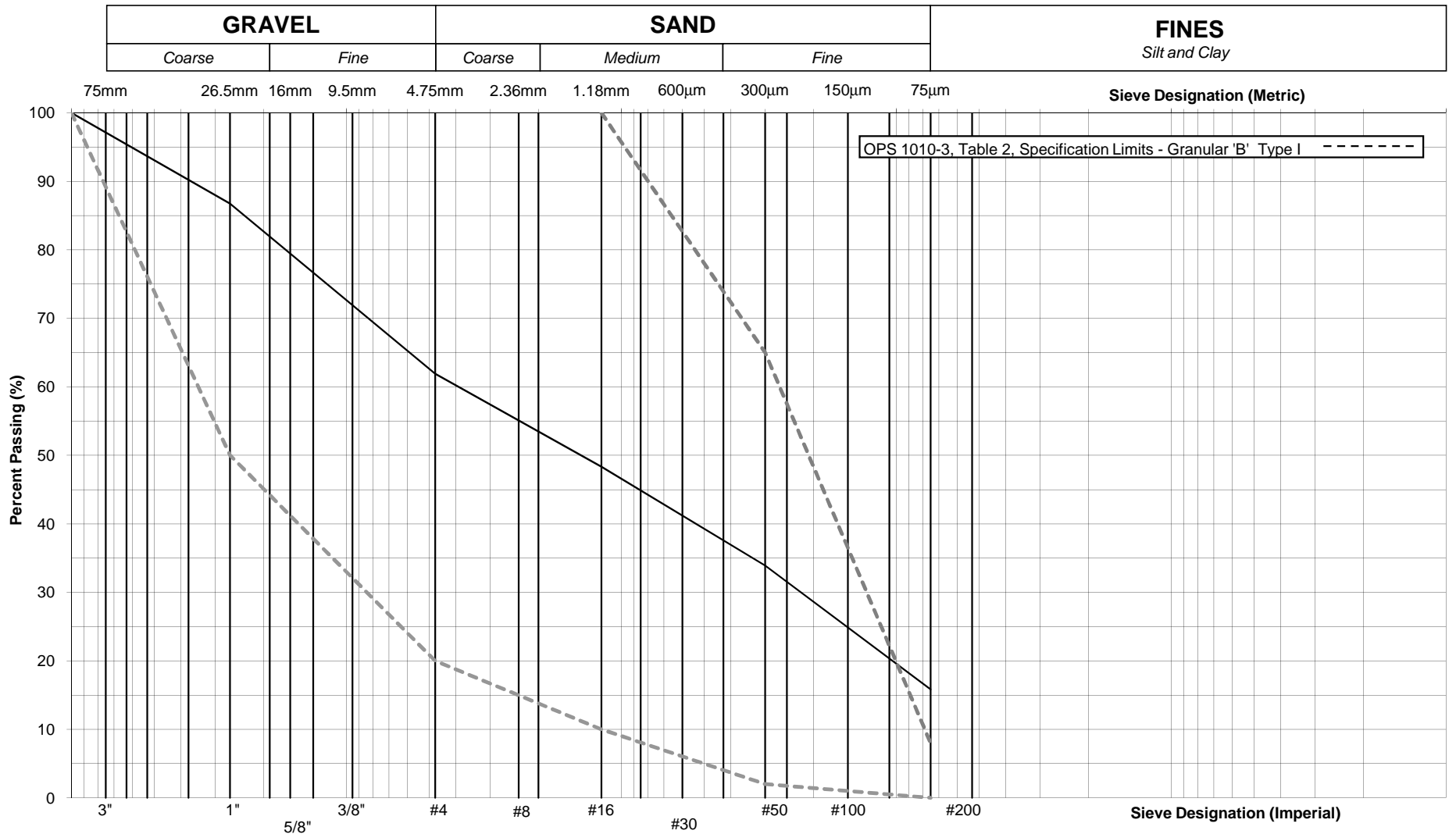

CLIENT LOGO:

CLIENT NAME:
**Rowswell & Associates,
 Engineers Inc.**

SAMPLED BY:
 AM Poplawski, AMEC

RECEIVED BY:
 PF Guenette, AMEC

TESTED BY:
 PF Guenette, AMEC

DATE:
 14-Jan-13

PROJECT:
**Geotechnical Test Hole Investigation
 Proposed Structural Stabilization of Stores Building
 Sault Ste. Marie, Ontario**

Sample Location:
BH13-01 SS5

Sample Identification:
SAND & GRAVEL, some silt

REV. No.:

LAB No.:
SB13018

PROJECT No.:
TY123028

FIGURE No.:
4

GRAIN SIZE DISTRIBUTION ANALYSIS (ASTM D 422) UNIFIED SOIL CLASSIFICATION SYSTEM

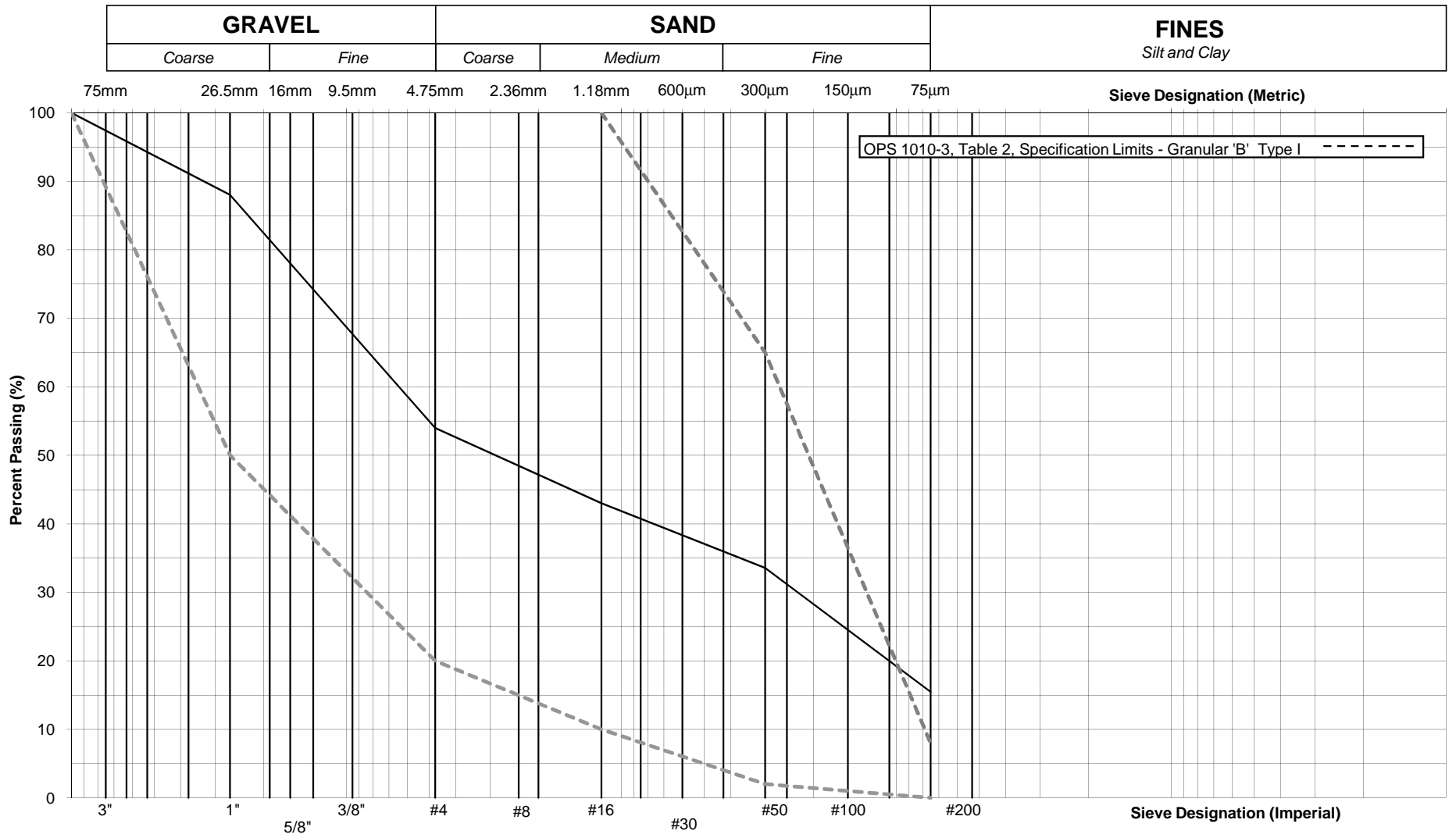

CLIENT LOGO:

CLIENT NAME:
**Rowswell & Associates,
 Engineers Inc.**

SAMPLED BY:
 AM Poplawski, AMEC

RECEIVED BY:
 PF Guenette, AMEC

TESTED BY:
 PF Guenette, AMEC

DATE:
 14-Jan-13

PROJECT:
**Geotechnical Test Hole Investigation
 Proposed Structural Stabilization of Stores Building
 Sault Ste. Marie, Ontario**

Sample Location:
BH13-03 SS2

Sample Identification:
SAND & GRAVEL, some silt

REV. No.:

LAB No.:
SB13019

PROJECT No.:
TY123028

FIGURE No.:
5

Rowswell and Associates Engineers Inc.
Geotechnical Test Hole Investigation
Proposed Structural Stabilization of Stores Building
Sault Ste. Marie, Ontario
February 2013



APPENDIX A
PREVIOUS GEOTECHNICAL REPORTS

Rowswell and Associates Engineers Inc.
Geotechnical Test Hole Investigation
Proposed Structural Stabilization of Stores Building
Sault Ste. Marie, Ontario
February 2013



APPENDIX B
BOREHOLE LOGS

RECORD OF BOREHOLE No. **BH13-01** Co-Ord. **0703309 E, 5154487 N**



Project Number: **TY123028** Drilling Location: **Existing Stores Building - Southwest Corner** Logged by: **AMP**
 Project Client: **Rowswell & Associates, Engineers Inc.** Drilling Method: **200 mm Hollow Stem Augers** Compiled by: **KJW**
 Project Name: **Proposed Structural Stabilization of Stores Building** Drilling Machine: **Track Mounted Drill** Reviewed by: **DMB**
 Project Location: **Sault Ste. Marie, Ontario** Date Started: **Jan 9, 13** Date Completed: **Jan 9, 13** Revision No.: **1, 1/17/13**

Lithology Plot	LITHOLOGY PROFILE		SOIL SAMPLING				FIELD TESTING		LAB TESTING				INSTRUMENTATION INSTALLATION	COMMENTS	
	DESCRIPTION	ELEVATION (m)	Sample Type	Sample Number	Recovery (%)	SPT 'N' Value	DEPTH (m)	ELEVATION (m)	Penetration Testing ○ SPT ● DCPT △ Intact ◇ Intact ▲ Remould ◆ Remould * Undrained Shear Strength (kPa) 15 30 45 60	Atterberg Limits W _p W L _p Plastic Liquid * Passing 75 um (%) ○ Moisture Content (%)	20	40			60
	Local Ground Surface Elevation: 99.9 m														
	225 mm CONCRETE over														
	brown and black FILL mostly sand, some gravel, silt/ clay trace organics inferred cobbles / boulders	98.5	AU	1			0.5	99.0		○ 7					
			SS	2	67	50/150mm		1.0	99.0		○ 3				
	cobble / boulder observed during coring at 1.2 to 1.5 m depth		SS	3	50	50/50mm		1.0	99.0		○ 10				
		98.4	RC	4				1.5	98.5						
	brown to red SAND and GRAVEL some silt, trace clay moist, very dense	1.5	SS	5	75	60		2.0	98.0		○ 11				
			SS	6	56	88		2.5	97.5		○ 88	○ 11			
	END OF SAMPLING	96.9						3.0	97.0						
	START OF CORING	3.0						3.0	97.0						
	red to grey SANDSTONE, SHALE, CONGLOMERATE		RC	7	99			3.5	96.5						
TCR = 99% SCR = 17% RQD = 26%							4.0	96.0							
		RC	8	57			4.5	95.5							
TCR = 57% SCR = 0.7% RQD = 0.0%							5.0	95.0							
		RC	9	97			6.0	94.0							
TCR = 97% SCR = 93% RQD = 69%							6.5	93.5							
		RC	10	98			7.5	92.5							
TCR = 98% SCR = 92% RQD = 54%							8.0	92.0							
END OF CORING	91.3						8.5	91.5							
	8.7														

AMEC Environment & Infrastructure
 A Division of AMEC Americas Limited
 131 Fielding Road
 Lively, Ontario
 Canada P3Y 1L7
 Tel +1(705) 682-2632
 Fax +1(705) 682-2260
 www.amec.com

▽ Groundwater depth on completion of drilling: 2.1 m.
 ▽ Groundwater depth recorded on 1/9/2013 4:45:00 PM at a depth of 0.3 m ☒ Cave in depth recorded 1/9/2013 4:45:00 PM at a depth of 0.4 m.

Borehole details as presented, do not constitute a thorough understanding of all potential conditions present and requires interpretative assistance from a qualified Geotechnical Engineer. Also, borehole information should be read in conjunction with the geotechnical report for which it was commissioned and the accompanying 'Explanation of Borehole Log'.

RECORD OF BOREHOLE No. **BH13-02** Co-Ord. **0703316 E, 5154500 N**



Project Number: **TY123028** Drilling Location: **Existing Stores Building - East Side** Logged by: **AMP**
 Project Client: **Rowswell & Associates, Engineers Inc.** Drilling Method: **200 mm Hollow Stem Augers** Compiled by: **KJW**
 Project Name: **Proposed Structural Stabilization of Stores Building** Drilling Machine: **Track Mounted Drill** Reviewed by: **DMB**
 Project Location: **Sault Ste. Marie, Ontario** Date Started: **Jan 10, 13** Date Completed: **Jan 10, 13** Revision No.: **1, 1/17/13**

Lithology Plot	LITHOLOGY PROFILE	SOIL SAMPLING				FIELD TESTING		LAB TESTING		INSTRUMENTATION INSTALLATION	COMMENTS
	DESCRIPTION	Sample Type	Sample Number	Recovery (%)	SPT 'N' Value	DEPTH (m)	ELEVATION (m)	Penetration Testing ○ SPT ● DCPT MTO Vane* Nilcon Vane* △ Intact ◇ Intact ▲ Remould ◆ Remould * Undrained Shear Strength (kPa) 15 30 45 60	Atterberg Limits W _p W L Plastic Liquid ○ 19 ○ 47 * Passing 75 um (%) ○ Moisture Content (%)		
	Local Ground Surface Elevation: 100.0 m										
	300 mm CONCRETE over										
	brown and black FILL mostly sand, some gravel, silt/ clay trace organics inferred cobbles / boulders	AU	1			0.8	99.5				
		SS	2	80	50/150mm	1.0	99.0				
						1.5	98.5				
						2.0	98.0				
	98.0					2.5	97.5				
	brown to red SAND and GRAVEL some silt, trace clay moist					2.0	98.0				
	2.0					2.5	97.5				
	END OF SAMPLING					3.0	97.0				
	97.2					3.5	96.5				
	START OF CORING					4.0	96.0				
	2.8					4.5	95.5				
	red to grey SANDSTONE, SHALE, CONGLOMERATE	RC	3	100		3.5	96.5				
	TCR = 100% SCR = 57% RQD = 15%					4.0	96.0				
		RC	4	59		4.5	95.5				
	TCR = 59% SCR = 37% RQD = 33%					5.0	95.0				
		RC	5	92		5.5	94.5				
	TCR = 92% SCR = 84% RQD = 72%					6.0	94.0				
						6.5	93.5				
	92.9					7.0	93.0				
	END OF CORING										
	7.1										

AMEC Environment & Infrastructure
 A Division of AMEC Americas Limited
 131 Fielding Road
 Lively, Ontario
 Canada P3Y 1L7
 Tel +1(705) 682-2632
 Fax +1(705) 682-2260
 www.amec.com

▽ Groundwater depth on completion of drilling: 0.4 m. ■ Cave in depth recorded on completion of drilling at 1.0 m.

Borehole details as presented, do not constitute a thorough understanding of all potential conditions present and requires interpretative assistance from a qualified Geotechnical Engineer. Also, borehole information should be read in conjunction with the geotechnical report for which it was commissioned and the accompanying 'Explanation of Borehole Log'.

Scale: 1 : 50
Page: 1 of 1

RECORD OF BOREHOLE No. BH13-03 Co-Ord. 0703316 E, 5154516 N



Project Number: TY123028 Drilling Location: Existing Stores Building - Northeast Corner Logged by: AMP
 Project Client: Rowswell & Associates, Engineers Inc. Drilling Method: 200 mm Hollow Stem Augers Compiled by: KJW
 Project Name: Proposed Structural Stabilization of Stores Building Drilling Machine: Track Mounted Drill Reviewed by: DMB
 Project Location: Sault Ste. Marie, Ontario Date Started: Jan 10, 13 Date Completed: Jan 10, 13 Revision No.: 1, 1/17/13

Lithology Plot	LITHOLOGY PROFILE DESCRIPTION	SOIL SAMPLING				DEPTH (m)	ELEVATION (m)	FIELD TESTING	LAB TESTING	INSTRUMENTATION INSTALLATION	COMMENTS
		Sample Type	Sample Number	Recovery (%)	SPT 'N' Value						
	Local Ground Surface Elevation: 100.0 m										
	300 mm CONCRETE over brown and black FILL	AU	1			0.6	99.5				
	mostly sand, some gravel, silt/ clay trace organics inferred cobbles / boulders					0.7	99.3				
	brown to red SAND and GRAVEL some silt, trace clay moist, very dense	SS	2	59	30	1.0	99.0				
						1.5	98.5				
		SS	3	75	40	2.0	98.0				
	END OF SAMPLING					2.5	97.5				
	START OF CORING					3.0	97.0				
	red to grey SANDSTONE, SHALE, CONGLOMERATE	RC	4	76		3.5	96.5				
	TCR = 76% SCR = 25% RQD = 22%					4.0	96.0				
						4.5	95.5				
	TCR = 42% SCR = 0.1% RQD = 0.1%	RC	5	42		5.0	95.0				
						5.5	94.5				
						6.0	94.0				
	TCR = 82% SCR = 75% RQD = 35%	RC	6	82		6.5	93.5				
						7.0	93.0				
						7.5	92.5				
	TCR = 100% SCR = 97% RQD = 93%	RC	7	100		8.0	92.0				
						8.5	91.5				
	END OF CORING					8.6	91.4				

AMEC Environment & Infrastructure
 A Division of AMEC Americas Limited
 131 Fielding Road
 Lively, Ontario
 Canada P3Y 1L7
 Tel +1(705) 682-2632
 Fax +1(705) 682-2260
 www.amec.com

Groundwater depth on completion of drilling: 0.6 m.

Cave in depth recorded on completion of drilling at 1.6 m.

Borehole details as presented, do not constitute a thorough understanding of all potential conditions present and requires interpretative assistance from a qualified Geotechnical Engineer. Also, borehole information should be read in conjunction with the geotechnical report for which it was commissioned and the accompanying 'Explanation of Borehole Log'.

Rowswell and Associates Engineers Inc.
Geotechnical Test Hole Investigation
Proposed Structural Stabilization of Stores Building
Sault Ste. Marie, Ontario
February 2013



APPENDIX C

LIMITATIONS OF REPORT

AMEC ENVIRONMENT & INFRASTRUCTURE

LIMITATIONS OF REPORT

The conclusions and recommendations given in this report are based on information determined at the test hole locations. The information contained herein in no way reflects on the environmental aspects of the project, unless otherwise stated. Subsurface and groundwater conditions between and beyond the test holes may differ from those encountered at the test hole locations, and conditions may become apparent during construction, which could not be detected or anticipated at the time of the site investigation. It is recommended practice that the geotechnical engineer be retained during construction to confirm that the subsurface conditions throughout the site do not deviate materially from those encountered in boreholes.

The design recommendations given in this report are applicable only to the project described in the text and then only if constructed substantially in accordance with the details stated in this report. Since all details of the design may not be known, we recommend that we be retained during the final design stage to verify that the design is consistent with our recommendations, and that assumptions made in our analysis are valid.

The comments made in this report on potential construction problems and possible methods are intended only for the guidance of the designer. The number of test holes may not be sufficient to determine all the factors that may affect construction methods and costs. For example, the thickness of surficial topsoil or fill layers may vary markedly and unpredictably. The contractors bidding on this project or undertaking the construction should, therefore, make their own interpretation of the factual information presented and draw their own conclusions as to how the subsurface conditions may affect their work. This work has been undertaken in accordance with normally accepted geotechnical engineering practices. No other warranty is expressed or implied.

Any use which a third party makes of this report, or any reliance on or decisions to be made based on it, are the responsibility of such third parties. AMEC accepts no responsibility for damages, if any, suffered by any third party as a result of decisions made or actions based on this report.

Rowswell and Associates Engineers Inc.
Additional Geotechnical Test Hole Investigation
Proposed Structural Stabilization of Stores Building
Sault Ste. Marie, Ontario
March 2014



APPENDIX B
PREVIOUS GEOCON REPORTS

T10829

HEAD OFFICE
FILE COPY

REPORT TO
FENCO ENGINEERS INC.
SAULT STE. MARIE ONTARIO
GEOTECHNICAL INVESTIGATION
GROUND SUBSIDENCE
PARKS CANADA
ST. MARY'S ISLAND
SAULT STE. MARIE ONTARIO

Distribution:

- 4 copies - Fenco Engineers Inc.
- 1 copy - Warnock Hersey Professional Services Limited
Sudbury
- 2 copies - Geocon Inc.

September, 1984

GEOCON

TABLE OF CONTENTS

	<u>Page</u>
1.0 PROCEDURE	2
2.0 SUBSURFACE SOIL CONDITIONS	3
2.1 Pumphouse and Stores Building (Boreholes 101 to 103)	3
2.1.1 Organics Mixed with Sand and Gravel	3
2.1.2 Loose to Compact Reddish Brown Till Fill	4
2.1.3 Compact to Very Dense Reddish Brown to Pink Silty Sand and Gravel Till	5
2.1.4 Sandstone Bedrock	5
2.2 Canalman's Shelter (Borehole 104)	6
2.2.1 Sand and Gravel Fill	6
2.2.2 Compact to Dense Reddish Brown to Brown Silty Sand to Gravel Till	6
3.0 GROUNDWATER CONDITIONS	6
4.0 SITE CONDITIONS AND BACKGROUND INFORMATION	7
5.0 DISCUSSION	16
5.1 Area Near Canalman's Shelter	17
5.1.1 Cause of Settlements	17
5.1.2 Remedial Measures	19
5.1.2.1 Underpinning	20
5.1.2.2 Grouting	23
5.2 Area Near Stores and Pumphouse Buildings	22
5.2.1 Cause of Settlements	22
5.2.2 Remedial Measures	22
6.0 CLOSURE	25

TABLE OF CONTENTS (cont'd)

APPENDIX I

Boring Logs

APPENDIX II

Topographic Maps of St. Mary's
Island from 1888 to 1946

APPENDIX III

Piezometric Observations in
Great Lakes Power Limited
Piezometers for 1982-1983



Geocon

GEOTECHNICAL CONSULTANTS

GEOCON INC.
3210 AMERICAN DRIVE, MISSISSAUGA
ONTARIO, CANADA L4V 1B3
TELEPHONE: (416) 673-1584
TELEX: 00-9689C1

September 10th, 1984

Fenco Engineers Inc.;
Station Tower;
421 Bay Street;
Sault Ste. Marie, Ontario.
P6A 1X3.

Attention: Mr. D.B. Bazeley, P.Eng.;
Branch Manager.

Re: GEOTECHNICAL INVESTIGATION
GROUND SUBSIDENCE
PARKS CANADA
ST. MARY'S ISLAND;
SAULT STE. MARIE, ONTARIO.

Gentlemen:

This letter reports the results of the geotechnical investigation carried out for the above noted project. This work was carried out in general accordance with our proposal dated May 25th, 1984 and as defined in subsequent telephone conversations.

The purpose of this investigation was to define the subsurface soil and groundwater conditions across the site where ground subsidences have occurred in the past. This information would be used to aid in the definition of the mechanism which has caused the subsidences, and to aid in the provision of general comments and recommendations pertaining to remedial measures.

Lavalin

1.0 PROCEDURE

The field work for this investigation was carried out during the period of July 17th to 19th, 1984 when a total of four boreholes, numbered 101 to 104, was put down. All boreholes were put down by a Bombardier mounted CME power auger drill to depths ranging from 4.19 to 6.10 m. Bedrock was cored in BQ size in Boreholes 101 to 103 over lengths ranging from 1.22 to 1.60 m.

Sampling was carried out continuously within the overburden from the ground surface or from beneath the concrete pavement using a standard 51 mm O.D. split spoon sampler in conjunction with a Standard Penetration Test. All recovered samples were examined in the field before being transported to our Sudbury Soil Mechanics Laboratory for further examination. Detailed records of the boreholes were prepared and may be seen in Appendix I of this report. All samples remaining after examination will be stored until July 1985, at which time they will be discarded unless we are otherwise instructed by you.

The boreholes were located in the field by Geocon personnel with respect to the existing structures and were generally put down at or near areas of greatest ground subsidence or distress to structures. Some of the boreholes were put down at locations somewhat different from the

initially proposed locations in order to comply with Parks Canada's instructions. In particular it was intended to put down Borehole 102 about 5 to 8 m further south than the actual drilled location. Also it was intended to put down a test pit at the southeast corner of the Stores Building during the investigation to determine the type of foundation which supports this building and to observe "en-masse" the nature of the fill and natural soil types in that area. However excavation of test pits was not permitted by Parks Canada. In addition, no boreholes were put down at the south end of the Canalman's Shelter due to the presence of the penstock at that location. The ground surface elevations at the borehole locations were determined by Fenco personnel with respect to Geodetic datum. The locations of the boreholes, together with the inferred stratigraphy are included on Drawing T10829-1 located at the rear of this report.

2.0 SUBSURFACE SOIL CONDITIONS

The following subsurface conditions were encountered at the borehole locations. For ease of comprehension, the conditions at the two areas studied are discussed separately.

2.1 Pumphouse and Stores Building (Boreholes 101 to 103)

2.1.1 Organics Mixed with Sand and Gravel

Underlying a surficial concrete pavement, 0.46 and 0.51 m thick in Boreholes 101 and 102, respectively, a layer of

Fenco Engineers Inc.,
September 10th, 1984
Page 4.

organics mixed with sand and gravel was encountered. This layer was observed to be 0.15 and 0.31 m thick in these boreholes, respectively.

2.1.2 Loose to Compact Reddish Brown Till Fill

Underlying a surficial 0.15 m thick concrete pavement in Borehole 103 a layer of reddish brown silty sand and gravel till fill was encountered. This deposit was observed to continue to a depth of 3.20 m. Although the samples recovered from this borehole comprised till fill, it is expected that the overall fill layer also contains large boulders and may in fact consist mainly of rock fill as discussed later in Section 4.0 of this report. The presence of boulders was inferred based on observations made in Borehole 103. When Sample 4 from this borehole was attempted, the split spoon sampler and rods fell under self weight after one blow of the drive hammer was applied. This is inferred to represent a void which was created by the fill "arching" over two adjacent pieces of blast rock or boulder fill.

Standard Penetration Tests carried out within this deposit yielded "N" values which ranged from 3 to 16, thereby indicating a very loose to compact state of relative density. The apparent void encountered in conjunction with Sample 4 would also indicate that the fill was likely placed randomly without compaction and thus other similar zones could be expected in the overall fill layer.

2.1.3 Compact to Very Dense Reddish Brown to
Pink Silty Sand And Gravel Till

Underlying the organics layer in Boreholes 101 and 102 at a depth of 0.61 and 0.81 m, respectively, and beneath the fill layer in Borehole 103 at a depth of 3.20 m a stratum of reddish brown to pink silty sand and gravel till was encountered. It is possible, however, that the upper portions of this stratum were, in fact, till fill borrowed from neighbouring locations. This stratum was observed to continue to depths ranging from 2.59 to 4.88 m.

Standard Penetration Tests carried out within this deposit yielded "N" values which ranged from 16 to 95, thereby indicating a compact to very dense state of relative density.

2.1.4 Sandstone Bedrock

Underlying the till stratum in all three boreholes at depths ranging from 2.57 to 4.88 m sandstone bedrock was encountered. All boreholes were terminated in this formation at depths ranging from 4.19 to 6.10 m.

Rock recoveries ranged from 66 to 85 percent averaging 77 percent; whereas rock quality designation* (R.Q.D.) values ranged from 18 to 29 percent, averaging 24 percent, indicating rock of very poor to poor quality.

* See explanation sheet before Boring Logs in Appendix I of this report.

2.2 Canalman's Shelter (Borehole 104)

2.2.1 Sand and Gravel Fill

Surficially, a deposit of sand and gravel fill 0.61 m thick was encountered. A single Standard Penetration Test carried out within this material yielded an "N" value of 4, thereby indicating a loose state of relative density.

2.2.2 Compact to Dense Reddish Brown to Brown Silty Sand to Gravel Till

Underlying the fill deposit a stratum of reddish brown to brown silty sand and gravel till was encountered. It is possible that the upper portions of this layer were till fill borrowed from neighbouring locations. Borehole 104 was terminated within this stratum at a depth of 4.89 m.

Standard Penetration Tests carried out within this stratum yielded "N" values which ranged from 11 to 67. The higher "N" values are considered to have been influenced by larger gravel sized pieces, and are thus not representative. Thus this deposit is inferred to be in a generally compact to dense state of relative density.

3.0 GROUNDWATER CONDITIONS

On July 18th, 1984 the water level in the open holes at the locations of Boreholes 101 and 102 was observed to be at a

depth of 0.87 m. No water levels were observed in Boreholes 103 and 104. The groundwater levels throughout St. Mary's Island are expected to fluctuate seasonally. Also water levels would be influenced by the raising and lowering of the water level in the Lock and by the drop in St. Mary's River level across the Lock. Further comments regarding groundwater conditions are made later in this report.

4.0 SITE CONDITIONS AND BACKGROUND INFORMATION

The site is bounded to the south by the Canadian Lock and to the north by the Great Lakes Power Limited power canal. Great Lakes Power Limited operates a hydroelectric generating facility northeast of the site. According to Parks Canada personnel, historical records indicate that prior to the lock construction about a century ago, the present east end of St. Mary's Island was once a series of smaller islands. It is understood that the channels between the islands were filled with blast rock excavated from the Lock to form the east end of the present Island. A series of maps illustrating the evolution of the topography in the vicinity of St. Mary's Island over the last 100 years have been obtained from the Sault Museum and these maps are included for reference in Appendix II of this Report. As shown by comparison between the maps showing conditions of 1888 and conditions of 1946, the above information would appear to be confirmed. However the old maps are not of

Fenco Engineers Inc.,
September 10th, 1984
Page 8.

sufficient detail and accuracy to precisely determine the original shoreline configuration in the immediate vicinity of the site.

Various structures have been erected on St. Mary's Island pertaining to the Lock operations, including Administration Building, Canalman's Shelter, Stores Building and Pumphouse. Some of these structures (e.g. Pumphouse) are founded directly on bedrock whilst other structures (e.g. Canalman's Shelter and Stores Building) are founded within natural soil strata or within fill deposits. These structures are constructed of sandstone blocks and mortar. It is likely that these structures were built shortly after construction of the Lock.

It is understood that during recent excavations between the existing Canalman's Shelter and Motorhouse No. 2, a void up to approximately 100 mm deep was exposed under the adjacent concrete walkways. Further examination of the Shelter and other buildings within the area was then carried out. The inspection revealed that the Shelter and also the Stores Building, which is located on the lower level, have experienced cracking of the natural exterior blocks of sandstone and/or through the mortar joints. The southwest and southeast corners of the Shelter and Stores Building, respectively, have also experienced greater differential settlement with respect to the other corners of the respective

Fenco Engineers Inc.,
September 10th, 1984
Page 9.

buildings. For the Stores Building only the south part of this building has experienced noticeable cracking due to settlement. Also, the concrete pavement in the parking lot area between the Stores Building and the existing Pumphouse has experienced differential settlement. The Pumphouse, which is understood to be constructed directly on bedrock, has not undergone similar cracking and/or movement.

In addition to the above observations, it is understood that when work was being carried out on the tailrace floor below the Great Lakes Power Limited Power House, a void beneath the tailrace floor was discovered that was large enough to permit access to a workman. Furthermore, it is understood that during the spring thaw, sink holes open up at random locations across St. Mary's Island. These sink holes are understood to be sufficiently large and numerous to present a hazard to pedestrian traffic.

It is understood that no structural maintenance and/or repairs have been carried out to any of the structures in the last 14 years. No information is available as to when the cracks and/or settlement of the structures occurred.

It is understood that a 2.08 m. (82 inch) diameter steel penstock runs directly beneath the south-east corner of the Shelter. The penstock, which has an inlet west of the westernmost gate of the Lock, runs parallel to the north

Fenco Engineers Inc.,
September 10th, 1984
Page 10.

side of the Lock, beneath the Shelter and discharges into a surge tank at the west end of the Pumphouse. It is understood that the head in the penstock and surge tank water level are maintained at the same elevation as the water level upstream of the Lock. It is further understood that the penstock was built in conjunction with the construction of the original Lock approximately 100 years ago. The location of this penstock is shown on Drawing T10829-1 located at the rear of this report.

The results of a visual inspection of the inside of the penstock carried out on July 12th, 1984 by Fenco Engineers Inc. and Parks Canada personnel indicated that in general the penstock was in relatively good condition with only 7 joints over the entire ±100 m length inspected exhibiting leakage. All such leaks were minor with respect to the amount of water flow and none indicated any presence of soil suspended in the water. Some water was noted to be leaking from the top of the joints, thereby indicating that the groundwater level in the vicinity of the penstock was at least as high as the top of the penstock. Further details regarding the inspection will be reported separately by Fenco Engineers Inc.

Prior to the construction works carried out in 1981 and 1982 at the Great Lakes Power Limited's power station on the north side of St. Mary's Island, it was suspected that

Fenco Engineers Inc.
September 10th, 1984
Page 11.

groundwater seepage was occurring across St. Mary's Island. Dye was thus introduced into the power canal slightly upstream of the Administration Building and was observed to exit downstream of the eastern lock gate within one to two hours after the introduction of the dye. This distance is some 200 m and thus the rate of groundwater flow was some 0.05 to 0.1 m/sec at that time.

As part of the Great Lakes Power Limited construction carried out in 1981 and 1982 a cut off trench and dyke was constructed across the north part of St. Mary's Island at the location shown on Drawing T10829-1. The cut off trench and dyke possess a core of impervious soil which was founded directly on the sandstone bedrock. The bedrock was grouted to reduce its permeability. At the north end of the cut off trench, a dyke of similar construction was installed from the cut off trench east along the south side of the power canal, abutting at its eastern limit against the concrete powerhouse.

The water level at the west end of the Lock corresponds approximately to Lake Superior water level. Gauge station 10980 located upstream of the Canadian Lock at Sault Ste. Marie indicated an average annual water level at about elevation 183.05 (Geodetic Datum) in 1978 with an extreme range of about 182.3 to 183.5 for that year. The water

Fenco Engineers Inc.
September 10th, 1984
Page 12.

level elevation at the east end of the Lock corresponds to the elevation of the water level in Lake Michigan and Lake Huron downstream of the rapids. Gauge station 11010 located downstream of the Canadian Lock at Sault Ste. Marie indicated an annual average water level at about elevation 176.95 (Geodetic Datum) in 1978 with an extreme range of about 176.5 to 177.3 for that year. Therefore the average water level difference upstream and downstream of the Canadian Lock is about 6.1 m (20 feet).

According to Parks Canada personnel approximately 4000 passages through the Lock occur every shipping season, which lasts slightly in excess of seven months. During the winter months when the Lock is inoperative, the water level in the Lock is maintained at or slightly above the Lake Michigan - Lake Huron level, i.e. about elevation 176.95 m. During this time significant amounts of water seep through the Lock gates and through the Lock wall itself. It is further understood that the water level in the Lock is lowered to the bottom of the lock for routine maintenance for a period of several weeks each year during late November and early December. The floor of the lock is at about elevation 171 m. Dewatering of the Lock is facilitated by culverts located under the floor of the Lock with inverts at elevation 168.2 m.

To develop the pertinent geotechnical information for the site, Great Lakes Power Limited was contacted to obtain

Fenco Engineers Inc.
September 10th, 1984
Page 13.

information regarding the results of water level observations made in various piezometers installed in connection with the construction work carried out in 1981 and 1982. We were provided with the results of observations made in Piezometers 300, 301 and 302 located downstream of the cut-off trench and dyke. The information obtained from Great Lakes Power Limited is included in Appendix III of this report. The plan locations of the piezometers are also shown on Drawing T10829-1 accompanying this report. The results of observations made in lower Piezometer 302 in late November and early December, 1982 indicate the piezometric level was at about elevation 171.5 m for a period of about 2 weeks. This corresponds to the time that the Lock was dewatered for routine annual maintenance. Piezometer installation 302 is located close to the Lock. Upper Piezometer 302 also responded during this time interval with a piezometric level at about elevation 174 to 174.5 m. Piezometers 300 and 301 located further away from the Lock did not appear to respond to dewatering of the Lock in late November and early December, 1982.

Based on the above information on site conditions and background, a number of general observations of a geotechnical nature are made in respect to the significance of this information.

- a) The rate at which dye travelled from the power canal to the lower section of the river downstream of the Lock gives evidence that the flow path

involved is highly pervious. The flow path of the dye must therefore have consisted of coarse materials such as rock fill rather than the natural till and sandstone bedrock common to the area. In this regard the coefficient of permeability of the flow path; based on back calculation from known velocity and gradient, is about 50 to 100 cm/sec. This compares to an approximate estimated coefficient of permeability of about 10^{-4} to 10^{-2} cm/sec for the sandstone bedrock and about 10^{-5} to 10^{-3} cm/sec for the natural till. A permeability of 10^{-2} cm/sec and a hydraulic gradient of about 6 m drop over 200 m length would give a computed travel time of about 230 days in comparison to the observed travel time of 1 to 2 hours. The above is considered to represent positive evidence that the flow path taken by the dye is equivalent to that which would apply to open rock fill without significant infilling in the void spaces.

- b) The observations at Piezometer installation 302 indicate that the groundwater level adjacent to the Lock responds to the annual dewatering operation at the Lock. This dewatering operation involves pumping from culverts below the floor of the Lock to relieve hydrostatic pressure under the Lock structure while the water within the Lock is

removed. This operation would therefore create an annual cycle of groundwater level variation adjacent to the Lock. The extent to which the groundwater level responds to variations of water level within the Lock during operation and to the sustained lower winter level, exclusive of dewatering from the culverts below the Lock, is not known.

- c) Voids have been observed beneath the surface concrete slabs near the Shelter and subsidence of the slab near the Stores Building has occurred. It is not known when these slabs were placed although it was probably in the 1950's based on information provided by Parks Canada. Since the slabs would have been poured directly on grade, it is apparent that the voids developed since construction of the slabs. This would indicate that the subsidence is probably an ongoing process which takes place gradually over the years.

- d) The sink holes observed during spring thaw are considered to be related to loss of soil into voids of coarse rock fill. In this case the soil movement would be mainly in a vertical direction and would be initiated by infiltration and spring groundwater level variations. It is not expected that much lateral migration of soil would occur with groundwater flow, considering the velocity of about 1m/sec referred to in item (a) above.

Groundwater level variations due to dewatering from the culverts below the Lock could also be a factor resulting in downward migration of fines. Also it is possible that gradients resulting from such operations would be sufficiently high to cause lateral migration of fines through open rock fill.

- e) It appears that loss of soil into the 2.08 m diameter penstock is not presently a significant factor in respect to the subsidence which has occurred. This is based on the very limited water seepage observed at pipe joints by Fenco Engineers Inc. during their inspection inside the pipe.

5.0 DISCUSSION

Some structures and pavements on St. Mary's Island in Sault Ste. Marie have experienced settlements and subsidence. Parks Canada have retained Fenco Engineers Inc. to determine the cause of these settlements and to propose appropriate remedial measures for the structures and pavements and means by which to prevent future settlements. The purpose of this investigation was to determine the soil and groundwater conditions near the structures and pavements exhibiting greatest distress, with the objective of determining the mechanism at the seat of the settlements and to offer general comments regarding remedial measures to the structures and pavements.

5.1 Area Near Canalman's Shelter

5.1.1 Cause of Settlements

The results of Borehole 104 put down during this investigation indicated that, at the borehole location, the subsoil conditions beneath a 0.61 m thick layer of surficial sand and gravel fill, comprised a deposit of silty sand and glacial till to a depth of at least 4.89 m. It is pointed out that Borehole 104 was located near the north wall of the Shelter; not near the south wall where the greatest observed subsidence has occurred; hence the conditions near the south wall may differ from those near the north wall. It is considered that the soil beneath the south wall of the Shelter is composed of fill material placed around and over the penstock, which passes beneath the southeast corner of the Shelter.

The observed subsidence of the southeast corner of the Shelter and the sidewalks near the south wall of the Shelter are considered to have been caused by one or a combination of the following mechanisms.

- a) The presence of loose and poorly compacted fill may have caused the settlement. It is considered that if the fill material that is inferred to be

present beneath the south wall of the Shelter was placed in a loose state; then consolidation of the fill mass over the years under imposed loadings and its self weight could have contributed to the voids that were observed under the walkways during recent construction. Since such settlement should have been essentially completed some 5 to 10 years after construction; it is likely that some other factors are operating such as groundwater level variations and vertical migration of fine soil sizes.

- b) If the fill beneath the south wall of the Shelter is composed of blast rock from the canal excavations covered by finer grained fill material; the upper fill could have migrated downwards over the years into the voids of the blast rock. This migration could have been aided by the frequent usages of the Lock; which would result in variation of the groundwater levels near the Shelter; causing a pumping action.
- c) Loss of ground into the penstock beneath the Shelter is not likely a significant factor in this instance. The inspection of the penstock revealed that a very small amount of water was leaking through some of the joints and such seepage would

Fenco Engineers Inc.
September 10th, 1984
Page 19.

not likely carry soil in suspension. It is possible; however, that soil was present in water infiltrating into the penstock in previous years.

- d) It is possible that the settlement is due to structural deterioration of the foundations of the structure.

5.1.2 Remedial Measures

Inasmuch as the subsoil conditions beneath the south wall of the Shelter are unknown, specific remedial measures cannot be formulated at this time. It is essential that these subsoil conditions be determined prior to final selection of remedial measures. Preferably, one or more test pits should be carefully excavated along the south wall of the Shelter so as to determine the en masse soil and groundwater conditions. These test pits should be excavated as deep as practical, but should at least extend to natural ground.

Generally, it is considered that typical remedial measures could consist of:

- a) Underpinning the foundations of the Shelter
- b) Stabilizing the soils beneath the foundations of the Shelter with grout.

5.1.2.1 Underpinning

Underpinning consists of installing piers beneath the existing foundations of a structure so as to transfer the loads generated by the structure through a poor soil deposit (i.e. the soil deposit causing the distress of the structure) to a more competent formation. Typically, short sections of the walls of the structure in question are excavated at several locations (generally no more than one-quarter or one-third of the structure's foundation walls are underpinned at any one time). After excavation down to the desired bearing level has been completed, piers are installed which may comprise cast-in-place or pre-cast concrete piers, short sections of steel tube or steel H piles, or other such foundation units. If conditions are favourable, piles can be driven just outside the existing foundation down to the desired bearing level and tied in structurally to the existing foundation. After one section of the wall of the structure has been completely underpinned, work progresses to an adjacent section of the foundation, and so on until the entire foundation is underpinned. The choice between excavating all the way to a competent bearing stratum or driving piles; and the choice of materials for the underpinning piers; depends upon space restrictions economic considerations and the like which are beyond the scope of this report. It should be noted that heavy groundwater infiltration might be experienced in excavations through coarse fill materials. This should be handled by peripheral ditches leading to sumps equipped with pumps of adequate capacity.

Fenco Engineers Inc.
September 10th, 1984
Page 21.

5.1.2.2 Grouting

Grouting entails the injection of a substance in fluid form into a soil or rock mass which imparts some measure of strength to the mass after the grout has cured or "set up"; as well as reducing the hydraulic conductivity of the grouted formation. The strength is in the form of increased cohesion in the soil or rock mass; generated by the formation of bonds between soil or rock particles by the injected grout. These bonds would minimize the migration of soil particles. Typically, cement is commonly used in grouting operations.

For the area near the Shelter, the viability of grouting depends largely on the subsoil conditions of the area to be grouted. Should blast rock fill with large open voids be present; then the grout, when injected, would tend to disperse through the voids; requiring a large volume of grout to achieve any degree of improvement in the soils' characteristics. If the soil in the area of the Shelter comprises soil of a granular nature which will allow injection of grout to take place without excessive dispersion; then grouting may be an acceptable solution. Clearly, the need to accurately determine the soil conditions beneath the south wall of the Shelter is essential.

5.2 Area Near Stores and Pumphouse Buildings

5.2.1 Cause of Settlements

The results of Boreholes 101 to 103 indicated that beneath the concrete surfacing, a fill deposit was present to depths ranging from 0.61 to 3.20 m. The fill deposit overlies a glacial till deposit which in turn overlies sandstone bedrock which was encountered at depths ranging from 2.59 to 4.88 m. Significantly, an apparent void 0.45 m in vertical dimension was encountered in Borehole 103 at a depth of 2.29 m; near the bottom of the fill deposit. As well, maps of the St. Mary's Island area showing the evolution of its topography over the last 100 years indicate that the east end of the present island defined by the ship canal to the south and the power canal to the north was once a series of small islands. The channels between the islands were reportedly filled with blast rock derived from the canal excavations. Furthermore, a dye test carried out by Great Lakes Power Limited showed that dye introduced in the power canal exited within 1 to 2 hours downstream of the lower canal lock gate, a distance of about 200 m; thereby indicating that there were present buried channels filled with open work material as discussed earlier.

In view of the evidence for the presence of blast rock fill in the vicinity of the Stores and Pumphouse areas, it is

Fenco Engineers Inc.
September 10th, 1984
Page 23.

considered that the most likely cause of settlements of the structures and pavements is the downward migration of fine soil particles into the voids of the blast rock fill. This migration is probably induced by infiltration, groundwater level variations and to some extent by groundwater flow.

5.2.2 Remedial Measures

It is considered that unless the soil beneath the foundations of the structure and the pavements is prevented from migrating down into the voids of the underlying blast rock the subsidence of structures and pavements will likely continue.

As for the area near the Canalman's Shelter the most attractive remedial measures for the Stores Building are underpinning and grouting. Prior to deciding which alternative to pursue, it is recommended that test pits be excavated through the fill deposit at several locations across the affected areas so as to obtain information regarding the en masse subsoil conditions.

Because of the probability of the presence of blast rock fill near the south end of the Stores Building and the relatively shallow depth to bedrock (+2.5 m), it is considered at this time that underpinning will likely be pref-

Fenco Engineers Inc.
September 10th, 1984
Page 24.

erable to grouting. In this regard, it appears that only the section to the south end of the Stores Building would require remedial measures. The large voids in blast rock fill would provide conduits for the rapid dispersion of injected grout from the affected areas, thereby requiring large amounts of grout, and thus significant costs, to complete the grouting operations. Underpinning would be carried out in a manner similar to that described in Section 5.1.2.1.

However, insofar as grouting is concerned, some experience in successfully grouting soils with a similar tendency to disperse grout was recently obtained in Ontario. The particular grouting operation involved the injection of a hot bituminous mass in the area to be grouted immediately prior to the injection of the cementitious grout. The bituminous injection acted as a physical barrier to the dispersion of the cementitious grout while at the same time decreasing the set time from several hours to less than 1 hour due to the heat of the bituminous mixture. It is recommended that grouting specialists be contacted prior to using this or other grouting schemes.

For pavement areas exhibiting distress from subsidences, underpinning is not realistic and grouting a large area may prove prohibitively costly. One solution might be to remove the existing pavement and all fill down to the top of the

Fenco Engineers Inc.
September 10th, 1984
Page 25.

blast rock fill or natural soil. A geotextile fabric could then be placed over the exposed blast rock fill and high quality free draining granular backfill placed and well compacted to restore desired grades. The geotextile would minimize the loss of the new backfill into the voids of the blast rock fill, and would provide some tensile reinforcement as an aid to bridging over voids.

If a concrete surfacing is selected then the slab should possess sufficient reinforcing so as to span minor voids beneath the slab which may develop with time. An asphalt pavement would be more flexible than a concrete one, and would thus exhibit less cracking. As well, asphalt surfacings lend themselves more readily to upgrading and maintenance than do concrete surfacings.

An alternative to use of a geotextile fabric would be to backfill with layers which are filter graded with respect to the rock fill. We would be pleased to provide further details regarding this alternative as your planning becomes more advanced, if required.

6.0' CLOSURE

We trust that this report which was reviewed by Mr. H.L. MacPhie, P.Eng., is sufficient for your present purposes.

FencoEngineers Inc.;
September 10th, 1984
Page 26

We look forward to being of further assistance to you on this interesting project. In the meantime, please do not hesitate to contact us if you have any questions.

Yours very truly,
GEOCON INC.



B. Cooke, P.Eng.
Senior Project Engineer

BC:bg
T10829/42313

APPENDIX I

Boring Logs

EXPLANATION OF THE FORM BORING LOG

This form summarizes both field information and selected laboratory test results obtained from each boring. An explanation of the various columns of the form follows.

DEPTH

This column gives the depth scale of the boring.

ELEVATION AND DEPTH

This column gives the elevation and depth of inferred geologic contacts. The elevation is referred to the datum shown in the general heading.

DESCRIPTION

This column gives a description of the soil based on visual examination of the samples and laboratory tests. Each stratum is described according to the following classification and terminology:

<u>Classification*</u>	<u>Particle Size</u>	<u>Particle Size or Sieve No. (U.S. Standard)</u>
Clay	less than 0.002 mm	less than 0.002 mm
Silt	from 0.002 to 0.075 mm	from 0.002 mm to #200 sieve
Sand	from 0.075 to 4.75 mm	from #200 sieve to #4 sieve
Gravel	from 4.75 mm to 75 mm	from #4 sieve to 3 in.
Cobbles	from 75 to 200 mm	from 3 in. to 8 in.
Boulders	larger than 200 mm	over 8 in.

<u>Terminology</u>	<u>Proportion</u>
Trace, or occasional	Less than 10%
Some	10 to 20%
Adjective (e.g. silty or sandy)	20 to 35%
And (e.g. sand and gravel)	35 to 50%

*Unified Soil Classification System (ASTM D2487-75).

The relative density of cohesionless soils and the consistency of cohesive soils are defined by the following:

<u>Relative Density</u>	<u>Penetration Resistance "N" Blows/0.3 m or Blows/foot</u>	<u>Consistency</u>	<u>Undrained Shear Strength**</u>	
			<u>kPa</u>	<u>psf</u>
Very loose	0 to 4	Very soft	0 to 12	0 to 250
Loose	4 to 10	Soft	12 to 25	250 to 500
Compact	10 to 30	Firm	25 to 50	500 to 1000
Dense	30 to 50	Stiff	50 to 100	1000 to 2000
Very dense	over 50	Very stiff	100 to 200	2000 to 4000
		Hard	over 200	over 4000

** The compressive strength obtained from the quick (Q) triaxial test is equal to twice the shear strength of the clay.

SYMBOL

These standard symbols describe the stratigraphy of the soil and rock strata.

(Continued on reverse)

WATER LEVEL

This column shows the groundwater level in the boring measured on the date indicated. In impervious soils the accurate determination of ground water elevations by standpipe, casing or open-hole readings is not possible within the normal time frame of the completion of the site work, and the true groundwater level may be higher or lower than indicated. Where both pervious and impervious soil strata are penetrated, the groundwater levels in each layer may be at different levels and sealed piezometers or standpipes within the individual layers are required to establish true groundwater conditions. Water levels determined by a piezometer can be considered as reliable groundwater levels for the layer in which the piezometer tip is located.

TESTS

The central section of the log forms a graph which is used to plot selected field and laboratory test results, at the elevation at which they were carried out. The symbols and scales for the plotting are shown at the head of the column. The dynamic penetration test blows are the number of blows required to drive a 51 mm (2 in.) diameter cone a depth of 0.3 m (1 foot) using an energy of 480 joules (4200 lb.-in.). This test is carried out from the ground surface or beyond the cased depth of the borehole.

OTHER TESTS

This column shows the results or abbreviations of other field or laboratory tests which have been performed. An explanation of the abbreviations is given on the top of the form. The results of other tests not plotted on the form are given in an Appendix to the report.

SAMPLES

The first three columns describe the condition, type and number, as well as the percentage recovery, of each sample obtained from the boring. The location and condition of each sample is plotted to scale. The legend for sample condition is explained on the top left side of the form.

The last column shows the "N" value of the soil as determined by the Standard Penetration Test. The "N" value corresponds to the number of blows required to drive the last 0.3 m (1 foot) of a 51 mm (2 in.) diameter standard split spoon sampler with an energy of 480 joules (4200 lb.-in.). The Standard Penetration Test is carried out according to ASTM D1586-74.

Soil and rock samples will be stored for a one year period after which they will be discarded unless we are otherwise instructed.

EXPLANATION OF THE TERM

ROCK QUALITY DESIGNATION (RQD)

The description of bedrock quality for engineering purposes can be inferred from a modified core recovery logging procedure designated as RQD, developed by D.U. Deere.* This classification is based on a modified diamond drill core recovery percentage in which only the pieces of sound core over 4 inches (10 cm) long are counted as recovery. The core must be carefully examined to discount fresh irregular breaks caused by the drilling process (fresh broken pieces are fitted together and counted as one piece). The remaining fragments less than 4 inches (10 cm) length are considered to be due to very close bedding, jointing, fracturing, shearing, or weathering in the rock mass and are not counted. The procedure penalizes the rock where recovery is poor. This is appropriate because poor core recovery usually depicts poor quality rock. In the case of certain shaley sedimentary or thinly foliated metamorphic rocks, the method is not as exact as for other rock types and rock quality requires interpretation by a specialist for the particular engineering application. To minimize the occurrence of core breaks from drilling procedures RQD logging is normally run on core obtained by double or triple tube core barrels and generally of "N" size or greater.

The table below may be used as a general indicator to correlate (RQD) and rock mass quality.

RQD	DESCRIPTION OF ROCK QUALITY
90 - 100	Excellent - intact, very sound, massive
75 - 90	Good - moderately jointed or sound
50 - 75	Fair - blocky and seamy, fractured
25 - 50	Poor - shattered and very seamy or blocky, severely fractured
0 - 25	Very poor - crushed, very severely fractured

*See, for instance:

K.G. Stagg and O.C. Zienkiewicz, "Rock Mechanics in Engineering Practice". New York, Wiley, 1968, Chapter I.

GEOCON



Geocon

BORING LOG

PROJECT Fenco Engineers Inc. BORING 101
St. Mary's Island PAGE 1 OF 1
 CONTRACT NO. T10829/42313 BORING DATE 17.07.84
 DATUM Geodetic CASING CFA

SAMPLE CONDITION		SAMPLE TYPES		ABBREVIATIONS			
	DISTURBED	SS	SPLIT SPOON	GS	GRAIN SIZE ANALYSIS	K	PERMEABILITY (cm)
	GOOD (0.5)	ST	THIN WALLED OPEN (SHELBY)	γ	WET UNIT WEIGHT (kN/m ³)	DS	DIRECT SHEAR
		PS	PISTON SAMPLER	C	CONSOLIDATION	Q	TRIAL CHUCK
		WS	WASH SAMPLE				
		RC	ROCK CORE				

STRATIGRAPHY			TESTS				SAMPLES					
DEPTH - m	ELEVATION - F. DEPTH - m	DESCRIPTION	SYMBOL	WATER LEVEL	UNDRAINED SHEAR STRENGTH - kPa		OTHER TESTS	CONDITION	TYPE	NUMBER	RECOVERY %	STANDARD PENETRATION - N BLOW/30 cm
					Q TEST	FIELD VANE						
					<input type="checkbox"/> INTACT <input type="checkbox"/> REMOULDED	<input type="checkbox"/> INTACT <input type="checkbox"/> REMOULDED						
					<input type="checkbox"/> WATER CONTENT - W% DYNAMIC PENETRATION TEST - BLOW/30 cm 2-5-5	<input type="checkbox"/> LIQUID LIMIT - W% 20 40 60						
					<input type="checkbox"/> PLASTIC LIMIT - W% 20 40 60							

DEPTH - m	ELEVATION - F. DEPTH - m	DESCRIPTION	SYMBOL	WATER LEVEL	OTHER TESTS	CONDITION	TYPE	NUMBER	RECOVERY %	STANDARD PENETRATION - N BLOW/30 cm
0	179.39	Ground Surface								
0	178.83	Concrete								
0.78	178.46	Black organics mixed with sand and gravel						61	31	23
1	178.81	Compact to dense silty sand and gravel till						2	4	34
2	176.80	Sandstone bedrock						3	42	23
3	175.29	END OF BOREHOLE						4	100	79/0.28
4	175.29	END OF BOREHOLE						5	79	27



Geocon

BORING LOG

PROJECT Fenco Engineers Inc. BORING 102
St. Mary's Island PAGE 1 OF 1
 CONTRACT NO. T10829/42313 BORING DATE 17.07.84
 DATUM Geodetic CASING CEA

SAMPLE CONDITION		SAMPLE TYPES		ABBREVIATIONS	
	DISTURBED	SS - SPLIT SPOON		GS - GRAIN SIZE ANALYSIS	P - PERMEABILITY
	GOOD	ST - THIN WALLED OPEN (SHELB)		Y - WET UNIT WEIGHT - kN/m ³	DS - DIRECT SHEAR
	LOST	PS - PISTON SAMPLER		C - CONSOLIDATION	G - TRIAXIAL QUACE
		WS - WASH SAMPLE			
		RC - ROCK CORE			

STRATIGRAPHY			TESTS			SAMPLES				
DEPTH - ELEVATION DEPTH	DESCRIPTION	SYMBOL	UNDRAINED SHEAR STRENGTH - kPa			OTHER TESTS	CONDITION	TYPE	RECOVERY	STANDARD PENETRATION - N BLOW/30 CM
			Q TEST	FIELD VANE	FALL CONE					
			●	◆ INTACT ◆ REMOULDED	▽ INTACT ▽ REMOULDED					
			⊙ WATER CONTENT - W% DYNAMIC PENETRATION TEST - BLOW/30 CM = 1-1-1	□ LIQUID LIMIT - W% 20 40 60 80	△ PLASTIC LIMIT - W% 20 40 60 80					
179.34	Ground Surface									
0.00	Concrete									
178.83	Organics mixed with sand and gravel									
178.53	Dense to very dense pink silty sand and gravel till									
176.55	Sandstone bedrock									
175.02	END OF BOREHOLE									

WATER LEVEL IN OPEN HOLE @ 1.081M DEPTH ON 15-07-84

APPENDIX II

Topographic Maps of St. Mary's
Island from 1888 to 1946

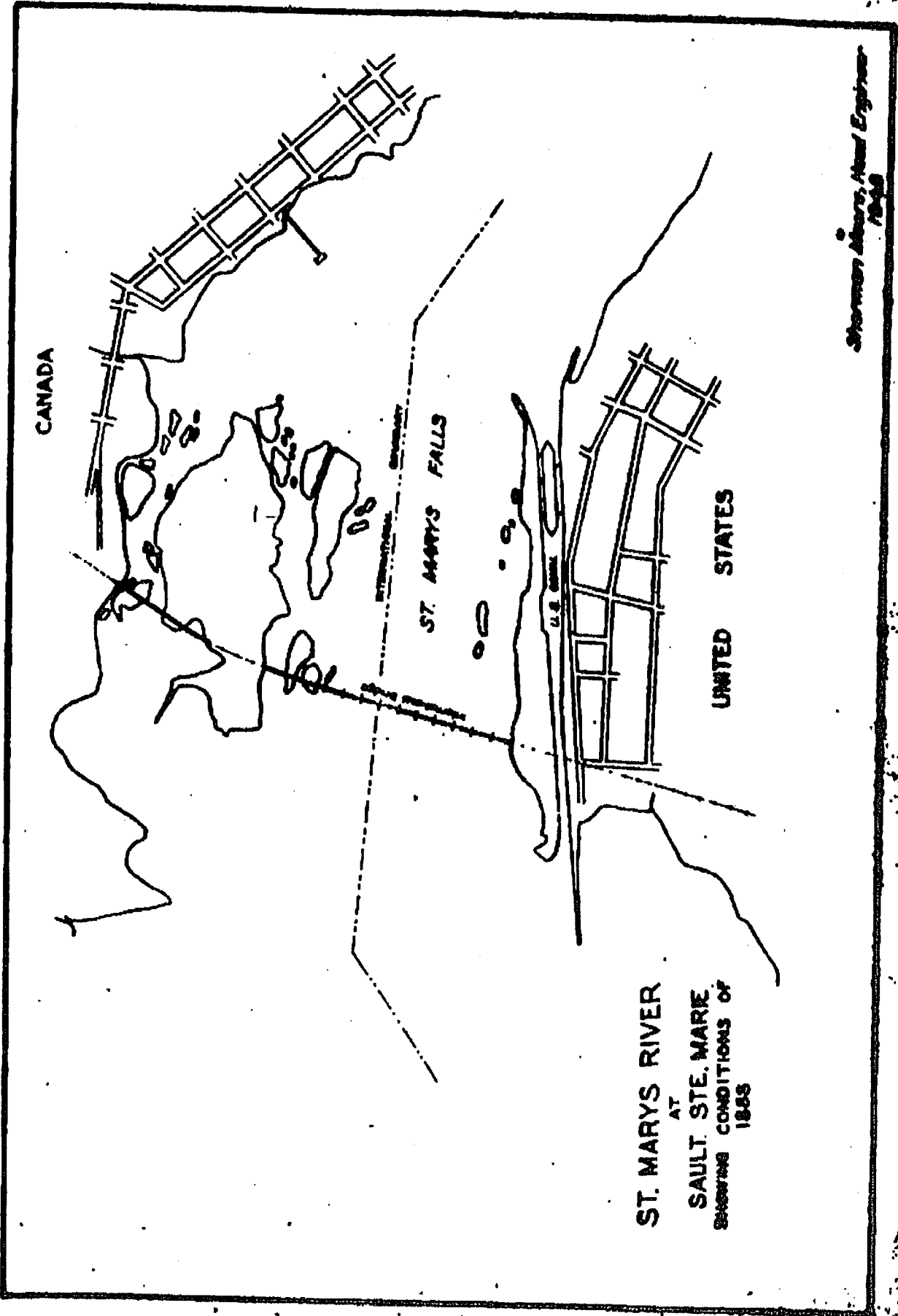

CANADA

ST. MARYS RIVER

INTERNATIONAL BOUNDARY

ST. MARYS RIVER
AT
SAULT STE. MARIE
SHOWING CONDITIONS OF
1888

UNITED STATES

U.S. DAM

Shomon & Sons, Head Engineer
1918

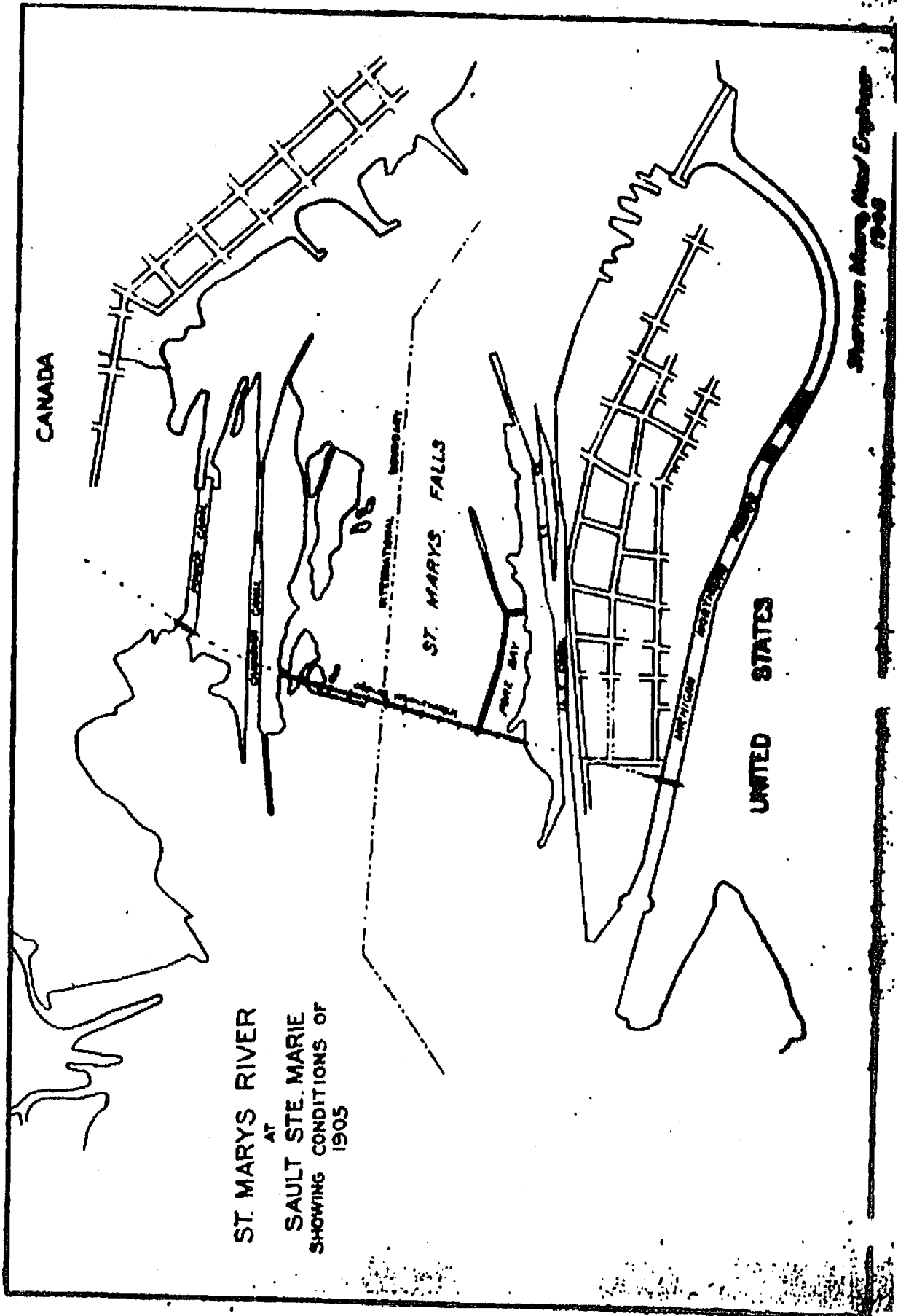

ST. MARYS RIVER
AT
SAULT STE. MARIE
SHOWING CONDITIONS OF
1905

CANADA

ST. MARYS FALLS

UNITED STATES

Shawmut Mining and Eng'g Co.
1906

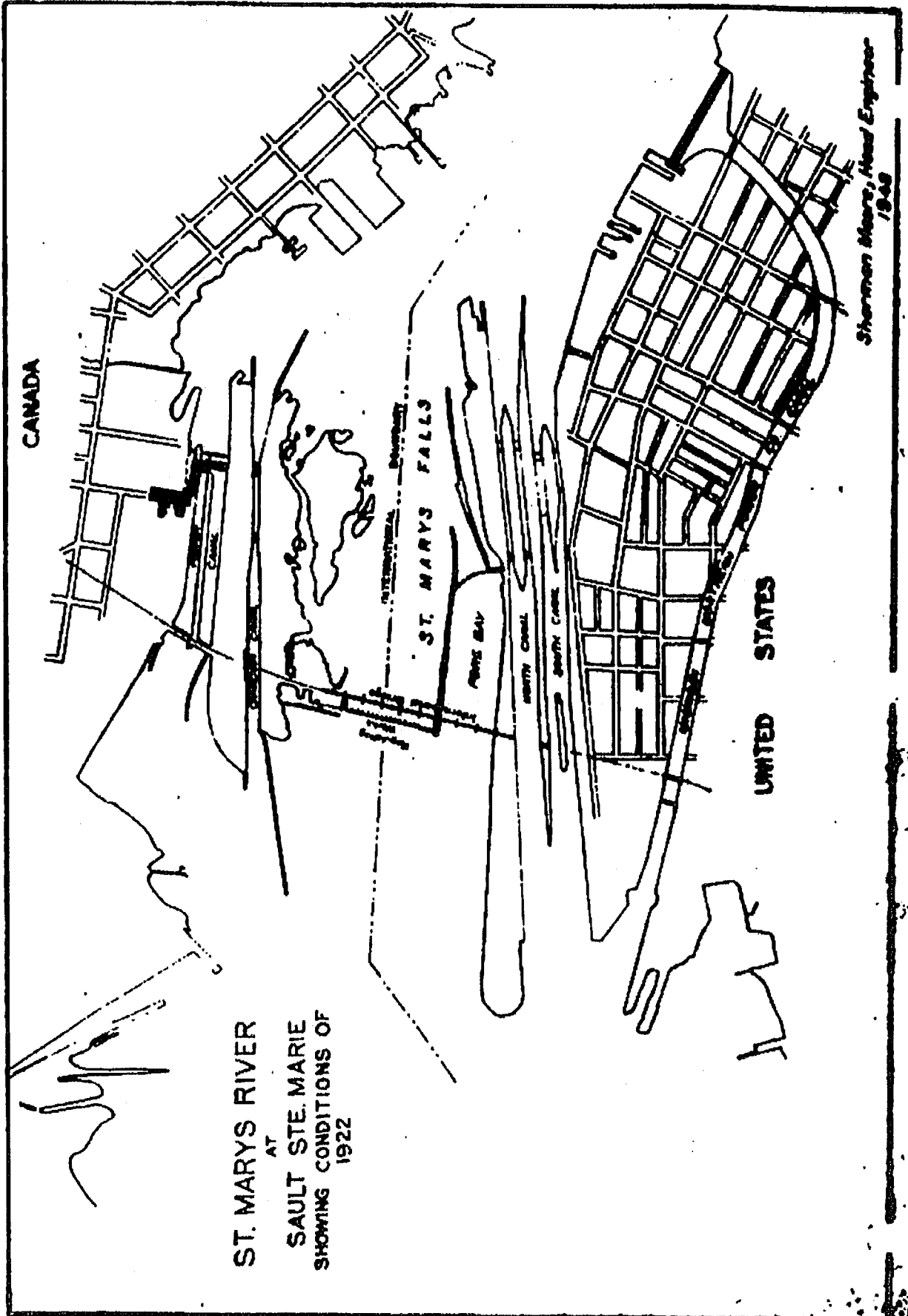

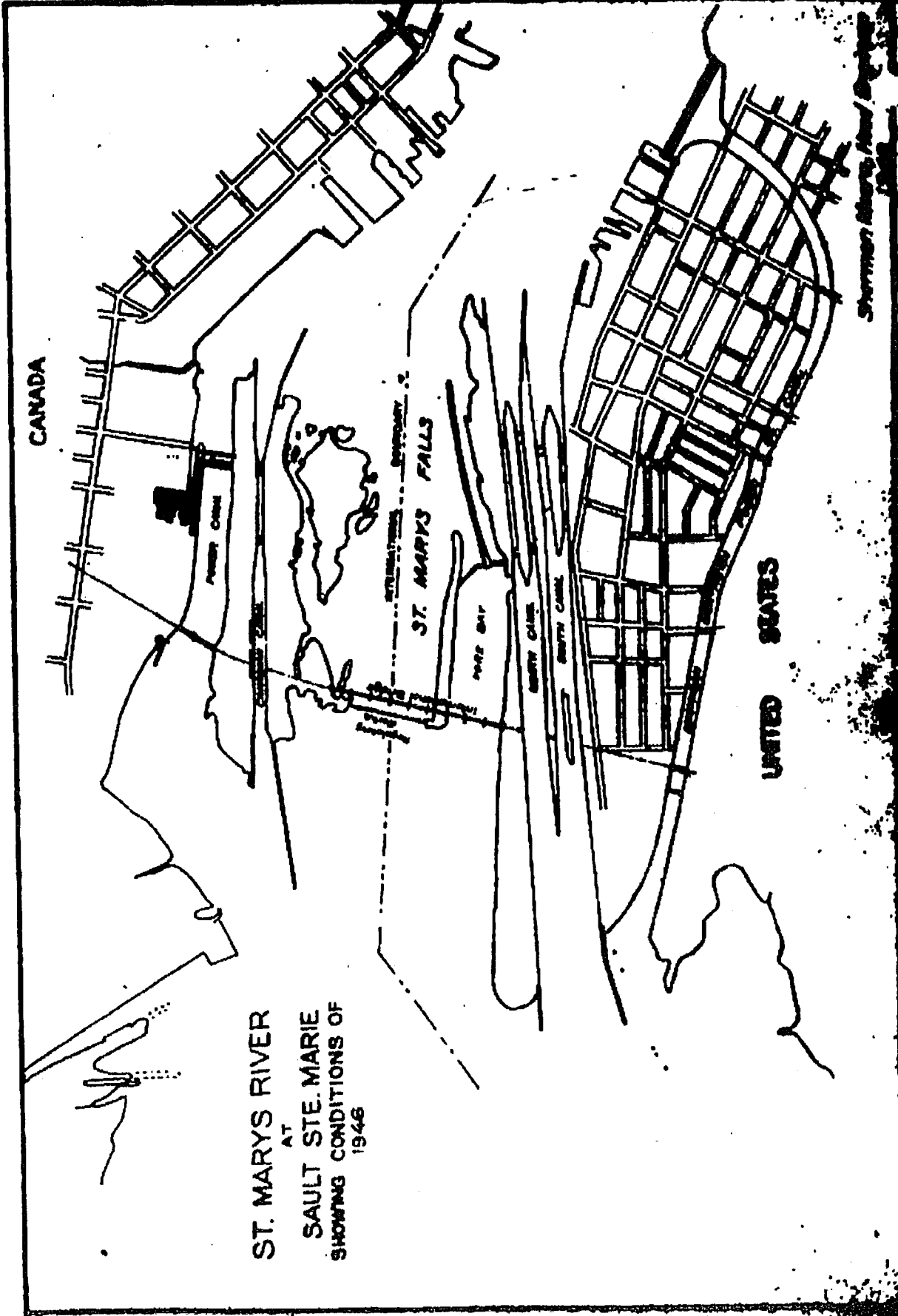

APPENDIX III

Piezometric Observations in
Great Lakes Power Limited
Piezometers for 1982-198

GREAT LAKES POWER LIMITED

P.O. Box 100
SAULT STE. MARIE, ONTARIO
P8A 9L4

AREA CODE 705
949-1378

August 09th 1984

RECEIVED
AUG 14 1984
GEOCON INC.

Mr. Barry Cooke,
Géocon,
3210 American Drive,
MISSISSAUGI, Ontario.
L4V 1B3

Dear Mr. Cooke:

I refer to your recent telephone call and enclose herewith a copy of our records for piezometric elevations at the three stations located in the seepage cut-off on St. Mary's Island.

Yours truly,



Doug J. Symington, P. Eng.
Sr. Civil Engineer

DJS/DCF

Encl.

ST. MARY'S ISLAND

PIEZOMETER READINGS - SUMMARY SHEET - SEEPAGE CUT-OFF

DATE OF MEASUREMENT	RESERVOIR ELEVATION	PIEZOMETRIC ELEVATION				UPPER LOWER
		P300	P301	P302		
SEPT. 24/82	/	180.22	180.63	180.22		UPPER LOWER
SEPT. 27/82	/	177.86	176.51	179.37		UPPER LOWER
SEPT. 28/82	/	180.08	180.78	179.57		UPPER LOWER
SEPT. 28/82 AM.	/	178.20	180.78	178.21		UPPER LOWER
SEPT. 28/82 AM.	/	180.19	180.76	180.51		UPPER LOWER
SEPT. 28/82 PM.	/	177.91	180.76	179.60		UPPER LOWER
SEPT. 28/82 PM.	/	180.14	180.78	179.67		UPPER LOWER
SEPT. 29/82 AM.	/	177.99	180.78	177.03		UPPER LOWER
SEPT. 29/82 AM.	/	180.14	180.81	180.41		UPPER LOWER
SEPT. 29/82 PM.	/	177.86	180.81	179.60		UPPER LOWER
SEPT. 29/82 PM.	/	180.14	180.78	180.36		UPPER LOWER
SEPT. 29/82 PM.	/	177.86	180.78	179.57		UPPER LOWER
OCT. 1/82 AM.	/	180.09	180.81	179.90		UPPER LOWER
OCT. 1/82 PM.	/	178.21	180.81	179.06		UPPER LOWER
OCT. 1/82 PM.	/	180.14	183.65	180.46		UPPER LOWER
OCT. 2/82 AM.	/	178.26	180.76	178.96		UPPER LOWER
OCT. 2/82 AM.	/	180.14	183.61	180.63		UPPER LOWER
OCT. 2/82 AM.	/	178.28	180.81	179.27		UPPER LOWER
OCT. 3/82 AM.	/	180.30	183.27	180.49		UPPER LOWER
OCT. 3/82 AM.	/	177.80	180.71	179.77		UPPER LOWER
OCT. 3/82 PM.	/	176.99	183.35	-		UPPER LOWER
OCT. 4/82 AM.	/	179.74	183.32	180.38		UPPER LOWER
OCT. 4/82 AM.	/	178.62	180.76	179.82		UPPER LOWER
OCT. 5/82 AM.	178.678	179.96	183.27	179.44		UPPER LOWER
OCT. 5/82 AM.	178.24	177.86	180.76	179.44		UPPER LOWER



GREAT LAKES POWER CORPORATION LIMITED
 UTILITIES DIVISION
 ST. MARY'S REDEVELOPMENT PROJECT

PIEZOMETER READINGS
 SEEPAGE CUT-OFF

DATE SEPT. 1982

DEPARTMENT

SCALE NONE

PROJECT R.W. Williams

CA-72715

ACRES

DRAWING No.

FORM 5-2

SHEET

REV.

▲

**ST. MARY'S ISLAND
PIEZOMETER READINGS - SUMMARY SHEET - SEEPAGE CUT-OFF**

DATE OF MEASUREMENT		RESERVOIR ELEVATION	PIEZOMETRIC ELEVATION				UPPER LOWER
			P300	P301	P302		
Oct. 5/82	PM.	178.678	180.42 178.87	183.25 180.76	181.35 181.35		UPPER LOWER
Oct. 6/82	AM.	179.838	180.04 178.67	183.12 180.76	181.58 181.65		UPPER LOWER
Oct. 6/82	PM.	179.978	179.99 178.67	183.04 180.76	181.58 181.68		UPPER LOWER
Oct. 7/82	AM.	180.078	179.94 178.70	183.12 180.76	181.54 181.64		UPPER LOWER
Oct. 7/82	PM.	179.813	180.01 179.03	183.12 180.76	181.39 181.11		UPPER LOWER
Oct. 8/82	AM.	180.248	180.19 179.36	183.04 180.76	180.94 180.87		UPPER LOWER
Oct. 8/82	PM.		180.27 179.25	181.22 180.76	180.33 180.69		UPPER LOWER
Oct. 9/82			179.18 179.08	181.22 180.76	180.31 179.47		UPPER LOWER
Oct. 10/82		180.198	180.27 179.36	181.22 180.76	181.20 181.04		UPPER LOWER
Oct. 11/82			180.19 179.28	181.22 180.76	180.81 180.59		UPPER LOWER
Oct. 12/82	AM.	180.538	180.27 179.43	181.22 180.76	181.27 181.12		UPPER LOWER
Oct. 13/82	AM.	180.598	180.27 179.48	181.22 180.76	181.12 181.12		UPPER LOWER
Oct. 18/82			180.22 179.74	181.22 180.83	180.94 180.98		UPPER LOWER



GREAT LAKES POWER CORPORATION LIMITED
UTILITIES DIVISION

ST. MARY'S REDEVELOPMENT PROJECT

PIEZOMETER READINGS
SEEPAGE CUT-OFF

ST. MARY'S ISLAND

PIEZOMETER READINGS - SUMMARY SHEET - SEEPAGE CUT-OFF

DATE OF MEASUREMENT	RESERVOIR ELEVATION	PIEZOMETRIC ELEVATION				UPPER LOWER
		P300	P301	P302		
OCT. 19/82	182.008	180.17 179.71	181.19 180.83	180.81 180.81		UPPER LOWER
OCT. 20/82	182.168	180.40 179.61	181.19 180.86	180.94 179.19		UPPER LOWER
OCT. 21/82	182.328	180.47 179.89	181.19 180.86	183.65 181.02		UPPER LOWER
OCT. 22/82	182.328	180.47 180.55	181.29 180.89	181.35 181.37		UPPER LOWER
OCT. 25/82	182.328	180.07 179.51	181.19 181.19	179.34 178.15		UPPER LOWER
OCT. 26/82	182.328	180.40 179.37	181.13 180.30	179.92 179.37		UPPER LOWER
OCT. 27/82	182.328	180.15 180.10	180.77 180.55	181.30 181.55		UPPER LOWER
OCT. 28/82	182.328	180.45 176.24	181.16 180.26	181.80 181.98		UPPER LOWER
Nov. 3/82	182.328	180.45 180.30	181.16 180.94	181.65 181.80		UPPER LOWER
Nov. 11/82	182.328	180.50 180.07	180.24 180.37	180.87 180.94		UPPER LOWER
Nov. 15/82	182.328	180.37 179.69	180.94 178.82	179.62 177.74		UPPER LOWER
Nov. 29/82	182.328	180.17 178.57	182.33 180.89	173.98 171.70		UPPER LOWER
Nov. 30/82	182.328	180.28 178.75	182.38 180.89	174.03 171.59		UPPER LOWER

GREAT LAKES POWER CORPORATION LIMITED
 UTILITIES DIVISION
 ST. MARY'S REDEVELOPMENT PROJECT

DATE: SEPT. 1982
 DEPARTMENT: *DB*
 PROJECT: *01.01*

PIEZOMETER READINGS
SEEPAGE CUT-OFF

CA-72715 DRAWING No. FORM S-2

REV. *^*

ST. MARY'S ISLAND PIEZOMETER READINGS - SUMMARY SHEET - SEEPAGE CUT-OFF

DATE OF MEASUREMENT	RESERVOIR ELEVATION	PIEZOMETRIC ELEVATION				UPPER LOWER
		P 300	P 301	P 302		
DEC. 1/82	182.328	180.42 178.97 177.27	182.21 180.94	174.16 171.59		UPPER LOWER
DEC. 2/82	182.328	180.35 178.97 177.20	181.88 180.89	174.16 171.57		UPPER LOWER
DEC. 3/82	182.328	180.35 179.08 177.32	182.21 180.91	174.21 171.59		UPPER LOWER
DEC. 4/82	182.328	180.35 179.13 177.32	182.13 180.94	174.29 171.64		UPPER LOWER
DEC. 5/82	182.328	180.32 179.13 177.30	182.10 181.22	174.39 171.59		UPPER LOWER
DEC. 10/82	182.328	180.35 179.20 177.55	181.93 180.94	174.34 171.59		UPPER LOWER
APR. 11/83	182.265	179.69 179.69 179.69	182.74 180.91	181.80 182.11		UPPER LOWER
MAY 4/83	182.70	179.54 179.54 179.54	182.13 180.91	181.81 182.10		UPPER LOWER
MAY 31/83	182.600	179.99 179.53 178.97	181.82 180.91	181.80 180.59		UPPER LOWER
JUL 14/83	182.655	179.69 179.69 179.38	181.22 180.91	181.60 181.60 181.00		UPPER LOWER
OCT. 29/83	183.02	181.54 181.58		UPPER LOWER
Nov. 2/83	...	179.75 179.82 179.53		UPPER LOWER
Nov. 4/83	182.89 180.96	...		UPPER LOWER

ACRES
 GREAT LAKES POWER CORPORATION LIMITED
 UTILITIES DIVISION
 ST. MARY'S REDEVELOPMENT PROJECT

DATE: SEPT. 1982
 SCALE: NONE
 DEPARTMENT: *WWT*
 PROJECT: *R.A. Johnson*

**PIEZOMETER READINGS
SEEPAGE CUT-OFF**

CA-72715
 ACRES

DRAWING No. FORM S-2
 SHEET 4

REV. *^*

ST. MARY'S ISLAND
SEE PAGE CUT-OFF

PIEZOMETER READINGS - SUMMARY SHEET - SEE PAGE CUT-OFF

DATE OF MEASUREMENT		RESERVOIR ELEVATION	P300	CSHAYER PITE	P301	P302	PIEZOMETRIC ELEVATION		
APR. 25/84	182.3	179.59	179.39	182.25	178.80		UPPER		UPPER
		179.34		180.86	178.25		LOWER		LOWER
							UPPER		UPPER
							LOWER		LOWER
							UPPER		UPPER
							LOWER		LOWER
							UPPER		UPPER
							LOWER		LOWER
							UPPER		UPPER
							LOWER		LOWER
							UPPER		UPPER
							LOWER		LOWER
							UPPER		UPPER
							LOWER		LOWER
							UPPER		UPPER
							LOWER		LOWER
							UPPER		UPPER
							LOWER		LOWER

 GREAT LAKES POWER CORPORATION LIMITED
 UTILITIES DIVISION
 ST. MARY'S REDEVELOPMENT PROJECT
 DATE SEPT. 1982 DEPARTMENT *DES*
 SCALE NONE PROJECT *R.W. DeWitt*

PIEZOMETER READINGS
 SEEPAGE CUT-OFF
 CA-72714 ACRES DRAWING No. FORM S-2 REV.
 SHEET *1*



N 16° 30' 42" 671
 E 911 657 982
 N 5° 15' 29" 295
 E 277 873 355

APPROX EXISTING
 W.L. EL. 601.0 (192.16)

SOUTH DIKE

N 85° 16' 46" W BOUNDARY

SCOUT
 CURTAIN

602
 603
 604
 605

GRAVEL
 PARKING
 AREA

1/2 WATER LINE

9.300W-TRUCK
 9.300W-TRUCK

LAWN

CINDER
 SILO

604
 603

N 85° 36' 47" E

N 16° 30' 50"

BELL TELEPHONE
 ANCHOR

B ↑

FENCE

POWER LINE

7' PENSTOCK

602
 603
 604

GSC
 BENCHMARK NO 1027

PARKS
 CANADA

679
 (2070)

P5010

MH

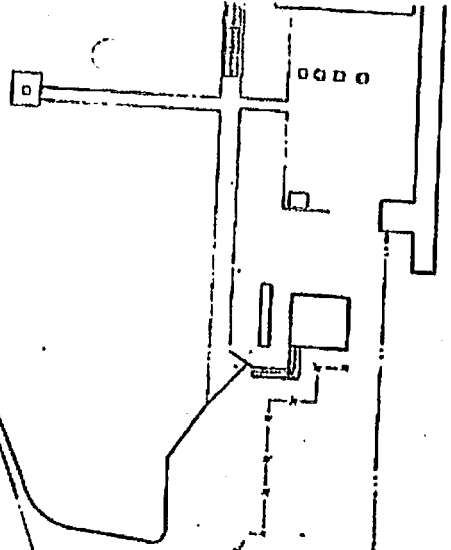

HEAD OFFICE
FILE COPY

T10829-2

REPORT TO

FENCO ENGINEERS INC.
SAULT STE. MARIE ONTARIO

ADDITIONAL GEOTECHNICAL INVESTIGATION
GROUND SUBSIDENCE
PARKS CANADA
ST. MARY'S ISLAND
SAULT STE. MARIE ONTARIO

Distribution:

4 copies - Fenco Engineers Inc.

2 copies - Geocon Inc.

November, 1985



Geocon

November 20, 1985

Fenco Engineers Inc.
421 Bay Street
Station Tower
Sault Ste. Marie, Ontario
P6A 1X3

Attention: Mr. D.B. Bazely, P.Eng.

RE: ADDITIONAL GEOTECHNICAL INVESTIGATION
GROUND SUBSIDENCE
PARKS CANADA
ST. MARY'S ISLAND
SAULT STE. MARIE, ONTARIO

Gentlemen:

This letter reports the results of the additional geotechnical investigation carried out for the above noted project. This work was carried out as per the telephone conversations held between your Mr. D.B. Bazely and our Mr. B. Cooke.

The purpose of this investigation was primarily to supplement the information regarding the subsurface soil conditions at the site that was obtained during our initial geotechnical investigation reported to you in Report T10829, dated September 10, 1984. In this regard, this report should be read in conjunction with our previous report.

Specifically, this investigation was to attempt to ascertain if fill soils containing large voids were present beneath structures on St. Mary's Island which have experienced cracking of walls and window sills due to ground subsidence at these locations.

Lavalin

The secondary purpose of this investigation was to attempt to evaluate the "groutability" of the fill soils beneath the structures in question, should grouting be determined to be a viable remedial measure. To this end, the soil conditions in the test pit excavations were examined by Mr. Martin Jones of Cementation Company, a firm specializing in grouting.

1.0 BACKGROUND INFORMATION

Various structures at St. Mary's Island have experienced differential settlements over an indeterminate period of time. Specifically, the south west corner of the Canalman's Shelter, the southeast corner of the Stores Building, the concrete pavement outside the Stores Building and the Pump-house as well as the asphalt pavement adjacent to the north wall of the shipping canal all exhibit indications of movement. It has been hypothesized that one cause of these movements was subsidence of the ground supporting these structures.

In Geocon Report T10829 it was established that there was a good possibility that the cause of ground subsidence at the site was the downward migration of fine grained fill material into voids between large pieces of blast rock fill. This blast rock fill would have been dumped into channels between small islands existing at the time of the construction of the canal, or alternatively may have been used as backfill for various structures constructed at the same time as the canal.

The presence of open work material such as blast rock fill at the site was confirmed somewhat by the results of a dye migration test carried out prior to Great Lake Power's construction of an impervious dyke extending from the north wall of the shipping canal to the power canal, along the south dyke

of the power canal to the power dam. This dye test, which consisted of introducing dye into the headrace of the power canal north of the Administration Building, and timing its exit downstream of the lower shipping canal lock, indicated that the permeability of the ground was of the order of 50 to 100 cm/sec, indicative of very coarse grained material.

Furthermore, in Borehole 103 put down during the initial geotechnical investigation, a void 0.45 m in vertical dimension was observed in the fill deposit.

2.0 CURRENT FIELD INVESTIGATION

The field work for this phase of the investigation consisted of the excavation of two test pits on November 5 and 6, 1985. One test pit, TP1, was located to the east of the Canalman's Shelter. The originally planned location for this test pit was just outside the south west corner of the Shelter (the location exhibiting the greatest distress), however, due to interference from shrubbery, it was decided to relocate the test pit to the east of the Shelter. The second test pit, TP2, was located south east of the Stores Building. The location of the test pits is shown on Drawing T10829-1, Revision 1, located at the rear of this report. On this drawing is also shown the soil stratigraphy near the two test pits which was developed incorporating the results of the two test pits as well as the boreholes put down during the first phase of this study. Detailed records of the test pits were prepared, and may be seen on the Test Pit Logs in Appendix I of this report.

3.0 SUBSURFACE CONDITIONS OBSERVED IN TEST PITS

3.1 Test Pit 1 - Canalman's Shelter

Beneath a surficial 0.30 m thick topsoil layer, a random fill deposit comprising cobbles, boulders, debris, etc. in a sand and silt matrix was encountered to a depth of about 1.05 m. This in turn was underlain by a reddish brown till fill deposit, composed of silty sand and gravel with occasional cobbles and boulders. Test Pit TP1 was terminated in this fill deposit at a depth of 3.51m.

It is pointed out that no voids were observed in the fill deposits.

The test pit did not encounter any groundwater throughout its entire depth.

3.2 Test Pit 2 - Stores Building

Beneath a surficial 0.10 m concrete pavement a fill deposit comprising organic silts, sands and gravel was encountered to a depth of 0.30 m. It is possible that this deposit is an old imported topsoil layer.

Beneath the organic silts, sands and gravel layer a random fill deposit was encountered to a depth of 0.76 m. This deposit was observed to comprise cobbles, boulders and debris in a reddish brown silt and sand matrix.

Underlying the random fill deposit a reddish brown till fill deposit was encountered. This deposit, which continued to a depth of 1.83 m, comprised silty sand and gravel with occasional cobbles and boulders.

Beneath the till fill deposit at a depth of 1.83 m a stratum of pink glacial till was encountered. This formation was observed to comprise silty sand and gravel with occasional cobbles and boulders. Test Pit 2 was terminated in this stratum at a depth of 2.50 m.

It is pointed out that no voids were observed in the test pit.

Groundwater was encountered at a depth of 0.90 m, within the till fill deposit. Moderately heavy water flow was observed, sufficient to wash fine soil particles from the fill into the bottom of the test pit. }

4.0 DISCUSSION

4.1 Presence of Open Work Material

In the first phase of this study, it was hypothesized that a possible cause of the ground subsidence at the site was the loss of fine grained soils downwards into voids in coarse fill. The current investigation did not encounter any voids in the fill deposits, nor did the test pits encounter zones of blast rock fill. However, boulder sizes were encountered in the fill zones, which could permit the existence of voids beneath two or more adjacent boulders.

It should be noted that the test pits were not excavated adjacent to the walls of the structures exhibiting the greatest distress. Hence, the soil conditions directly beneath the walls of the structures could differ from those observed in the test pits. Conceivably, far more deleterious conditions could exist beneath the walls.

4.2 Grouting Considerations

As was discussed in our report on the first phase of this study, a possible remedial measure that was considered to halt further ground subsidence was the injection of grout into the fill deposits. The presence of open work material such as blast rock fill would allow the injected grout to disperse laterally quickly, thereby necessitating large quantities of grout or special grouting procedures.

The test pits did not reveal any such open work fill materials. The opinion of Mr. Martin Jones of Cementation Company, a firm specializing in grouting, was that the fill soils exposed by the test pits would not be prone to the rapid dispersion of grout, and that special grouting procedures would not be required. It is pointed out again, however, that the soil conditions directly beneath the portions of the structures exhibiting distress may differ from those observed in the test pits.

4.3 General Comments

Test Pit 1, excavated east of the Canalman's Shelter, did not encounter groundwater throughout its entire 3.5 m depth, even though the shipping canal was full (at Lake Superior level) at the time of observations. It is considered that the backfill around the penstock, which is located between Test Pit 1 and the shipping canal, could be controlling the groundwater condition in the vicinity of the Canalman's Shelter. Examination of Section B-B on Drawing T10829-1, Revision 1, indicates that the penstock invert is some 3 m below the level of Lake Superior (183.05) and slightly below the bottom of Test Pit 1 (elevation 180.84).

The penstock feeds into a surge tank, located east of Test Pit 1 and which is completely buried. The bottom of the surge tank is lower than that of the penstock, and is likely founded on rock. The surge tank feeds into the Pump House, which is known to be founded on bedrock. Insofar as all three structures were built at the same time, it is considered likely that the backfill and backfilling procedures were similar.

Based on a study of copies of a drawing showing cross-sections of "Manholes for 5 ft Valves above Power House" prepared in 1888, backfill to structures comprised "Rock and Earth from Excavation". Hence, the backfill may be sufficiently permeable to allow rapid drainage of groundwater from around buried structures located upstream of the eastern lock gate (Penstock and Surge Tank) to areas downstream of the eastern lock gate (Pump House). Such a pervious envelope around the penstock could intercept water migrating north from the shipping canal, and channel the water to the east. This may explain the lack of groundwater in Test Pit 1.

4.4 Recommendations for Future Action

Although there is incontrovertible evidence that the south west corner of the Canalman's Shelter and the south east corner of the Stores Building have experienced differential settlements in the past, it is not known if the settlements are still occurring. It was suggested in our first report that the rapid flow of groundwater from the head race of the power canal to the tail race of the shipping canal could have been a cause of the migration of fine soil particles into voids and hence the loss of ground from beneath these areas. With the completion of a relatively impermeable cut-off from the shipping canal to the power dam, it is reasonable to assume that this flow of water has been stemmed. Therefore, it is possible that the movement of the structures has ceased.

The injection of grout in the fill soils beneath the structures would prevent future ground movements. However, foundation stabilization by grouting is typically a costly solution.

It is therefore recommended that, as a first step, the Canalman's Shelter and the Stores Building be monitored to determine if the structures are experiencing further movement. If it can be determined that movement has ceased, then cosmetic repairs can be made to the structures to eliminate the obvious cracks and displacements. However, if movements are still occurring, then more expensive remedial measures such as grouting may be required.

Such a monitoring scheme could consist of pins installed on both sides of existing cracks. On a regular basis, e.g. monthly, the distance between the pins is measured, and this distance plotted on a graph versus time. These plots will give a clear picture of the relative movement across the cracks.

In addition to monitoring movement across the cracks, settlement points can be installed on the structures in question and the elevation of these points determined on a monthly basis. This information, when plotted, will indicate if any vertical deformation of the structures is occurring. It is recommended that four settlement points be installed on the corners of the Canalman's Shelter. Six points are recommended for the Stores Building: four on the corners with two at the midpoints of the east and west walls.

Furthermore, it may be desirable to install a set of settlement points over the concrete pavement outside the Stores Building and along the asphalt pavement beside the shipping canal. Monitoring these points would provide information on the vertical movement of these surfaces.

Fenco Engineers Inc.
November 15, 1985
Page 9.

CLOSURE

We trust that this report is sufficient for your present purposes. Please do not hesitate to contact us if we can be of further assistance.

Yours very truly
GEOCON INC.



B. Cooke, P.Eng.
Senior Project Engineer

BC:bg
T10829/42313

APPENDIX I

EXPLANATION OF THE FORM BORING LOG

This form summarizes both field information and selected laboratory test results obtained from each boring. An explanation of the various columns of the form follows.

DEPTH

This column gives the depth scale of the boring.

ELEVATION AND DEPTH

This column gives the elevation and depth of inferred geologic contacts. The elevation is referred to the datum shown in the general heading.

DESCRIPTION

This column gives a description of the soil based on visual examination of the samples and laboratory tests. Each stratum is described according to the following classification and terminology:

<u>Classification*</u>	<u>Particle Size</u>	<u>Particle Size or Sieve No. (U.S. Standard)</u>
Clay	less than 0.002 mm	less than 0.002 mm
Silt	from 0.002 to 0.075 mm	from 0.002 mm to #200 sieve
Sand	from 0.075 to 4.75 mm	from #200 sieve to #4 sieve
Gravel	from 4.75 mm to 75 mm	from #4 sieve to 3 in.
Cobbles	from 75 to 200 mm	from 3 in. to 8 in.
Boulders	larger than 200 mm	over 8 in.

<u>Terminology</u>	<u>Proportion</u>
Trace, or occasional	Less than 10%
Some	10 to 20%
Adjective (e.g. silty or sandy)	20 to 35%
And (e.g. sand and gravel)	35 to 50%

*Unified Soil Classification System (ASTM D2487-75).

The relative density of cohesionless soils and the consistency of cohesive soils are defined by the following:

<u>Relative Density</u>	<u>Penetration Resistance "N" Blows 0.3 m or Blows foot</u>	<u>Consistency</u>	<u>Undrained Shear Strength**</u>	
			<u>kPa</u>	<u>psf</u>
Very loose	0 to 4	Very soft	0 to 12	0 to 250
Loose	4 to 10	Soft	12 to 25	250 to 500
Compact	10 to 30	Firm	25 to 50	500 to 1000
Dense	30 to 50	Stiff	50 to 100	1000 to 2000
Very dense	over 50	Very stiff	100 to 200	2000 to 4000
		Hard	over 200	over 4000

** The compressive strength obtained from the quick (Q) triaxial test is equal to twice the shear strength of the clay.

SYMBOL

These standard symbols describe the stratigraphy of the soil and rock strata.

(Continued on reverse)

WAT LEVEL

This column shows the groundwater level in the boring measured on the date indicated. In impervious soils the accurate determination of ground water elevations by standpipe, casing or open-hole readings is not possible within the normal time frame of the completion of the site work, and the true groundwater level may be higher or lower than indicated. Where both pervious and impervious soil strata are penetrated, the groundwater levels in each layer may be at different levels and sealed piezometers or standpipes within the individual layers are required to establish true groundwater conditions. Water levels determined by a piezometer can be considered as reliable groundwater levels for the layer in which the piezometer tip is located.

TESTS

The central section of the log forms a graph which is used to plot selected field and laboratory test results, at the elevation at which they were carried out. The symbols and scales for the plotting are shown at the head of the column. The dynamic penetration test blows are the number of blows required to drive a 51 mm (2 in.) diameter cone a depth of 0.3 m (1 foot) using an energy of 480 joules (4200 lb.-in.). This test is carried out from the ground surface or beyond the cased depth of the borehole.

OTHER TESTS

This column shows the results or abbreviations of other field or laboratory tests which have been performed. An explanation of the abbreviations is given on the top of the form. The results of other tests not plotted on the form are given in an Appendix to the report.

SAMPLES

The first three columns describe the condition, type and number, as well as the percentage recovery, of each sample obtained from the boring. The location and condition of each sample is plotted to scale. The legend for sample condition is explained on the top left side of the form.

The last column shows the "N" value of the soil as determined by the Standard Penetration Test. The "N" value corresponds to the number of blows required to drive the last 0.3 m (1 foot) of a 51 mm (2 in.) diameter standard split spoon sampler with an energy of 480 joules (4200 lb.-in.). The Standard Penetration Test is carried out according to ASTM D1586-74.

Soil and rock samples will be stored for a one year period after which they will be discarded unless we are otherwise instructed.



Geocon

TEST PIT LOG

PROJECT Fenco Engineers Inc. TEST PIT 1
St. Mary's Island PAGE 1 OF 1
 CONTRACT NO. T10829/42313 DATE Nov 5&6/85
 DATUM Geodetic

SAMPLE CONDITION

DISTURBED

W_N - WATER CONTENT - %
 G_S - GRAIN SIZE ANALYSIS
 γ - UNIT WEIGHT - $\frac{KN}{m^3}$

TYPE OF TEST

P - MODIFIED PROCTOR TEST
 W_{OPT} - OPTIMUM WATER CONTENT - %
 γ_{MAX} - MAX DRY UNIT WEIGHT - $\frac{KN}{m^3}$

W_L - LIQUID LIMIT - %
 W_P - PLASTIC LIMIT - %

DEPTH - m		ELEVATION - m	DESCRIPTION	SYMBOL	SAMPLES		TESTS
DEPTH - m	DEPTH - m				CONDITION	NUMBER	
		184.35	GROUND SURFACE				
		184.05	Topsoil				
	0.30		Random fill - Cobbles, boulders, debris etc. in a sand/silt matrix				
	1	163.30	Till fill - Reddish brown silty sand and gravel with occasional cobbles and boulders				
	1.05						
	2						
	3						
	3	180.54	END OF TEST PIT				
	3.51		Note: Test Pit dry to 3.51 m depth on November 6, 1985.				
	4						



Geocon

TEST PIT LOG

PROJECT Fenco Engineers Inc.TEST PIT 2St. Mary's IslandPAGE 1 OF 1CONTRACT NO. T10829/42313DATE Nov 5&6/85DATUM Geodetic

SAMPLE CONDITION

 DISTURBEDW_w - WATER CONTENT - %G_S - GRAIN SIZE ANALYSISγ - UNIT WEIGHT - ^{KN}/m³

TYPE OF TEST

P - MODIFIED PROCTOR TEST

W_{OPT} - OPTIMUM WATER CONTENT - %γ_{MAX} - MAX DRY UNIT WEIGHT - ^{KN}/m³W_L - LIQUID LIMIT - %W_P - PLASTIC LIMIT - %

STRATIGRAPHY

SAMPLES

TESTS

DEPTH - m	ELEVATION - m	DEPTH - m	DESCRIPTION	SYMBOL	SAMPLES		TESTS
					CONDITION	NUMBER	
	79.25		TOP OF CONCRETE PAVEMENT (STORES BLDG)				
	179.15		Concrete				
	0.10		Fill - Organic silts, sands and gravel				
	178.95		Random fill - Cobbles, boulders and debris, etc. in a sand/silt matrix				
	0.30						
	178.49		Till fill - Reddish brown silty sand and gravel with occasional cobbles and boulders				
	0.76						
1	177.43		Pink silty sand and gravel till				
	1.83						
2	176.75		END OF TEST PIT				
	2.50						
3			Note: Water level at elevation 178.35 on November 6, 1985				
4							

100-200
100-200
100-200

Fenco

January 3, 1986

FENCO ENGINEERS INC
STATION TOWER 421 BAY STREET
SAULT STE MARIE ONTARIO
CANADA P6A 1N3
TEL (416) 290-8407

Parks Canada,
Ontario Region,
111 Water Street East
CORNWALL, ONTARIO.
K6H 6S3

Attention: Mr. C. Robitaille

Dear Sir:

SUBJECT: Soil Subsidence Investigation
Sault Ste. Marie Canal
Contract #84-55

We have completed the supplementary test hole program at the Canalman's Shelter and at the Stores Building. Enclosed are two copies of the detailed report, dated November 20, 1985, prepared by Geocon Inc. This report is supplemental to their original report dated September 10, 1984.

At your request we also carried out some preliminary investigation of the ground seepage experienced in September and October, 1985, north of the machine shop.

The phenomena seemed to occur coincidentally with westerly winds. An early theory which seemed to have some merit was that the water level in the headrace of the Great Lakes Power intake canal, increased as a result of prevailing westerlies, was topping the cut off dike installed parallel to the intake canal. In order to investigate that possibility we studied all available weather and water level records.

Lavalin

Parks Canada
Attention: Mr. C. Robitaille
January 3, 1986
Page 2

Copies of the following documents covering the months of September and October, 1985, were obtained:

- : Hourly/daily water levels, gauge #2/4630/08422, at the approach pier to the Sault Canal, from Marine Environmental Data Service.
- : Hourly water levels, at the headrace intake, from Great Lakes Power.
- : Monthly Meteorological Summary, Sault Ste. Marie Airport, from Environment Canada.

Although some correlation can be seen between the Great Lakes Power levels and the Wind Speed/Direction Data one over-riding fact comes to light. The highest recorded level at the Great Lakes Power intake was 183.3 (IGLD) and the top elevation of the clay core in the cut-off dyke is 185.15 (presumably Geodetic). Since IGLD is within 0.104 metres (lower) than Geodetic the datums can be considered similar for the purposes of this study. We see therefore, that the water level approached no closer than 1.85 m to the top of the dyke.

As the investigation progressed other pertinent facts came to light. If leakage from the canal was occurring through cracks in the core of the dyke, or by overtopping of the core, then it would seem reasonable that a general raising of the groundwater regime on the dry side of the dyke would occur.

Furthermore, the side slopes of the embankment would undoubtedly have displayed water run-off. None of the above was detected.

Mr. Ron Harrison, of the Sault Canal, had a test pit dug, 3 or 4 metres to the north of the seepage location and between the seepage and the clay dyke. The observed water level in the test pit was about 600 mm below the level of pavement through which the seepage was occurring.

Fenco

Parks Canada
Attention: Mr. C. Robitaille
January 3, 1986
Page 3

Drawings of this area show several buried water lines, some of which are labelled "non-operational". It is possible that surging in one of these lines is causing a large enough leak to produce the "spring" which appeared through the pavement. Small leaks would undoubtedly use the subterranean water courses established before the dyke was built.

We would recommend that steps be taken to excavate the area around the seepage in order to ascertain whether one of the pipes is leaking. This could, of course, be done under local maintenance and would require no further input from ourselves. If, however, you would require our involvement we would be most happy to oblige.

Yours very truly,

FENCO ENGINEERS INC.,

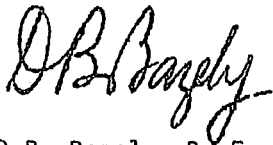

D.B. Bazely, P. Eng.,
MANAGER.

DBB/gp
42313

Encl. G.L.P. Levels
MEDS Levels
Enviro Canada Meteorological Summary
Geocon Report

cc: R. Harrison, Parks Canada, Sault Ste. Marie.

Lavalin

Rowswell and Associates Engineers Inc.
Additional Geotechnical Test Hole Investigation
Proposed Structural Stabilization of Stores Building
Sault Ste. Marie, Ontario
March 2014



APPENDIX C
BOREHOLE LOGS

RECORD OF BOREHOLE No. BH13-04 Co-Ord. 16T 0703316 E, 5154509 N



Project Number: TY1230281 Drilling Location: E Side Middle - Outside Stores Building Logged by: ARM
 Project Client: Roswell & Associates Engineers Inc. Drilling Method: 250 mm (10") mm Hollow Stem Augers Compiled by: MAT
 Project Name: NHSC Stores Building Additional Investigation Drilling Machine: Track Mounted Drill Reviewed by: DMB
 Project Location: Sault Ste. Marie, Ontario Date Started: 11 Dec 13 Date Completed: 12 Dec 13 Revision No.: 3, 07/02/14

LITHOLOGY PROFILE	SOIL SAMPLING				FIELD TESTING		LAB TESTING		INSTRUMENTATION INSTALLATION	COMMENTS
	DESCRIPTION	Sample Type	Sample Number	Recovery (%)	SPT 'N' Value	DEPTH (m)	ELEVATION (m)	Penetration Testing ○ SPT ● DCPT MTO Vane* Nilcon Vane* △ Intact ◇ Intact ▲ Remould ◆ Remould * Undrained Shear Strength (kPa) 15 30 45 60		
Local Ground Surface Elevation: 100.0 m										
CONCRETE steel reinforced										
99.6										
0.4										
brown / black FILL mostly sand, some gravel, silt and clay occasional cobbles / boulders damp to wet, very dense										
	SS	1	51	70		1.0	99.0	○		- spoon refusal
						1.5	98.5			
	SS	2	0			2.0	98.0			
						2.5	97.5	○		
97.7						3.0	97.0			
2.3						3.5	96.5	○		
brown to red SAND and GRAVEL some silt and clay moist, compact to dense						4.0	96.0			
	SS	3	75	21						
	SS	4	64	44						- spoon refusal
95.9										
4.1										
END OF BOREHOLE (monitoring well installed at inferred bedrock surface)										

AMEC Environment & Infrastructure
 A Division of AMEC Americas Limited
 131 Fielding Road
 Lively, Ontario
 Canada P3Y 1L7
 Tel +1(705) 682-2632
 Fax +1(705) 682-2260
 www.amec.com

▽ Groundwater depth on completion of drilling: 1.7 m. ■ Cave in depth recorded on completion of drilling at 3.8 m.
 ▼ Groundwater depth recorded on 17/12/2013 at a depth of 0.9 m

Borehole details as presented, do not constitute a thorough understanding of all potential conditions present and requires interpretative assistance from a qualified Geotechnical Engineer. Also, borehole information should be read in conjunction with the geotechnical report for which it was commissioned and the accompanying 'Explanation of Borehole Log'.

RECORD OF BOREHOLE No. BH13-05 Co-Ord. 16T 0703313 E, 5154504 N



Project Number: TY1230281 Drilling Location: NW Side - Outside Stores Machine Shop Logged by: ARM
 Project Client: Roswell & Associates Engineers Inc. Drilling Method: 100 mm Hollow Stem Augers Compiled by: MAT
 Project Name: NHSC Stores Building Additional Investigation Drilling Machine: Manual (250E) Reviewed by: DMB
 Project Location: Sault Ste. Marie, Ontario Date Started: 13 Dec 13 Date Completed: 13 Dec 13 Revision No.: 3, 07/02/14

LITHOLOGY PROFILE	SOIL SAMPLING				DEPTH (m)	ELEVATION (m)	FIELD TESTING	LAB TESTING	INSTRUMENTATION INSTALLATION	COMMENTS
	DESCRIPTION	Sample Type	Sample Number	Recovery (%)						
Local Ground Surface Elevation: 100.7 m										
brown / black FILL mostly sand, some gravel, silt and clay occasional cobbles / boulders mixed with metal debris and concrete	AU				100.5					
	RC	1	81		100.0					
	RC	2	46		99.5					
	RC	3	56		99.0					
	RC	4	30		98.0					
	RC	5	84		97.5					
brown to red SAND and GRAVEL some silt and clay moist, compact to dense	RC	4	30		98.0					- mud w/ sand
RC	5	84		97.5						
BEDROCK Precambrian (Proterozoic)-aged Jacobsville Formation sandstone rocks of the Southern and Superior Province. TCR 20/24 = 83% SCR 6.5/24 = 27% RQD 0/24 = 0%	RC	6	84		97.0					
END OF COREHOLE					96.5					

AMEC Environment & Infrastructure
 A Division of AMEC Americas Limited
 131 Fielding Road
 Lively, Ontario
 Canada P3Y 1L7
 Tel +1(705) 682-2632
 Fax +1(705) 682-2260
 www.amec.com

▽ Groundwater depth on completion of drilling: 1.2 m. ■ Cave in depth recorded on completion of drilling at 4.0 m.
 ▼ Groundwater depth recorded on 17/12/2013 at a depth of 1.2 m

Borehole details as presented, do not constitute a thorough understanding of all potential conditions present and requires interpretative assistance from a qualified Geotechnical Engineer. Also, borehole information should be read in conjunction with the geotechnical report for which it was commissioned and the accompanying 'Explanation of Borehole Log'.

RECORD OF BOREHOLE No. BH13-06 Co-Ord. 16T 0703300 E, 5154522 N



Project Number: TY1230281 Drilling Location: SW Side - Outside Stores Building Logged by: ARM
 Project Client: Roswell & Associates Engineers Inc. Drilling Method: 100 mm Hollow Stem Augers Compiled by: MAT
 Project Name: NHSC Stores Building Additional Investigation Drilling Machine: Manual (250E) Reviewed by: DMB
 Project Location: Sault Ste. Marie, Ontario Date Started: 14 Dec 13 Date Completed: 14 Dec 13 Revision No.: 3, 07/02/14

Lithology Plot	LITHOLOGY PROFILE	SOIL SAMPLING				DEPTH (m)	ELEVATION (m)	FIELD TESTING		LAB TESTING		INSTRUMENTATION INSTALLATION	COMMENTS
	DESCRIPTION	Sample Type	Sample Number	Recovery (%)	SPT 'N' Value			Penetration Testing	Atterberg Limits	W _p	W		
	Local Ground Surface Elevation: 100.6 m												
	red FILL mostly gravel, some sand and cobbles, concrete fragments damp to wet	RC	1	25		100.5							
						0.5							
						100.0							
						1.0							
						99.5							
						1.5							
		SS	2	21	40	99.0							
						2.0							
		RC	3	30		98.5							
						98.2							
						2.4							
	BEDROCK Precambrian (Proterozoic)-aged Jacobsville Formation sandstone rocks of the Southern and Superior Province. TCR 12/24 = 50% SCR 9/24 = 38% RQD 0/24 = 0% TCR 9/24 = 37% SCR 9/24 = 37% RQD 6/24 = 25%	RC	4	50		2.5							
						3.0							
		RC	5	38		3.5							
						3.0							
		RC	6	34		4.0							
						4.5							
		RC	7	65		4.5							
						4.5							
		RC	8	56		5.0							
						5.0							
						95.1							
	END OF COREHOLE					5.5							

AMEC Environment & Infrastructure
 A Division of AMEC Americas Limited
 131 Fielding Road
 Lively, Ontario
 Canada P3Y 1L7
 Tel +1(705) 682-2632
 Fax +1(705) 682-2260
 www.amec.com

▽ Groundwater depth on completion of drilling: 1.4 m. Cave in depth recorded on completion of drilling at 2.2 m.
 ▼ Groundwater depth recorded on 17/12/2013 at a depth of 1.4 m

Borehole details as presented, do not constitute a thorough understanding of all potential conditions present and requires interpretative assistance from a qualified Geotechnical Engineer. Also, borehole information should be read in conjunction with the geotechnical report for which it was commissioned and the accompanying 'Explanation of Borehole Log'.

RECORD OF BOREHOLE No. BH13-07



Project Number: TY1230281 Drilling Location: NE Side - Inside Shop Building Logged by: ARM
 Project Client: Roswell & Associates Engineers Inc. Drilling Method: 100 mm Hollow Stem Augers Compiled by: MAT
 Project Name: NHSC Stores Building Additional Investigation Drilling Machine: Manual (250 HiHi) Reviewed by: DMB
 Project Location: Sault Ste. Marie, Ontario Date Started: 12 Dec 13 Date Completed: 12 Dec 13 Revision No.: 3, 07/02/14

Lithology Profile	SOIL SAMPLING				DEPTH (m)	ELEVATION (m)	FIELD TESTING	LAB TESTING	INSTRUMENTATION INSTALLATION	COMMENTS
	DESCRIPTION	Sample Type	Sample Number	Recovery (%)						
Local Ground Surface Elevation: 100.0 m										
CONCRETE	AU									
99.8										
0.3										
brown and black FILL mostly sand, some gravel, silt and clay occasional cobbles / boulders damp to wet	SS	1	56	7	0.5	99.5	○			
99.1										
0.9										
brown to red SAND and GRAVEL some silt and clay moist, compact to dense	RC	2	48	50+	1.0	99.0	○			
	RC	3	60		1.5	98.5				
	RC	4	90		2.0	98.0				
	RC	5	41		2.5	97.5				
97.6										
2.4										
BEDROCK Precambrian (Proterozoic)-aged Jacobsville Formation sandstone rocks of the Southern and Superior Province. TCR 22/24 = 92% SCR 12/24 = 50% RQD 0/24 = 0%	RC	6	92		3.0	97.0				
97.0										
3.1										
END OF COREHOLE										

AMEC Environment & Infrastructure
 A Division of AMEC Americas Limited
 131 Fielding Road
 Lively, Ontario
 Canada P3Y 1L7
 Tel +1(705) 682-2632
 Fax +1(705) 682-2260
 www.amec.com

▽ Groundwater depth on completion of drilling: 1.7 m.

Borehole details as presented, do not constitute a thorough understanding of all potential conditions present and requires interpretative assistance from a qualified Geotechnical Engineer. Also, borehole information should be read in conjunction with the geotechnical report for which it was commissioned and the accompanying 'Explanation of Borehole Log'.

Scale: 1 : 35

Page: 1 of 1

RECORD OF BOREHOLE No. BH13-08



Project Number: TY1230281 Drilling Location: SE Corner - Inside Stores Building Logged by: ARM
 Project Client: Roswell & Associates Engineers Inc. Drilling Method: 200 mm Hollow Stem Augers Compiled by: MAT
 Project Name: NHSC Stores Building Additional Investigation Drilling Machine: Manual (250 HiHi) Reviewed by: DMB
 Project Location: Sault Ste. Marie, Ontario Date Started: 10 Dec 13 Date Completed: 11 Dec 13 Revision No.: 3, 07/02/14

Lithology Profile	DESCRIPTION	SOIL SAMPLING				DEPTH (m)	ELEVATION (m)	FIELD TESTING		LAB TESTING		INSTRUMENTATION INSTALLATION	COMMENTS
		Sample Type	Sample Number	Recovery (%)	SPT 'N' Value			Penetration Testing	Atterberg Limits				
	Local Ground Surface Elevation: 100.0 m												
	CONCRETE	AU											
	99.6												
	0.4												
	brown and black FILL mostly sand, some gravel, silt and clay occasional cobbles / boulders damp to wet	RC	1	38		0.5	99.5						
	99.1												
	0.9												
	brown to red SAND and GRAVEL some silt and clay moist, compact to dense	RC	2	37		1.0	99.0						
						1.5	98.5						
		RC	3	56		2.0	98.0						
						2.5	97.5						
		RC	4	62									
						3.0	97.0						
	3.0												
	BEDROCK Precambrian (Proterozoic)-aged Jacobsville Formation sandstone rocks of the Southern and Superior Province. TCR 25/25 = 100% SCR 16/25 = 64% RQD 4.5/25 = 18%	RC	5	33		3.5	96.5						
	TCR 11/22 = 50% SCR 10/22 = 45% RQD 8/22 = 36%	RC	6	71		4.0	96.0						
	TCR 15/26 = 58% SCR 6/26 = 23% RQD 0/26 = 0%	RC	7	0		4.5	95.5						
	TCR 14/25 = 56% SCR 2/25 = 8% RQD 0/25 = 0%	RC	8	0		5.0	95.0						
	TCR 24/24 = 100% SCR 23/24 = 96% RQD 18/24 = 75%	RC	9	75		5.5	94.5						
						6.0	94.0						
	93.6												
	6.4												
	END OF COREHOLE												

AMEC Environment & Infrastructure
 A Division of AMEC Americas Limited
 131 Fielding Road
 Lively, Ontario
 Canada P3Y 1L7
 Tel +1(705) 682-2632
 Fax +1(705) 682-2260
 www.amec.com

▽ Groundwater depth on completion of drilling: 0.8 m. Cave in depth recorded on completion of drilling at 2.6 m.
 ▼ Groundwater depth recorded on 17/12/2013 at a depth of 0.8 m

Borehole details as presented, do not constitute a thorough understanding of all potential conditions present and requires interpretative assistance from a qualified Geotechnical Engineer. Also, borehole information should be read in conjunction with the geotechnical report for which it was commissioned and the accompanying 'Explanation of Borehole Log'.

Rowswell and Associates Engineers Inc.
Additional Geotechnical Test Hole Investigation
Proposed Structural Stabilization of Stores Building
Sault Ste. Marie, Ontario
March 2014



APPENDIX D

MULTIURETHANES REPORT

Memo

To: Dan Cacciotti, P.Eng.

From: Peter White, P.Eng.

Date: January 15, 2014

Re: Sault Ste. Marie Canal NHSC Stores Building Foundation

1. Project correspondence with AMEC and Rowswell in March 2013 related to grouting of rubble stone foundation walls to a depth of 1.5 m, as well as consolidation of anticipated voids within the granular substrate from bottom of foundation walls to bedrock.

Prior investigations (AMEC/FENCO) encountered a few voids within boreholes and mentioned the potential for blast rock fill beneath the building foundations.

2. Recent borehole investigations (AMEC) indicate the existence of compact to dense silty sand and gravel from bottom of foundation walls to bedrock, as reported in previous investigations.

Relatively high SPT "N" values (where reported) within this material indicate soil conditions that are not amenable to cement grouting.

Significant proportions of silts and clays (approximately 20%) contained within this material matrix prohibit homogeneous penetration by cement grouting.

Recent pump test (AMEC) within the silty sand and gravel material encountered low hydraulic conductivity values (typical for a silty sand). The relatively low water pumping rate of 3 to 4 litres per minute indicates soil conditions that would not readily accept cement grout.

3. Based upon the recent geotechnical investigation and pump test results, it is concluded that cement grouting is not a viable alternative for stabilization of the substrate beneath the foundation walls, even if microfine cements are considered.

The relatively low permeability of the compact to dense silty sand also precludes practical grouting operations with a low viscosity chemical grout.

Memo

4. It is recommended that alternate means and methods be considered to provide long-term foundation support for the stores building.
5. Please contact me at your convenience by calling 416-919-1878 for any additional information that is required.

Regards

A handwritten signature in black ink that reads 'Peter White'.

Peter White

Rowswell and Associates Engineers Inc.
Additional Geotechnical Test Hole Investigation
Proposed Structural Stabilization of Stores Building
Sault Ste. Marie, Ontario
March 2014



APPENDIX E
LIMITATIONS OF REPORT

AMEC ENVIRONMENT & INFRASTRUCTURE

LIMITATIONS OF REPORT

The conclusions and recommendations given in this report are based on information determined at the test hole locations. The information contained herein in no way reflects on the environmental aspects of the project, unless otherwise stated. Subsurface and groundwater conditions between and beyond the test holes may differ from those encountered at the test hole locations, and conditions may become apparent during construction, which could not be detected or anticipated at the time of the site investigation. It is recommended practice that the geotechnical engineer be retained during construction to confirm that the subsurface conditions throughout the site do not deviate materially from those encountered in boreholes.

The design recommendations given in this report are applicable only to the project described in the text and then only if constructed substantially in accordance with the details stated in this report. Since all details of the design may not be known, we recommend that we be retained during the final design stage to verify that the design is consistent with our recommendations, and that assumptions made in our analysis are valid.

The comments made in this report on potential construction problems and possible methods are intended only for the guidance of the designer. The number of test holes may not be sufficient to determine all the factors that may affect construction methods and costs. For example, the thickness of surficial topsoil or fill layers may vary markedly and unpredictably. The contractors bidding on this project or undertaking the construction should, therefore, make their own interpretation of the factual information presented and draw their own conclusions as to how the subsurface conditions may affect their work. This work has been undertaken in accordance with normally accepted geotechnical engineering practices. No other warranty is expressed or implied.

Any use which a third party makes of this report, or any reliance on or decisions to be made based on it, are the responsibility of such third parties. AMEC accepts no responsibility for damages, if any, suffered by any third party as a result of decisions made or actions based on this report.