



SPECIFICATIONS

SOLICITATION #: 15-22047

BUILDING: BOU
75 de Mortagne Blvd
Boucherville, QC

PROJECT: BOU – Roofing Warehouse and L-1 L-2

PROJECT #: BOU-14125

Date: July 2015

SPECIFICATION

TABLE OF CONTENTS

Construction Tender Form

Buyandsell Notice

Instructions to Bidders

Acceptable Bonding Companies

Articles of Agreement

Plans and Specifications

A

Terms of Payment

B

General Conditions

C

Labour Conditions and Fair Wage Schedule	D
N/A	
Insurance Conditions	E
Contract Security Conditions	F
Security Requirement Check List	G

National Research Council Conseil national de recherches
Canada Canada

Administrative Services Direction des services
& Property management administratif et gestion
Branch (ASPM) de l'immobilier (SAGI)

Construction Tender Form

Project Identification **BOU – Roofing Warehouse and L-1 L-2**

Tender No.: **15-22047**

1.2 Business Name and Address of Tenderer

Name _____

Address _____

Contact Person(Print Name) _____

Telephone (_____) _____ **Fax:** (_____) _____

1.3 Offer

I/We the Tenderer, hereby offer to Her Majesty the Queen in Right of Canada (hereinafter referred to as “Her Majesty”) represented by the National Research Council Canada to perform and complete the work for the above named project in accordance with the Plans and Specifications and other Tender Documents, at the place and in the manner set out therein for the Total Tender Amount (to be expressed in numbers only) of: \$_____. _____ **in lawful money of Canada (excluding GST/HST)**

The above amount is inclusive of all applicable (*) Federal, Provincial and Municipal taxes except that in the event of a change in any tax imposed under the Excise Act, the Excise Tax Act, the Old Age Security Act, the Customs Act, the Customs Tariff or any provincial sales tax legislation imposing a retail sales tax on the purchase of tangible personal property incorporated into Real Property, that occurs

- .1 after the date this tender was mailed or delivered, or
- .2 if this tender is revised, after the date of the last revision

the amount of this offer shall be decreased or decreased in the manner provided for in GC22 of the General Conditions of the Contract Documents.

National Research Council Canada	Conseil national de recherches Canada
Administrative Services & Property management Branch (ASPM)	Direction des services administratif et gestion de l'immobilier (SAGI)

1.3.1 Offer (continued)

(*) For the purpose of this tender, the Goods and Services Tax (GST) is not to be considered as an applicable tax.

In the province of Quebec, the Quebec Sales Tax is not to be included in the tender amount because the Federal Government is exempt from this tax. Tenderers shall make arrangements directly with the provincial Revenue Department to recover any tax they may pay on good and servives acquired in the performance of this contract. However, tenderers should include in their tender amount Quebec Sales Tax for which an Input Tax Refund is not available.

1.4 Acceptance and Entry into Contract

I/We undertake, within fourteen (14) days of notification of acceptance of my/our offer, to sign a contract for the performance of the work provided I/we are notified, by the Department, of the acceptance of my/our offer within 30 days of the tender closing date.

1.5 Construction Time

I/We Agree to complete the work within the time stipulated in the specification from the date of notification of acceptance of my/our offer.

1.6 Bid Security

I/We herewith enclose tender security in accordance with Article 5 of the General Instruction to Tenderers.

I/We understand that if a security deposit is furnished as tender security and if I/we refuse to enter into a contract when called upon to do so, my/our security deposit shall be forfeited but the Minister may, if it is in the public interest, waive the right of Her Majesty to forfeit the security deposit.

I/We understand that if the security furnished is not in the approved form as described in Article 5 of the General Instructions to Tenderers, my/our tender is subject to disqualification.

National Research Council Canada	Conseil national de recherches Canada
-------------------------------------	--

Administrative Services & Property management Branch (ASPM)	Direction des services administratif et gestion de l'immobilier (SAGI)
---	--

1.7 Contract Security

Within fourteen (14) days after receipt of written notification of the acceptance of my/our offer, I/we will furnish contract security in accordance with the Contract Conditions "F" of the Contract Documents.

I/We understand that the contract security referred to herein, if provided in the form of a bill of exchange, will be deposited into the Consolidated Revenue Fund of Canada.

1.8 Appendices

This Tender Form includes Appendix No. ____N/A_____.

1.9 Addenda

The Total Tender Amount provides for the Work described in the following Addenda:

NUMBER	DATE	NUMBER	DATE

(Tenderers shall enter numbers and dates of addenda)

National Research Council Canada	Conseil national de recherches Canada
-------------------------------------	--

Administrative Services & Property management Branch (ASPM)	Direction des services administratif et gestion de l'immobilier (SAGI)
---	--

1.10 Execution of Tender

The Tenderer shall refer to Article 2 of the General Instructions to Tenderers.

**SIGNED, ATTESTED TO AND DELIVERED on the _____ day of
_____ on behalf of**

(Type or print the business name of the Tenderer)

AUTHORIZED SIGNATORY (IES)

(Signature of Signatory)

(Print name & Title of Signatory)

(Signature of Signatory)

(Print name & Title of Signatory)

SEAL

BUYANDSELL NOTICE

BOU – Roofing Warehouse and L-1 L-2

The National Research Council Canada, 75 de Mortagne Blvd, Boucherville, QC has a requirement for a project that includes:

Roofing, Warehouse and L1-L2 sector

1. GENERAL:

Questions regarding any aspect of the project are to be addressed to and answered only by the Departmental Representative (or his designate) or the Contracting Authority.

Any information received other than from the Departmental Representative (or his designate) or the Contracting Authority will be disregarded when awarding the contract and during construction.

Firms intending to submit tenders on this project should obtain tender documents through the Buyandsell.gc.ca TMA services provider. Addenda, when issued, will be available from the Buyandsell.gc.ca TMA service provider. Firms that elect to base their bids on tender documents obtained from other sources do so at their own risk and will be solely responsible to inform the tender calling authority of their intention to bid. Tender packages are not available for distribution on the actual day of tender closing.

2. MANDATORY SITE VISIT:

It is mandatory that the bidder attends one of the site visits at the designated date and time. At least one representative from proponents that intend to bid must attend.

The site visits will be held on July 9th and July 10th, 2015 at **10:00**. Meet Martin Legris at BOU Building, 75 de Mortagne Blvd, Boucherville, QC. Bidders who, for any reason, cannot attend at the specified date and time will not be given an alternative appointment to view the site and their tenders, therefore, will be considered as non-responsive. **NO EXCEPTIONS WILL BE MADE.**

As proof of attendance, at the site visit, the Contracting Authority will have an Attendance Form which **MUST** be signed by the bidder's representative. It is the responsibility of all bidders to ensure they have signed the Mandatory Site Visit Attendance form prior to leaving the site. Proposals submitted by bidders who have not attended the site visit or failed to sign the Attendance Form will be deemed non-responsive.

3. TENDER CLOSING DATE:

Tender closing date is July 23rd, 2015 at 14:00.

4. TENDER RESULTS

Following the Tender closing, the tender results will be sent by facsimile to all Contractors who submitted a tender.

5. SECURITY REQUIREMENT FOR CANADIAN CONTRACTORS

5.1 MANDATORY SECURITY REQUIREMENT:

.1 All personnel that will be involved with the project must be security screened to **RELIABILITY** status level as defined in the security policy of Canada.

6.0 WSIB (WORKPLACE SAFETY AND INSURANCE BOARD)

.1 All Bidders must provide a valid WSIB certificate with their Tender or prior to contract award.

7.0 OFFICE OF THE PROCUREMENT OMBUDSMAN

.1 Dispute Resolution Services

The parties understand that the Procurement Ombudsman appointed pursuant to Subsection 22.1(1) of the *Department of Public Works and Government Services Act* will, on request or consent of the parties to participate in an alternative dispute resolution process to resolve any dispute between the parties respecting the interpretation or application of a term and condition of this contract and their consent to bear the cost of such process, provide to the parties a proposal for an alternative dispute resolution process to resolve their dispute. The Office of the Procurement Ombudsman may be contacted by telephone at 1-866-734-5169 or by e-mail at boa.opo@boa-opo.gc.ca.

.2 Contract Administration

The parties understand that the Procurement Ombudsman appointed pursuant to Subsection 22.1(1) of the *Department of Public Works and Government Services Act* will review a complaint filed by [*the supplier or the contractor or the name of the entity awarded this contract*] respecting administration of this contract if the requirements of Subsection 22.2(1) of the *Department of Public Works and Government Services Act* and Sections 15 and 16 of the *Procurement Ombudsman Regulations* have been met, and the interpretation and application of the terms and conditions and the scope of the work of this contract are not in dispute. The Office of the Procurement Ombudsman may be contacted by telephone at 1-866-734-5169 or by e-mail at boa.opo@boa-opo.gc.ca.

.3 The Office of the Procurement Ombudsman (OPO) was established by the Government of Canada to provide an independent avenue for suppliers to raise complaints regarding the award of contracts under \$25,000 for goods and under \$100,000 for services. You have the option of raising issues or concerns regarding the solicitation, or the award resulting from it, with the OPO by contacting them by telephone at 1-866-734-5169 or by e-mail at boa.opo@boa-opo.gc.ca. You can also obtain more information on the OPO services available to you at their website at www.opo-boa.gc.ca.

The Departmental Representative or his designate for this project is: **Martin Legris**
Telephone: **450 641-5248**

Contracting Authority for this project is: **Marc Bédard** marc.bedard@nrc-cnrc.gc.ca
Telephone: **613 993-2274**

INSTRUCTIONS TO BIDDERS

Article 1 – Receipt of Tender

- 1a) Tenders must be received not later than the specified tender closing time. Tenders received after this time are invalid and shall not be considered, regardless of any reason for their late arrival.
- 1b) A letter of printed telecommunication from a bidder quoting a price shall not be considered as a valid tender unless a formal tender has been received on the prescribed Tender Form.
- 1c) Bidders may amend their tenders by letter or printed telecommunication provided that such amendments are received not later than the specified tender closing time.
- 1d) Any amendments to the tender which are transmitted by telefax must be signed and must clearly identify the tenderer.

All such amendments are to be addressed to:
National Research Council of Canada
Marc Bedard, Senior Contracting Officer
Building M-22
Montreal Road, Ottawa, Ontario
K1A 0R6

Fax: (613) 991-3297

Article 2 – Tender Form & Qualifications

- 1) All tenders must be submitted on the Construction Tender Form and the tender must be signed in compliance with the following requirements:
 - a) Limited Company: The full names of the Company and the name(s) and status of the authorized signing officer(s) must be printed in the space provided for that purpose. The signature(s) of the authorized officer(s) and the corporate seal must be affixed.
 - b) Partnership: The firm name and the name(s) of the person(s) signing must be printed in the space provided. One or more of the partners must sign in the presence of a witness who must also sign. An adhesive coloured seal must be affixed beside each signature.
 - c) Sole Proprietorship : The business name and the name of the sole proprietor must be printed in the space provided. The sole proprietor must sign in the presence of a witness who must also sign. An adhesive coloured seal must be affixed beside each signature.
- 2) Any alterations in the printed part of the Construction Tender Form or failure to provide the information requested therein, may render the tender invalid.
- 3) All space in the Construction Tender Form must be completed and any handwritten or typewritten corrections to the parts so completed must be initialed immediately to the side of the corrections by the person or persons executing the tender on behalf of the the tenderer.
- 4) Tenders must be based on the plans, specifications and tender documents provided.

Article 3 - Contract

- 1) The Contractor will be required to sign a contract similar to the Standard Contract Form for Fixed Price Construction Contracts, a blank specimen of which is enclosed in the package for reference purposes.

Article 4 – Tender Destination

- 1a) Tenders are to be submitted in sealed envelopes to:
National Research Council Canada
Administrative Services and Property Management Branch
BOU Building
75 de Mortagne Blvd
Boucherville, QC
J4B 6Y4

Endorsed "Tender for (insert title of work as it appears in the drawings and specifications)" and must bear the name and address of the tenderer.

- 1b) Unless otherwise specified, the only documents required to be submitted with the tender are the Tender form and the Bid Security.

Article 5 - Security

- 1a) Bid Security is required and must be submitted in one of the following forms:

- i) a certified cheque payable to the Receiver General for Canada and drawn on a member of the Canadian Payments Association or a local cooperative credit society that is a member of a central cooperative credit society having membership in the Canadian Payments Association; **OR**
- ii) bonds of the Government of Canada, or bonds unconditionally guaranteed as to principal and interest by the Government of Canada; **OR**
- iii) a bid bond.

- 1b) Regardless of the Bid Security submitted, it should never be more than \$250,000 maximum, calculated at 10% of the first \$250,000 of the tendered price, plus 5% of any amount in excess of \$250,000.

- 2a) Bid Security shall accompany each tender or, if forwarded separately from the tender, shall be provided not later than the specified tender closing time. Bid Security must be in the **ORIGINAL** form. Fax or photocopies and **NOT** acceptable. **FAILURE TO PROVIDE THE REQUIRED BID SECURITY SHALL INVALIDATE THE TENDER.**

- 2b) If the tender is not accepted, the Bid Security submitted pursuant to Article 8 shall be returned to the tenderer.

- 3a) The successful tenderer is required to provide security within 14 days of receiving notice of tender acceptance. The tenderer must furnish **EITHER**:

- i) a Security Deposit as described in 1(b) above together with a Labour and Material Payment Bond in the amount of at least 50% of the amount payable under the contract, **OR**

- ii) a Performance Bond and a Labour and Material Payment Bond – each in the amount of 50% of the amount payable under the contract.
- 3b) Should it not be possible to obtain a Labour Material Payment Bond as required under 3(a) above, on making application thereof to at least two acceptable Bonding Companies, an additional Security Deposit of a straight 10% of the amount payable under the contract must be furnished.
- 3c) Where a tender has been accompanied by a Security Deposit, as described in 1(b) above, the amount of the Security Deposit required under 3(a) above may be reduced by the amount of the Security Deposit which accompanied the tender.
- 3d) Bonds must be in an approved form and from the companies whose

bonds are acceptable to the Government of Canada. Samples of the approved form of Bid Bond, Performance Bond and Labour and Material Payment Bond and a list of acceptable Bonding Companies may be obtained from the Contracting Officer, National Research Council, Building M-22, Montreal Road, Ottawa, Ontario, K1A 0R6.

Article 6 – Interest On Security Deposits

- 1) Tenderers are notified that they must make their own arrangements with their bankers as to the interest, if any, on the amount of the certified cheque accompanying their tender. The Council will not pay interest on said cheque pending the awarding of the contract nor be responsible for the payments of interest under any arrangement made by the tenderers.

Article 7 – Sales Tax

- 1) The amount of the tender shall include all taxes as levied under the Excise Act, the Excise Tax Act, the Old Age Security Act, the Customs Act or the Customs Tariff, in force or applicable at the time.
- 2) In Quebec, the Provincial Sales Tax should not be included in the Tender Price as the Federal Government is exempt. Tenderers should contact the Provincial Revenue Minister to recover all taxes paid for goods and services rendered under this contract.

Tenderers must include in their Tender Price the amount of Provincial Sales Tax for which the exemption does not apply.

Article 8 – Examination of Site

- 1) All parties tendering shall examine the sites of the proposed work before sending in their tender and make themselves thoroughly acquainted with the same and obtain for themselves any and all information that may be necessary for the proper carrying out of the Contract. No after claim will be allowed or entertained for any work or material that may be requisite and necessary for the proper execution and completion of this Contract with the exception of that provided for under GC 35 in the General Conditions of the General Specification.

Article 9 – Discrepancies, Omissions, Etc.

- 1a) Bidders finding discrepancies in, or omissions from, drawings, specifications or other documents, or having any doubt as to the meaning or intent of any part thereof, should at once notify the Engineer who will send written instructions or explanation to all bidders.
- 1b) Neither the Engineer nor the Council will be responsible for oral instructions.
- 1c) Addenda or corrections issued during the time of the bidding shall be covered in the proposal. However, the contract supersedes all communications, negotiations and agreements, either written or oral, relating to the work and made prior to the date of the contract.

Article 10 – No additional Payments for Increased Costs

- 1) The only other adjustments in the contract price allowed are those specified in the General Conditions of the General Specification. The contract price will not be amended for change in freight rates, exchange rates, wage rates or cost of materials, plant or services.

Article 11 – Awards

- 1a) The Council reserves the power and right to reject tenders received from parties who cannot show a reasonable acquaintance with and preparation for the proper performance of the class of work herein specified and shown on plans. Evidence of such competence must be furnished by the tenderers if required to do so.
- 1b) A tenderer may be required to furnish to the Contracting Office, National Research Council of Canada, Building M-22, 1200 Montreal Road, Ottawa, Ontario, K1A 0R6, Canada, unsigned copies of the insurance requirements as covered by the Insurance Conditions of the General Specification.
- 1c) The Council does not bind itself to accept the lowest or any tender.

Article 12 – Harmonized Sales Tax

- 1) The Harmonized Sales Tax (HST) which is now in effect shall be considered an applicable tax for the purpose of this tender. However, the bidder shall NOT include any amount in the bid price for said HST. The successful contractor will indicate on each application for payment as a separate amount the appropriate HST the Owner is legally obliged to pay. This amount will be paid to the Contractor in addition to the amount certified for payment under the Contract in addition to the amount certified for payment under the Contract and will therefore not affect the Contract Price. The Contractor agrees to remit any HST collected or due to Revenue Canada.

Acceptable Bonding Companies

Published September 2010

The following is a list of insurance companies whose bonds may be accepted as security by the government.

1. Canadian Companies

- ACE INA Insurance
- Allstate Insurance Company of Canada
- Ascentus Insurance Ltd. (Surety only)
- Aviva Insurance Company of Canada
- AXA Insurance (Canada)
- AXA Pacific Insurance Company
- Canadian Northern Shield Insurance Company
- Certas Direct Insurance Company (Surety only)
- Chartis Insurance Company of Canada (formerly AIG Commercial Insurance Company of Canada)
- Chubb Insurance Company of Canada
- Commonwealth Insurance Company
- Co-operators General Insurance Company
- CUMIS General Insurance Company
- The Dominion of Canada General Insurance Company
- Echelon General Insurance Company (Surety only)
- Economical Mutual Insurance Company
- Elite Insurance Company
- Everest Insurance Company of Canada
- Federated Insurance Company of Canada
- Federation Insurance Company of Canada
- Gore Mutual Insurance Company
- Grain Insurance and Guarantee Company
- The Guarantee Company of North America
- Industrial Alliance Pacific General Insurance Corporation
- Intact Insurance Company
- Jevco Insurance Company (Surety only)
- Lombard General Insurance Company of Canada
- Lombard Insurance Company
- Markel Insurance Company of Canada
- The Missisquoi Insurance Company
- The Nordic Insurance Company of Canada
- The North Waterloo Farmers Mutual Insurance Company (Fidelity only)
- Novex Insurance Company (Fidelity only)
- The Personal Insurance Company
- Pilot Insurance Company
- Quebec Assurance Company
- Royal & Sun Alliance Insurance Company of Canada
- Saskatchewan Mutual Insurance Company
- Scottish & York Insurance Co. Limited
- The Sovereign General Insurance Company
- TD General Insurance Company
- Temple Insurance Company

- Traders General Insurance Company
- Travelers Guarantee Company of Canada
- Trisura Guarantee Insurance Company
- The Wawanesa Mutual Insurance Company
- Waterloo Insurance Company
- Western Assurance Company
- Western Surety Company

2. Provincial Companies

Surety bonds issued by the following companies may be accepted provided that the contract of suretyship was executed in a province in which the company is licensed to do business as indicated in brackets.

- AXA Boreal Insurance Company (P.E.I., N.B., Que., Ont., Man., B.C.)
- AXA Boreal Insurance Company (P.E.I., N.B., Que., Ont., Man., B.C.)
- ALPHA, Compagnie d'Assurances Inc. (Que.)
- Canada West Insurance Company (Ont., Man., Sask, Alta., B.C., N.W.T.) (Surety only)
- The Canadian Union Assurance Company (Que.)
- La Capitale General Insurance Inc. (Nfld. & Lab., N.S., P.E.I., Que.(Surety only), Man., Sask., Alta., B.C., Nun., N.W.T., Yuk.)
- Coachman Insurance Company (Ont.)
- Continental Casualty Company (Nfld. & Lab., N.S., P.E.I., N.B., Que., Ont., Man., Sask., Alta., B.C., Nun., N.W.T., Yuk.)
- GCAN Insurance Company (Nfld. & Lab., N.S., P.E.I., N.B., Que., Ont., Man., Sask., Alta., B.C., Nun., N.W.T., Yuk.)
- The Insurance Company of Prince Edward Island (N.S., P.E.I., N.B.)
- Kingsway General Insurance Company (N.S., N.B., Que., Ont., Man., Sask., Alta., and B.C.)
- Liberty Mutual Insurance Company (Nfld. & Lab., N.S., P.E.I., N.B., Que., Ont., Man., Sask., Alta., B.C., Nun., N.W.T., Yuk.)
- Manitoba Public Insurance Corporation (Man.)
- Norgroupe Assurance Générales Inc.
- Orleans General Insurance Company (N.B., Que., Ont.)
- Saskatchewan Government Insurance Office (Sask.)
- SGI CANADA Insurance Services Ltd. (Ont., Man., Sask., Alta.)
- L'Unique General Insurance Inc. (Nfld. & Lab., N.S., P.E.I., N.B., Que.(Surety only), Ont.(Surety only), Man., Sask., Alta., B.C.(Surety only), Nun., N.W.T., Yuk.)

3. Foreign Companies

- Aspen Insurance UK Limited
- Compagnie Française d'Assurance pour le Commerce Extérieur (Fidelity only)
- Eagle Star Insurance Company Limited
- Ecclesiastical Insurance Office Public Limited Company (Fidelity only)
- Lloyd's Underwriters
- Mitsui Sumitomo Insurance Company, Limited
- NIPPONKOA Insurance Company, Limited
- Sompo Japan Insurance Inc.
- Tokio Marine & Nichido Fire Insurance Co., Ltd.
- XL Insurance Company Limited (Surety only)
- Zurich Insurance Company Ltd

Articles of Agreement

Standard Construction Contract – Articles of Agreement
(23/01/2002)

- A1 Contract Documents
- A2 Date of Completion of Work and Description of Work
- A3 Contract Amount
- A4 Contractor's Address
- A5 Unit Price Table

Articles of Agreement

These Articles of Agreement made in duplicate this day of .

Between

Her Majesty the Queen, in right of Canada (referred to in the contract documents as “ Her Majesty”) represented by the National Research Council Canada (referred to in the contract documents as the “Council”)

and

(referred to in the contract documents as the “Contractor”)

Witness that in consideration for the mutual promises and obligations contained in the contract, Her Majesty and the Contractor covenant and agree as follows:

A1 Contract Documents

(23/01/2002)

1.1 Subject to A1.4 and A1.5, the documents forming the contract between Her Majesty and the Contractor, referred to herein as the contract documents, are

1.1.1 these Articles of Agreement,

1.1.2 the document attached hereto, marked “A” and entitled “Plans and Specifications”, referred to herein as the Plans and Specifications,

1.1.3 the document attached hereto, marked “B” and entitled “Terms of Payment”, referred to herein as the Terms of Payment,

1.1.4 the document attached hereto, marked “C” and entitled “General Conditions”, referred to herein as the General Conditions,

1.1.5 the document attached hereto, marked “D” and entitled “Labour Conditions”, referred to herein as the Labour Conditions,

1.1.6 the document attached hereto, marked “E” and entitled “Insurance Conditions”, referred to herein as the Insurance Conditions,

1.1.7 the document attached hereto, marked “F” and entitled “Contract Security Conditions”, referred to herein as the Contract Security Conditions, and

1.1.8 any amendment or variation of the contract documents that is made in accordance with the General Conditions.

1.1.9 the document entitled Fair Wage Schedules for Federal Construction Contracts referred to herein as Fair Wage Schedules

1.1.10

Articles of Agreement

The Council hereby designates _____ of _____ of the Government of Canada as the Engineer for the purposes of the contract, and for all purposes of or incidental to the contract, the Engineer's address shall be deemed to be:

1.2 In the contract

1.3.1 "Fixed Price Arrangement" means that part of the contract that prescribes a lump sum as payment for performance of the work to which it relates; and

1.3.2 "Unit Price Arrangement" means that part of the contract that prescribes the product of a price multiplied by a number of units of measurement of a class as payment for performance of the work to which it relates.

1.3 Any of the provisions of the contract that are expressly stipulated to be applicable only to a Unit Price Arrangement are not applicable to any part of the work to which a Fixed Price Arrangement is applicable.

1.4 Any of the provisions of the contract that are expressly stipulated to be applicable only to a Fixed Price Arrangement are not applicable to any part of the work to which a Unit Price Arrangement is applicable.

A2 Date of Completion of Work and Description of Work

(23/01/2002)

2.1 The contractor shall, between the date of these Articles of Agreement and the _____, _____, in the careful and workmanlike manner, diligently perform and complete the following work:

which work is more particularly described in the Plans and Specifications.

Articles of Agreement

A3 Contract Amount

(23/01/2002)

- 3.1 Subject to any increase, decrease, deduction, reduction or set-off that may be made under the Contract, Her Majesty shall pay the Contractor at the times and in the manner that is set out or referred to in the Terms of Payment
- 3.1.1 the sum of _____ (GST/HST extra), in consideration for the performance of the work or the part thereof that is subject to Fixed Price Arrangement, and
- 3.1.2 a sum that is equal to the aggregate of the products of the number of units of Measurement of each class of labour, plant and material that is set out in a Final Certificate of Measurement referred to in GC44.8 multiplied in each case by the appropriate unit price that is set out in the Unit Price Table in consideration for the performance of the work or the part thereof that is subject to a Unit Price Arrangement.
- 3.2 For the information and guidance of the Contractor and the persons administering the contract on behalf of Her Majesty, but not so as to constitute a warranty, representation or undertaking of any nature by either party, it is estimated that the total amount payable by Her Majesty to the Contractor for the part of the work to which a Unit Price Arrangement is applicable will be approximately \$N/A
- 3.3 A3.1.1 is applicable only to a Fixed Price Arrangement.
- 3.4 A3.1.2 and A3.2 applicable only to a Unit Price Arrangement.

A4 Contractor's Address

(23/01/2002)

- 4.1 For all purposes of or incidental to the contract, the Contractor's address shall be deemed to be:

Articles of Agreement

A5 Unit Price Table

(23/01/2002)

5.1 Her Majesty and the Contractor agree that the following table is the Unit Price Table for the purposes of the contract.

Column 1 Item	Column 2 Class of Labour Plant Or Material	Column 3 Unit of Measurement	Column 4 Estimated Total Quantity	Column 5 Price per Unit	Column 6 Estimated Total Price
		N/A			

5.2 The Unit Price Table that is set out in A5.1 designates the part of the work to which a Unit Price Arrangement is applicable.

5.3 The part of the work that is not designated in the Unit Price Table referred to in A5.2 is the part of the work to which a Fixed Price Arrangement is applicable.

Articles of Agreement

Signed on behalf of Her Majesty by

as Senior Contracting Officer

and _____

as _____

of the **National Research Council Canada**

on the _____

day of _____

Signed, sealed and delivered by

as _____ and
Position

by _____

as _____ and
Position

of

on the _____

day of _____

Seal

Description des travaux :

Les travaux visés par le présent contrat comprennent les Travaux de réfection complète de l'étanchéité de la toiture d'une section du bâtiment, soit dans la zone Entrepôt ainsi qu'une partie du bassin secteur L1-L2. Les travaux inclus aussi l'ajout d'un nouvel accès au toit dans le secteur de l'entrepôt
Les travaux sont réalisés dans l'édifice de Boucherville du Conseil national de recherches.

L'objectif des travaux :

De procéder à des travaux d'étanchéité du système de toiture inversé tout en conservant les panneaux d'isolants en polystyrène extrudé de 90 mm existants.
Le couvreur aura à réaliser en chantier des fenêtres exploratoires de dimensions approximatives de (24'' x 24'') et ceux-ci seront localisés en chantier avec le client et le professionnel surveillant des travaux. (Laboratoire).
Le nombre prévu est de (4) quatre fenêtres d'exploration dans la zone de la superficie de 2 177,62 m.ca. et de (2) deux fenêtres d'exploration dans la zone de la superficie de 425,24 m.ca.

L'état des matériaux existants :

L'entrepreneur doit prévoir en démolition de procéder à la récupération du substrat existant en toiture de toute la pierre de rivière afin de la réutiliser à nouveau suite aux travaux de l'étanchéité de la toiture. L'entrepreneur doit conserver les panneaux isolants existants s'il sont été jugés en bon état suite aux pluies d'exploration et suite à l'approbation de leur état par le professionnel surveillant des travaux. (Laboratoire).

L'entrepreneur doit procéder au démantèlement à des travaux aux murets en toiture à l'intérieur. Il doit procéder au démantèlement des revêtements intérieurs. Soit l'enlèvement du parement en en tôle d'acier en type corrugué ainsi que en clin de parement en AD-300.
L'entrepreneur doit conserver les matelas thermiques existants de 4'' d'ép. Sauf si celui-ci est abîmé par l'humidité.

Réalisation des travaux sur le site :

L'entrepreneur doit coordonner son calendrier des travaux avec le client afin de réaliser des travaux près des puits d'aération des laboratoires. Certaines opérations des laboratoires seront limitées momentanément par les opérations du client pour une question de sécurité du personnel de l'entrepreneur en toiture.

Tous les travaux de réfection de l'étanchéité en bordure des équipements et des sorties au toit sont à coordonner avec le client. (trappes d'aération, cheminée et autres).

L'entrepreneur doit en tout temps réalisés ses travaux en présence du surveillant mandaté du laboratoire accrédité de l'A.M.C.Q.

1. OUVRAGES ET MATÉRIAUX FOURNIS PAR LE PROPRIÉTAIRE

- .1 Les ouvrages et matériaux non inclus dans ce contrat sont décrits sur les dessins et dans le devis.
- .2 Tous les matériaux retournés au Propriétaire doivent être transportés à un lieu d'entreposage désigné par le représentant ministériel.
- .3 Sauf indication contraire, prendre possession des matériaux fournis par le Propriétaire à leur lieu d'entreposage et assurer leur transport.
- .4 Responsabilités de l'Entrepreneur :
 - .1 les décharger à pied d'œuvre;
 - .2 en faire aussitôt l'inspection et signaler tout article endommagé ou défectueux;
 - .3 par écrit, informer le représentant ministériel des articles qui sont reçus en bon état;
 - .4 les manutentionner à pied d'œuvre, ce qui comprend leur déballage et leur entreposage;
 - .5 Réparer ou remplacer les articles endommagés au chantier.
 - .6 Installer et raccorder les produits finis conformément aux prescriptions.

2. CONDITIONS DE TRAVAIL ET ÉCHELLE DES JUSTES SALAIRES

- .1 Se conformer à toutes les conditions de travail recommandées par le Ministère du développement des ressources humaines du Canada, Programme du travail, y compris celles énumérées à l'Annexe "D" intitulée: "Conditions de travail et échelle des justes salaires".

3. SYSTÈME D'INFORMATION SUR LES MATIÈRES DANGEREUSES UTILISÉES AU TRAVAIL (SIMDUT)

- .1 L'entrepreneur doit se conformer aux lois fédérales et provinciales portant sur le SIMDUT. Les responsabilités de l'entrepreneur comprennent les tâches suivantes, sans s'y limiter :
 - .1 S'assurer de l'étiquetage acceptable de tout produit contrôlé introduit sur les lieux des travaux par l'entrepreneur lui-même ou un sous-traitant, ou l'un de leurs fournisseurs;
 - .2 Mettre à la disposition des travailleurs et du représentant ministériel des fiches techniques « santé - sécurité » (FTSS) portant sur ces produits contrôlés;
 - .3 Former ses propres ouvriers pour le SIMDUT et les produits contrôlés présents au chantier;
 - .4 Informer les autres entrepreneurs, les sous-traitants, le représentant ministériel, les visiteurs autorisés, ainsi que les représentants des organismes externes d'inspection, de la présence et de l'utilisation de ces produits sur les lieux des travaux.
 - .5 Le contremaître ou le surveillant des travaux doit pouvoir démontrer au représentant ministériel qu'il a reçu une formation portant sur le SIMDUT et qu'il est au courant des exigences de ce système. Le représentant ministériel peut exiger le remplacement de cette personne, si celle-ci ne satisfait pas à l'exigence susmentionnée ou si le SIMDUT n'est pas mis en œuvre de façon acceptable.

4. GÉNÉRALITÉS

- .1 Sans objet en français.

5. ACHÈVEMENT DES TRAVAUX

- .1 Terminer tous les travaux dans les 16 semaine(s) qui suivent la réception de l'avis d'acceptation de la soumission. A noter qu'une partie des travaux devront être terminés au 30 octobre 2015

6. VENTILATION DES COÛTS

- .1 Avant de demander le premier paiement d'acompte, soumettre à l'approbation du représentant ministériel une ventilation des coûts.
- .2 Une fois approuvée, utiliser la ventilation des coûts comme base pour la soumission de toute autre demande.
- .3 Avant de rédiger et de soumettre une demande sous sa forme définitive, obtenir le consentement verbal du représentant ministériel quant au montant de cette demande.

7. MATÉRIAUX ET MISE EN ŒUVRE

- .1 Pour le présent projet, n'utiliser que des matériaux neufs, sauf si noté autrement.
- .2 Seuls les travaux de première classe seront acceptés, non seulement en ce qui a trait à la sécurité, l'efficacité et la durabilité, mais aussi à l'exactitude du détail et au bon rendement.

8. SOUS-TRAITANTS

- .1 Dans les 72 heures qui suivent l'acceptation de la soumission, soumettre à l'étude du représentant ministériel une liste complète des sous-traitants.

9. VISITE DU CHANTIER

- .1 Aux fins de la soumission, la visite au chantier doit être effectuée en présence du représentant ministériel.

10. NORMES MINIMALES

- .1 Se conformer aux exigences des normes minimales acceptables des divers codes fédéraux, provinciaux et municipaux pertinents tels le Code national du bâtiment, le Code national de prévention des incendies, le Code canadien de la plomberie, le Code canadien de l'électricité, le Code canadien de la sécurité sur les chantiers de construction et la Loi provinciale sur la sécurité dans la construction, ou les dépasser.
- .2 Effectuer les travaux conformément aux normes et codes dont il est fait mention, en vigueur ou révisés à la date de publication du présent devis.

11. SÉCURITÉ INCENDIE ET SÉCURITÉ GÉNÉRALE

- .1 Se conformer aux exigences des normes no. 301 et 302 émises par le Commissaire des incendies du Canada.
- .2 Se conformer aux exigences de l'Agent de prévention des incendies du Conseil national de recherches ainsi qu'à celles annoncées dans la section 01545.
- .3 Se conformer aux instructions portant sur la sécurité provenant du représentant ministériel ou de l'Agent de prévention des incendies du Conseil national de recherches.
- .4 Se conformer au Code national du bâtiment (Partie 8, Mesures de sécurité sur les chantiers de construction), ainsi qu'à la loi provinciale sur la sécurité dans la construction.

12. MESURES DE PROTECTION ET ÉCRITEAUX AVERTISSEMENT

- .1 Fournir et installer tous les matériaux nécessaires pour protéger le matériel existant.
- .2 Ériger des écrans anti-poussière pour éviter que la poussière et les débris ne se répandent en dehors des limites des travaux.
- .3 Protéger contre la poussière le matériel et le mobilier avec des bâches et coller ces dernières au plancher, au moyen de ruban adhésif, pour que la poussière ne s'infilte pas.
- .4 Réparer ou remplacer, gratuitement et à la satisfaction du représentant ministériel, tout bien du Propriétaire endommagé pendant les travaux.
- .5 Protéger les édifices, les routes, les pelouses, les services, etc. contre tout dommage qui pourrait survenir suite à l'exécution des présents travaux.
- .6 Planifier et coordonner les travaux pour que l'eau, la poussière, etc. ne s'infilte pas dans les édifices.
- .7 Fermer toutes les portes, fenêtres, etc. qui pourraient permettre le passage de la poussière, de vapeurs, etc. dans les autres secteurs de l'édifice.
- .8 Fermer le secteur des travaux à la fin de chaque journée de travail et être responsable des lieux.
- .9 Fournir et installer en permanence des barrières de sécurité appropriées autour du chantier pour éviter que le public et le personnel du CNRC soient blessés pendant l'exécution des travaux.
- .10 Poser des écriteaux d'avertissement pour toutes les situations où il pourrait se produire des blessures (ex : Casque protecteurs obligatoires, danger, travaux, etc.) ou lorsque le représentant ministériel le demande.
- .11 Fournir et installer des abris provisoires au-dessus des entrées et des sorties de l'édifice pour assurer la protection des piétons. Tous ces abris doivent pouvoir résister aux intempéries et à la chute de débris.

13. DISPOSITIFS DE FIXATION

- .1 Sauf autorisation expresse du représentant ministériel, il est interdit d'utiliser des pistolets à charge explosive.
- .2 Se conformer aux exigences de la norme ACNOR A-166, Pistolets d'ancrage à charge explosive.

- .3 Obtenir la permission du représentant ministériel avant d'utiliser tout genre d'outils percussion.

14. BILINGUISME

- .1 Tous les écriteaux, avis, etc. doivent être bilingues.
- .2 Toute identification de services exigée aux termes du présent contrat.

15. CHAUFFAGE PROVISOIRE ET VENTILATION

- .1 Assumer les frais de la ventilation et du chauffage provisoire utilisés pendant la construction, y compris les frais d'installation, de combustible, d'exploitation, d'entretien et d'enlèvement du matériel.
- .2 Sauf si le représentant ministériel l'a autorisé, il est interdit d'utiliser des appareils de chauffage autonomes répandant des émanations dans les zones de travail.
- .3 Fournir et installer le matériel provisoire de chauffage et de ventilation requis dans les endroits fermés afin de:
 - .1 faciliter l'exécution des travaux.
 - .2 protéger les ouvrages et les matériaux contre l'humidité et le froid.
 - .3 réduire la condensation de l'humidité sur les surfaces à un niveau acceptable.
 - .4 assurer les niveaux de température ambiante et d'humidité indispensables pour l'entreposage, l'installation et la période de séchage requis des matériaux.
 - .5 assurer une ventilation adéquate afin de répondre aux exigences de santé publique concernant la sécurité dans les zones de travail.
- .4 Maintenir une température d'au moins 10o C (50oF) aux endroits spécifiés, partir du début des travaux de finition jusqu'au moment de l'acceptation du bâtiment par le représentant ministériel.
 - .1 Maintenir la température ambiante et l'humidité aux niveaux nécessaires pour assurer le bien être du personnel du CNRC.
- .5 Prendre les mesures nécessaires pour empêcher les accumulations dangereuses de poussières, fumées, buées, vapeurs et émanations, dans les zones occupées pendant les travaux de construction, y compris aussi les aires d'entreposage et les installations sanitaires.
 - .1 Évacuer les substances dangereuses de sorte que la santé des occupants ne soit pas mise en danger.
- .6 Assurer une surveillance constante et rigoureuse du fonctionnement du matériel de chauffage et de ventilation.
 - .1 Faire respecter les normes et les codes pertinents.
 - .2 Se conformer aux instructions de l'Agent de prévention des incendies du CNRC, ce qui comprend la désignation, sur demande, de gardiens de sécurité- incendie à temps complet.
 - .3 Faire respecter les normes de sécurité.
 - .4 Doter les appareils de combustion autonomes de mises à l'air libre vers l'extérieur.

- .5 Les installations et le matériel neufs ou existants ne pourront être utilisés pour le chauffage et la ventilation provisoire

16. ÉCARTS ET INTERFÉRENCES

- .1 Avant la fermeture de la soumission, examiner les dessins et le devis. Signaler aussitôt au représentant ministériel tout écart, défaut, omission ou interférence qui touchent les travaux.
- .2 Les articles mentionnés dans les dessins et/ ou le devis doivent être fournis et installés.
- .3 Si, au cours des travaux, l'Entrepreneur trouve que les plans ne reflètent pas la réalité, il lui incombe de le signaler immédiatement par écrit au représentant ministériel, lequel doit rapidement vérifier les allégations.
- .4 Tout travail exécuté après cette découverte, jusqu'à ce qu'il soit autorisé, doit être fait aux risques de l'Entrepreneur.
- .5 Si des obstacles spéciaux sont décelés en cours d'exécution et qu'ils n'avaient pas été signalés sur la soumission originale ou sur les plans et le devis, fournir et installer des doubles coudes ou des coudes ou modifier le tracé des services pour qu'il soit appropriés aux conditions du chantier, et ce sans frais supplémentaire.
- .6 Prendre les dispositions pour que tous les travaux ne gênent d'aucune façon l'exécution des autres travaux.
- .7 Le fait de commencer les travaux signifiera l'acceptation des conditions existantes.

17. COOPÉRATION

- .1 Coopérer avec le personnel du CNRC pour que les travaux de recherche courants soient interrompus le moins possible.
- .2 Faire, à l'avance, un calendrier de tous les travaux qui pourraient interrompre le travail normal exécuté dans l'édifice.
- .3 Faire approuver le calendrier par le représentant ministériel.
- .4 Donner un préavis écrit de 72 heures au représentant ministériel avant toute interruption projetée des installations, des secteurs, des corridors, des services mécaniques ou électriques, et attendre son autorisation.

18. EXAMEN GÉNÉRAL

- .1 Même si le représentant ministériel revoit périodiquement les travaux de l'Entrepreneur, ceci ne dégage pas l'Entrepreneur de sa responsabilité d'exécuter les travaux conformément aux documents contractuels. L'Entrepreneur doit effectuer son propre contrôle de la qualité pour vérifier si ses travaux sont conformes aux documents contractuels.

19. INSPECTION DES SERVICES ENFOUIS OU DISSIMULÉS

- .1 Avant de dissimuler tout service installé, s'assurer que tous les organismes d'inspection intéressés, y compris le CNRC, ont inspecté les ouvrages et ont assisté à tous les essais. Dans le cas contraire, l'Entrepreneur peut avoir à les découvrir à ses propres frais.

20. ESSAIS

- .1 A l'achèvement des travaux, ou sur demande du représentant ministériel et (ou) des inspecteurs des organismes locaux en cours d'exécution, et avant que tout service soit couverts et que le rinçage soit terminé, faire l'essai de toutes les installations en présence du représentant ministériel.
- .2 Obtenir tous les certificats d'acceptation ou tous les résultats d'essais des organismes compétents et les remettre le représentant ministériel. Dans le cas contraire, le projet ne sera pas complet.

21. HEURES DE TRAVAIL ET SÉCURITÉ

- .1 Les heures normales de travail au CNRC sont de 8h00 à 16h30, du lundi au vendredi inclusivement, sauf les congés fériés.
- .2 En tout autre temps, des laissez-passer spéciaux sont nécessaires pour avoir accès au chantier.
- .3 Obtenir la permission du représentant ministériel d'exécuter des tâches particulières avant de planifier tout travail après les heures normales de travail.
- .4 Après les heures normales de travail, il se peut qu'une escorte soit nécessaire. Défrayer les coûts de cette escorte si le représentant ministériel le demande.
- .5 Toute personne employée par l'entrepreneur, ou par quelque sous-traitants, et travaillant à pied d'œuvre, doit porter et garder visible les insignes d'identifications émises par le Bureau de sécurité du CNRC.

22. CALENDRIER DES TRAVAUX

- .1 L'Entrepreneur doit soumettre un calendrier détaillé des travaux, indiquant les dates du début et de la fin des diverses étapes des travaux et le mettre à jour. Il doit remettre ce calendrier au représentant ministériel au plus tard deux semaines après l'adjudication du contrat et avant d'entreprendre tout travail au chantier.
- .2 Informer le représentant ministériel par écrit de toute modification apportée au calendrier.
- .3 5 jour (s) avant la date d'achèvement prévue, planifier de faire une inspection provisoire avec le représentant ministériel.

23. INTERRUPTIONS DES SERVICES

- .1 Planifier toutes les interruptions de service avec le représentant ministériel. N'utiliser aucun matériel ou installation du CNRC.
- .2 Donner un préavis de 72 heures avant d'interrompre tout service.
- .3 La durée de toutes interruptions de service doit être réduite au minimum.
- .4 Protéger les services existants comme il se doit et effectuer aussitôt toutes les réparations nécessaires.
- .5 Afin de minimiser les interruptions, prévoir des déviations, des ponts, des sources d'alimentation de rechange, etc., au besoin.
- .6 Planifier les travaux à l'avance et les exécuter de façon à minimiser les dérangements et les interruptions de services.

24. DESSINS D'ATELIER

- .1 Soumettre au représentant ministériel, aux fins de vérification, les dessins d'atelier, la documentation et les échantillons prescrit 1 semaine(s) après l'adjudication du contrat.
- .2 Soumettre au représentant ministériel aux fins de vérification, une liste complète de tous les dessins d'atelier, la documentation et les échantillons prescrits et une confirmation écrite des dates de livraison correspondantes dans l'intérieur d'une (1) semaine, suite à la date d'approbation des dessins d'atelier, de la documentation et des échantillons. Cette liste devra être mise à jour sur une base de 1 semaine(s) et n'importe quels changements à la liste devront être immédiatement notifiés par écrit au représentant ministériel.
- .3 Examiner les dessins d'atelier, la documentation et les échantillons avant de les soumettre.
- .4 Sauf avis contraire, soumettre 5 copies de tous les dessins d'atelier, de la documentation, ainsi que des échantillons pour vérification.
- .5 Demeurer responsable des erreurs et des omissions apparaissant dans les dessins d'atelier et la documentation et s'assurer qu'ils sont conformes aux documents contractuels même s'ils sont revus par le représentant ministériel.

25. ÉCHANTILLONS ET MAQUETTES

- .1 Soumettre des échantillons aux dimensions et quantités prescrites.
- .2 Si la couleur, le motif ou la texture sont des facteurs spécifiés, soumettre tout un éventail d'échantillons.
- .3 Monter des modèles et des maquettes au chantier, aux endroits qui conviennent le représentant ministériel.
- .4 Tout travail terminé est vérifié sur place d'après les modèles ou maquettes approuvés qui servent de normes pour la façon et les matériaux.

26. INSTRUCTIONS DU FABRICANT

- .1 Sauf indications contraires, se conformer aux plus récentes instructions écrites du fabricant concernant les matériaux et le matériel à utiliser et les méthodes de mise en place.
- .2 Aviser le représentant ministériel par écrit de toute divergence entre le présent devis et les instructions du fabricant; le représentant ministériel déterminera alors quel document a priorité.

27. DEVIS DESCRIPTIF, BULLETINS, DESSINS D'ARCHIVES

- .1 L'Entrepreneur doit conserver à pied d'œuvre une (1) copie à jour et en bon état de tous les devis, dessins et bulletins relatifs aux travaux; le représentant ministériel ou ses représentants doivent pouvoir les consulter en tout temps.
- .2 L'Entrepreneur doit annoter au moins une (1) copie du devis et des dessins pour y indiquer tous les travaux tels qu'ils ont été exécutés. Il doit la remettre au représentant ministériel avec la Demande de paiement pour le Certificat définitif d'achèvement des travaux.

28. ACCEPTATION DU CHANTIER

- .1 Avant d'entreprendre les travaux, l'Entre-preneur doit visiter le chantier et, en compagnie du représentant ministériel, revoir toutes les conditions qui pourraient toucher ses travaux.
- .2 Le début des travaux signifiera l'acceptation des conditions existantes.

29. OCCUPATION PARTIELLE Y

- .1 Le CNRC peut demander une occupation partielle de l'installation si les travaux se poursuivent au-delà de la date d'achèvement prévue.

30. UTILISATION DU CHANTIER

- .1 Limiter les travaux sur le chantier aux secteurs approuvés par le représentant ministériel au moment de la soumission.
- .2 Tous matériel, structures, abris, etc. provisoires doivent se trouver dans les secteurs désignés.
- .3 Limiter le stationnement aux secteurs désignés.
- .4 Ne pas limiter l'accès à l'édifice, routes et services.
- .5 Ne pas encombrer inutilement le chantier de matériaux ou de matériel.

31. VOILES D'ACCÈS

- .1 Prendre les dispositions nécessaires avec le représentant ministériel avant de commencer les travaux ou avant de transporter des matériaux et du matériel au chantier.
- .2 Obtenir l'approbation du représentant ministériel quant aux moyens d'accès normaux au chantier pendant la période de construction.
- .3 Obtenir l'approbation du représentant ministériel avant de suspendre temporairement les travaux sur le chantier; avant de retourner au chantier et avant de quitter le chantier à la fin des travaux.
- .4 Obtenir l'approbation du représentant ministériel avant de suspendre temporairement les travaux sur le chantier; avant de retourner au chantier et avant de quitter le chantier à la fin des travaux.
- .5 Aménager et entretenir des routes provisoires et assurer leur déneigement pendant les travaux.
- .6 L'Entrepreneur doit réparer et nettoyer les routes qu'il a dû utiliser au cours des travaux.

32. SURCHARGE

- .1 S'assurer qu'aucune partie de l'ouvrage ou de l'édifice ne supporte une charge susceptible de compromettre sa sécurité ou de causer une déformation permanente ou un dommage de structure.

33. SERVICES PROVISOIRES

- .1 L'Entrepreneur pourra bénéficier d'une source provisoire d'électricité à pied d'œuvre. Il devra fournir, sans frais, tous les raccords et matériaux nécessaires pour assurer ledit service au chantier.
- .2 Fournir et installer tous les centres de distributions, disjoncteurs, conduits, câblage, commutateur de déconnexion, transformateurs nécessaires à partir de la source d'électricité.
- .3 Il n'est permis d'utiliser le courant que pour les outils électriques, l'éclairage, les commandes, les moteurs, et non pas pour chauffer.
- .4 Sur demande, il sera possible de se raccorder provisoirement au réseau de distribution d'eau.
- .5 Assumer tous les frais pour amener l'eau aux endroits nécessaires.
- .6 Se conformer aux exigences du CNRC lors du raccordement aux réseaux existants, conformément aux articles "Coopération" et "Interruptions des services" de cette section".

34. BUREAU ET TÉLÉPHONE AU CHANTIER

- .1 L'Entrepreneur devra ériger, à ses frais, un bureau temporaire au chantier.
- .2 Au besoin, installer un téléphone et en assurer l'entretien.
- .3 Il est interdit d'utiliser les téléphones du CNRC, sauf en cas d'urgence.

35. INSTALLATIONS SANITAIRES

- .1 Si le représentant ministériel l'autorise, il est permis d'utiliser les installations sanitaires existantes.
- .2 Il incombe à l'Entrepreneur d'assurer la propreté de ces installations en tout temps.
- .3 Si l'Entrepreneur doit fournir ses propres installations, il doit en assumer tous les frais.

36. RÉUNIONS

- .1 Tenir régulièrement des réunions aux heures et aux endroits approuvés par le représentant ministériel.
- .2 Aviser toutes les parties intéressées des réunions pour assurer une bonne coordination des travaux.
- .3 Le représentant ministériel déterminera les heures de réunions et assume la responsabilité d'enregistrer et distribuer le procès verbal.

37. ENTREPOSAGE

- .1 Pour ne pas que les outils, matériaux, etc. soient endommagés ou volés, prévoir un entrepôt et en être responsable.
- .2 Il est interdit d'entreposer des produits inflammables ou explosifs sur le chantier à moins que l'Agent de prévention des incendies du CNRC l'autorise.

38. DRAINAGE

- .1 Assurer le drainage et le pompage temporaires, selon les besoins, afin de garder les excavations et le chantier propres.

39. ENCEINTES ET FERMETURES DE LA CHARPENTE

- .1 Ériger et entretenir toutes les enceintes temporaires nécessaires pour protéger les fondations, le sous-sol, le béton, la maçonnerie, etc. contre le gel ou les dommages.
- .2 Ne pas les enlever tant que tout danger de dommage n'est pas écarté et tant que la cure n'est pas terminée.
- .3 Munir les ouvertures extérieures de fermetures protectrices provisoires à l'épreuve des intempéries, jusqu'à ce que les châssis, les vitres et les portes extérieures soient installés en permanence.
- .4 Fournir et installer des fermetures avec verrou, afin d'assurer la sécurité des installations du CNRC, et en être responsable.
- .5 Sur demande, remettre des clés au personnel de sécurité du CNRC.

40. DISPOSITION DES OUVRAGES

- .1 Disposer les ouvrages avec soin et avec précision.
- .2 Vérifier toutes les dimensions et en être responsable.
- .3 Situer les points de repère généraux et prendre les mesures nécessaires pour empêcher leur déplacement.
- .4 Engager une personne compétente pour agencer les travaux selon les lignes et les niveaux de contrôle fournis par le représentant ministériel.

41. DISSIMULATION

- .1 Sauf indication contraire, dissimuler tous les services, tuyauterie, câblage, conduits, etc. dans les planchers, les murs ou les plafonds.

42. CONFLITS D'ESPACE DE TRAVAIL

- .1 Exécuter les travaux en gardant bien à l'esprit de ne pas entrer en conflit avec les autres gens de métier.
- .2 Pendant toute la durée des travaux, voir à toujours être au courant des conditions du chantier et des travaux exécutés par tous les autres gens de métier, engagés dans le présent projet.

43. DÉCOUPAGE ET RAPIÉÇAGE

- .1 Découper les surfaces existantes de façon à ce que les ouvrages s'agencent correctement entre eux.
- .2 Supprimer tous les articles indiqués ou prescrits.
- .3 Rapiécer et réparer, à la satisfaction du représentant ministériel, les surfaces qui ont été modifiées, découpées ou endommagées, avec des matériaux identiques.

- .4 Là où des nouveaux tuyaux passent à travers des travaux existants, percer une ouverture. La dimension de l'ouverture doit laisser un jeu de 12mm (1/2") autour des tuyaux ou de l'isolation de la tuyauterie. Ne pas percer, ni couper aucune surface sans l'approbation de le représentant ministériel.
- .5 Obtenir l'approbation écrite du représentant ministériel avant de percer des ouvertures dans les pièces de charpente neuves ou existantes.
- .6 Calfeutrer toutes les ouvertures où des câbles, conduits ou tuyaux passent à travers les murs avec un calfeutrant acoustique conforme à CAN/CGSB 19.21-M87.
- .7 Là où des câbles, conduits ou tuyaux passent à travers des murs ou des planchers coupe-feu, remplir l'espace avec des fibres de verre comprimées et calfeutrer avec un calfeutrant en accord avec CAN/CGSB-19.13 et NBC 3.1.7.

44. NETTOYAGE PENDANT LA CONSTRUCTION

- .1 Sur une base quotidienne, garder les lieux et le secteur adjacent au campus, y compris les toits, exempts de débris et de déchets.
- .2 Apporter sur les lieux des conteneurs destinés à la cueillette des déchets et des débris.

45. NETTOYAGE FINAL

- .1 A la fin des travaux, effectuer le nettoyage final à la satisfaction du représentant ministériel.
- .2 Nettoyer toutes les nouvelles surfaces, les luminaires et les surfaces existantes touchés par les présents travaux, remplacer les filtres, etc.
- .3 Nettoyer tous les couvre-planchers souples et les préparer à recevoir le fini protecteur qui sera appliqué par le personnel du CNRC.

46. ÉVACUATION DES DÉCHETS

- .1 Évacuer, en toute sécurité hors des terrains du CNRC, tous les déchets, y compris les produits volatils; voir article "Sécurité-incendie et "Sécurité générale", section 01000.

47. GARANTIE

- .1 Voir les conditions générales C, section GC32.
- .2 Veiller à ce que toutes les garanties soient adressées au nom de l'entrepreneur et du Conseil national de recherches du Canada.

48. MANUELS D'ENTRETIEN

- .1 À la fin des travaux et avant la décharge de garantie, soumettre trois (3) exemplaires bilingues des manuels d'entretien ou deux exemplaires de chacune des versions anglaises et françaises.
- .2 Bien relier les données dans des cahiers à couverture rigide pour feuilles volantes.
- .3 Les manuels doivent renfermer les instructions d'exploitation et d'entretien, les garanties, les dessins d'atelier, la documentation technique, etc. touchant les matériaux et les appareils fournis aux termes du présent contrat.

49. INSIGNES D'IDENTIFICATION

- .1 L'utilisation d'insignes d'identification est obligatoire dans les bâtiments du CNRC.
- .2 Obtenir toutes les insignes de la Bureau de la sécurité.

50. MATÉRIEL ET PRODUITS SPÉCIFIÉS, DÉSIGNÉS ACCEPTABLES OU SUBSTITUTS

- .1 Les produits et le matériel spécifiés dans les dessins ou les devis ont été sélectionnés dans le but d'établir des normes de rendement et de qualité. Dans la plupart des cas, lorsque l'on précise la marque de commerce et le numéro de modèle de tout produit ou matériel, on indique aussi les noms d'autres fabricants qui seraient acceptables. Les entrepreneurs peuvent calculer le montant de leur soumission en se fondant sur les prix des produits et du matériel fournis par n'importe quel des fabricants désignés comme étant des fournisseurs acceptables de produits ou de matériel particuliers.
- .2 En plus des fabricants spécifiés ou désignés comme étant acceptables, vous pouvez demander au représentant ministériel d'approuver d'autres fabricants, produits ou matériel. Pour faire approuver un produit en tant que substitut, vous devez remettre une demande par écrit au représentant ministériel au cours de la période fixée pour soumissionner, au plus tard sept (7) jours ouvrables avant la clôture de l'appel d'offres.
- .3 Vous devez attester par écrit que le substitut répond à toutes les exigences relatives aux dimensions, à la capacité, au rendement et à la qualité du matériel ou des produits spécifiés. En outre, il est entendu que l'entrepreneur assume tous les coûts qui sont reliés à l'acceptation des substituts proposés, ou qui en résultent.
- .4 L'approbation des substituts sera communiquée sous forme d'un Addendum aux documents de soumission.
- .5 Nous n'examinerons pas les demandes d'approbation d'autres fabricants, produits ou matériel qui sont incomplets et impossibles à évaluer ou qui sont soumises moins de sept (7) jours avant la clôture de l'appel d'offres.

51. DESSINS

- .1** Les dessins suivants illustrent les travaux exécutés et font partie du présent contrat.

FIN DE SECTION

1.1 AUTORITÉ

- .1 Le Commissaire des incendies du Canada (CIC) est l'autorité en matière de sécurité incendie au CNRC.
- .2 Aux fins du présent document, le représentant ministériel est le représentant de la CNRC en charge du projet.
- .3 Le représentant ministériel doit consulter l'agent de prévention des incendies (API) au besoin.
- .4 Le représentant ministériel doit mettre en application les présentes exigences de sécurité incendie.
- .5 Respectez les normes suivantes publiées par le Bureau du commissaire des incendies du Canada:
 - .1 Norme n301 'Norme Travaux de construction', juin 1982;
 - .2 Norme n302 'Norme Travaux de soudage et de coupage au chalumeau', juin 1982.

1.2 TRAVAIL À CHAUD

- .1 Permis:
 - .1 Vous devez obtenir un permis de 'Travail à chaud' du représentant ministériel avant d'entreprendre des travaux de soudage, de brasage, de brûlage ou d'utilisation de chalumeaux et de salamandres ou d'une flamme nue.
- .2 Examen du site:
 - .1 Avant le début du travail à chaud, réexaminez l'aire de travaux avec le représentant ministériel pour déterminer le niveau de sécurité incendie nécessaire.

1.3 SIGNALISATION DES INCENDIES

- .1 Soyez au courant de l'emplacement exact du téléphone et de l'alarme manuelle d'incendie les plus près, ainsi que le numéro de téléphone d'urgence.
- .2 SIGNALER immédiatement tout incident comportant un feu en procédant comme suit :
 - .1 Déclenchez l'alarme manuelle d'incendie le plus près;
 - .2 Téléphonnez au numéro de téléphone d'urgence suivant:

<u>CNRC LOCATION</u>	<u>CELLULAR OU NON-CNRC PHONES</u>	<u>CNRC PHONES</u>
Boucherville	1 450 641-5233	333

- .3 Lorsque vous signalez un incendie par téléphone, indiquez l'endroit exact du feu, le nom et le numéro du bâtiment, et soyez prêts à vérifier le lieu.
- .4 La personne qui déclenche l'alarme manuelle d'incendie doit demeurer sur la scène d'incendie pour fournir les renseignements et les indications nécessaires au personnel du service d'incendie.

1.4 RÉSEAUX DÉTECTEURS ET ALARMES D'INCENDIE À L'INTÉRIEUR ET À L'EXTÉRIEUR

- .1 N'OBSTRUEZ PAS ET NE FERMEZ PAS LES RÉSEAUX DÉTECTEURS ET ALARMES D'INCENDIE SANS L'AUTORISATION DU REPRÉSENTANT MINISTÉRIEL.
- .2 LORS D'UNE INTERRUPTION D'UN RÉSEAU AVERTISSEUR, DES MESURES SPÉCIALES DÉFINIES PAR LE REPRÉSENTANT MINISTÉRIEL DOIVENT ÊTRE PRISES POUR S'ASSURER QUE LA PROTECTION INCENDIE SOIT MAINTENUE.
- .3 NE LAISSEZ PAS LES RÉSEAUX DÉTECTEURS ET AVERTISSEURS D'INCENDIE INACTIFS A LA FIN D'UNE JOURNÉE DE TRAVAIL SANS AVOIR AVISÉ LE REPRÉSENTANT MINISTÉRIEL ET OBTENU SON AUTORISATION. LE REPRÉSENTANT MINISTÉRIEL DOIT INFORMER L'API DES DÉTAILS À CHAQUE OCCASION.
- .4 N'UTILISEZ PAS LES BORNES D'INCENDIE NI LES RÉSEAUX DE COLONNES MONTANTES ET ROBINETS ARMÉS À D'AUTRES FINS QUE LA LUTTE CONTRE L'INCENDIE SANS L'AUTORISATION DU REPRÉSENTANT MINISTÉRIEL.

1.5 EXTINCTEURS D'INCENDIES

- .1 Fournissez au moins un extincteur à poudre ABC (20 lb) pour chaque site de travail à chaud.
- .2 Fournissez les extincteurs suivants pour les travaux d'asphalte chaud et de toiture:
 - .1 Près du pot de goudron - 1 extincteur à poudre ABC (20 lb);
 - .2 Toiture - 2 extincteurs à poudre ABC (20 lb).
- .3 Prévoir des extincteurs munis:
 - .1 d'une goupille et d'un sceau;
 - .2 d'un manomètre;
 - .3 d'une étiquette portant la signature d'un préposé d'une compagnie d'entretien d'extincteurs d'incendie.
- .4 Les extincteurs à l'anhydride carbonique (CO) ne sont pas considérés comme des substituts des extincteurs ci-dessus.

1.6 TRAVAUX DE TOITURE

- .1 Chaudières:
 - .1 Prévoyez l'emplacement des chaudières d'asphalte et le lieu d'entreposage avec le représentant ministériel avant la livraison au chantier. N'installez pas les

- chaudières sur une toiture ou sur un échafaudage et placez-les à une distance d'au moins 10 m (30 pi) de tout bâtiment.
- .2 Les chaudières doivent être équipées de thermomètres ou de jauges en bon état de fonctionnement.
 - .3 N'utilisez pas les chaudières à des températures excédant 232C (450F).
 - .4 Assurez une surveillance permanente pendant l'usage des chaudières et fournissez des couvercles de métal pour étouffer les flammes en cas de feu dans les chaudières. Fournissez les extincteurs d'incendie exigés à l'article 5.1 (Extincteurs d'incendie).
 - .5 Expliquez les capacités des récipients au représentant ministériel avant le début des travaux.
 - .6 Ranger les bouteilles de gaz comprimé debout à une distance d'au moins 20 pieds de la chaudière.
 - .7 Ranger les matériaux à une distance d'au moins 20 pieds de la chaudière.
- .2 Balais à franges ('vadrouilles'):
- .1 N'utilisez que des balais à franges en fibres de verre pour toitures.
 - .2 Enlevez les balais à franges usagés du lieu de travail à la fin de chaque journée de travail.
- .3 Application au chalumeau:
- .1 N'UTILISEZ PAS DE CHALUMEAUX À PROXIMITÉ DES MURS.
 - .2 Assurez une surveillance incendie conformément à l'article 7 de la présente section.
- .4 Entreposage des matériaux:
- .1 Rangez tous les matériaux combustibles utilisés pour les toitures à une distance d'au moins 3 m (10 pi) de toute structure.
- .5 Bouteilles de gaz:
- .1 Les bouteilles de gaz doivent être protégées des dommages mécaniques et maintenues en position verticale.

1.7 SURVEILLANCE INCENDIE

- .1 Assurez une surveillance incendie pendant au moins une heure après la fin d'une journée de travail à chaud.
- .2 Chauffage provisoire : voir la Section 01000, Instructions générales.
- .3 Dotez les équipes de repérage des incendies des extincteurs prévus à l'article 5.

1.8 OBSTRUCTION DES VOIES D'ÉVACUATION DES CHAUSSÉES, DES COULOIRES, DES PORTES ET DES ASCENSEURS

- .1 Avisez le représentant ministériel avant d'entreprendre tout travail qui entraverait le libre passage du personnel du service d'incendie et de son équipement. Cela englobe toute dérogation à la hauteur libre minimale, à l'édification de barricades et au creusement de tranchées.

- .2 Les parcours d'issue du bâtiment ne doivent nullement être obstrués sans la permission expresse du représentant ministériel, qui s'assurera que des parcours de remplacement seront maintenus.
- .3 Le représentant ministériel avisera l'API de tout obstacle pouvant justifier une planification et des dispositifs de communication plus poussés pour assurer la sécurité des occupants et l'efficacité des interventions de lutte contre l'incendie.

1.9 USAGE DU TABAC

- .1 Il est interdit de fumer dans les immeubles du CNRC, sauf dans les fumoirs désignés.
- .2 Respectez les écriteaux "DÉFENSE DE FUMER".

1.10 DÉBRIS ET DÉCHETS

- .1 Limitez autant que possible les détritres et les déchets et les ranger à une distance d'au moins 20 pieds des chaudières ou des torches.
- .2 Il est interdit de faire brûler des détritres sur le chantier.
- .3 Enlèvement:
 - .1 Enlevez tous les détritres des lieux de travail à la fin de la journée de travail ou de l'équipe, ou selon les instructions reçues.
- .4 Stockage:
 - .1 Soyez extrêmement prudents lorsque vous devez stocker des déchets combustibles sur les lieux de travail. Maintenez les lieux le plus propre possible et bien ventilés et respectez les normes de sécurité.
 - .2 Déposez les torchons et autres matériaux graisseux ou huileux sujets à la combustion spontanée dans des contenants approuvés et évacuez-les comme exigé au paragraphe 3.1.
- .5 Bennes à déchets:
 - .1 En consultation avec le représentant ministériel, déterminez un emplacement sûr et acceptable avant de livrer la benne au chantier.

1.11 LIQUIDES INFLAMMABLES

- .1 La manutention, le stockage et l'utilisation de liquides inflammables sont régis par le no 101 du CIC et par le Code national de prévention des incendies du Canada en vigueur.
- .2 Les liquides inflammables comme l'essence, le kérosène et le naphtha, peuvent être gardés sur les lieux pour fins d'usage à brève échéance en quantités ne dépassant pas 45 litres, à condition d'être stockés dans les bidons de sûreté portant le sceau d'approbation des LAC (ULC). Le stockage de plus grandes quantités de liquides inflammables aux fins de l'exécution des travaux qui nécessite l'autorisation du représentant ministériel.
- .3 Il est interdit de transvaser des liquides inflammables à l'intérieur des bâtiments.
- .4 Il est interdit de transvaser des liquides inflammables à proximité de dispositifs à flamme nue ou de tout autre type de dispositif dégageant de la chaleur.
- .5 Il est interdit d'utiliser des liquides inflammables ayant un point d'éclair inférieur à 38C (100F, tels que le naphtha ou l'essence, comme solvants ou agents de nettoyage.

- .6 Stockez les liquides résiduels inflammables dans des récipients approuvés situés dans un endroit sûr bien ventilé. Les déchets constitués de liquides inflammables doivent être régulièrement évacués du chantier.
- .7 Lorsque des liquides inflammables, tels que des lacques ou des uréthanes, sont utilisés, veillez à ce que la ventilation soit adéquate et éliminer toute source d'inflammation. Prévenez le représentant ministériel avant le début de tels travaux et une fois les travaux achevés.

1.12 QUESTIONS ET/OU DEMANDES D'EXPLICATIONS

- .1 Adressez vos questions ou demandes d'explications concernant la sécurité incendie au représentant ministériel.

FIN DE SECTION



TP1 Amount Payable – General

1.1 Subject to any other provisions of the contract, Her Majesty shall pay the Contractor, at the times and in the manner hereinafter set out, the amount by which

1.1.1 the aggregate of the amounts described in TP2 exceeds

1.1.2 the aggregate of the amounts described in TP3

and the Contractor shall accept that amount as payment in full satisfaction for everything furnished and done by him in respect of the work to which the payment relates.

TP2 Amounts Payable to the Contractor

2.1 The amounts referred to in TP1.1.1 are the aggregate of

2.1.1 the amounts referred to in the Articles of Agreement, and

2.1.2 the amounts, if any, that are payable to the Contractor pursuant to the General Conditions.

TP3 Amounts Payable to Her Majesty

3.1 The amounts referred to in TP1.1.2 are the aggregate of the amounts, in any, that the Contractor is liable to pay Her Majesty pursuant to the contract.

3.2 When making any payments to the Contractor, the failure of Her Majesty to deduct an amount referred to in TP3.1 from an amount referred to in TP2 shall not constitute a waiver of the right to do so, or an admission of lack of entitlement to do so in any subsequent payment to the Contractor.

TP4 Time of Payment

4.1 In these Terms of Payment

4.1.1 The “payment period” means a period of 30 consecutive days or such other longer period as is agreed between the Contractor and the Departmental Representative.

4.1.2 An amount is “due and payable” when it is due and payable by Her Majesty to the Contractor according to TP4.4, TP4.7 or TP4.10.

4.1.3 An amount is overdue when it is unpaid on the first day following the day upon which it is due and payable.

4.1.4 The “date of payment” means the date of the negotiable instrument of an amount due and payable by the Receiver General for Canada and given for payment.

4.1.5 The “Bank Rate” means the discount rate of interest set by the Bank of Canada in effect at the opening of business on the date of payment.



- 4.2 The Contractor shall, on the expiration of a payment period, deliver to the Departmental Representative in respect of that payment period a written progress claim that fully describes any part of the work that has been completed, and any material that was delivered to the work site but not incorporated into the work during that payment period.
- 4.3 The Departmental Representative shall, not later than ten days after receipt by him of a progress claim referred to in TP4.2,
- 4.3.1 inspect the part of the work and the material described in the progress claim; and
- 4.3.2 issue a progress report, a copy of which the Departmental Representative will give to the Contractor, that indicates the value of the part of the work and the material described in the progress claim that, in the opinion of the Departmental Representative,
- 4.3.2.1 is in accordance with the contract, and
- 4.3.2.2 was not included in any other progress report relating to the contract.
- 4.4 Subject to TP1 and TP4.5 Her Majesty shall, not later than 30 days after receipt by the Departmental Representative of a progress claim referred to in TP4.2, pay the Contractor
- 4.4.1 an amount that is equal to 95% of the value that is indicated in the progress report referred to in TP4.3.2 if a labour and material payment bond has been furnished by the Contractor, or
- 4.4.2 an amount that is equal to 90% of the value that is indicated in the progress report referred to in TP4.3.2 if a labour and material payment bond has not been furnished by the Contractor.
- 4.5 It is a condition precedent to Her Majesty's obligation under TP4.4 that the Contractor has made and delivered to the Departmental Representative,
- 4.5.1 a statutory declaration described in TP4.6 in respect of a progress claim referred to in TP4.2,
- 4.5.2 in the case of the Contractor's first progress claim, a construction schedule in accordance with the relevant sections of the Specifications, and
- 4.5.3 if the requirement for a schedule is specified, an update of the said schedule at the times identified in the relevant sections of the Specifications.
- 4.6 A statutory declaration referred to in TP4.5 shall contain a deposition by the Contractor that
- 4.6.1 up to the date of the Contractor's progress claim, the Contractor has complied with all his lawful obligations with respect to the Labour Conditions; and
- 4.6.2 up to the date of the Contractor's immediately preceding progress claim, all lawful obligations of the Contractor to subcontractors and suppliers of material in respect of the



work under the contract have been fully discharged.

- 4.7 Subject to TP1 and TP4.8, Her Majesty shall, not later than 30 days after the date of issue of an Interim Certificate of Completion referred to in GC44.2, pay the Contractor the amount referred to in TP1 less the aggregate of
- 4.7.1 the sum of all payments that were made pursuant to TP4.4;
 - 4.7.2 an amount that is equal to the Departmental Representative's estimate of the cost to Her Majesty or rectifying defects described in the Interim Certificate of Completion; and
 - 4.7.3 an amount that is equal to the Departmental Representative's estimate of the cost to Her Majesty of completing the parts of the work described in the Interim Certificate of Completion other than the defects referred to in TP4.7.2.
- 4.8 It is a condition precedent to Her Majesty's obligation under TP4.7 that the Contractor has made and delivered to the Departmental Representative,
- 4.8.1 a statutory declaration described in TP4.9 in respect of an Interim Certificate of Completion referred to in GC44.2, and
 - 4.8.2 if so specified in the relevant sections of the Specifications, and update of the construction schedule referred to in TP4.5.2 and the updated schedule shall, in addition to the specified requirements, clearly show a detailed timetable that is acceptable to the Departmental Representative for the completion of any unfinished work and the correction of all defects.
- 4.9 A statutory declaration referred to in TP4.8 shall contain a deposition by the contractor that up to the date of the Interim Certificate of Completion the Contractor has
- 4.9.1 complied with all of the Contractor's lawful obligations with respect to the Labour Conditions;
 - 4.9.2 discharged all of the Contractor's lawful obligations to the subcontractors and suppliers of material in respect of the work under the contract; and
 - 4.9.3 discharged the Contractor's lawful obligations referred to in GC14.6.
- 4.10 Subject to TP1 and TP4.11, Her Majesty shall, not later than 60 days after the date of issue of a Final Certificate of Completion referred to in GC44.1, pay the Contractor the amount referred to in TP1 less the aggregate of
- 4.10.1 the sum of all payments that were made pursuant to TP4.4; and
 - 4.10.2 the sum of all payments that were made pursuant to TP4.7.
- 4.11 It is a condition precedent to Her Majesty's obligation under TP4.10 that the Contractor has made and delivered a statutory declaration described in TP4.12 to the Departmental Representative.



- 4.12 A statutory declaration referred to in TP4.11 shall, in addition to the depositions described in TP4.9, contain a deposition by the Contractor that all of the Contractor's lawful obligations and any lawful claims against the Contractor that arose out of the performance of the contract have been discharged and satisfied.

TP5 Progress Report and Payment Thereunder Not Binding on Her Majesty

- 5.1 Neither a progress report referred to in TP4.3 nor any payment made by Her Majesty pursuant to these Terms of Payment shall be construed as an admission by Her Majesty that the work, material or any part thereof is complete, is satisfactory or is in accordance with the contract.

TP6 Delay in Making Payment

- 6.1 Notwithstanding GC7 any delay by Her Majesty in making any payment when it is due pursuant to these Terms of Payment shall not be a breach of the contract by Her Majesty.

- 6.2 Her Majesty shall pay, without demand from the Contractor, simple interest at the Bank Rate plus 1 -1/4 per centum on any amount which is overdue pursuant to TP4.1.3, and the interest shall apply from and include the day such amount became overdue until the day prior to the date of payment except that

- 6.2.1 interest shall not be payable or paid unless the amount referred to in TP6.2 has been overdue for more than 15 days following

6.2.1.1 the date the said amount became due and payable, or

6.2.1.2 the receipt by the Departmental Representative of the Statutory Declaration referred to in TP4.5, TP4.8 or TP4.11,

whichever is the later, and

- 6.6.2 interest shall not be payable or paid on overdue advance payments if any.

TP7 Right of Set-off

- 7.1 Without limiting any right of set-off or deduction given or implied by law or elsewhere in the contract, Her Majesty may set off any amount payable to Her Majesty by the Contractor under this contract or under any current contract against any amount payable to the Contractor under this contract.

- 7.2 For the purposes of TP7.1, "current contract" means a contract between Her Majesty and the Contractor

7.2.1 under which the Contractor has an undischarged obligation to perform or supply work, labour or material, or

7.2.2 in respect of which Her Majesty has, since the date of which the Articles of Agreement were made, exercised any right to take the work that is the subject of the contract out of the Contractor's hands.



TP8 Payment in Event of Termination

- 8.1 If the contract is terminated pursuant to GC41, Her Majesty shall pay the Contractor any amount that is lawfully due and payable to the Contractor as soon as is practicable under the circumstances.

TP9 Interest on Settled Claims

- 9.1 Her Majesty shall pay to the Contractor simple interest on the amount of a settled claim at an average Bank Rate plus 1 ¼ per centum from the date the settled claim was outstanding until the day prior to the date of payment.
- 9.2 For the purposes of TP9.1,
- 9.2.1 a claim is deemed to have been settled when an agreement in writing is signed by the Departmental Representative and the Contractor setting out the amount of the claim to be paid by Her Majesty and the items or work for which the said amount is to be paid.
- 9.2.2 an "average Bank Rate" means the discount rate of interest set by the Bank of Canada in effect at the end of each calendar month averaged over the period the settled claim was outstanding.
- 9.2.3 a settled claim is deemed to be outstanding from the day immediately following the date the said claim would have been due and payable under the contract had it not been disputed.
- 9.3 For the purposes of TP9 a claim means a disputed amount subject to negotiation between Her Majesty and the Contractor under the contract.



Section	Page	Heading
GC1	1	Interpretation
GC2	2	Successors and Assigns
GC3	2	Assignment of Contract
GC4	2	Subcontracting by Contractor
GC5	2	Amendments
GC6	3	No Implied Obligations
GC7	3	Time of Essence
GC8	3	Indemnification by Contractor
GC9	3	Indemnification by Her Majesty
GC10	3	Members of House of Commons Not to Benefit
GC11	4	Notices
GC12	4	Material, Plant and Real Property Supplied by Her Majesty
GC13	5	Material, Plant and Real Property Become Property of Her Majesty
GC14	5	Permits and Taxes Payable
GC15	6	Performance of Work under Direction of Departmental Representative
GC16	6	Cooperation with Other Contractors
GC17	7	Examination of Work
GC18	7	Clearing of Site
GC19	7	Contractor's Superintendent
GC20	8	National Security
GC21	8	Unsuitable Workers
GC22	8	Increased or Decreased Costs
GC23	9	Canadian Labour and Material
GC24	9	Protection of Work and Documents
GC25	10	Public Ceremonies and Signs
GC26	10	Precautions against Damage, Infringement of Rights, Fire, and Other Hazards
GC27	11	Insurance
GC28	11	Insurance Proceeds
GC29	12	Contract Security
GC30	12	Changes in the Work
GC31	13	Interpretation of Contract by Departmental Representative
GC32	14	Warranty and Rectification of Defects in Work
GC33	14	Non-Compliance by Contractor
GC34	14	Protesting Departmental Representative's Decisions
GC35	15	Changes in Soil Conditions and Neglect or Delay by Her Majesty
GC36	16	Extension of Time
GC37	16	Assessments and Damages for Late Completion
GC38	17	Taking the Work Out of the Contractor's Hands
GC39	18	Effect of Taking the Work Out of the Contractor's Hands
GC40	18	Suspension of Work by Minister
GC41	19	Termination of Contract
GC42	19	Claims Against and Obligations of the Contractor or Subcontractor
GC43	21	Security Deposit – Forfeiture or Return
GC44	22	Departmental Representative's Certificates
GC45	23	Return of Security Deposit
GC46	24	Clarification of Terms in GC47 to GC50
GC47	24	Additions or Amendments to Unit Price Table
GC48	24	Determination of Cost – Unit Price Table
GC49	25	Determination of Cost – Negotiation
GC50	25	Determination of Cost – Failing Negotiation
GC51	26	Records to be kept by Contractor
GC52	27	Conflict of Interest
GC53	27	Contractor Status



GC1 Interpretation

1.1 In the contract

- 1.1.1 where reference is made to a part of the contract by means of numbers preceded by letters, the reference shall be construed to be a reference to the particular part of the contract that is identified by that combination of letters and numbers and to any other part of the contract referred to therein;
- 1.1.2 “contract” means the contract document referred to in the Articles of Agreement;
- 1.1.3 “contract security” means any security given by the Contractor to Her Majesty in accordance with the contract;
- 1.1.4 “Departmental Representative” means the officer or employee of Her Majesty who is designated pursuant to the Articles of Agreement and includes a person specially authorized by him to perform, on his behalf, any of his functions under the contract and is so designated in writing to the Contractor;
- 1.1.5 “material” includes all commodities, articles and things required to be furnished by or for the Contractor under the contract for incorporation into the work;
- 1.1.6 “Minister” includes a person acting for, or if the office is vacant, in place of the Minister and his successors in the office, and his or their lawful deputy and any of his or their representatives appointed for the purposes of the contract;
- 1.1.7 “person” includes, unless the context otherwise requires, a partnership, proprietorship, firm, joint venture, consortium and a corporation;
- 1.1.8 “plant” includes all animals, tools, implements, machinery, vehicles, buildings, structures, equipment and commodities, articles and things other than material, that are necessary for the due performance of the contract;
- 1.1.9 “subcontractor” means a person to whom the Contractor has, subject to GC4, subcontracted the whole or any part of the work;
- 1.1.10 “superintendent” means the employee of the Contractor who is designated by the Contractor to act pursuant to GC19;
- 1.1.11 “work includes, subject only to any express stipulation in the contract to the contrary, everything that is necessary to be done, furnished or delivered by the Contractor to perform the contract.

1.2 The headings in the contract documents, other than in the Plans and Specifications, form no part of the contract but are inserted for convenience of reference only.

1.3 In interpreting the contract, in the event of discrepancies or conflicts between anything in the Plans and Specifications and the General Conditions, the General Conditions govern.



- 1.4 In interpreting the Plans and Specifications, in the event of discrepancies or conflicts between
- 1.4.1 the Plans and Specifications, the Specifications govern;
 - 1.4.2 the Plans, the Plans drawn with the largest scale govern; and
 - 1.4.3 figured dimensions and scaled dimensions, the figured dimensions govern.

GC2 Successors and Assigns

- 2.1 The contract shall inure to the benefit of and be binding upon the parties hereto and their lawful heirs, executors, administrators, successors and assigns.

GC3 Assignment of Contract

- 3.1 The contract may not be assigned by the Contractor, either in whole or in part, without the written consent of the Minister.

GC4 Subcontracting by Contractor

- 4.1 Subject to this General Condition, the Contractor may subcontract any part of the work.
- 4.2 The Contractor shall notify the Departmental Representative in writing of his intention to subcontract.
- 4.3 A notification referred to in GC4.2 shall identify the part of the work, and the subcontractor with whom it is intended to subcontract.
- 4.4 The Departmental Representative may object to the intended subcontracting by notifying the Contractor in writing within six days of receipt by the Departmental Representative of a notification referred to in GC4.2.
- 4.5 If the Departmental Representative objects to a subcontracting pursuant to GC4.4, the Contractor shall not enter into the intended subcontract.
- 4.6 The contractor shall not, without the written consent of the Departmental Representative, change a subcontractor who has been engaged by him in accordance with this General Condition.
- 4.7 Every subcontract entered into by the Contractor shall adopt all of the terms and conditions of this contract that are of general application.
- 4.8 Neither a subcontracting nor the Departmental Representative's consent to a subcontracting by the Contractor shall be construed to relieve the Contractor from any obligation under the contract or to impose any liability upon Her Majesty.

GC5 Amendments



- 5.1 No amendment or change in any of the provisions of the contract shall have any force or effect until it is reduced to writing.

GC6 No Implied Obligations

- 6.1 No implied terms or obligations of any kind by or on behalf of Her Majesty shall arise from anything in the contract and the express covenants and agreements therein contained and made by Her Majesty are the only covenants and agreements upon which any rights against Her Majesty are to be founded.
- 6.2 The contract supersedes all communications, negotiations and agreements, either written or oral, relating to the work that were made prior to the date of the contract.

GC7 Time of Essence

- 7.1 Time is of the essence of the contract.

GC8 Indemnification by Contractor

- 8.1 The Contractor shall indemnify and save Her Majesty harmless from and against all claims, demand, losses, costs, damages, actions, suits, or proceedings by whomever made, brought or prosecuted and in any manner based upon, arising out of, related to, occasioned by or attributable to the activities of the Contractor, his servants, agents, subcontractors and sub-subcontractors in performing the work including an infringement or an alleged infringement of a patent of invention or any other kind of intellectual property.
- 8.2 For the purpose of GC8.1, "activities" includes any act improperly carried out, any omission to carry out an act and any delay in carrying out an act.

GC9 Indemnification by Her Majesty

- 9.1 Her Majesty shall, subject to the Crown Liability Act, the Patent Act, and any other law that affects Her Majesty's rights, powers, privileges or obligations, indemnify and save the Contractor harmless from and against all claims, demands, losses, costs, damage, actions, suits or proceedings arising out of his activities under the contract that are directly attributable to
- 9.1.1 lack of or a defect in Her Majesty's title to the work site whether real or alleged; or
- 9.1.2 an infringement or an alleged infringement by the Contractor of any patent of invention or any other kind of intellectual property occurring while the Contractor was performing any act for the purposes of the contract employing a model, plan or design or any other thing related to the work that was supplied by Her Majesty to the Contractor.

GC10 Members of House of Commons Not to Benefit



- 10.1 As required by the Parliament of Canada Act, it is an express condition of the contract that no member of the House of Commons shall be admitted to any share of part of the contract or to any benefit arising therefrom.

GC11 Notices

- 11.1 Any notice, consent, order, decision, direction or other communication, other than a notice referred to in GC11.4, that may be given to the Contractor pursuant to the contract may be given in any manner.
- 11.2 Any notice, consent, order, decision, direction or other communication required to be given in writing, to any party pursuant to the contract shall, subject to GC11.4, be deemed to have been effectively given
- 11.2.1 to the Contractor, if delivered personally to the Contractor or the Contractor's superintendent, or forwarded by mail, telex or facsimile to the Contractor at the address set out in A4.1, or
- 11.2.2 to Her Majesty, if delivered personally to the Departmental Representative, or forwarded by mail, telex or facsimile to the Departmental Representative at the address set out in A1.2.1.
- 11.3 Any such notice, consent, order, decision, direction or other communication given in accordance with GC11.2 shall be deemed to have been received by either party
- 11.3.1 if delivered personally, on the day that it was delivered,
- 11.3.2 if forwarded by mail, on the earlier of the day it was received and the sixth day after it was mailed, and
- 11.3.3 if forwarded by telex or facsimile, 24 hours after it was transmitted.
- 11.4 A notice given under GC38.1.1, GC40 and GC41, if delivered personally, shall be delivered to the Contractor if the Contractor is doing business as sole proprietor or, if the Contractor is a partnership or corporation, to an officer thereof.

GC12 Material, Plant and Real Property Supplied by Her Majesty

- 12.1 Subject to GC12.2, the Contractor is liable to Her Majesty for any loss of or damage to material, plant or real property that is supplied or placed in the care, custody and control of the Contractor by Her Majesty for use in connection with the contract, whether or not that loss or damage is attributable to causes beyond the Contractor's control.
- 12.2 The Contractor is not liable to Her Majesty for any loss or damage to material, plant or real property referred to in GC12.1 if that loss or damage results from and is directly attributable to reasonable wear and tear.
- 12.3 The Contractor shall not use any material, plant or real property referred to in GC12.1 except for



the purpose of performing this contract.

- 12.4 When the Contractor fails to make good any loss or damage for which he is liable under GC12.1 within a reasonable time after being required to do so by the Departmental Representative, the Departmental Representative may cause the loss or damage to be made good at the Contractor's expense, and the Contractor shall thereupon be liable to Her Majesty for the cost thereof and shall, on demand, pay to Her Majesty an amount equal to that cost.
- 12.5 The Contractor shall keep such records of all material, plant and real property referred to in GC12.1 as the Departmental Representative from time to time requires and shall satisfy the Departmental Representative, when requested, that such material, plant and real property are at the place and in the condition which they ought to be.

GC13 Material, Plant and Real Property Become Property of Her Majesty

- 13.1 Subject to GC14.7 all material and plant and the interest of the Contractor in all real property, licenses, powers and privileges purchased, used or consumed by the Contractor for the contract shall, after the time of their purchase, use or consumption be the property of Her Majesty for the purposes of the work and they shall continue to be the property of Her Majesty.
- 13.1.1 in the case of material, until the Departmental Representative indicates that he is satisfied that it will not be required for the work, and
- 13.1.2 in the case of plant, real property, licenses, powers and privileges, until the Departmental Representative indicates that he is satisfied that the interest vested in Her Majesty therein is no longer required for the purposes of the work.
- 13.2 Material or plant that is the property of Her Majesty by virtue of GC13.1 shall not be taken away from the work site or used or disposed of except for the purposes of the work without the written consent of the Departmental Representative.
- 13.3 Her Majesty is not liable for loss of or damage from any cause to the material or plant referred to in GC13.1 and the Contractor is liable for such loss or damage notwithstanding that the material or plant is the property of Her Majesty.

GC14 Permits and Taxes Payable

- 14.1 The Contractor shall, within 30 days after the date of the contract, tender to a municipal authority an amount equal to all fees and charges that would be lawfully payable to that municipal authority in respect of building permits as if the work were being performed for a person other than Her Majesty.
- 14.2 Within 10 days of making a tender pursuant to GC14.1, the Contractor shall notify the Departmental Representative of his action and of the amount tendered and whether or not the municipal authority has accepted that amount.
- 14.3 If the municipal authority does not accept the amount tendered pursuant to GC14.1 the Contractor shall pay that amount to Her Majesty within 6 days after the time stipulated in GC14.2.



- 14.4 For the purposes of GC14.1 to GC14.3 “municipal authority” means any authority that would have jurisdiction respecting permission to perform the work if the owner were not Her Majesty.
- 14.5 Notwithstanding the residency of the Contractor, the Contractor shall pay any applicable tax arising from or related to the performance of the work under the contract.
- 14.6 In accordance with the Statutory Declaration referred to in TP4.9, a Contractor who has neither residence nor place of business in the province in which work under the contract is being performed shall provide Her Majesty with proof of registration with the provincial sales tax authorities in the said province.
- 14.7 For the purpose of the payment of any applicable tax or the furnishing of security for the payment of any applicable tax arising from or related to the performance of the work under the contract, the Contractor shall, notwithstanding the fact that all material, plant and interest of the Contractor in all real property, licenses, powers and privileges, have become the property of Her Majesty after the time of purchase, be liable, as a user or consumer, for the payment or for the furnishing of security for the payment of any applicable tax payable, at the time of the use or consumption of that material, plant or interest of the Contractor in accordance with the relevant legislation.

GC15 Performance of Work under Direction of Departmental Representative

- 15.1 The Contractor shall
- 15.1.1 permit the Departmental Representative to have access to the work and its site at all times during the performance of the contract;
 - 15.1.2 furnish the Departmental Representative with such information respecting the performance of the contract as he may require; and
 - 15.1.3 give the Departmental Representative every possible assistance to enable the Departmental Representative to carry out his duty to see that the work is performed in accordance with the contract and to carry out any other duties and exercise any powers specially imposed or conferred on the Departmental Representative under the contract.

CG16 Cooperation with Other Contractors

- 16.1 Where, in the opinion of the Departmental Representative, it is necessary that other contractors or workers with or without plant and material, be sent onto the work or its site, the Contractor shall, to the satisfaction of the Departmental Representative, allow them access and cooperate with them in the carrying out of their duties and obligation.
- 16.2 If
- 16.2.1 the sending onto the work or its site of other contractors or workers pursuant to GC16.1 could not have been reasonably foreseen or anticipated by the Contractor when entering into the contract, and



16.2.2 the Contractor incurs, in the opinion of the Departmental Representative, extra expense in complying with GC16.1, and

16.2.3 The Contractor has given the Departmental Representative written notice of his claim for the extra expense referred to in GC16.2.2 within 30 days of the date that the other contractors or workers were sent onto the work or its site,

Her Majesty shall pay the Contractor the cost, calculated in accordance with GC48 to GC50, of the extra labour, plant and material that was necessarily incurred.

GC17 Examination of Work

17.1 If, at any time after the commencement of the work but prior to the expiry of the warranty or guarantee period, the Departmental Representative has reason to believe that the work or any part thereof has not been performed in accordance with the contract, the Departmental Representative may have that work examined by an expert of his choice.

17.2 If, as a result of an examination of the work referred to in GC17.1, it is established that the work was not performed in accordance with the contract, then, in addition to and without limiting or otherwise affecting any of Her Majesty's rights and remedies under the contract either at law or in equity, the Contractor shall pay Her Majesty, on demand, all reasonable costs and expenses that were incurred by Her Majesty in having that examination performed.

GC18 Clearing of Site

18.1 The Contractor shall maintain the work and its site in a tidy condition and free from the accumulation of waste material and debris, in accordance with any directions of the Departmental Representative.

18.2 Before the issue of an interim certificate referred to in GC44.2, the Contractor shall remove all the plant and material not required for the performance of the remaining work, and all waste material and other debris, and shall cause the work and its site to be clean and suitable for occupancy by Her Majesty's servants, unless otherwise stipulated in the contract.

18.3 Before the issue of a final certificate referred to in GC44.1, the Contractor, shall remove from the work and its site all of the surplus plant and material and any waste material and other debris.

18.4 The Contractor's obligations described in GC18.1 to GC18.3 do not extend to waste material and other debris caused by Her Majesty's servants or contractors and workers referred to in GC16.1.

GC19 Contractor's Superintendent

19.1 The Contractor shall, forthwith upon the award of the contract, designate a superintendent.

19.2 The Contractor shall forthwith notify the Departmental Representative of the name, address and telephone number of a superintendent designate pursuant to GC19.1.



- 19.3 A superintendent designated pursuant to GC19.1 shall be in full charge of the operations of the Contractor in the performance of the work and is authorized to accept any notice, consent, order, direction, decision or other communication on behalf of the Contractor that may be given to the superintendent under the contract.
- 19.4 The Contractor shall, until the work has been completed, keep a competent superintendent at the work site during working hours.
- 19.5 The Contractor shall, upon the request of the Departmental Representative, remove any superintendent who, in the opinion of the Departmental Representative, is incompetent or has been conducting himself improperly and shall forthwith designate another superintendent who is acceptable to the Departmental Representative.
- 19.6 Subject to GC19.5, the Contractor shall not substitute a superintendent without the written consent of the Departmental Representative.
- 19.7 A breach by the Contractor of GC19.6 entitles the Departmental Representative to refuse to issue any certificate referred to in GC44 until the superintendent has returned to the work site or another superintendent who is acceptable to the Departmental Representative has been substituted.

GC20 National Security

- 20.1 If the Minister is of the opinion that the work is of a class or kind that involves the national security, he may order the Contractor
- 20.1.1 to provide him with any information concerning persons employed or to be employed by him for purposes of the contract; and
 - 20.1.2 to remove any person from the work and its site if, in the opinion of the Minister, that person may be a risk to the national security.
- 20.2 The Contractor shall, in all contracts with persons who are to be employed in the performance of the contract, make provision for his performance of any obligation that may be imposed upon him under GC19 to GC21.
- 20.3 The Contractor shall comply with an order of the Minister under GC20.1

GC21 Unsuitable Workers

- 21.1 The Contractor shall, upon the request of the Departmental Representative, remove any person employed by him for purposes of the contract who, in the opinion of the Departmental Representative, is incompetent or has conducted himself improperly, and the Contractor shall not permit a person who has been removed to return to the work site.

GC22 Increased or Decreased Costs



- 22.1 The amount set out in the Articles of Agreement shall not be increased or decreased by reason of any increase or decrease in the cost of the work that is brought about by an increase or decrease in the cost of labour, plant or material or any wage adjustment arising pursuant to the Labour Conditions.
- 22.2 Notwithstanding GC22.1 and GC35, an amount set out in the Articles of Agreement shall be adjusted in the manner provided in GC22.3, if any change in a tax imposed under the Excise Act, the Excise Tax Act, the Old Age Security Act, the Customs Act, the Customs Tariff or any provincial sales tax legislation imposing a retail sales tax on the purchase of tangible personal property incorporated into Real Property
- 22.2.1 occurs after the date of the submission by the Contractor of his tender for the contract,
- 22.2.2 applies to material, and
- 22.2.3 affects the cost to the Contractor of that material.
- 22.3 If a change referred to in GC22.2 occurs, the appropriate amount set out in the Articles of Agreement shall be increased or decreased by an amount equal to the amount that is established by an examination of the relevant records of the Contractor referred to in GC51 to be the increase or decrease in the cost incurred that is directly attributable to that change.
- 22.4 For the purpose of GC22.2, where a tax is changed after the date of submission of the tender but public notice of the change has been given by the Minister of Finance before that date, the change shall be deemed to have occurred before the date of submission of the tender.

GC23 Canadian Labour and Material

- 23.1 The Contractor shall use Canadian labour and material in the performance of the work to the full extent to which they are procurable, consistent with proper economy and expeditious carrying out of the work.
- 23.2 Subject to GC23.1, the Contractor shall, in the performance of the work, employ labour from the locality where the work is being performed to the extent to which it is available, and shall use the offices of the Canada Employment Centres for the recruitment of workers wherever practicable.
- 23.3 Subject to GC23.1 and GC23.2, the Contractor shall, in the performance of the work, employ a reasonable proportion of persons who have been on active service with the armed forces of Canada and have been honourably discharged therefrom.

GC24 Protection of Work and Documents

- 24.1 The Contractor shall guard or otherwise protect the work and its site, and protect the contract, specifications, plans, drawings, information, material, plant and real property, whether or not they are supplied by Her Majesty to the Contractor, against loss or damage from any cause, and he shall not use, issue, disclose or dispose of them without the written consent of the Minister, except as may be essential for the performance of the work.



- 24.2 If any document or information given or disclosed to the Contractor is assigned a security rating by the person who gave or disclosed it, the Contractor shall take all measures directed by the Departmental Representative to be taken to ensure the maintenance of the degree of security that is ascribed to that rating.
- 24.3 The Contractor shall provide all facilities necessary for the purpose of maintaining security, and shall assist any person authorized by the Minister to inspect or to take security measures in respect of the work and its site.
- 24.4 The Departmental Representative may direct the Contractor to do such things and to perform such additional work as the Departmental Representative considers reasonable and necessary to ensure compliance with or to remedy a breach of GC24.1 to GC24.3.

GC25 Public Ceremonies and Signs

- 25.1 The Contractor shall not permit any public ceremony in connection with the work without the prior consent of the Minister.
- 25.2 The Contractor shall not erect or permit the erection of any sign or advertising on the work or its site without the prior consent of the Departmental Representative.

GC26 Precautions against Damage, Infringement of Rights, Fire, and Other Hazards

- 26.1 The Contractor shall, at his own expense, do whatever is necessary to ensure that
- 26.1.1 no person, property, right, easement or privilege is injured, damaged or infringed by reasons of the Contractor's activities in performing the contract;
 - 26.1.2 pedestrian and other traffic on any public or private road or waterway is not unduly impeded, interrupted or endangered by the performance or existence of the work or plant;
 - 26.1.3 fire hazards in or about the work or its site are eliminated and, subject to any direction that may be given by the Departmental Representative, any fire is promptly extinguished;
 - 26.1.4 the health and safety of all persons employed in the performance of the work is not endangered by the method or means of its performance;
 - 26.1.5 adequate medical services are available to all persons employed on the work or its site at all times during the performance of the work;
 - 26.1.6 adequate sanitation measures are taken in respect of the work and its site; and
 - 26.1.7 all stakes, buoys and marks placed on the work or its site by or under the authority of the Departmental Representative are protected and are not removed, defaced, altered or destroyed.
- 26.2 The Departmental Representative may direct the Contractor to do such things and to perform such additional work as the Departmental Representative considers reasonable and necessary to ensure



compliance with or to remedy a breach of GC26.1.

- 26.3 The Contractor shall, at his own expense, comply with a direction of the Departmental Representative made under GC26.2.

GC27 Insurance

- 27.1 The Contractor shall, at his own expense, obtain and maintain insurance contracts in respect of the work and shall provide evidence thereof to the Departmental Representative in accordance with the requirements of the Insurance Conditions "E".

- 27.2 The insurance contracts referred to in GC27.1 shall

27.2.1 be in a form, of the nature, in the amounts, for the periods and containing the terms and conditions specified in Insurance Conditions "E", and

27.2.2 provide for the payment of claims under such insurance contracts in accordance with GC28.

GC28 Insurance Proceeds

- 28.1 In the case of a claim payable under a Builders Risk/Installation (All Risks) insurance contract maintained by the Contractor pursuant to GC27, the proceeds of the claim shall be paid directly to Her Majesty, and

28.1.1 the monies so paid shall be held by Her Majesty for the purposes of the contract, or

28.1.2 if Her Majesty elects, shall be retained by Her Majesty, in which event they vest in Her Majesty absolutely.

- 28.2 In the case of a claim payable under a General Liability insurance contract maintained by the Contractor pursuant to GC27, the proceeds of the claim shall be paid by the insurer directly to the claimant.

- 28.3 If an election is made pursuant to GC28.1, the Minister may cause an audit to be made of the accounts of the Contractor and of Her Majesty in respect of the part of the work that was lost, damaged or destroyed for the purpose of establishing the difference, if any, between

28.3.1 the aggregate of the amount of the loss or damage suffered or sustained by Her Majesty, including any cost incurred in respect of the clearing and cleaning of the work and its site and any other amount that is payable by the Contractor to Her Majesty under the contract, minus any monies retained pursuant to GC28.12, and

28.3.2 the aggregate of the amounts payable by Her Majesty to the Contractor pursuant to the contract up to the date of the loss or damage.

- 28.4 A difference that is established pursuant to GC28.3 shall be paid forthwith by the party who is determined by the audit to be the debtor to the party who is determined by the audit to be the



creditor.

- 28.5 When payment of a deficiency has been made pursuant to GC28.4, all rights and obligations of Her Majesty and the Contractor under the contract shall, with respect only to the part of the work that was the subject of the audit referred to in GC28.3, be deemed to have been expended and discharged.
- 28.6 If an election is not made pursuant to GC28.1.2 the Contractor shall, subject to GC28.7, clear and clean the work and its site and restore and replace the part of the work that was lost, damaged or destroyed at his own expense as if that part of the work had not yet been performed.
- 28.7 When the Contractor clears and cleans the work and its site and restores and replaces the work referred to in GC 28.6, Her Majesty shall pay him out of the monies referred to in GC28.1 so far as they will thereunto extend.
- 28.8 Subject to GC28.7, payment by Her Majesty pursuant to GC28.7 shall be made in accordance with the contract but the amount of each payment shall be 100% of the amount claimed notwithstanding TP4.4.1 and TP4.4.2.

GC29 Contract Security

- 29.1 The Contractor shall obtain and deliver contract security to the Departmental Representative in accordance with the provisions of the Contract Security Conditions.
- 29.2 If the whole or a part of the contract security referred to in GC29.1 is in the form of a security deposit, it shall be held and disposed of in accordance with GC43 and GC45.
- 29.3 If a part of the contract security referred to in GC29.1 is in the form of a labour and material payment bond, the Contractor shall post a copy of that bond on the work site.

GC30 Changes in the Work

- 30.1 Subject to GC5, the Departmental Representative may, at any time before he issues his Final Certificate of Completion,
- 30.1.1 order work or material in addition to that provided for in the Plans and Specifications;
and
- 30.1.2 delete or change the dimensions, character, quantity, quality, description, location or position of the whole or any part of the work or material provided for in the Plans and Specifications or in any order made pursuant to GC30.1.1,
- if that additional work or material, deletion, or change is, in his opinion, consistent with the general intent of the original contract.
- 30.2 The Contractor shall perform the work in accordance with such orders, deletions and changes that are made by the Departmental Representative pursuant to GC30.1 from time to time as if they had appeared in and been part of the Plans and Specifications.



- 30.3 The Departmental Representative shall determine whether or not anything done or omitted by the Contractor pursuant to an order, deletion or change referred to in GC30.1 increased or decreased the cost of the work to the Contractor.
- 30.4 If the Departmental Representative determines pursuant to GC30.3 that the cost of the work to the Contractor has been increased, Her Majesty shall pay the Contractor the increased cost that the Contractor necessarily incurred for the additional work calculated in accordance with GC49 or GC50.
- 30.5 If the Departmental Representative determines pursuant to GC30.3 that the cost of the work to the Contractor has been decreased, Her Majesty shall reduce the amount payable to the Contractor under the contract by an amount equal to the decrease in the cost caused by the deletion or change referred to in GC30.1.2 and calculated in accordance with GC49.
- 30.6 GC30.3 to GC30.5 are applicable only to a contract or a portion of a contract for which a Fixed Price Arrangement is stipulated in the contract.
- 30.7 An order, deletion or change referred to in GC30.1 shall be in writing, signed by the Departmental Representative and given to the Contractor in accordance with GC11.

GC31 Interpretation of Contract by Departmental Representative

- 31.1 If, at any time before the Departmental Representative has issued a Final Certificate of Completion referred to in GC44.1, any question arises between the parties about whether anything has been done as required by the contract or about what the Contractor is required by the contract to do, and, in particular but without limiting the generality of the foregoing, about
- 31.1.1 the meaning of anything in the Plans and Specification,
 - 31.1.2 the meaning to be given to the Plans and Specifications in case of any error therein, omission therefrom, or obscurity or discrepancy in their working or intention,
 - 31.1.3 whether or not the quality or quantity of any material or workmanship supplied or proposed to be supplied by the Contractor meets the requirements of the contract,
 - 31.1.4 whether or not the labour, plant or material provided by the Contractor for performing the work and carrying out the contract are adequate to ensure that the work will be performed in accordance with the contract and that the contract will be carried out in accordance with its terms,
 - 31.1.5 what quantity of any kind of work has been completed by the Contractor, or
 - 31.1.6 the timing and scheduling of the various phases of the performance of the work,
- the question shall be decided by the Departmental Representative whose decision shall be final and conclusive in respect of the work.
- 31.2 The Contractor shall perform the work in accordance with any decisions of the Departmental



Representative that are made under GC31.1 and in accordance with any consequential directions given by the Departmental Representative.

GC32 Warranty and Rectification of Defects in Work

- 32.1 Without restricting any warranty or guarantee implied or imposed by law or contained in the contract documents, the Contractor shall, at his own expense,
- 32.1.1 rectify and make good any defect or fault that appears in the work or comes to the attention of the Minister with respect to those parts of the work accepted in connection with the Interim Certificate of Completion referred to GC44.2 within 12 months from the date of the Interim Certificate of Completion;
- 32.1.2 rectify and make good any defect or fault that appears in or comes to the attention of the Minister in connection with those parts of the work described in the Interim Certificate of Completion referred to in GC44.2 within 12 months from the date of the Final Certificate of Completion referred to in GC44.1.
- 32.2 The Departmental Representative may direct the Contractor to rectify and make good any defect or fault referred to in GC32.1 or covered by any other expressed or implied warranty or guarantee.
- 32.3 A direction referred to in GC32.2 shall be in writing, may include a stipulation in respect of the time within which a defect or fault is required to be rectified and made good by the Contractor, and shall be given to the Contractor in accordance with GC11.
- 32.4 The Contractor shall rectify and make good any defect or fault described in a direction given pursuant to GC32.2 within the time stipulated therein.

GC33 Non-Compliance by Contractor

- 33.1 If the Contractor fails to comply with any decision or direction given by the Departmental Representative pursuant to GC18, GC24, GC26, GC31 or GC32, the Departmental Representative may employ such methods as he deems advisable to do that which the Contractor failed to do.
- 33.2 The Contractor shall, on demand, pay Her Majesty an amount that is equal to the aggregate of all cost, expenses and damage incurred or sustained by Her Majesty by reason of the Contractor's failure to comply with any decision or direction referred to in GC33.1, including the cost of any methods employed by the Departmental Representative pursuant to GC33.1.

GC34 Protesting Departmental Representative's Decisions

- 34.1 The Contractor may, within ten days after the communication to him of any decision or direction referred to in GC30.3 or GC33.1, protest that decision or direction.
- 34.2 A protest referred to in GC34.1 shall be in writing, contain full reasons for the protest, be signed



by the Contractor and be given to Her Majesty by delivery to the Departmental Representative.

- 34.3 If the Contractor gives a protest pursuant to GC34.2, any compliance by the Contractor with the decision or direction that was protested shall not be construed as an admission by the Contractor of the correctness of that decision or direction, or prevent the Contractor from taking whatever action he considers appropriate in the circumstances.
- 34.4 The giving of a protest by the Contractor pursuant to GC34.2 shall not relieve him from complying with the decision or direction that is the subject of the protest.
- 34.5 Subject to GC34.6, the Contractor shall take any action referred to in GC34.3 within three months after the date that a Final Certificate of Completion is issued under GC44.1 and not afterwards.
- 34.6 The Contractor shall take any action referred to in GC34.3 resulting from a direction under GC32 within three months after the expiry of a warranty or guarantee period and not afterwards.
- 34.7 Subject to GC34.8, if Her Majesty determines that the Contractor's protest is justified, Her Majesty shall pay the Contractor the cost of the additional labour, plant and material necessarily incurred by the Contractor in carrying out the protested decision or direction.
- 34.8 Costs referred to in GC34.7 shall be calculated in accordance with GC48 to GC50.

GC35 Changes in Soil Conditions and Neglect or Delay by Her Majesty

- 35.1 Subject to GC35.2 no payment, other than a payment that is expressly stipulated in the contract, shall be made by Her Majesty to the Contractor for any extra expense or any loss or damage incurred or sustained by the Contractor.
- 35.2 If the Contractor incurs or sustains any extra expense or any loss or damage that is directly attributable to
- 35.2.1 a substantial difference between the information relating to soil conditions at the work site that is contained in the Plans and Specifications or other documents supplied to the Contractor for his use in preparing his tender or a reasonable assumption of fact based thereon made by the Contractor, and the actual soil conditions encountered by the Contractor at the work site during the performance of the contract, or
- 35.2.2 any neglect or delay that occurs after the date of the contract on the part of Her Majesty in providing any information or in doing any act that the contract either expressly requires Her Majesty to do or that would ordinarily be done by an owner in accordance with the usage of the trade,

he shall, within ten days of the date the actual soil conditions described in GC35.2.1 were encountered or the neglect or delay described in GC35.2.2 occurred, give the Departmental Representative written notice of his intention to claim for that extra expense or that loss or damage.

- 35.3 When the Contractor has given a notice referred to in GC35.2, he shall give the Departmental Representative a written claim for extra expense or loss or damage within 30 days of the date that



a Final Certificate of Completion referred to in GC44.1 is issued and not afterwards.

- 35.4 A written claim referred to in GC35.3 shall contain a sufficient description of the facts and circumstances of the occurrence that is the subject of the claim to enable the Departmental Representative to determine whether or not the claim is justified and the Contractor shall supply such further and other information for that purpose as the Departmental Representative requires from time to time.
- 35.5 If the Departmental Representative determines that a claim referred to in GC35.3 is justified, Her Majesty shall make an extra payment to the Contractor in an amount that is calculated in accordance with GC47 to GC50.
- 35.6 If, in the opinion of the Departmental Representative, an occurrence described in GC35.2.1 results in a savings of expenditure by the Contractor in performing the contract, the amount set out in the Articles of Agreement shall, subject to GC35.7, be reduced by an amount that is equal to the saving.
- 35.7 The amount of the saving referred to in GC35.6 shall be determined in accordance with GC47 to GC49.
- 35.8 If the Contractor fails to give a notice referred to in GC35.2 and a claim referred to in GC35.3 within the times stipulated, an extra payment shall not be made to him in respect of the occurrence.

GC36 Extension of Time

- 36.1 Subject to GC36.2, the Departmental Representative may, on the application of the Contractor made before the day fixed by the Articles of Agreement for completion of the work or before any other date previously fixed under this General Condition, extend the time for its completion by fixing a new date if, in the opinion of the Departmental Representative, causes beyond the control of the Contractor have delayed its completion.
- 36.2 An application referred to in GC36.1 shall be accompanied by the written consent of the bonding company whose bond forms part of the contract security.

GC37 Assessments and Damages for Late Completion

- 37.1 For the purposes of this General Condition
- 37.1.1 the work shall be deemed to be completed on the date that an Interim Certificate of Completion referred to in GC44.2 is issued, and
- 37.1.2 "period of delay" means the number of days commencing on the day fixed by the Articles of Agreement for completion of the work and ending on the day immediately preceding the day on which the work is completed but does not include any day within a period of extension granted pursuant to GC36.1, and any other day on which, in the opinion of the Departmental Representative, completion of the work was delayed for reasons beyond the control of the Contractor.



- 37.2 If the Contractor does not complete the work by the day fixed for its completion by the Articles of Agreement but completes it thereafter, the Contractor shall pay Her Majesty an amount equal to the aggregate of
- 37.2.1 all salaries, wages and travelling expenses incurred by Her Majesty in respect of persons overseeing the performance of the work during the period of delay;
 - 37.2.2 the cost incurred by Her Majesty as a result of the inability to use the completed work for the period of delay; and
 - 37.2.3 all other expenses and damages incurred or sustained by Her Majesty during the period of delay as a result of the work not being completed by the day fixed for its completion.
- 37.3 The Minister may waive the right of Her Majesty to the whole or any part of the amount payable by the Contractor pursuant to GC37.2 I, in the opinion of the Minister, it is in the public interest to do so.

GC38 Taking the Work Out of the Contractor's Hands

- 38.1 The Minister may, at his sole discretion, by giving a notice in writing to the Contractor in accordance with GC11, take all or any part of the work out of the Contractor's hands, and may employ such means as he sees fit to have the work completed if the Contractor
- 38.1.1 Has not, within six days of the Minister or the Departmental Representative giving notice to the Contractor in writing in accordance with GC11, remedied any delay in the commencement or any default in the diligent performance of the work to the satisfaction of the Departmental Representative;
 - 38.1.2 has defaulted in the completion of any part of the work within the time fixed for its completion by the contract;
 - 38.1.3 has become insolvent;
 - 38.1.4 has committed an act of bankruptcy;
 - 38.1.5 has abandoned the work;
 - 38.1.6 has made an assignment of the contract without the consent required by GC3.1; or
 - 38.1.7 has otherwise failed to observe or perform any of the provisions of the contract.
- 38.2 If the whole or any part of the work is taken out of the Contractor's hands pursuant to GC38.1,
- 38.2.1 the Contractor's right to any further payment that is due or accruing due under the contract is, subject only to GC38.4, extinguished, and
 - 38.2.2 the Contractor is liable to pay Her Majesty, upon demand, an amount that is equal to the amount of all loss and damage incurred or sustained by Her Majesty in respect of the



Contractor's failure to complete the work.

- 38.3 If the whole or any part of the work that is taken out of the Contractor's hands pursuant to GC38.1 is completed by Her Majesty, the Departmental Representative shall determine the amount, if any, of the holdback or a progress claim that had accrued and was due prior to the date on which the work was taken out of the Contractor's hands and that is not required for the purposes of having the work performed or of compensating Her Majesty for any other loss or damage incurred or sustained by reason of the Contractor's default.
- 38.4 Her Majesty may pay the Contractor the amount determined not to be required pursuant to GC38.3.

GC39 Effect of Taking the Work Out of the Contractor's Hands

- 39.1 The taking of the work or any part thereof out of the Contractor's hands pursuant to GC38 does not operate so as to relieve or discharge him from any obligation under the contract or imposed upon him by law except the obligation to complete the performance of that part of the work that was taken out of his hands.
- 39.2 If the work or any part thereof is taken out of the Contractor's hands pursuant to GC38, all plant and material and the interest of the Contractor is all real property, licenses, powers and privileges acquired, used or provided by the Contractor under the contract shall continue to be the property of Her Majesty without compensation to the Contractor.
- 39.3 When the Departmental Representative certifies that any plant, material, or any interest of the Contractor referred to in GC39.2 is no longer required for the purposes of the work, or that it is not in the interest of Her Majesty to retain that plant, material or interest, it shall revert to the Contractor.

G40 Suspension of Work by Minister

- 40.1 The Minister may, when in his opinion it is in the public interest to do so, require the Contractor to suspend performance of the work either for a specified or an unspecified period by giving a notice of suspension in writing to the Contractor in accordance with GC11.
- 40.2 When a notice referred to in GC40.1 is received by the Contractor in accordance with GC11, he shall suspend all operations in respect of the work except those that, in the opinion of the Departmental Representative, are necessary for the care and preservation of the work, plant and material.
- 40.3 The Contractor shall not, during a period of suspension, remove any part of the work, plant or material from its site without the consent of the Departmental Representative.
- 40.4 If a period of suspension is 30 days or less, the Contractor shall, upon the expiration of that period, resume the performance of the work and he is entitled to be paid the extra cost, calculated in accordance with GC48 to GC50, of any labour, plant and material necessarily incurred by him as a result of the suspension.



- 40.5 If, upon the expiration of a period of suspension of more than 30 days, the Minister and the Contractor agree that the performance of the work will be continued by the Contractor, the Contractor shall resume performance of the work subject to any terms and conditions agreed upon by the Minister and the Contractor.
- 40.6 If, upon the expiration of a period of suspension of more than 30 days, the Minister and the Contractor do not agree that performance of the work will be continued by the Contractor or upon the terms and conditions under which the Contractor will continue the work, the notice of suspension shall be deemed to be a notice of termination pursuant to GC41.

GC41 Termination of Contract

- 41.1 The Minister may terminate the contract at any time by giving a notice of termination in writing to the Contractor in accordance with GC11.
- 41.2 When a notice referred to in GC41.1 is received by the Contractor in accordance with GC11, he shall, subject to any conditions stipulated in the notice, forthwith cease all operations in performance of the contract.
- 41.3 If the contract is terminated pursuant to GC41.1, Her Majesty shall pay the Contractor, subject to GC41.4, an amount equal to
- 41.3.1 the cost to the contractor of all labour, plant and material supplied by him under the contract up to the date of termination in respect of a contract or part thereof for which a Unit Price Arrangement is stipulated in the contract, or
 - 41.3.2 the lesser of
 - 41.3.2.1 an amount, calculated in accordance with the Terms and Payment, that would have been payable to the Contractor had he completed the work, and
 - 41.3.2.2 an amount that is determined to be due to the Contractor pursuant to GC49 in respect of a contract or part thereof for which a Fixed Price Arrangement is stipulated in the contract
- less the aggregate of all amounts that were paid to the Contractor by Her Majesty and all amounts that are due to Her Majesty from the Contractor pursuant to the contract.
- 41.4 If Her Majesty and the Contractor are unable to agree about an amount referred to in GC41.3 that amount shall be determined by the method referred to in GC50.

GC42 Claims Against and Obligations of the Contractor or Subcontractor

- 42.1 Her Majesty may, in order to discharge lawful obligations of and satisfy claims against the Contractor or a subcontractor arising out of the performance of the contract, pay any amount that is due and payable to the Contractor pursuant to the contract directly to the obligees of and the claimants against the Contractor or the subcontractor but such amount if any, as is paid by Her Majesty, shall not exceed that amount which the Contractor would have been obliged to pay to



such claimant had the provisions of the Provincial or Territorial lien legislation, or, in the Province of Quebec, the law relating to privileges, been applicable to the work. Any such claimant need not comply with the provisions of such legislation setting out the steps by way of notice, registration or otherwise as might have been necessary to preserve or perfect any claim for lien or privilege which claimant might have had;

- 42.2 Her Majesty will not make any payment as described in GC42.1 unless and until that claimant shall have delivered to Her Majesty:
- 42.2.1 a binding and enforceable Judgment or Order of a court of competent jurisdiction setting forth such amount as would have been payable by the Contractor to the claimant pursuant to the provisions of the applicable Provincial or Territorial lien legislation, or, in the Province of Quebec, the law relating to privileges, had such legislation been applicable to the work; or
 - 42.2.2 a final and enforceable award of an arbitrator setting forth such amount as would have been payable by the Contractor to the claimant pursuant to the provisions of the applicable Provincial or Territorial lien legislation, or, in the Province of Quebec, the law relating to privileges, had such legislation been applicable to the work; or
 - 42.2.3 the consent of the Contractor authorizing a payment.

For the purposes of determining the entitlement of a claimant pursuant to GC42.2.1 and GC42.2.2, the notice required by GC42.8 shall be deemed to replace the registration or provision of notice after the performance of work as required by any applicable legislation and no claim shall be deemed to have expired, become void or unenforceable by reason of the claimant not commencing any action within the time prescribed by any applicable legislation.

- 42.3 The Contractor shall, by the execution of his contract, be deemed to have consented to submit to binding arbitration at the request of any claimant those questions that need be answered to establish the entitlement of the claimant to payment pursuant to the provisions of GC42.1 and such arbitration shall have as parties to it any subcontractor to whom the claimant supplied material, performed work or rented equipment should such subcontractor wish to be adjoined and the Crown shall not be a party to such arbitration and, subject to any agreement between the Contractor and the claimant to the contrary, the arbitration shall be conducted in accordance with the Provincial or Territorial legislation governing arbitration applicable in the Province or Territory in which the work is located.
- 42.4 A payment made pursuant to GC42.1 is, to the extent of the payment, a discharge of Her Majesty's liability to the Contractor under the contract and may be deducted from any amount payable to the Contractor under the contract.
- 42.5 To the extent that the circumstances of the work being performed for Her Majesty permit, the Contractor shall comply with all laws in force in the Province or Territory where the work is being performed relating to payment period, mandatory holdbacks, and creation and enforcement of mechanics' liens, builders' liens or similar legislation or in the Province of Quebec, the law relating to privileges.
- 42.6 The Contractor shall discharge all his lawful obligations and shall satisfy all lawful claims against him arising out of the performance of the work at least as often as the contract requires Her



Majesty to pay the Contractor.

- 42.7 The Contractor shall, whenever requested to do so by the Departmental Representative, make a statutory declaration deposing to the existence and condition of any obligations and claims referred to in GC42.6.
- 42.8 GC42.1 shall only apply to claims and obligations
- 42.8.1 the notification of which has been received by the Departmental Representative in writing before payment is made to the Contractor pursuant to TP4.10 and within 120 days of the date on which the claimant
- 42.8.1.1 should have been paid in full under the claimant's contract with the Contractor or subcontractor where the claim is for money that was lawfully required to be held back from the claimant; or
- 42.8.1.2 performed the last of the services, work or labour, or furnished the last of the material pursuant to the claimant's contract with the Contractor or subcontractor where the claim is not for money referred to in GC42.8.1.1, and
- 42.8.2 the proceedings to determine the right to payment of which, pursuant to GC42.2. shall have commenced within one year from the date that the notice referred to in GC42.8.1 was received by the Departmental Representative, and
- the notification required by GC42.8.1 shall set forth the amount claimed to be owing and the person who by contract is primarily liable.
- 42.9 Her Majesty may, upon receipt of a notice of claim under GC42.8.1, withhold from any amount that is due and payable to the Contractor pursuant to the contract the full amount of the claim or any portion thereof.
- 42.10 The Departmental Representative shall notify the Contractor in writing of receipt of any claim referred to in GC42.8.1 and of the intention of Her Majesty to withhold funds pursuant to GC42.9 and the Contractor may, at any time thereafter and until payment is made to the claimant, be entitled to post, with Her Majesty, security in a form acceptable to Her Majesty in an amount equal to the value of the claim, the notice of which is received by the Departmental Representative and upon receipt of such security Her Majesty shall release to the Contractor any funds which would be otherwise payable to the Contractor, that were withheld pursuant to the provisions of GC42.9 in respect of the claim of any claimant for whom the security stands.

GC43 Security Deposit – Forfeiture or Return

- 43.1 If
- 43.1.1 the work is taken out of the Contractor's hands pursuant to GC38,
- 43.1.2 the contract is terminated pursuant to GC41, or
- 43.1.3 the Contractor is in breach of or in default under the contract,



Her Majesty may convert the security deposit, if any, to Her own use.

- 43.2 If Her Majesty converts the contract security pursuant to GC43.1, the amount realized shall be deemed to be an amount due from Her Majesty to the Contractor under the contract.
- 43.3 Any balance of an amount referred to in GC43.2 that remains after payment of all losses, damage and claims of Her Majesty and others shall be paid by Her Majesty to the Contractor if, in the opinion of the Departmental Representative, it is not required for the purposes of the contract.

GC44 Departmental Representative's Certificates

44.1 On the date that

44.1.1 the work has been completed, and

44.1.2 the Contractor has complied with the contract and all orders and directions made pursuant thereto,

both to the satisfaction of the Departmental Representative, the Departmental Representative shall issue a Final Certificate of Completion to the Contractor.

44.2 If the Departmental Representative is satisfied that the work is substantially complete he shall, at any time before he issues a certificate referred to in GC44.1, issue an Interim Certificate of Completion to the Contractor, and

44.2.1 for the purposes of GC44.2 the work will be considered to be substantially complete,

44.2.1.1 when the work under the contract or a substantial part thereof is, in the opinion of the Departmental Representative, ready for use by Her Majesty or is being used for the purpose intended; and

44.2.1.2 when the work remaining to be done under the contract is, in the opinion of the Departmental Representative, capable of completion or correction at accost of not more than

44.2.1.2.1 -3% of the first \$500,000, and

44.2.1.2.2 -2% of the next \$500,000, and

44.2.1.2.3 -1% of the balance

of the value of the contract at the time this cost is calculated.

44.3 For the sole purpose of GC44.2.1.2, where the work or a substantial part thereof is ready for use or is being used for the purposes intended and the remainder of the work or a part thereof cannot be completed by the time specified in A2.1, or as amended pursuant to GC36, for reasons beyond the control of the Contractor or where the Departmental Representative and the Contractor agree not to complete a part of the work within the specified time, the cost of that part of the work



which was either beyond the control of the Contractor to complete or the Departmental Representative and the Contractor have agreed not to complete by the time specified shall be deducted from the value of the contract referred to GC44.2.1.2 and the said cost shall not form part of the cost of the work remaining to be done in determining substantial completion.

44.4 An Interim Certificate of Completion referred to in GC44.2 shall describe the parts of the work not completed to the satisfaction of the Departmental Representative and all things that must be done by the Contractor

44.4.1 before a Final Certificate of Completion referred to in GC44.1 will be issued, and

44.4.2 before the 12-month period referred to in GC32.1.2 shall commence for the said parts and all the said things.

44.5 The Departmental Representative may, in addition to the parts of the work described in an Interim Certificate of Completion referred to in GC44.2, require the Contractor to rectify any other parts of the work not completed to his satisfaction and to do any other things that are necessary for the satisfactory completion of the work.

44.6 If the contract or a part thereof is subject to a Unit Price Arrangement, the Departmental Representative shall measure and record the quantities of labour, plant and material, performed, used and supplied by the Contractor in performing the work and shall, at the request of the Contractor, inform him of those measurements.

44.7 The Contractor shall assist and co-operate with the Departmental Representative in the performance of his duties referred to in GC44.6 and shall be entitled to inspect any record made by the Departmental Representative pursuant to GC44.6.

44.8 After the Departmental Representative has issued a Final Certificate of Completion referred to in GC44.1, he shall, if GC44.6 applies, issue a Final Certificate of Measurement.

44.9 A Final Certificate of Measurement referred to in GC44.8 shall

44.9.1 contain the aggregate of all measurements of quantities referred to in GC44.6, and

44.9.2 be binding upon and conclusive between Her Majesty and the Contractor as to the quantities referred to therein.

GC45 Return of Security Deposit

45.1 After an Interim Certificate of Completion referred to in GC44.2 has been issued, Her Majesty shall, if the Contractor is not in breach of or in default under the contract, return to the Contractor all or any part of the security deposit that, in the opinion of the Departmental Representative, is not required for the purposes of the contract.

45.2 After a Final Certificate of Completion referred to in GC44.1 has been issued, Her Majesty shall return to the Contractor the remainder of any security deposit unless the contract stipulates otherwise.



- 45.3 If the security deposit was paid into the Consolidated Revenue Fund of Canada, Her Majesty shall pay interest thereon to the Contractor at a rate established from time to time pursuant to section 21(2) of the Financial Administration Act.

GC46 Clarification of Terms in GC47 to GC50

- 46.1 For the purposes of GC47 to GC50,
- 46.1.1 "Unit Price Table" means the table set out in the Articles of Agreement, and
- 46.1.2 "plant" does not include tools customarily provided by a tradesman in practicing his trade.

GC47 Additions or Amendments to Unit Price Table

- 47.1 Where a Unit Price Arrangement applies to the contract or a part thereof the Departmental Representative and the Contractor may, by an agreement in writing,
- 47.1.1 add classes of labour or material, and units of measurement, prices per unit and estimated quantities to the Unit Price Table if any labour, plant or material that is to be included in the Final Certificate of Measurement referred to in GC44.8 is not included in any class of labour, plant or material set out in the Unit Price Table; or
- 47.1.2 subject to GC47.2 and GC47.3, amend a price set out in the Unit Price Table for any class of labour, plant or material included therein if the Final Certificate of Measurement referred to in GC44.8 shows or is expected to show that the total quantity of that class of labour, plant or material actually performed, used or supplied by the Contractor in performing the work is
- 47.1.2.1 less than 85% of that estimated total quantity, or
- 47.1.2.2 in excess of 115% of that estimated total quantity.
- 47.2 In no event shall the total cost of an item set out in the Unit Price Table that has been amended pursuant to GC47.1.2.1 exceed the amount that would have been payable to the Contractor had the estimated total quantity actually been performed, used or supplied.
- 47.3 An amendment that is made necessary by GC47.1.2.2 shall apply only to the quantities that are in excess of 115%.
- 47.4 If the Departmental Representative and the Contractor do not agree as contemplated in GC47.1, the Departmental Representative shall determine the class and the unit of measurement of the labour, plant or material and, subject to GC47.2 and GC47.3, the price per unit therefore shall be determined in accordance with GC50.

GC48 Determination of Cost – Unit Price Table



- 48.1 Whenever, for the purposes of the contract, it is necessary to determine the cost of labour, plant or material, it shall be determined by multiplying the quantity of that labour, plant or material expressed in the unit set out in column 3 of the Unit Price Table by the price of that unit set out in column 5 of the Unit Price Table.

GC49 Determination of Cost – Negotiation

- 49.1 If the method described in GC48 cannot be used because the labour, plant or material is of a kind or class that is not set out in the Unit Price Table, the cost of that labour, plant or material for the purposes of the contract shall be the amount agreed upon from time to time by the Contractor and the Departmental Representative.
- 49.2 For the purposes of GC49.1, the Contractor shall submit to the Departmental Representative any necessary cost information requested by the Departmental Representative in respect of the labour, plant and material referred to in GC49.1

GC50 Determination of Cost – Failing Negotiation

- 50.1 If the methods described in GC47, GC48 or GC49 fail for any reason to achieve a determination of the cost of labour, plant and material for the purposes referred to therein, that cost shall be equal to the aggregate of
- 50.1.1 all reasonable and proper amounts actually expended or legally payable by the Contractor in respect of the labour, plant and material that falls within one of the classes of expenditure described in GC50.2 that are directly attributable to the performance of the contract,
 - 50.1.2 an allowance for profit and all other expenditures or costs, including overhead, general administration cost, financing and interest charges, and every other cost, charge and expenses, but not including those referred to in GC50.1.1 or GC50.1.3 or a class referred to in GC50.2, in an amount that is equal to 10% of the sum of the expenses referred to in GC50.1.1, and
 - 50.1.3 interest on the cost determined under GC50.1.1 and GC50.1.2, which interest shall be calculated in accordance with TP9,

provide that the total cost of an item set out in the Unit Price Table that is subject to the provisions of GC47.1.2.1 does not exceed the amount that would have been payable to the Contractor had the estimated total quantity of the said item actually be performed, used or supplied.

- 50.2 For purposes of GC50.1.1 the classes of expenditure that may be taken into account in determining the cost of labour, plant and material are,
- 50.2.1 payments to subcontractors;
 - 50.2.2 wages, salaries and travelling expenses of employees of the Contractor while they are actually and properly engaged on the work, other than wages, salaries, bonuses, living



and travelling expenses of personnel of the Contractor generally employed at the head office or at a general office of the Contractor unless they are engaged at the work site with the approval of the Departmental Representative,

- 50.2.3 assessments payable under any statutory authority relating to workmen's compensation, unemployment insurance, pension plan or holidays with pay;
- 50.2.4 rent that is paid for plant or an amount equivalent of the said rent if the plant is owned by the Contractor that is necessary for and used in the performance of the work, if the rent of the equivalent amount is reasonable and use of that plant has been approved by the Departmental Representative;
- 50.2.5 payments for maintaining and operating plant necessary for and used in the performance of the work, and payments for effecting such repairs thereto as, in the opinion of the Departmental Representative, are necessary to the proper performance of the contract other than payments for any repairs to the plant arising out of defects existing before its allocation to the work;
- 50.2.6 payments for material that is necessary for and incorporated in the work, or that is necessary for and consumed in the performance of the contract;
- 50.2.7 payments for preparation, delivery, handling, erection, installation, inspection protection and removal of the plant and material necessary for and used in the performance of the contract; and
- 50.2.8 any other payments made by the Contractor with the approval of the Departmental Representative that are necessary for the performance of the contract.

GC51 Records to be kept by Contractor

51.1 The Contractor shall

- 51.1.1 maintain full records of his estimated and actual cost of the work together with all tender calls, quotations, contracts, correspondence, invoices, receipts and vouchers relating thereto.
- 51.1.2 make all records and material referred to in GC5.1.1 available to audit and inspection by the Minister and the Deputy Receiver General for Canada or by persons acting on behalf of either of both of them, when requested;
- 51.1.3 allow any of the person referred to in GC51.1.2 to make copies of and to take extracts from any of the records and material referred to in GC51.1.1; and
- 51.1.4 furnish any person referred to in GC51.1.2 with any information he may require from time to time in connection with such records and material.

- 51.2 The records maintained by the Contractor pursuant to GC51.1.1 shall be kept intact by the Contractor until the expiration of two years after the date that a Final Certificate of Completion referred to in GC44.1 was issued or until the expiration of such other period of time as the



Minister may direct.

- 51.3 The Contractor shall cause all subcontractors and all other persons directly or indirectly controlled by or affiliated with the Contractor and all persons directly or indirectly having control of the Contractor to comply with GC51.1 and GC51.2 as if they were the Contractor.

GC52 Conflict of Interest

- 52.1 It is a term of this contract that no former public office holder who is not in compliance with the Conflict of Interest and Post-Employment Code for Public Office Holders shall derive a direct benefit from this contract.

GC53 Contractor Status

- 53.1 The Contractor shall be engaged under the contract as an independent contractor.
- 53.2 The Contractor and any employee of the said Contractor is not engaged by the contract as an employee, servant or agent of Her Majesty.
- 53.3 For the purposes of GC53.1 and GC53.2 the Contractor shall be solely responsible for any and all payments and deductions required to be made by law including those required for Canada or Quebec Pension Plans, Unemployment Insurance, Worker's Compensation or Income Tax.



GENERAL CONDITONS

- IC 1 Proof of Insurance**
- IC 2 Risk Management**
- IC 3 Payment of Deductible**
- IC 4 Insurance Coverage**

GENERAL INSUANCE COVERAGES

- GCI 1 Insured**
- GIC 2 Period of Insurance**
- GIC 3 Proof of Insurance**
- GIC 4 Notification**

COMMERCIAL GENERAL LIABILITY

- CGL 1 Scope of Policy**
- CGL 2 Coverages/Provisions**
- CGL 3 Additional Exposures**
- CGL 4 Insurance Proceeds**
- CGL 5 Deductible**

BUILDER'S RISK – INSTALLATION FLOATER – ALL RISKS

- BR 1 Scope of Policy**
- BR 2 Property Insured**
- BR 3 Insurance Proceeds**
- BR 4 Amount of Insurance**
- BR 5 Deductible**
- BR 6 Subrogation**
- BR 7 Exclusion Qualifications**

INSURER'S CERTIFICATE OF INSURANCE



General Conditions

IC 1 Proof of Insurance (02/12/03)

Within thirty (30) days after acceptance of the Contractor's tender, the Contractor shall, unless otherwise directed in writing by the Contracting Officer, deposit with the Contracting Officer an Insurer's Certificate of Insurance in the form displayed in this document and, if requested by the Contracting Officer, the originals or certified true copies of all contracts of insurance maintained by the Contractor pursuant to the Insurance Coverage Requirements shown hereunder.

IC 2 Risk Management (01/10/94)

The provisions of the Insurance Coverage Requirements contained hereunder are not intended to cover all of the Contractor's obligations under GC8 of the General Conditions "C" of the contract. Any additional risk management measures or additional insurance coverages the Contractor may deem necessary to fulfill its obligations under GC8 shall be at its own discretion and expense.

IC 3 Payment of Deductible (01/10/94)

The payment of monies up to the deductible amount made in satisfaction of a claim shall be borne by the Contractor.

IC 4 Insurance Coverage (02/12/03)

The Contractor has represented that it has in place and effect the appropriate and usual liability insurance coverage as required by these Insurance Conditions and the Contractor has warranted that it shall obtain, in a timely manner and prior to commencement of the Work, the appropriate and usual property insurance coverage as required by these Insurance Conditions and, further, that it shall maintain all required insurance policies in place and effect as required by these Insurance Conditions.



INSURANCE COVERAGE REQUIREMENTS

PART I GENERAL INSURANCE COVERAGES (GIC)

GCI 1 Insured (02/12/03)

Each insurance policy shall insure the Contractor, and shall include, as an Additional Named Insured, Her Majesty the Queen in right of Canada, represented by the National Research Council Canada.

GIC 2 Period of Insurance (02/12/03)

Unless otherwise directed in writing by the Contracting Officer or otherwise stipulated elsewhere in these Insurance Conditions, the policies required hereunder shall be in force and be maintained from the date of the contract award until the day of issue of the Departmental Representative's Final Certificate of Completion.

GIC 3 Proof of Insurance (01/10/94)

Within twenty five (25) days after acceptance of the Contractor's tender, the Insurer shall, unless otherwise directed by the Contractor, deposit with the Contractor an Insurer's Certificate of Insurance in the form displayed in the document and, if requested, the originals or certified true copies of all contracts of insurance maintained by the Contractor pursuant to the requirements of these Insurance Coverages.

GIC 4 Notification (01/10/94)

Each Insurance policy shall contain a provision that (30) days prior written notice shall be given by the Insurer to Her Majesty in the event of any material change in or cancellation of coverage. Any such notice received by the Contractor shall be transmitted forthwith to Her Majesty.

PART II COMMERCIAL GENERAL LIABILITY

CGL 1 Scope of Policy (01/10/94)

The policy shall be written on a form similar to that known and referred to in the insurance industry as IBC 2100 – Commercial General Liability policy (Occurrence form) and shall provide for limit of liability of not less than \$2,000,000 inclusive for Bodily Injury and Property Damage for any one occurrence or series of occurrences arising out of one cause. Legal or defence cost incurred in respect of a claim or claims shall not operate to decrease the limit of liability.

CGL 2 Coverages/Provisions (01/10/94)



The policy shall include but not necessarily be limited to the following coverages/provisions.

- 2.1 Liability arising out of or resulting from the ownership, existence, maintenance or use of premises by the Contractor and operations necessary or incidental to the performance of this contract.
- 2.2 "Broad Form" Property Damage including the loss of use of property.
- 2.3 Removal or weakening of support of any building or land whether such support be natural or otherwise.
- 2.4 Elevator liability (including escalators, hoists and similar devices).
- 2.5 Contractor's Protective Liability
- 2.6 Contractual and Assumed Liabilities un this contact.
- 2.7 Completed Operations Liability – The insurance, including all aspects of this Part II of these Insurance Conditions shall continue for a period of at least one (1) year beyond the date of the Departmental Representative's Final Certificate of Completion for the Completed Operations.
- 2.8 Cross Liability – The Clause shall be written as follows:

Cross Liability – The insurance as is afforded by this policy shall apply in respect to any claim or action brought against any one Insured by any other Insured. The coverage shall apply in the same manner and to the same extent as though a separate policy had been issued to each Insured. The inclusion herein of more than one Insured shall not increase the limit of the Insurer's liability.

- 2.9 Severability of Interests – The Clause shall be written as follows:

Severability of Interests – This policy, subject to the limits of liability stated herein, shall apply separately to each Insured in the same manner and to the same extent as if a separate policy had been issued to each. The inclusion herein of more than one insured shall not increase the limit of the Insurer's liability.

CGL 3 Additional Exposures (02/12/03)

The policy shall either include or be endorsed to include the following exposures of hazards if the Work is subject thereto:

- 3.1 Blasting
- 3.2 Pile driving and calsson work
- 3.3 Underpinning
- 3.4 Risks associated with the activities of the Contractor on an active airport



- 3.5 Radioactive contamination resulting from the use of commercial isotopes
- 3.6 Damage to the portion of an existing building beyond that directly associated with an addition, renovation or installation contract.
- 3.7 Marine risks associated with the contraction of piers, wharves and docks.

**CGL 4 Insurance Proceeds
(01/10/94)**

Insurance Proceeds from this policy are usually payable directly to a Claimant/Third Party.

**CGL 5 Deductible
(02/12/03)**

This policy shall be issued with a deductible amount of not more than \$10,000 per occurrence applying to Property Damage claims only.

**PART III
BUILDER'S RISK - INSTALLATION FLOATER - ALL RISKS**

**BR 1 Scope of Policy
(01/10/94)**

The policy shall be written on an "All Risks" basis granting coverages similar to those provided by the forms known and referred to in the insurance industry as "Builder's Risk Comprehensive Form" or "Installation Floater - All Risks".

**BR 2 Property Insured
(01/10/94)**

The property insured shall include:

- 2.1 The Work and all property, equipment and materials intended to become part of the finished Work at the site of the project while awaiting, during and after installation, erection or construction including testing.
- 2.2 Expenses incurred in the removal from the construction site of debris of the property insured, including demolition of damaged property, de-icing and dewatering, occasioned by loss, destruction or damage to such property and in respect of which insurance is provided by this policy.

**BR 3 Insurance Proceeds
(01/10/94)**

- 3.1 Insurance proceeds from this policy are payable in accordance with GC28 of the General Conditions "C" of the contract.
- 3.2 This policy shall provide that the proceeds thereof are payable to Her Majesty or as the Minister may direct.



- 3.3 The Contractor shall do such things and execute such documents as are necessary to effect payment of the proceeds.

BR 4 Amount of Insurance
(01/10/94)

The amount of insurance shall not be less than the sum of the contract value plus the declared value (if any) set forth in the contract documents of all material and equipment supplied by Her Majesty at the site of the project to be incorporated into and form part of the finished Work.

BR 5 Deductible
(02/12/03)

The Policy shall be issued with a deductible amount of not more than \$10,000.

BR 6 Subrogation
(01/10/94)

The following Clause shall be included in the policy:

"All rights of subrogation or transfer of rights are hereby waived against any corporation, firm, individual or other interest, with respect to which, insurance is provided by this policy".

BR 7 Exclusion Qualifications
(01/10/94)

The policy may be subject to the standard exclusions but the following qualifications shall apply:

- 7.1 Faulty materials, workmanship or design may be excluded only to the extent of the cost of making good thereof and shall not apply to loss or damage resulting therefrom.
- 7.2 Loss or damage caused by contamination by radioactive material may be excluded except for loss or damage resulting from commercial isotopes used for industrial measurements, inspection, quality control radiographic or photographic use.
- 7.3 Use and occupancy of the project or any part of section thereof shall be permitted where such use and occupancy is for the purpose for which the project is intended upon completion.



INSURER'S CERTIFICATE OF INSURANCE

(TO BE COMPLETED BY INSURER (NOT BOKER) AND DELIVERD TO NATIONAL RESEARCH COUNCIL CANADA WITH 30 DAYS FOLLOWING ACCEPTANCE OF TENDER)

CONTRACT

DESCRIPTION OF WORK	CONTRACT NUMBER	AWARD DATE
LOCATION		

INSURER

NAME
ADDRESS

BROKER

NAME
ADDRESS

INSURED

NAME OF CONTRACTOR
ADDRESS

ADDITIONAL INSURED

HER MAJESTY THE QUEEN IN RIGHT OF CANADA AS REPRESENTED BY THE NATIONAL RESEARCH COUNCIL CANADA

THIS DOCUENT CERTIFIES THAT THE FOLLOWING POLICES OF INSURANCE ARE AT PRESENT IN FORCE COVERING ALL OPERATIONS OF THE INSURE IN CONNECTION WITH THE CONTRACT MADE BETWEEN THE NAMED INSURED AND THE NATIONAL RESEARCH COUNCIL CANADA AND IN ACCORDANCE WITH THE INSURANCE CONDITIONS "E"

POLICY					
TYPE	NUMBER	INCEPTION DATE	EXPIRY DATE	LIMITS OF LIABILITY	DEDUCTIBLE
COMMERCIAL GENERAL LIABILITY					
BUILDERS RISK "AL RISKS"					
INSTALLATION FLOATER "ALL RISKS"					

THE INSURER AGREES TO NOTIFY THE NATIONAL RESEARCH COUNCIL CANADA IN WRITING 30 DAYS PRIOR TO ANY MATERIAL CHANGE IN OR CANCELLATION OF ANY POLICY OR COVERAGE SPECIFICALLY RELATED TO THE CONTRACT

NAME OF INSURER'S OFFICER OR AUTHORIZED EMPLOYEE	SIGNATURE	DATE:
		TELEPHONE NUMBER:

ISSUANCE OF THIS CERTIFIATE SHALL NOT LIMIT OR RESTRICT THE RIGHT OF THE NATIONAL RESEARCH COUNCIL CANADA TO REQUEST AT ANY TIME DUPLICATE COPIES OF SAID INSURANCE POLICIES



CS1 Obligation to provide Contract Security

- 1.1 The Contractor shall, at the Contractor's own expense, provide one or more of the forms of contract security prescribed in CS2.
- 1.2 The Contractor shall deliver to the Departmental Representative the contract security referred to in CS1.1 within 14 days after the date that the Contractor receives notice that the Contractor's tender or offer was accepted by Her Majesty.

CS2 Prescribed Types and Amounts of Contract Security

- 2.1 The Contractor shall deliver to the Departmental Representative pursuant to CS1
 - 2.1.1 a performance bond and a labour and material payment bond each in an amount that is equal to not less than 50% of the contract amount referred to in the Articles of Agreement, or
 - 2.1.2 a labour and material payment bond in an amount that is equal to not less than 50% of the contract amount referred to in the Articles of Agreement, and a security deposit in an amount that is equal to
 - 2.1.2.1 not less than 10% of the contract amount referred to in the Articles of Agreement where that amount does not exceed \$250,000, or
 - 2.1.2.2 \$25,000 plus 5% of the part of the contract amount referred to in the Articles of Agreement that exceeds \$250,000, or
 - 2.1.3 a security deposit in an amount prescribed by CS2.12 plus an additional amount that is equal to 10% of the contract amount referred to in the Articles of Agreement.
- 2.2 A performance bond and a labour and material payment bond referred to in CS2.1 shall be in a form and be issued by a bonding or surety company that is approved by Her Majesty.
- 2.3 The amount of a security deposit referred to in CS2.1.2 shall not exceed \$250,000 regardless of the contract amount referred to in the Articles of Agreement.
- 2.4 A security deposit referred to in CS2.1.2 and CS2.1.3 shall be in the form of
 - 2.4.1 a bill of exchange made payable to the Receiver General of Canada and certified by an approved financial institution or drawn by an approved financial institution on itself, or
 - 2.4.2 bonds of or unconditionally guaranteed as to principal and interest by the Government of Canada.
- 2.5 For the purposes of CS2.4
 - 2.5.1 a bill of exchange is an unconditional order in writing signed by the Contractor and addressed to an approved financial institution, requiring the said institution to pay, on demand, at a fixed or determinable future time a sum certain of money to, or to the order



of, the Receiver General for Canada, and

- 2.5.2 If a bill of exchange is certified by a financial institution other than a chartered bank then it must be accompanied by a letter or stamped certification confirming that the financial institution is in at least one of the categories referred to in CS2.5.3
- 2.5.3 an approved financial institution is
 - 2.5.3.1 any corporation or institution that is a member of the Canadian Payments Association,
 - 2.5.3.2 a corporation that accepts deposits that are insured by the Canada Deposit Insurance Corporation or the Régie de l'assurance-dépôts du Québec to the maximum permitted by law,
 - 2.5.3.3 a credit union as defined in paragraph 137(6)(b) of the *Income Tax Act*,
 - 2.5.3.4 a corporation that accepts deposits from the public, if repayment of the deposit is guaranteed by Her Majesty in right of a province, or
 - 2.5.3.5 The Canada Post Corporation.
- 2.5.4 the bonds referred to in CS2.4.2 shall be
 - 2.5.4.1 made payable to bearer, or
 - 2.5.4.2 accompanied by a duly executed instrument of transfer of the bonds to the Receiver General for Canada in the form prescribed by the Domestic Bonds of Canada Regulations, or
 - 2.5.4.3 registered, as to principal or as to principal and interest in the name of the Receiver General for Canada pursuant to the Domestic Bonds of Canada Regulations, and
 - 2.5.4.4 provided on the basis of their market value current at the date of the contract.



**SECURITY REQUIREMENTS CHECK LIST (SRCL)
LISTE DE VÉRIFICATION DES EXIGENCES RELATIVES À LA SÉCURITÉ (LVERS)**

PART A - CONTRACT INFORMATION / PARTIE A - INFORMATION CONTRACTUELLE		
1. Originating Government Department or Organization / Ministère ou organisme gouvernemental d'origine Conseil National de Recherche du Canada		2. Branch or Directorate / Direction générale ou Direction SAGI- Boucherville
3. a) Subcontract Number / Numéro du contrat de sous-traitance	3. b) Name and Address of Subcontractor / Nom et adresse du sous-traitant	
4. Brief Description of Work / Brève description du travail Refection de la toiture secteur L1-L2		
5. a) Will the supplier require access to Controlled Goods? Le fournisseur aura-t-il accès à des marchandises contrôlées?		<input checked="" type="checkbox"/> No / Non <input type="checkbox"/> Yes / Oui
5. b) Will the supplier require access to unclassified military technical data subject to the provisions of the Technical Data Control Regulations? Le fournisseur aura-t-il accès à des données techniques militaires non classifiées qui sont assujetties aux dispositions du Règlement sur le contrôle des données techniques?		<input checked="" type="checkbox"/> No / Non <input type="checkbox"/> Yes / Oui
6. Indicate the type of access required / Indiquer le type d'accès requis		
6. a) Will the supplier and its employees require access to PROTECTED and/or CLASSIFIED information or assets? Le fournisseur ainsi que les employés auront-ils accès à des renseignements ou à des biens PROTÉGÉS et/ou CLASSIFIÉS? (Specify the level of access using the chart in Question 7. c) (Préciser le niveau d'accès en utilisant le tableau qui se trouve à la question 7. c)		<input checked="" type="checkbox"/> No / Non <input type="checkbox"/> Yes / Oui
6. b) Will the supplier and its employees (e.g. cleaners, maintenance personnel) require access to restricted access areas? No access to PROTECTED and/or CLASSIFIED information or assets is permitted. Le fournisseur et ses employés (p. ex. nettoyeurs, personnel d'entretien) auront-ils accès à des zones d'accès restreintes? L'accès à des renseignements ou à des biens PROTÉGÉS et/ou CLASSIFIÉS n'est pas autorisé.		<input type="checkbox"/> No / Non <input checked="" type="checkbox"/> Yes / Oui
6. c) Is this a commercial courier or delivery requirement with no overnight storage? S'agit-il d'un contrat de messagerie ou de livraison commerciale sans entreposage de nuit?		<input checked="" type="checkbox"/> No / Non <input type="checkbox"/> Yes / Oui
7. a) Indicate the type of information that the supplier will be required to access / Indiquer le type d'information auquel le fournisseur devra avoir accès		
Canada <input checked="" type="checkbox"/>	NATO / OTAN <input type="checkbox"/>	Foreign / Étranger <input type="checkbox"/>
7. b) Release restrictions / Restrictions relatives à la diffusion		
No release restrictions Aucune restriction relative à la diffusion <input type="checkbox"/>	All NATO countries Tous les pays de l'OTAN <input type="checkbox"/>	No release restrictions Aucune restriction relative à la diffusion <input type="checkbox"/>
Not releasable À ne pas diffuser <input type="checkbox"/>		
Restricted to: / Limité à: Specify country(ies): / Préciser le(s) pays: <input type="checkbox"/>	Restricted to: / Limité à: Specify country(ies): / Préciser le(s) pays: <input type="checkbox"/>	Restricted to: / Limité à: Specify country(ies): / Préciser le(s) pays: <input type="checkbox"/>
7. c) Level of information / Niveau d'information		
PROTECTED A <input type="checkbox"/>	NATO UNCLASSIFIED <input type="checkbox"/>	PROTECTED A <input type="checkbox"/>
PROTÉGÉ A <input type="checkbox"/>	NATO NON CLASSIFIÉ <input type="checkbox"/>	PROTÉGÉ A <input type="checkbox"/>
PROTECTED B <input type="checkbox"/>	NATO RESTRICTED <input type="checkbox"/>	PROTECTED B <input type="checkbox"/>
PROTÉGÉ B <input type="checkbox"/>	NATO DIFFUSION RESTREINTE <input type="checkbox"/>	PROTÉGÉ B <input type="checkbox"/>
PROTECTED C <input type="checkbox"/>	NATO CONFIDENTIAL <input type="checkbox"/>	PROTECTED C <input type="checkbox"/>
PROTÉGÉ C <input type="checkbox"/>	NATO CONFIDENTIEL <input type="checkbox"/>	PROTÉGÉ C <input type="checkbox"/>
CONFIDENTIAL <input type="checkbox"/>	NATO SECRET <input type="checkbox"/>	CONFIDENTIAL <input type="checkbox"/>
CONFIDENTIEL <input type="checkbox"/>	NATO SECRET <input type="checkbox"/>	CONFIDENTIEL <input type="checkbox"/>
SECRET <input type="checkbox"/>	COSMIC TOP SECRET <input type="checkbox"/>	SECRET <input type="checkbox"/>
SECRET <input type="checkbox"/>	COSMIC TRÈS SECRET <input type="checkbox"/>	SECRET <input type="checkbox"/>
TOP SECRET <input type="checkbox"/>		TOP SECRET <input type="checkbox"/>
TRÈS SECRET <input type="checkbox"/>		TRÈS SECRET <input type="checkbox"/>
TOP SECRET (SIGINT) <input type="checkbox"/>		TOP SECRET (SIGINT) <input type="checkbox"/>
TRÈS SECRET (SIGINT) <input type="checkbox"/>		TRÈS SECRET (SIGINT) <input type="checkbox"/>



Contract Number / Numéro du contrat
Security Classification / Classification de sécurité

PART A (continued) / PARTIE A (suite)

8. Will the supplier require access to PROTECTED and/or CLASSIFIED COMSEC information or assets?
Le fournisseur aura-t-il accès à des renseignements ou à des biens COMSEC désignés PROTÉGÉS et/ou CLASSIFIÉS? No / Non Yes / Oui
If Yes, indicate the level of sensitivity:
Dans l'affirmative, indiquer le niveau de sensibilité :

9. Will the supplier require access to extremely sensitive INFOSEC information or assets?
Le fournisseur aura-t-il accès à des renseignements ou à des biens INFOSEC de nature extrêmement délicate? No / Non Yes / Oui

Short Title(s) of material / Titre(s) abrégé(s) du matériel :
Document Number / Numéro du document :

PART B PERSONNEL (SUPPLIER) / PARTIE B PERSONNEL (FOURNISSEUR)

10. a) Personnel security screening level required / Niveau de contrôle de la sécurité du personnel requis

<input checked="" type="checkbox"/> RELIABILITY STATUS COTE DE FIABILITÉ	<input type="checkbox"/> CONFIDENTIAL CONFIDENTIEL	<input type="checkbox"/> SECRET SECRET	<input type="checkbox"/> TOP SECRET TRÈS SECRET
<input type="checkbox"/> TOP SECRET - SIGINT TRÈS SECRET - SIGINT	<input type="checkbox"/> NATO CONFIDENTIAL NATO CONFIDENTIEL	<input type="checkbox"/> NATO SECRET NATO SECRET	<input type="checkbox"/> COSMIC TOP SECRET COSMIC TRÈS SECRET
<input type="checkbox"/> SITE ACCESS ACCÈS AUX EMPLACEMENTS			

Special comments:
Commentaires spéciaux :

NOTE: If multiple levels of screening are identified, a Security Classification Guide must be provided.
REMARQUE : Si plusieurs niveaux de contrôle de sécurité sont requis, un guide de classification de la sécurité doit être fourni.

10. b) May unscreened personnel be used for portions of the work?
Du personnel sans autorisation sécuritaire peut-il se voir confier des parties du travail? No / Non Yes / Oui
If Yes, will unscreened personnel be escorted?
Dans l'affirmative, le personnel en question sera-t-il escorté? No / Non Yes / Oui

PART C SAFEGUARDS (SUPPLIER) / PARTIE C MESURES DE PROTECTION (FOURNISSEUR)

INFORMATION / ASSETS / RENSEIGNEMENTS / BIENS

11. a) Will the supplier be required to receive and store PROTECTED and/or CLASSIFIED information or assets on its site or premises?
Le fournisseur sera-t-il tenu de recevoir et d'entreposer sur place des renseignements ou des biens PROTÉGÉS et/ou CLASSIFIÉS? No / Non Yes / Oui

11. b) Will the supplier be required to safeguard COMSEC information or assets?
Le fournisseur sera-t-il tenu de protéger des renseignements ou des biens COMSEC? No / Non Yes / Oui

PRODUCTION

11. c) Will the production (manufacture, and/or repair and/or modification) of PROTECTED and/or CLASSIFIED material or equipment occur at the supplier's site or premises?
Les installations du fournisseur serviront-elles à la production (fabrication et/ou réparation et/ou modification) de matériel PROTÉGÉ et/ou CLASSIFIÉ? No / Non Yes / Oui

INFORMATION TECHNOLOGY (IT) MEDIA / SUPPORT RELATIF À LA TECHNOLOGIE DE L'INFORMATION (TI)

11. d) Will the supplier be required to use its IT systems to electronically process, produce or store PROTECTED and/or CLASSIFIED information or data?
Le fournisseur sera-t-il tenu d'utiliser ses propres systèmes informatiques pour traiter, produire ou stocker électroniquement des renseignements ou des données PROTÉGÉS et/ou CLASSIFIÉS? No / Non Yes / Oui

11. e) Will there be an electronic link between the supplier's IT systems and the government department or agency?
Disposera-t-on d'un lien électronique entre le système informatique du fournisseur et celui du ministère ou de l'agence gouvernementale? No / Non Yes / Oui



Contract Number / Numéro du contrat
Security Classification / Classification de sécurité

PART C - (continued) / PARTIE C - (suite)

For users completing the form manually use the summary chart below to indicate the category(ies) and level(s) of safeguarding required at the supplier's site(s) or premises.

Les utilisateurs qui remplissent le formulaire manuellement doivent utiliser le tableau récapitulatif ci-dessous pour indiquer, pour chaque catégorie, les niveaux de sauvegarde requis aux installations du fournisseur.

For users completing the form online (via the Internet), the summary chart is automatically populated by your responses to previous questions.

Dans le cas des utilisateurs qui remplissent le formulaire en ligne (par Internet), les réponses aux questions précédentes sont automatiquement saisies dans le tableau récapitulatif.

SUMMARY CHART / TABLEAU RÉCAPITULATIF

Category / Catégorie	PROTECTED / PROTÉGÉ			CLASSIFIED / CLASSIFIÉ			NATO				COMSEC					
	A	B	C	CONFIDENTIAL / CONFIDENTIEL	SECRET	TOP SECRET / TRÈS SECRET	NATO RESTRICTED / NATO DIFFUSION RESTREINTE	NATO CONFIDENTIAL / NATO CONFIDENTIEL	NATO SECRET	COSMIC TOP SECRET / COSMIC TRÈS SECRET	PROTECTED / PROTÉGÉ			CONFIDENTIAL / CONFIDENTIEL	SECRET	TOP SECRET / TRÈS SECRET
											A	B	C			
Information / Assets / Renseignements / Biens / Production	<input type="checkbox"/>	<input type="checkbox"/>	<input type="checkbox"/>	<input type="checkbox"/>	<input type="checkbox"/>	<input type="checkbox"/>	<input type="checkbox"/>	<input type="checkbox"/>	<input type="checkbox"/>	<input type="checkbox"/>	<input type="checkbox"/>	<input type="checkbox"/>	<input type="checkbox"/>	<input type="checkbox"/>	<input type="checkbox"/>	<input type="checkbox"/>
IT Media / Support TI	<input type="checkbox"/>	<input type="checkbox"/>	<input type="checkbox"/>	<input type="checkbox"/>	<input type="checkbox"/>	<input type="checkbox"/>	<input type="checkbox"/>	<input type="checkbox"/>	<input type="checkbox"/>	<input type="checkbox"/>	<input type="checkbox"/>	<input type="checkbox"/>	<input type="checkbox"/>	<input type="checkbox"/>	<input type="checkbox"/>	<input type="checkbox"/>
IT Link / Lien électronique	<input type="checkbox"/>	<input type="checkbox"/>	<input type="checkbox"/>	<input type="checkbox"/>	<input type="checkbox"/>	<input type="checkbox"/>	<input type="checkbox"/>	<input type="checkbox"/>	<input type="checkbox"/>	<input type="checkbox"/>	<input type="checkbox"/>	<input type="checkbox"/>	<input type="checkbox"/>	<input type="checkbox"/>	<input type="checkbox"/>	<input type="checkbox"/>

12. a) Is the description of the work contained within this SRCL PROTECTED and/or CLASSIFIED? No / Non Yes / Oui

La description du travail visé par la présente LVERS est-elle de nature PROTÉGÉE et/ou CLASSIFIÉE?

If Yes, classify this form by annotating the top and bottom in the area entitled "Security Classification".
 Dans l'affirmative, classifiez le présent formulaire en indiquant le niveau de sécurité dans la case intitulée « Classification de sécurité » au haut et au bas du formulaire.

12. b) Will the documentation attached to this SRCL be PROTECTED and/or CLASSIFIED? No / Non Yes / Oui

La documentation associée à la présente LVERS sera-t-elle PROTÉGÉE et/ou CLASSIFIÉE?

If Yes, classify this form by annotating the top and bottom in the area entitled "Security Classification" and indicate with attachments (e.g. SECRET with Attachments).
 Dans l'affirmative, classifiez le présent formulaire en indiquant le niveau de sécurité dans la case intitulée « Classification de sécurité » au haut et au bas du formulaire et indiquez qu'il y a des pièces jointes (p. ex. SECRET avec des pièces jointes).



Contract Number / Numéro du contrat
Security Classification / Classification de sécurité

PARTIE D'AUTORISATION / PARTIE D'AUTORISATION			
13. Organization Project Authority / Chargé de projet de l'organisme			
Name (print) - Nom (en lettres moulées) Martin Legris		Title - Titre Chef de service- Bâtiment	Signature
Telephone No. - N° de téléphone 450-641-5248	Facsimile No. - N° de télécopieur 450-641-5253	E-mail address - Adresse courriel martin.legris@cnrc-nrc.gc.ca	Date 23 juin 2015
14. Organization Security Authority / Responsable de la sécurité de l'organisme			
Name (print) - Nom (en lettres moulées) CHARLOTTE GAGNON		Title - Titre Security in CONTRACTS	Signature
Telephone No. - N° de téléphone 613 993-8956	Facsimile No. - N° de télécopieur 613 990-0946	E-mail address - Adresse courriel charlotte.gagnon@cnrc-nrc.gc.ca	Date 25 JUN 2015
15. Are there additional instructions (e.g. Security Guide, Security Classification Guide) attached? Des instructions supplémentaires (p. ex. Guide de sécurité, Guide de classification de la sécurité) sont-elles jointes?			
			<input type="checkbox"/> No / <input type="checkbox"/> Yes <input type="checkbox"/> Non / <input type="checkbox"/> Oui
16. Procurement Officer / Agent d'approvisionnement			
Name (print) - Nom (en lettres moulées) M. BEDARD		Title - Titre Senior Contracts Officer	Signature
Telephone No. - N° de téléphone 613 993-2274	Facsimile No. - N° de télécopieur	E-mail address - Adresse courriel	Date 21/6/15
17. Contracting Security Authority / Autorité contractante en matière de sécurité			
Name (print) - Nom (en lettres moulées)		Title - Titre	Signature
Telephone No. - N° de téléphone	Facsimile No. - N° de télécopieur	E-mail address - Adresse courriel	Date



Contract Number / Numéro du contrat
Security Classification / Classification de sécurité

SECURITY REQUIREMENTS CHECK LIST (SRCL)
LISTE DE VÉRIFICATION DES EXIGENCES RELATIVES À LA SÉCURITÉ (LVERS)

PART A - CONTRACT INFORMATION / PARTIE A - INFORMATION CONTRACTUELLE

1. Originating Government Department or Organization / Ministère ou organisme gouvernemental d'origine Conseil National de Recherche du Canada	2. Branch or Directorate / Direction générale ou Direction SAGI- Boucherville
--	--

3. a) Subcontract Number / Numéro du contrat de sous-traitance	3. b) Name and Address of Subcontractor / Nom et adresse du sous-traitant
--	---

4. Brief Description of Work / Brève description du travail
 Réfection de la toiture secteur entrepôt

5. a) Will the supplier require access to Controlled Goods?
 Le fournisseur aura-t-il accès à des marchandises contrôlées? No / Non Yes / Oui

5. b) Will the supplier require access to unclassified military technical data subject to the provisions of the Technical Data Control Regulations?
 Le fournisseur aura-t-il accès à des données techniques militaires non classifiées qui sont assujetties aux dispositions du Règlement sur le contrôle des données techniques? No / Non Yes / Oui

6. Indicate the type of access required / Indiquer le type d'accès requis

6. a) Will the supplier and its employees require access to PROTECTED and/or CLASSIFIED information or assets?
 Le fournisseur ainsi que les employés auront-ils accès à des renseignements ou à des biens PROTÉGÉS et/ou CLASSIFIÉS? (Specify the level of access using the chart in Question 7. c) (Préciser le niveau d'accès en utilisant le tableau qui se trouve à la question 7. c) No / Non Yes / Oui

6. b) Will the supplier and its employees (e.g. cleaners, maintenance personnel) require access to restricted access areas? No access to PROTECTED and/or CLASSIFIED information or assets is permitted.
 Le fournisseur et ses employés (p. ex. nettoyeurs, personnel d'entretien) auront-ils accès à des zones d'accès restreintes? L'accès à des renseignements ou à des biens PROTÉGÉS et/ou CLASSIFIÉS n'est pas autorisé. No / Non Yes / Oui

6. c) Is this a commercial courier or delivery requirement with no overnight storage?
 S'agit-il d'un contrat de messagerie ou de livraison commerciale sans entreposage de nuit? No / Non Yes / Oui

7. a) Indicate the type of information that the supplier will be required to access / Indiquer le type d'information auquel le fournisseur devra avoir accès

Canada <input checked="" type="checkbox"/>	NATO / OTAN <input type="checkbox"/>	Foreign / Étranger <input type="checkbox"/>
--	--------------------------------------	---

7. b) Release restrictions / Restrictions relatives à la diffusion

No release restrictions / Aucune restriction relative à la diffusion <input type="checkbox"/>	All NATO countries / Tous les pays de l'OTAN <input type="checkbox"/>	No release restrictions / Aucune restriction relative à la diffusion <input type="checkbox"/>
Not releasable / À ne pas diffuser <input type="checkbox"/>		
Restricted to: / Limité à: Specify country(ies): / Préciser le(s) pays: <input type="checkbox"/>	Restricted to: / Limité à: Specify country(ies): / Préciser le(s) pays: <input type="checkbox"/>	Restricted to: / Limité à: Specify country(ies): / Préciser le(s) pays: <input type="checkbox"/>

7. c) Level of information / Niveau d'information

PROTECTED A / PROTÉGÉ A <input type="checkbox"/>	NATO UNCLASSIFIED / NATO NON CLASSIFIÉ <input type="checkbox"/>	PROTECTED A / PROTÉGÉ A <input type="checkbox"/>
PROTECTED B / PROTÉGÉ B <input type="checkbox"/>	NATO RESTRICTED / NATO DIFFUSION RESTREINTE <input type="checkbox"/>	PROTECTED B / PROTÉGÉ B <input type="checkbox"/>
PROTECTED C / PROTÉGÉ C <input type="checkbox"/>	NATO CONFIDENTIAL / NATO CONFIDENTIEL <input type="checkbox"/>	PROTECTED C / PROTÉGÉ C <input type="checkbox"/>
CONFIDENTIAL / CONFIDENTIEL <input type="checkbox"/>	NATO SECRET <input type="checkbox"/>	CONFIDENTIAL / CONFIDENTIEL <input type="checkbox"/>
SECRET / SECRET <input type="checkbox"/>	COSMIC TOP SECRET / COSMIC TRÈS SECRET <input type="checkbox"/>	SECRET / SECRET <input type="checkbox"/>
TOP SECRET / TRÈS SECRET <input type="checkbox"/>		TOP SECRET / TRÈS SECRET <input type="checkbox"/>
TOP SECRET (SIGINT) / TRÈS SECRET (SIGINT) <input type="checkbox"/>		TOP SECRET (SIGINT) / TRÈS SECRET (SIGINT) <input type="checkbox"/>



Contract Number / Numéro du contrat
Security Classification / Classification de sécurité

PARTIE A (continued) / PARTIE A (suite)

8. Will the supplier require access to PROTECTED and/or CLASSIFIED COMSEC information or assets?
 Le fournisseur aura-t-il accès à des renseignements ou à des biens COMSEC désignés PROTÉGÉS et/ou CLASSIFIÉS? No / Non Yes / Oui
 If Yes, indicate the level of sensitivity:
 Dans l'affirmative, indiquer le niveau de sensibilité :

9. Will the supplier require access to extremely sensitive INFOSEC information or assets?
 Le fournisseur aura-t-il accès à des renseignements ou à des biens INFOSEC de nature extrêmement délicate? No / Non Yes / Oui

Short Title(s) of material / Titre(s) abrégé(s) du matériel :
 Document Number / Numéro du document :

PARTIE B PERSONNEL (SUPPLIERS) / PARTIE B PERSONNEL (FOURNISSEUR)

10. a) Personnel security screening level required / Niveau de contrôle de la sécurité du personnel requis

<input checked="" type="checkbox"/> RELIABILITY STATUS COTE DE FIABILITÉ	<input type="checkbox"/> CONFIDENTIAL CONFIDENTIEL	<input type="checkbox"/> SECRET SECRET	<input type="checkbox"/> TOP SECRET TRÈS SECRET
<input type="checkbox"/> TOP SECRET-SIGINT TRÈS SECRET - SIGINT	<input type="checkbox"/> NATO CONFIDENTIAL NATO CONFIDENTIEL	<input type="checkbox"/> NATO SECRET NATO SECRET	<input type="checkbox"/> COSMIC TOP SECRET COSMIC TRÈS SECRET
<input type="checkbox"/> SITE ACCESS ACCÈS AUX EMPLACEMENTS			

Special comments:
 Commentaires spéciaux : _____

NOTE: If multiple levels of screening are identified, a Security Classification Guide must be provided.
 REMARQUE : Si plusieurs niveaux de contrôle de sécurité sont requis, un guide de classification de la sécurité doit être fourni.

10. b) May unscreened personnel be used for portions of the work?
 Du personnel sans autorisation sécuritaire peut-il se voir confier des parties du travail? No / Non Yes / Oui
 If Yes, will unscreened personnel be escorted?
 Dans l'affirmative, le personnel en question sera-t-il escorté? No / Non Yes / Oui

PARTIE C SAFEGUARDS (SUPPLIER) / PARTIE C MESURES DE PROTECTION (FOURNISSEUR)

INFORMATION / ASSETS / RENSEIGNEMENTS / BIENS

11. a) Will the supplier be required to receive and store PROTECTED and/or CLASSIFIED information or assets on its site or premises?
 Le fournisseur sera-t-il tenu de recevoir et d'entreposer sur place des renseignements ou des biens PROTÉGÉS et/ou CLASSIFIÉS? No / Non Yes / Oui

11. b) Will the supplier be required to safeguard COMSEC information or assets?
 Le fournisseur sera-t-il tenu de protéger des renseignements ou des biens COMSEC? No / Non Yes / Oui

PRODUCTION

11. c) Will the production (manufacture, and/or repair and/or modification) of PROTECTED and/or CLASSIFIED material or equipment occur at the supplier's site or premises?
 Les installations du fournisseur serviront-elles à la production (fabrication et/ou réparation et/ou modification) de matériel PROTÉGÉ et/ou CLASSIFIÉ? No / Non Yes / Oui

INFORMATION TECHNOLOGY (IT) MEDIA / SUPPORT RELATIF À LA TECHNOLOGIE DE L'INFORMATION (TI)

11. d) Will the supplier be required to use its IT systems to electronically process, produce or store PROTECTED and/or CLASSIFIED information or data?
 Le fournisseur sera-t-il tenu d'utiliser ses propres systèmes informatiques pour traiter, produire ou stocker électroniquement des renseignements ou des données PROTÉGÉS et/ou CLASSIFIÉS? No / Non Yes / Oui

11. e) Will there be an electronic link between the supplier's IT systems and the government department or agency?
 Disposera-t-on d'un lien électronique entre le système informatique du fournisseur et celui du ministère ou de l'agence gouvernementale? No / Non Yes / Oui



Contract Number / Numéro du contrat
Security Classification / Classification de sécurité

PART C - (continued) / PARTIE C - (suite)

For users completing the form manually use the summary chart below to indicate the category(ies) and level(s) of safeguarding required at the supplier's site(s) or premises.
 Les utilisateurs qui remplissent le formulaire manuellement doivent utiliser le tableau récapitulatif ci-dessous pour indiquer, pour chaque catégorie, les niveaux de sauvegarde requis aux installations du fournisseur.

For users completing the form online (via the Internet), the summary chart is automatically populated by your responses to previous questions.
 Dans le cas des utilisateurs qui remplissent le formulaire en ligne (par Internet), les réponses aux questions précédentes sont automatiquement saisies dans le tableau récapitulatif.

SUMMARY CHART / TABLEAU RÉCAPITULATIF

Category / Catégorie	PROTECTED / PROTÉGÉ			CLASSIFIED / CLASSIFIÉ			NATO				COMSEC					
	A	B	C	CONFIDENTIAL / CONFIDENTIEL	SECRET	TOP SECRET / TRÈS SECRET	NATO RESTRICTED / NATO DIFFUSION RESTREINTE	NATO CONFIDENTIAL / NATO CONFIDENTIEL	NATO SECRET	COSMIC TOP SECRET / COSMIC TRÈS SECRET	PROTECTED / PROTÉGÉ			CONFIDENTIAL / CONFIDENTIEL	SECRET	TOP SECRET / TRÈS SECRET
											A	B	C			
Information / Assets / Renseignements / Biens	<input type="checkbox"/>	<input type="checkbox"/>	<input type="checkbox"/>	<input type="checkbox"/>	<input type="checkbox"/>	<input type="checkbox"/>	<input type="checkbox"/>	<input type="checkbox"/>	<input type="checkbox"/>	<input type="checkbox"/>	<input type="checkbox"/>	<input type="checkbox"/>	<input type="checkbox"/>	<input type="checkbox"/>	<input type="checkbox"/>	<input type="checkbox"/>
Production	<input type="checkbox"/>	<input type="checkbox"/>	<input type="checkbox"/>	<input type="checkbox"/>	<input type="checkbox"/>	<input type="checkbox"/>	<input type="checkbox"/>	<input type="checkbox"/>	<input type="checkbox"/>	<input type="checkbox"/>	<input type="checkbox"/>	<input type="checkbox"/>	<input type="checkbox"/>	<input type="checkbox"/>	<input type="checkbox"/>	<input type="checkbox"/>
IT Media / Support TI	<input type="checkbox"/>	<input type="checkbox"/>	<input type="checkbox"/>	<input type="checkbox"/>	<input type="checkbox"/>	<input type="checkbox"/>	<input type="checkbox"/>	<input type="checkbox"/>	<input type="checkbox"/>	<input type="checkbox"/>	<input type="checkbox"/>	<input type="checkbox"/>	<input type="checkbox"/>	<input type="checkbox"/>	<input type="checkbox"/>	<input type="checkbox"/>
IT Link / Lien électronique	<input type="checkbox"/>	<input type="checkbox"/>	<input type="checkbox"/>	<input type="checkbox"/>	<input type="checkbox"/>	<input type="checkbox"/>	<input type="checkbox"/>	<input type="checkbox"/>	<input type="checkbox"/>	<input type="checkbox"/>	<input type="checkbox"/>	<input type="checkbox"/>	<input type="checkbox"/>	<input type="checkbox"/>	<input type="checkbox"/>	<input type="checkbox"/>

12. a) Is the description of the work contained within this SRCL PROTECTED and/or CLASSIFIED?
 La description du travail visé par la présente LVERS est-elle de nature PROTÉGÉE et/ou CLASSIFIÉE? No / Non Yes / Oui

If Yes, classify this form by annotating the top and bottom in the area entitled "Security Classification".
 Dans l'affirmative, classifiez le présent formulaire en indiquant le niveau de sécurité dans la case intitulée « Classification de sécurité » au haut et au bas du formulaire.

12. b) Will the documentation attached to this SRCL be PROTECTED and/or CLASSIFIED?
 La documentation associée à la présente LVERS sera-t-elle PROTÉGÉE et/ou CLASSIFIÉE? No / Non Yes / Oui

If Yes, classify this form by annotating the top and bottom in the area entitled "Security Classification" and indicate with attachments (e.g. SECRET with Attachments).
 Dans l'affirmative, classifiez le présent formulaire en indiquant le niveau de sécurité dans la case intitulée « Classification de sécurité » au haut et au bas du formulaire et indiquez qu'il y a des pièces jointes (p. ex. SECRET avec des pièces jointes).



Government of Canada / Gouvernement du Canada

Contract Number / Numéro du contrat
Security Classification / Classification de sécurité

PARTIE D'AUTORISATION / PARTIE D'AUTORISATION			
13. Organization Project Authority / Chargé de projet de l'organisme			
Name (print) - Nom (en lettres moulées) Martin Legris		Title - Titre Chef de service- Bâtiment	Signature
Telephone No. - N° de téléphone 450-641-5248	Facsimile No. - N° de télécopieur 450-641-5253	E-mail address - Adresse courriel martin.legris@cnrc-nrc.gc.ca	Date 23 juin 2015
14. Organization Security Authority / Responsable de la sécurité de l'organisme			
Name (print) - Nom (en lettres moulées) CHARLOTTE CARRIER		Title - Titre Security in Contracts	Signature
Telephone No. - N° de téléphone 613 993-8954	Facsimile No. - N° de télécopieur 613 990-0946	E-mail address - Adresse courriel charlotte.cARRIER@NRC-CNRC.gc.ca	Date 25 JUN 2015
15. Are there additional instructions (e.g. Security Guide, Security Classification Guide) attached? Des instructions supplémentaires (p. ex. Guide de sécurité, Guide de classification de la sécurité) sont-elles jointes?			<input type="checkbox"/> No / Non <input type="checkbox"/> Yes / Oui
16. Procurement Officer / Agent d'approvisionnement			
Name (print) - Nom (en lettres moulées) MBEDARD		Title - Titre Senior Contracting Officer	Signature
Telephone No. - N° de téléphone 613 993 2274	Facsimile No. - N° de télécopieur	E-mail address - Adresse courriel	Date 2/6/15
17. Contracting Security Authority / Autorité contractante en matière de sécurité			
Name (print) - Nom (en lettres moulées)		Title - Titre	Signature
Telephone No. - N° de téléphone	Facsimile No. - N° de télécopieur	E-mail address - Adresse courriel	Date

GÉNÉRALITÉS

- AVANT DE COMMENCER LES TRAVAUX VÉRIFIER LES MESURES SUR PLACE ET EN CAS D'ERREUR COMMUNIQUER IMMÉDIATEMENT EN AVERTISSANT LE REPRÉSENTANT MINISTÉRIEL.
- EXAMINER ATTENTIVEMENT LE SITE DES TRAVAUX ET SE FAMILIARISER PLEINEMENT AVEC LEUR ÉTENDUE.
- CONTENIR LA POUSSIÈRE ET LES DÉBRIS DANS LE PÉRIMÈTRE DES TRAVAUX ET UNE FOIS TERMINÉS, NETTOYER LES SURFACES SOULÉES.
- RAGREER TOUTES LES SURFACES ABIMÉES PAR LE FAIT DES TRAVAUX.
- COORDONNER TOUTES LES INTERRUPTIONS DE SERVICES AVEC LE REPRÉSENTANT MINISTÉRIEL.
- FOURNIR ET INSTALLER TOUS LES MATÉRIAUX ET LA MAIN D'ŒUVRE REQUIS POUR PARFAIRE LES OUVRAGES DÉCRITS DANS LES DOCUMENTS CONTRACTUELS.

PLAN CLÉ

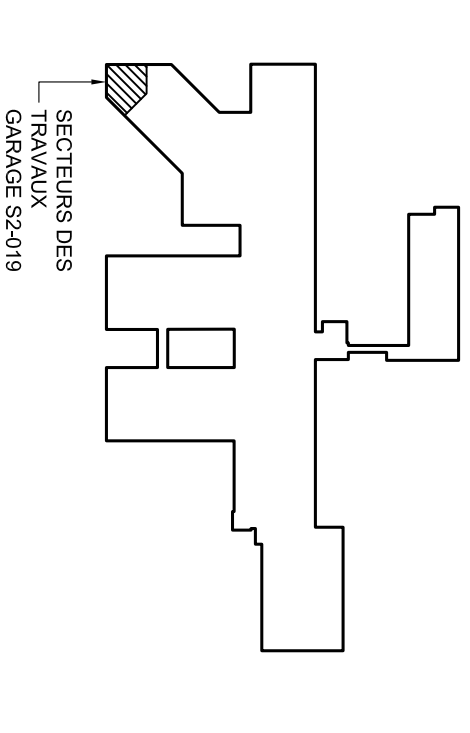

FAUCHER GAUTHIER
 architectes inc.

133, rue Saint-Georges
 Québec, Québec G1K 0P3
 Tél. 819 472 0399
 Fax 819 472 6817
 www.fauchergauthier.com

No.	Date	Révision	Date imprimée
1	2014-12-09	DMS POUR COMMENTAIRES	
2	2014-01-20	DMS POUR COMMENTAIRES	
3	2014-01-23	DMS POUR COMMENTAIRES	

o Verify all dimensions and site conditions and be responsible for same
 o Vérifier toutes les dimensions et l'état des lieux et en assumer la responsabilité

project: **NOUVELLE ESCALIER D'ACCÈS AU TOIT**
 IM. BOUCHERVILLE

drawing: **PLAN D'AMÉNAGEMENT D'UNE NOUVELLE ESCALIER**

designed	compil	date	date
M.F.	M.F.	DECEMBRE 2014	
drawn	dessiné	scale	échelle
F.B.	F.B.	INDOUEE	
checked	vérifié	sheet	feuille
M.F.	M.F.	A1	2
approved	approuvé	W.O.no.	D.T.no.
M.F.	M.F.		

dwg.no. **14125**

NOTES GÉNÉRALES

- AVOIR ÉMIS L'ORDRE CONTRAIRE AUX DOCUMENTS, LE TERME "FOURNIR" COMPREND ÉGALEMENT L'INSTALLATION ET LE RACCORDEMENT ET LE TERME "INSTALLER" COMPREND ÉGALEMENT LA FOURNITURE.
- EN PRÉPARANT LA SOUMISSION, CONSULTER TOUTS LES PLANS ET DÉTAILS ET VÉRIFIER TOUTES LES SECTIONS QUI PEUVENT INFLUER SUR LES TRAVAUX.
- L'ENTREPRENEUR DOIT FOURNIR LES MATÉRIAUX, LA MAIN D'ŒUVRE ET LES Outils NECESSAIRES POUR AVOIR UNE INSTALLATION COMPLÈTE.
- FAIRE LA COORDINATION DES TRAVAUX AVEC CEUX DES AUTRES TRAVAUX DÉCRITS AU PRÉSENT CHAPITRE DE PLANS INCLUANTS CEUX QUI NE SONT PAS NECESSAIREMENT MENTIONNÉS ICI, MAIS QUI SONT JUGÉS NECESSAIRES POUR AVOIR UNE INSTALLATION COMPLÈTE.
- LES PLANS SONT MONTRES DE FAÇON SÉPARÉE TOUS LES INDIVIDUENT RACCORDEMENTS, L'ENTREPRENEUR DEVRA FAIRE LES INSTALLATIONS EN FONCTION DE L'EXISTANT ET SELON LES DÉTAILS FOURNIS. LE TRAVAIL DE DÉMOLITION NE DOIT PAS ÊTRE DÉMARRÉ AVANT DE CONSULTER LES PLANS ET LES DÉTAILS. AVANT DE COMMENCER LES TRAVAUX, LE TRAVAIL DE DÉMOLITION NE DOIT PAS ÊTRE DÉMARRÉ AVANT DE CONSULTER LES PLANS ET LES DÉTAILS. AVANT DE COMMENCER LES TRAVAUX, LE TRAVAIL DE DÉMOLITION NE DOIT PAS ÊTRE DÉMARRÉ AVANT DE CONSULTER LES PLANS ET LES DÉTAILS.
- TOUTS LES TRAVAUX DÉCRITS SUR LES PLANS DEVONT ÊTRE EN VIGUEUR ANSI QU'EN CAS DE DIFFÉRENTS LOIS ET DES RÈGLEMENTS MUNICIPAUX ET PROVINCIAUX.
- PRÉVOIR TOUT LES RAGRÈGES DE SURFACES REQUIS SUITE AUX TRAVAUX DE DÉMOLITION ET/OU CONSTRUCTION DE MURS, PLAFONDS, ÉQUIPEMENTS OU AUTRES ÉLÉMENTS DU PRÉSENT MANUEL.
- PRÉVOIR AU PRÉSENT CONTRAT UN NETTOYAGE COMPLET ET EN PROFONDEUR DES LIEUX TOUCHÉS ET/OU À LA S'IMPACTATION DU PROPRÉTAIRE.
- L'ENTREPRENEUR DOIT INCLURE À SA RESPONSABILITÉ LA CONSTRUCTION DE TOUTS LES MURS TEMPORAIRES REQUIS ENTRE LES DIFFÉRENTES PHASES ET POUR AUTRES INSTALLATIONS TEMPORAIRES. LES COUSONS DOIVENT ÊTRE RETENUS SEULEMENT UNE FOIS LE NETTOYAGE FINAL ÉFFECTUÉ.
- COORDONNER L'EMPLACEMENT DES CONTENNEURS À DÉCHETS SUR PLACE AVEC LE CLIENT.

NOTES REAMÉNAGEMENT

- L'ENTREPRENEUR DEVOIT VÉRIFIER ET VALIDER TOUTES LES MESURES SUR PLACE AVANT L'ÉCARTION DES TRAVAUX.
- L'ENTREPRENEUR EST RESPONSABLE DE RAGREER LES REBUTS DE DÉMOLITION DE CONSTRUCTION COMME IL EST DÉCRIT DANS LE RÈGLEMENT PROVINCIAL. LES REBUTS DEVONT ÊTRE DÉPOSÉS DANS UN SITE DE MATÉRIAUX SECS POSÉDANT UNE CERTAINE CAPACITÉ DE STOCKAGE.
- L'ENTREPRENEUR EST RESPONSABLE DE RAGREER ET/OU RÉMETTRE LES TRAVAUX POUVANT ÊTRE ENDOMMAGÉS PAR LES TRAVAUX: MURS, PLAFONDS, PLANCHERS, CONTRÔLES MÉCANIQUE, ÉLECTRIQUE ETC.

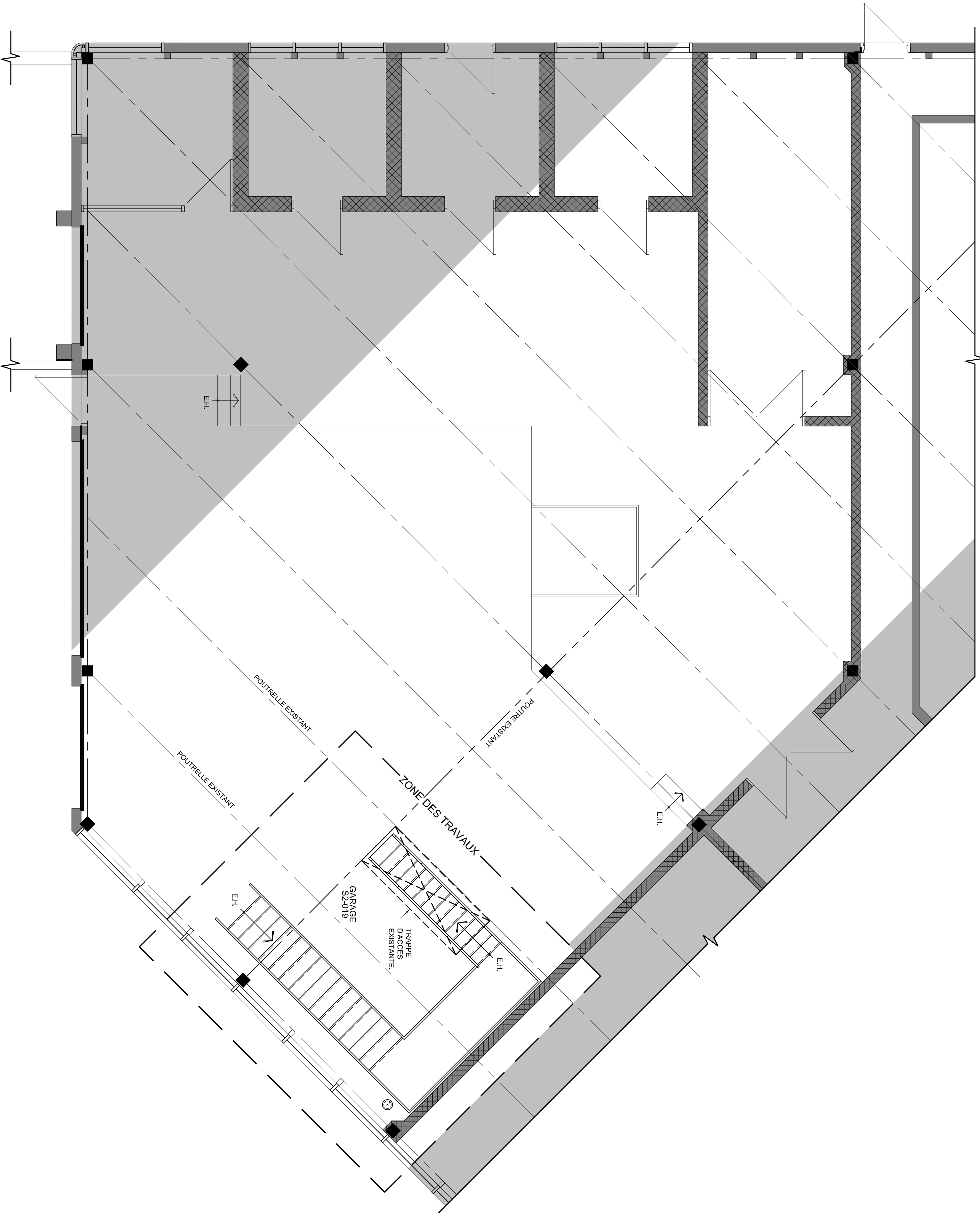

PLAN D'AMÉNAGEMENT D'UNE NOUVELLE ESCALIER
 ÉCHELLE : 1:50

RCBC - CNRC

GÉNÉRALITÉS

- AVANT DE COMMENCER LES TRAVAUX VÉRIFIER LES MESURES SUR PLACE ET EN CAS D'ERREUR SUR LES MESURES EN AVANT LE REPRÉSENTANT MINISTÉRIEL.
- EXAMINER ATTENTIVEMENT LE SITE DES TRAVAUX ET SE FAMILIARISER PIÈCEMENT AVEC LEUR ÉTENDUE.
- CONTENU LA POUSSIÈRE ET LES DÉBRIS DANS LE PÉRIMÈTRE DES TRAVAUX ET UNE FOIS TERMINÉS, NETTOYER LES SURFACES SOULÉVÉS.
- RAGREER TOUTES LES SURFACES ABIMÉES PAR LE FAIT DES TRAVAUX.
- COORDONNER TOUTES LES INTERRUPTIONS DE SERVICES AVEC LE REPRÉSENTANT MINISTÉRIEL.
- FOURNIR ET INSTALLER TOUS LES MATÉRIAUX ET LA MAIN D'ŒUVRE REQUIS POUR PARFAIRE LES OUVRAGES DÉCRITS DANS LES DOCUMENTS CONTRACTUELS.

FAUCHER GAUTHIER
 architectes inc.

133, rue Saint-Georges
 Québec, Québec G1K 0P3
 Tél. 813 472 0399
 Tél. 813 472 6817
 Fax 813 472 6817
 www.fauchergauthier.com

PLAN CLÉ

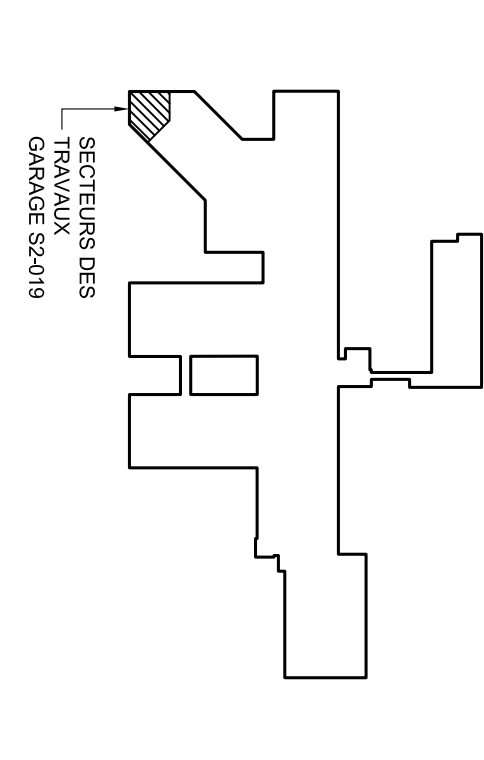

No.	Date	Revision	Date imprimée
1	2014-12-20	DMS POUR COMMENTAIRES	F.B.
2	2014-03-20	DMS POUR COMMENTAIRES	F.B.
3	2014-03-23	DMS POUR COMMENTAIRES	F.B.

o Verify all dimensions and site conditions and be responsible for same
 o Vérifier toutes les dimensions et l'état des lieux et en assumer la responsabilité

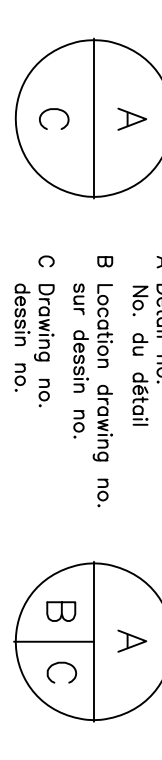

project: **NOUVELLE ESCALIER D'ACCÈS AU TOIT**
 IM. BOUCHERVILLE

drawing: **PLAN DE L'ESCALIER COUPE D'ESCALIER DETAILS TYPES**

designed / conçu	date / date	scale / échelle
M.F.	DECEMBRE 2014	
F.B.	INDOUEE	
M.F.	sheet / feuille	A2 of / de 2
approved / approuvé	W.O. no.	D.T. no.
M.F.		

drawn / dessiné: **14125**

- #### NOTES GÉNÉRALE ET ESCALIER
- VÉRIFIER ET TENER COMPTE DES DIMENSIONS SUR PLACE AVANT LA FABRICATION DE L'ESCALIER.
 - PRENDRE L'ENSEMBLE DES RENFORTS NECESSAIRES POUR GARDE-CORPS, ASSURER LA SOLIDITE DE L'ENSEMBLE.
 - POUR L'ENSEMBLE DES SOUS-ŒUVRES DE L'ASSEMBLAGE DE FAÇON À CE QUE LES JOINTURES DES ÉLÉMENTS D'ACIER SOIENT SANS SAUVURES.
 - TOUTES LES COMPOSANTES DE L'ESCALIER, GARDE-CORPS ET MAIN-COURANTES DEVONT ÊTRE EN ACIER AVANT REÇU UN APPRÊT EN USINE.
 - L'ENSEMBLE DES ÉLÉMENTS D'ACIER COMPOSANT L'ESCALIER DEVONT ÊTRE PEINT COORDONNÉ LE CHOIX DES COULEURS AVEC LE PROJET/ARCHITECTE.
 - S'ASSURER QUE L'ENSEMBLE DES ÉLÉMENTS D'ACIER SONT FINISSE ET TUNÉ COMME AUCUNE ÉGRAIGNURE, SAUF CE QUI NECESSAIRE SANS VOULTEUR.
 - COORDONNER LA MASSE EN VUE DE L'ENSEMBLE DES ASSURER LA SOLIDITE DE L'ENSEMBLE DES ASSEMBLAGES D'ACIER, AINSI QU'OSILLEMENT DANS LA STRUCTURE NE SERA TOUJOURS.
- #### ESCALIER PLAQUE D'ACIER PUEE
- LIMON:
 - MC 250 x 125 PREVOIR PLAQUE D'ACIER DE TYPE EN COBRE ALU (OUI L'ÉLÉMENT).
 - MARCHÉ ET CONTRE-MARCHÉ:
 - PLAQUE D'ACIER PUEE 6mm Dpa, DE TYPE ANTIDÉBRAYANTE AVEC ESTAMPAGE DIAMANT.
 - MAIN COURANTE:
 - TOUTAUX ROND 38mm DIA. EN ACIER PUEE AU MINIMUM 150mm DE LONGUEUR PAR MARCHÉ. ASSURER LA SOLIDITE DE L'ENSEMBLE AVEC FIXATION AU MUR @ 150mm de max.
 - GARDE-CORPS:
 - 3 TOUTAUX ROND HORIZONTAL 38mm DIA. @ DISTANCE VERTICALE 380mm @ 150mm MAX.
 - ASSURER LA SOLIDITE DE L'ENSEMBLE AVEC FIXATION AU MUR @ 150mm de max.

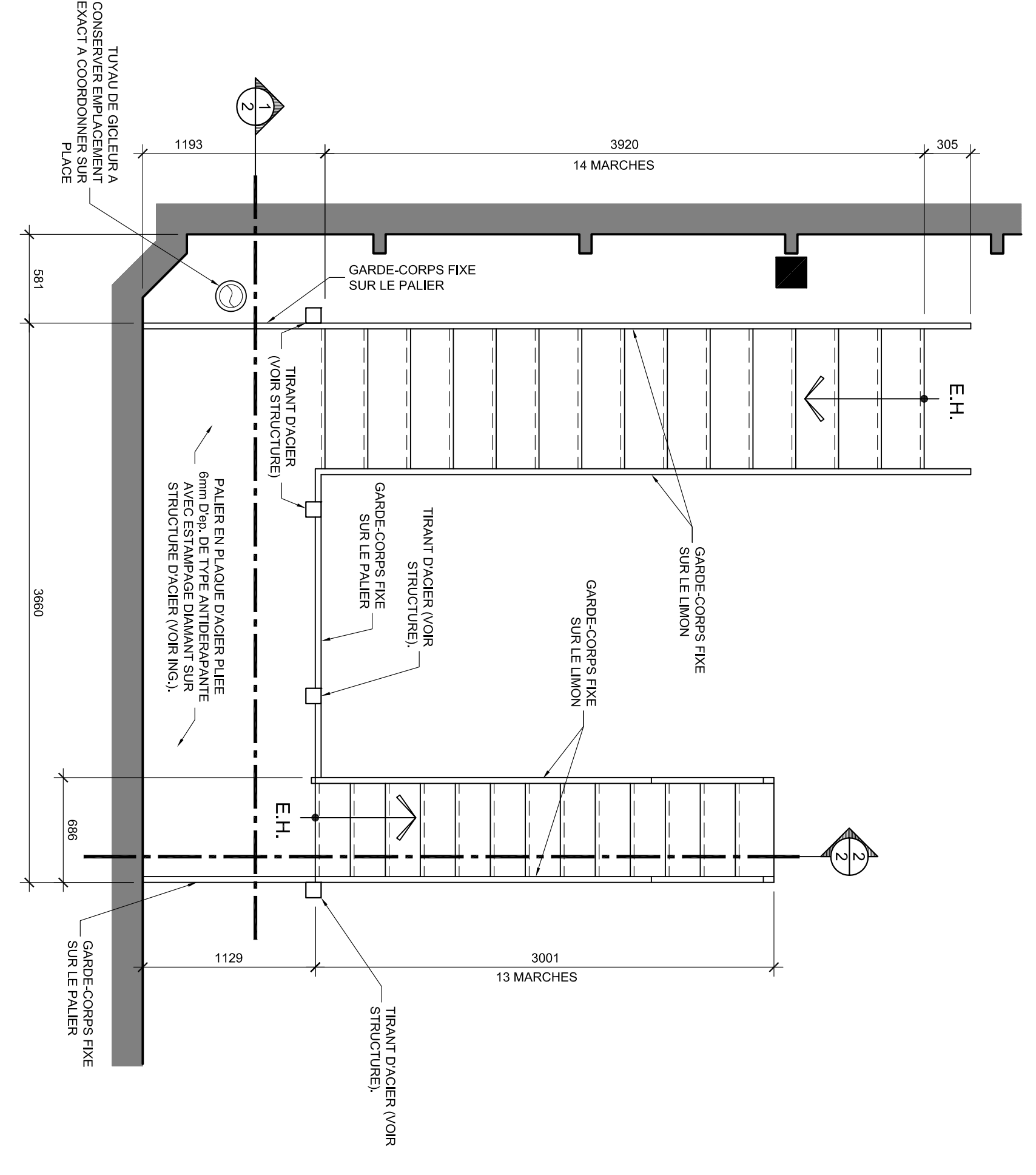

DETAIL TYPE MAIN-COURANTE

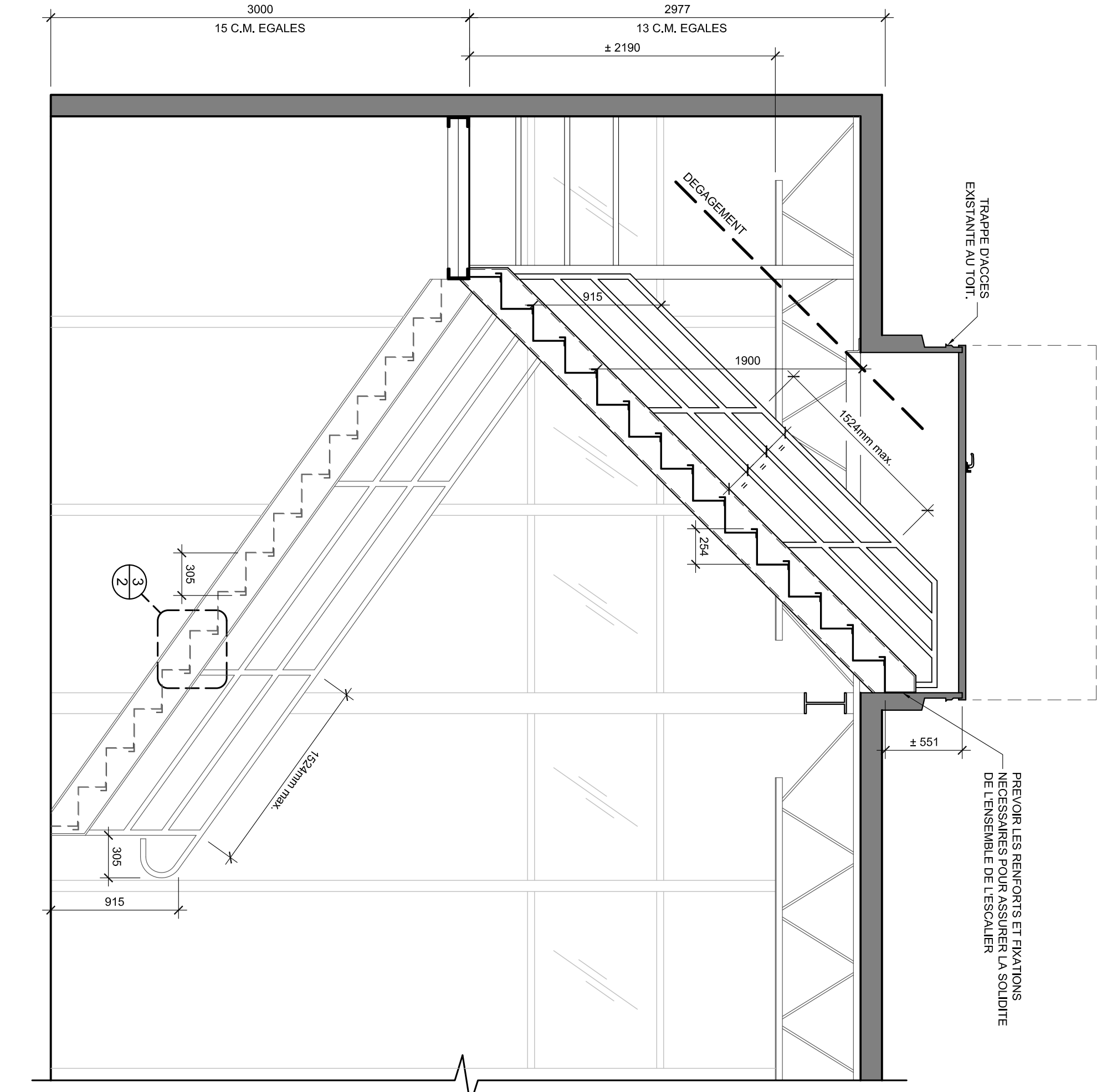
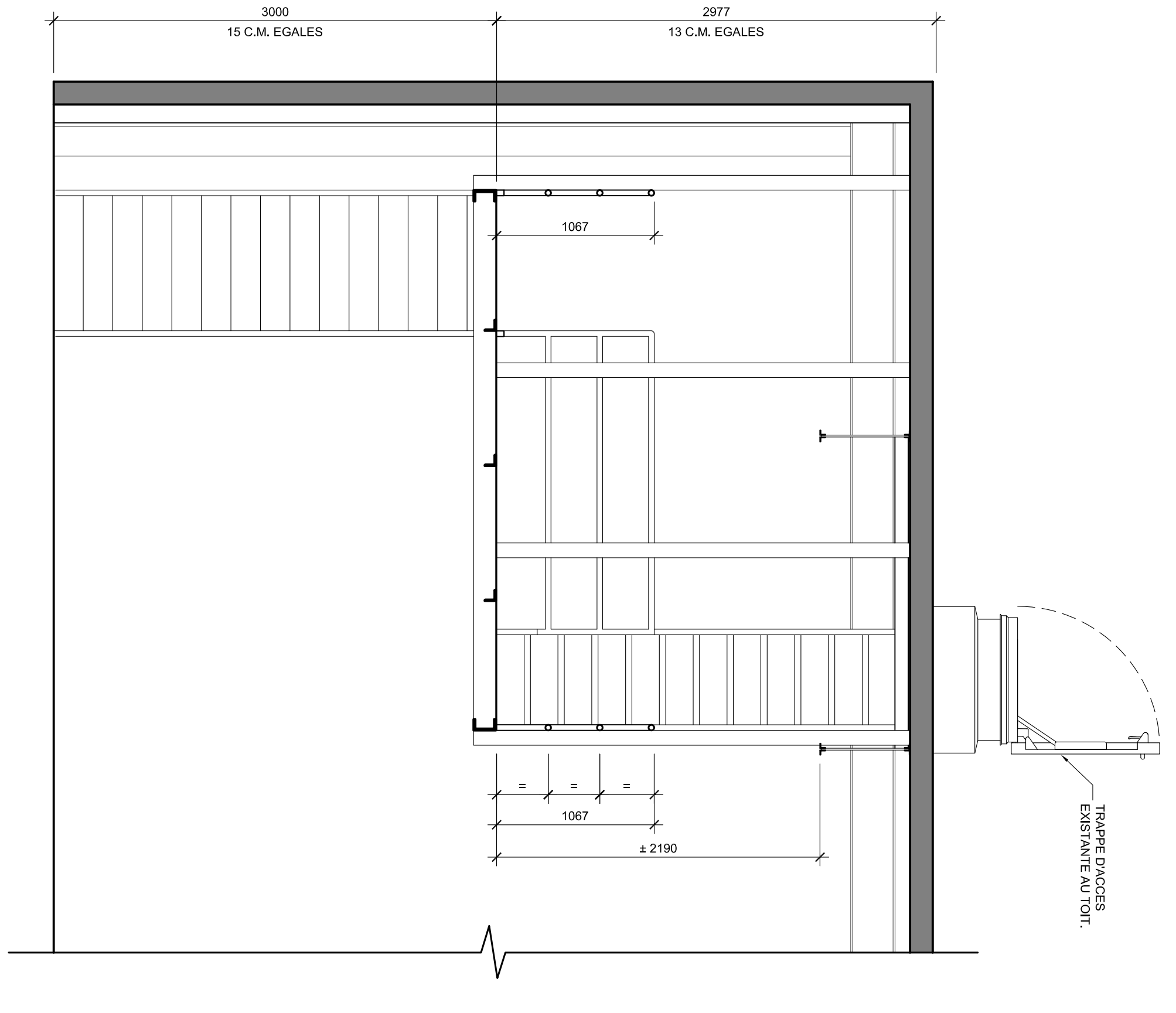
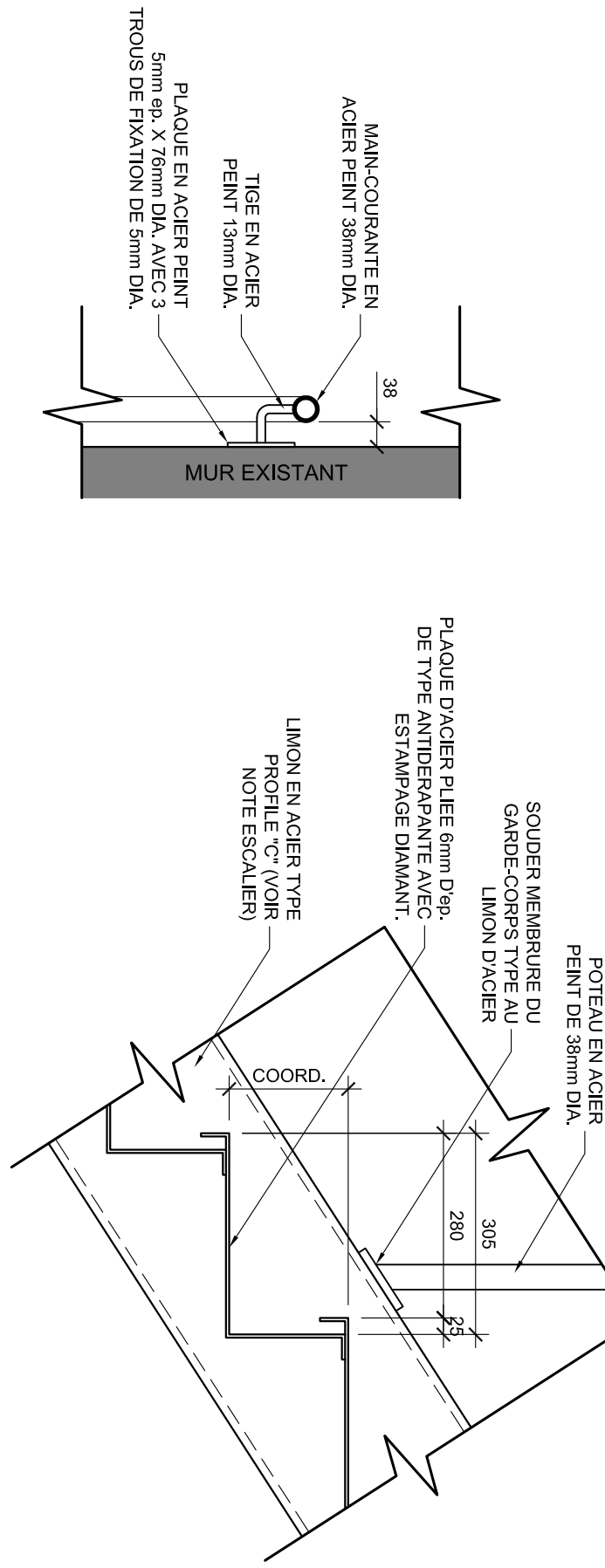

GÉNÉRALITÉS

- AVANT DE COMMENCER LES TRAVAUX VÉRIFIER LES DIMENSIONS SUR PLACE ET TENIR CAS DES DÉVIATIONS EN AVERTISSANT LE REPRÉSENTANT MINISTÉRIEL
- EXAMINER ATTENTIVEMENT LE SITE DES TRAVAUX ET SE FAMILIARISER PRÉLÈMEMENT AVEC LEUR ÉTENDUE.
- CONTENU LA POUSSIERE ET LES DÉBRIS DANS LE PRIMÉRIÈRE DES TRAVAUX ET JUNE FOIS TERMINÉS, NETTOYER LES SURFACES SOULIÈVES.
- RAGRÈER TOUTES LES SURFACES ABIMÉES PAR LE FAIT DES TRAVAUX.
- COORDONNER TOUTES LES INTERRUPTIONS DE SERVICES AVEC LE REPRÉSENTANT MINISTÉRIEL.
- FOURNIR ET INSTALLER TOUS LES MATÉRIAUX ET LA MAIN D'OEUVRE REQUIS POUR PARFAIRE LES OUVRAGES DÉCRITS DANS LES DOCUMENTS CONTRACTUELS.

FAUCHER GAUTHIER
 architectes

133, rue Saint-Georges
 Québec (Québec) J2C 0P3
 Tél. 819.472.0399
 Fax. 819.472.6817
 www.fauchergauthier.com

PLAN CLÉ

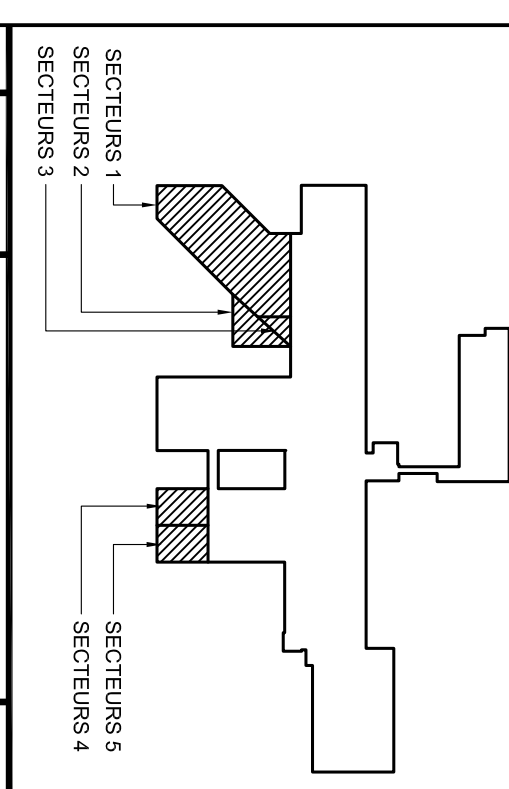

No.	Date	Révision	Date imprimée
1	2014-12-11	Dans notre commentaire	

o Verify all dimensions and site conditions and be responsible for same	o Vérifier toutes les dimensions et l'état des lieux et en assumer la responsabilité
---	--

A Detail no. détail	A
B Location drawing no. sur dessin no.	B
C Drawing no. dessin no.	C

Project: **REFECTION DES TOITURES SECTEUR L1 - L2 ET GARAGE PROJET 14125**

Project: **REFECTION DES TOITURES SECTEUR 1, 2 ET 3**

designed	conçu	date	date
M.F.		DECEMBRE 2014	
drawn	dessiné	scale	échelle
F.B.		INDOUEE	
checked	vérifié	sheet	feuille
M.F.		A2	5
approved	approuvé	W.O. no.	D.T. no.
M.F.			
drawn	dessin no.		
	14125		

NOTES REFECTION SECTEUR 1, 2 ET 3

- L'ENTREPRENEUR EST RESPONSABLE DE RACORDER TOUS LES COMPOSANTS FINANT PARTIES DE L'AMÉNAGEMENT DU TERRAIN POUVANT ÊTRE ENDOUMAGÉS PAR LES TRAVAUX: GAZON, TROTTOIRS, BÉTON ASPHRIE, AMÉNAGEMENTS PAYSAGÉS ET/OU LE GAZON DE DÉCORATION, EN VEILLANT À NE PAS ENDOMAGER LES VÉGÉTAUX EXISTANTS.
- L'ENTREPRENEUR EST RESPONSABLE DE DISPOSER PRES REBUTS DE DÉMOLITION ET DE CONSTRUCTION CONFORMÉMENT À LA RÉGLEMENTATION PROUVINCALE. LES REBUTS DEVONT ÊTRE DISPOSÉS EN UN LIEU D'ÉLIMINATION APPROPRIÉMENT IDENTIFIÉ PAR LA MUNICIPALITÉ.
- L'ENTREPRENEUR DEVRA VÉRIFIER ET VALIDER TOUTES LES MESURES SUR PLACE AVANT LE DÉBUT DES TRAVAUX.
- L'ENTREPRENEUR OU SON SOUS-TRAVANT COUVREUR DEVRONT ÊTRE EN CONTACT AVEC LE REPRÉSENTANT MINISTÉRIEL EN CAS DE QUATRE POUR ÊTRE VALIDÉ AUX GÉOMÈTRES DU MANUFACTURIER.
- NETTOYER L'ENSEMBLE DE LA SURFACE DES PANNEAUX DE SUPPORT EXISTANT CONSERVÉ EN AVANT LE DÉBUT DES TRAVAUX DE REFECTION OU SORTIES AU TOIT (VOIR PLAN).
- UNE GARANTIE DE 12 ANS SUR LES MATÉRIAUX ET DE 5 ANS SUR LA MAIN D'OEUVRE EST EXIGÉE POUR LE PRÉSENT PROJET.
- L'ENTREPRENEUR DEVRA PRENDRE LES DISPOSITIONS NÉCESSAIRES POUR PROTÉGER LE BÂTIMENT, S'ASSURER QU'AUCUN DÉBRIS DE DÉMOLITION ET DE CONSTRUCTION NE RESTE AU SOL.
- L'ENTREPRENEUR DEVRA VÉRIFIER SUR PLACE ET S'ASSURER QU'IL NE RESTE AUCUNE ACCUMULATION D'EAU SUR LA NOUVELLE MEMBRANE, DE PRÉFÉRENCE PAR UN SÉRIEUX TEST D'EAU SUR LA NOUVELLE MEMBRANE APRÈS LA FIN DE CORRIGER LES DÉPRESSIONS DANS LE POINTAGE EXISTANT ET D'ASSURER UN ÉCOULEMENT ADOQUAT DES EAUX DE PLUIE.
- L'ENTREPRENEUR DEVRA, À LA FIN DES TRAVAUX, PASSER UN AMMANT SUR LA NOUVELLE TOITURE ET AU PÉRIMÈTRE DU BÂTIMENT DANS LE SÉCTEUR DES TRAVAUX POUR RAMASSER LES VHS, COUSS, ETC.
- L'ENSEMBLE DES TRAVAUX DÉLICTRICE SONT HORS CONTRAT.
- L'ENTREPRENEUR DEVRA PRENDRE LES PRÉCAUTIONS NÉCESSAIRES POUR PROTÉGER LA NOUVELLE MEMBRANE PENDANT LES TRAVAUX DE REFECTION.
- PREVOIR L'AJOUT D'UN NOUVEAU PANNEAU S'UPPORT DE TYPE "SOPRABORD 6.4" DE SOPRIMA ÉQUIVALENT À 30 m.c. (COORDONNER LES SÉCTEURS SUR PLACE AVEC LE CLIENT).
- L'ENTREPRENEUR DEVRA VÉRIFIER LE DESSOUS DU PONTAGE MÉTALLIQUE EXISTANT AVANT DE RÉPARER MÉCANIQUEMENT LES NOUVEAUX ÉLÉMENTS DE LA TOITURE. LES TRAVAUX DE RÉPARATION SONT À CONDUIRE EN SUITE À LA VÉRIFICATION AVEC LE CLIENT.

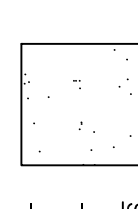

- SECTEUR 1 OU PREVOIR NOUVEAU SYSTÈME DE TOITURE:
 - PREVOIR 1 PLS DE NOUV. PARAPET FEUTRE ASPHALTE 1800
 - PREVOIR COLLE ALUMINUM EN CHAÎNE, EXPANSE AVEC FIBRE DE BOIS LAMINÉ EN USINE COLLE AVEC COLLE "TOUTOUC" DE SOPRIMA
 - NOUVEAU PANNEAU DE FIBRE CÉRAMIQUE DE TYPE MANVILLE
 - L'ASPHALTE CHAUDE 2X 50mm DE TYPE "ENERGY" DE JOHNS MANVILLE
 - SÉCRIPAN 13mm COLLE À L'ASPHALTE CHAUD.
 - NOUVELLE MEMBRANE DE SOUS-COUCHE COLLE À L'ASPHALTE CHAUD (TYPE ELASTOOL 500" DE SOPRIMA, FLAM 250 GR" DE SOPRIMA)
 - PREVOIR DES PANNEAUX ASPHALTIQUE DE TYPE "SOPRABORD 3mm" DE SOPRIMA POUR RÉMONTÉE DE MEMBRANE SI REQUIS.
- DÉGRADULER LA MEMBRANE EXIST. ET PREVOIR APPRET DE TYPE ELASTOOL 500" DE SOPRIMA POUR LES SÉCTEURS OÙ LA NOUVELLE MEMBRANE SERA SOUDÉE SUR LA MEMBRANE EXISTANTE.
- REPARER L'ÉTANCHÉITE COMPLÈTE DES RÉMONTÉES TYPES, (VOIR DÉTAIL).
- REPARER L'ENSEMBLE DE L'ÉTANCHÉITE DES RÉMONTÉES DE MEMBRANE SUR LA BASE TYPE. PREVOIR NOUVEL ISOLANT POLYSTYRÈNE EXPANSE DE TYPE 40E 100mm DÉPASSER LE PÉRIMÈTRE DE LA BASE TYPE. COORDONNER L'ARRET DES VENTILATEURS AVEC LE CLIENT. (VOIR DÉTAIL)
- REPARER L'ENSEMBLE DE L'ÉTANCHÉITE DES RÉMONTÉES DE POLYSTYRÈNE EXPANSE DE TYPE 40E 100mm DÉPASSER, DE LA BASE TYPE ET REINSTALLER LE VENTILATEUR DE TYPE INVASION (VOIR DÉTAIL)
- PREVOIR UN NOUV. SOLIN D'ACIER PRÉFINI CAL. 28. AU PÉRIMÈTRE DE LA BASE TYPE.
- REPARER L'ÉTANCHÉITE COMPLÈTE ET PREVOIR UN NOUV. SOLIN D'ACIER (VOIR DÉTAIL).
- PREVOIR NOUVEAU SOLIN DÉVIENT EN ALUMINIUM PRÉMOULÉ ET SOUDURES (VOIR DÉTAIL).
- PREVOIR LINE NOUV. DÉPRESSION 1200mm X 1200mm AU PÉRIMÈTRE DU L'INT. AVANT AUCUNE SURÉLÈVÉE À LA JOINTURE DE LA PENTE DE TOIT ET DE LA DÉPRESSION.
- NOUVEAU DRAIN DE CUIVRE: TEL. QUE "NO-28C" DE THALER EN ALUMINIUM (VOIR DÉTAIL).
- DESSUS DU PARAPET EXISTANT EN PANNEAUX D'ALUMINIUM ALPOLOC CONSERVÉ.
- NOUVELLE TRAPPE D'ACCÈS AU TOIT DE 760mm X 2440mm MODÈLE "T" (ACCÈS PAR ESCALIERS DE SERVICE) DE LA COMPAGNIE BILCO. LES RECOMMANDATIONS DU 1418.

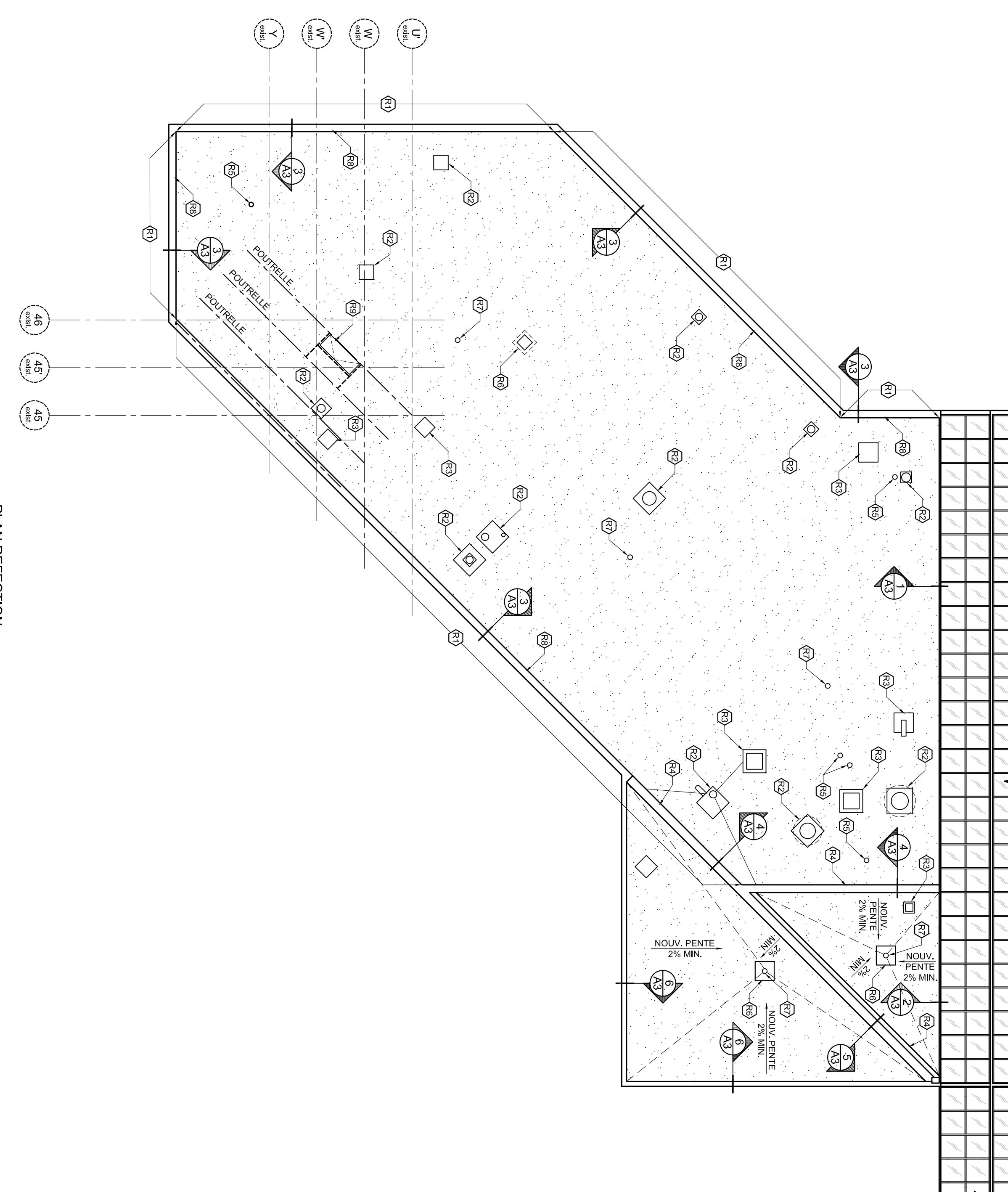

PLAN REFECTION TOITURE SECTEUR 1, 2 ET 3
 ÉCHELLE: 1:300

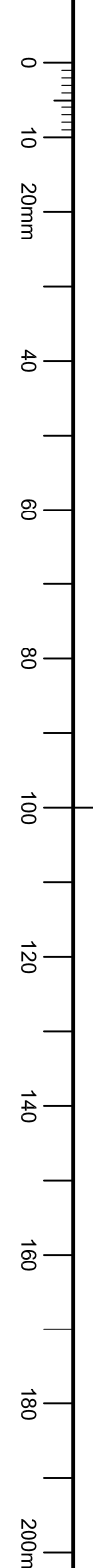

C

GÉNÉRALITÉS

- AVANT DE COMMENCER LES TRAVAUX VÉRIFIER LES MESURES SUR LE PLAN ET EN CAS DE DIVERGENCE COMMUNIQUER EN AVERTISSANT LE REPRÉSENTANT MINISTÉRIEL
- EXAMINER ATTENTIVEMENT LE SITE DES TRAVAUX ET SE FAMILIARISER PLÉNIÈREMENT AVEC LEUR ÉTENDUE.
- CONTENUER LA POUSSIERE ET LES DÉBRIS DANS LE PÉRIMÈTRE DES TRAVAUX ET JUNE FOIS TERMINÉS, NETTOYER LES SURFACES SOULLEVÉS.
- RAGRÈSER TOUTES LES SURFACES ABIMÉES PAR LE FAIT DES TRAVAUX.
- COORDONNER TOUTES LES INTERRUPTIONS DE SERVICES AVEC LE REPRÉSENTANT MINISTÉRIEL.
- FOURIR ET INSTALLER TOUS LES MATÉRIAUX ET LA MAIN D'ŒUVRE REQUIS POUR PARFAIRE LES OUVRAGES DÉCRITS DANS LES DOCUMENTS CONTRACTUELS.

PLAN CLÉ

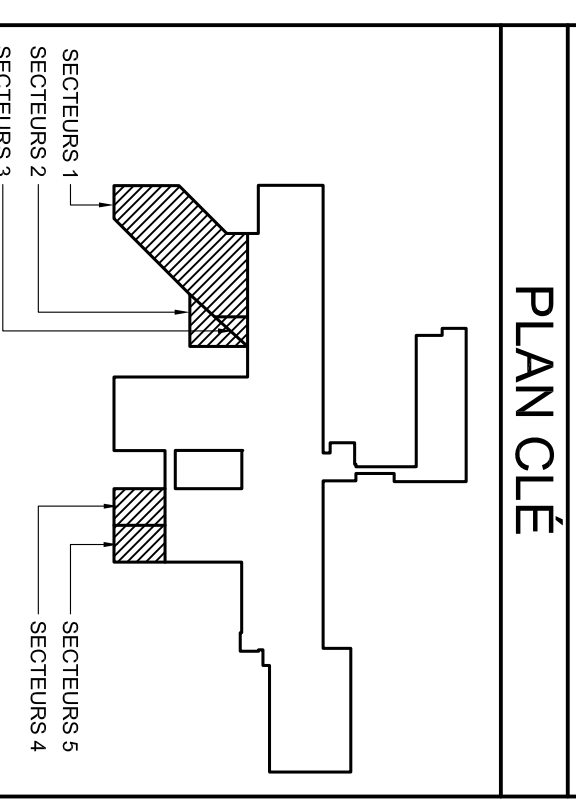

FAUCHER GAUTHIER
 arch it ectes

133, rue Saint-Georges
 Saint-Jean-sur-Richelieu, QC J2C 0P3
 Tél. 819-422-0399
 Tél. 819-422-6817
 Fax 819-422-6817
 www.fauchergauthier.com

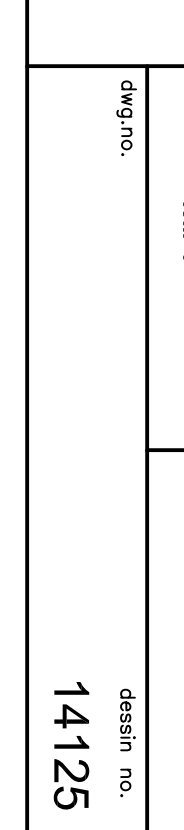
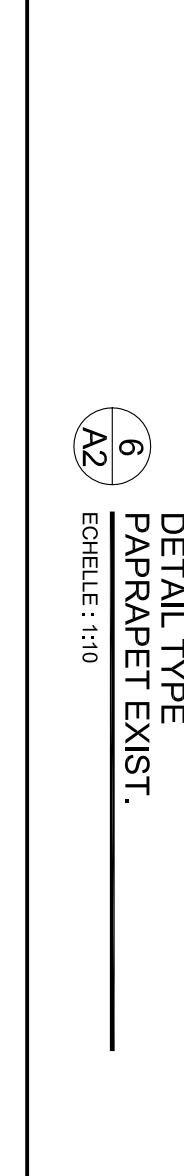
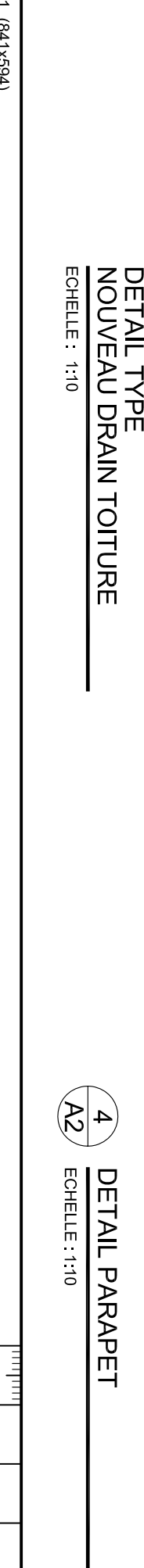
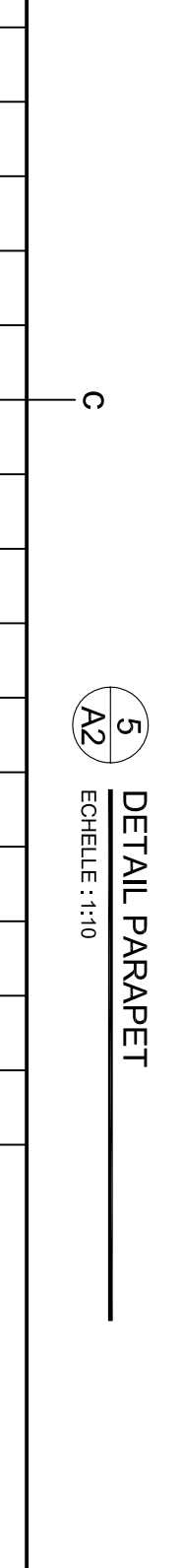
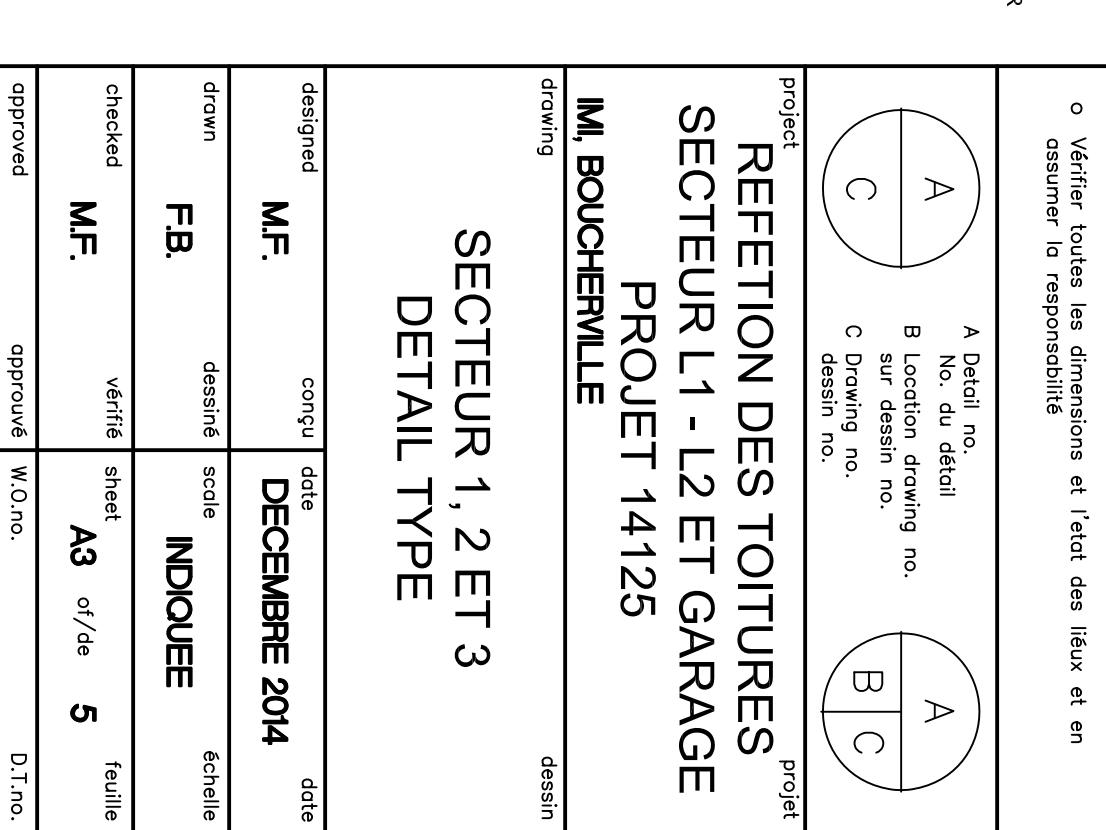
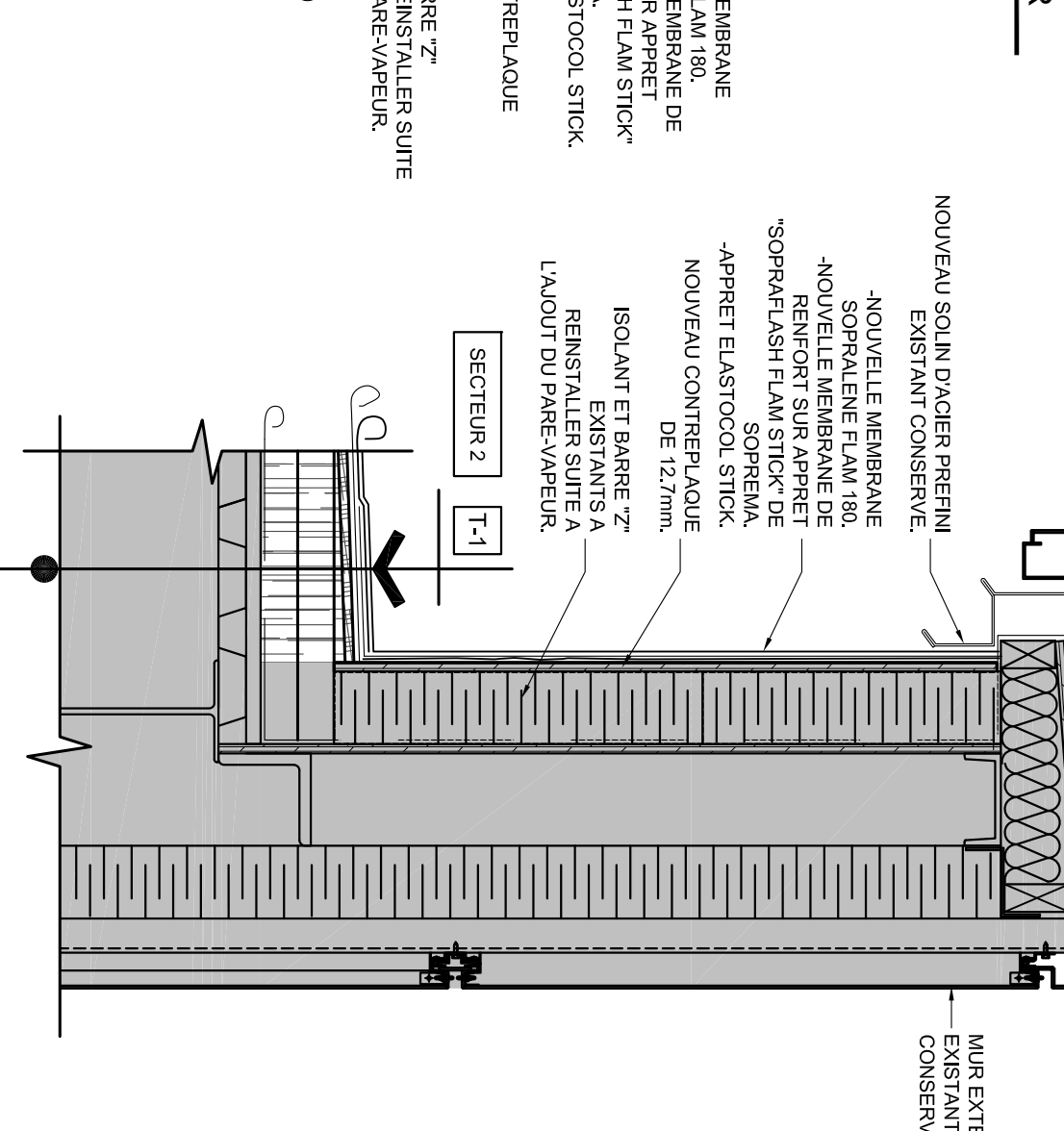
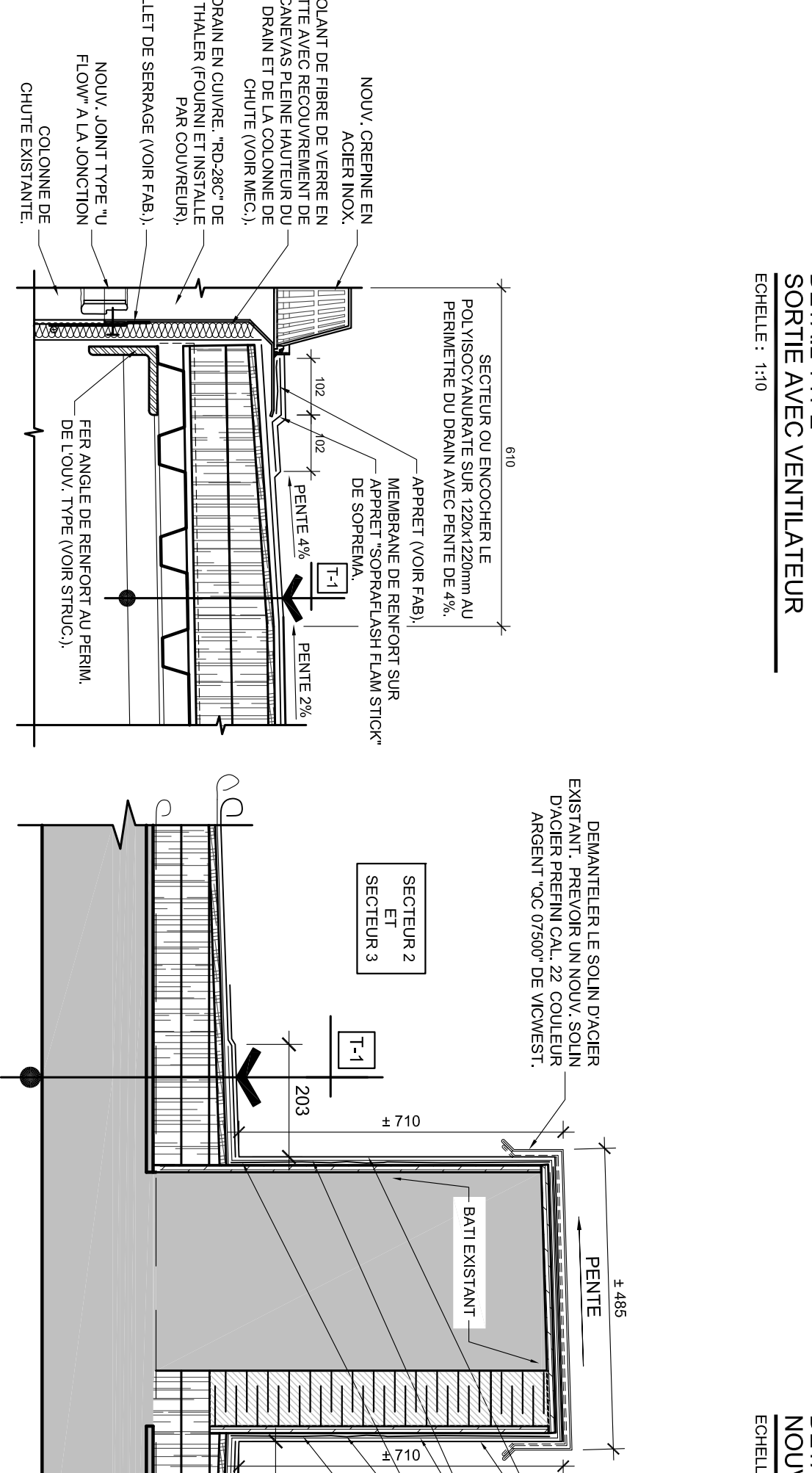
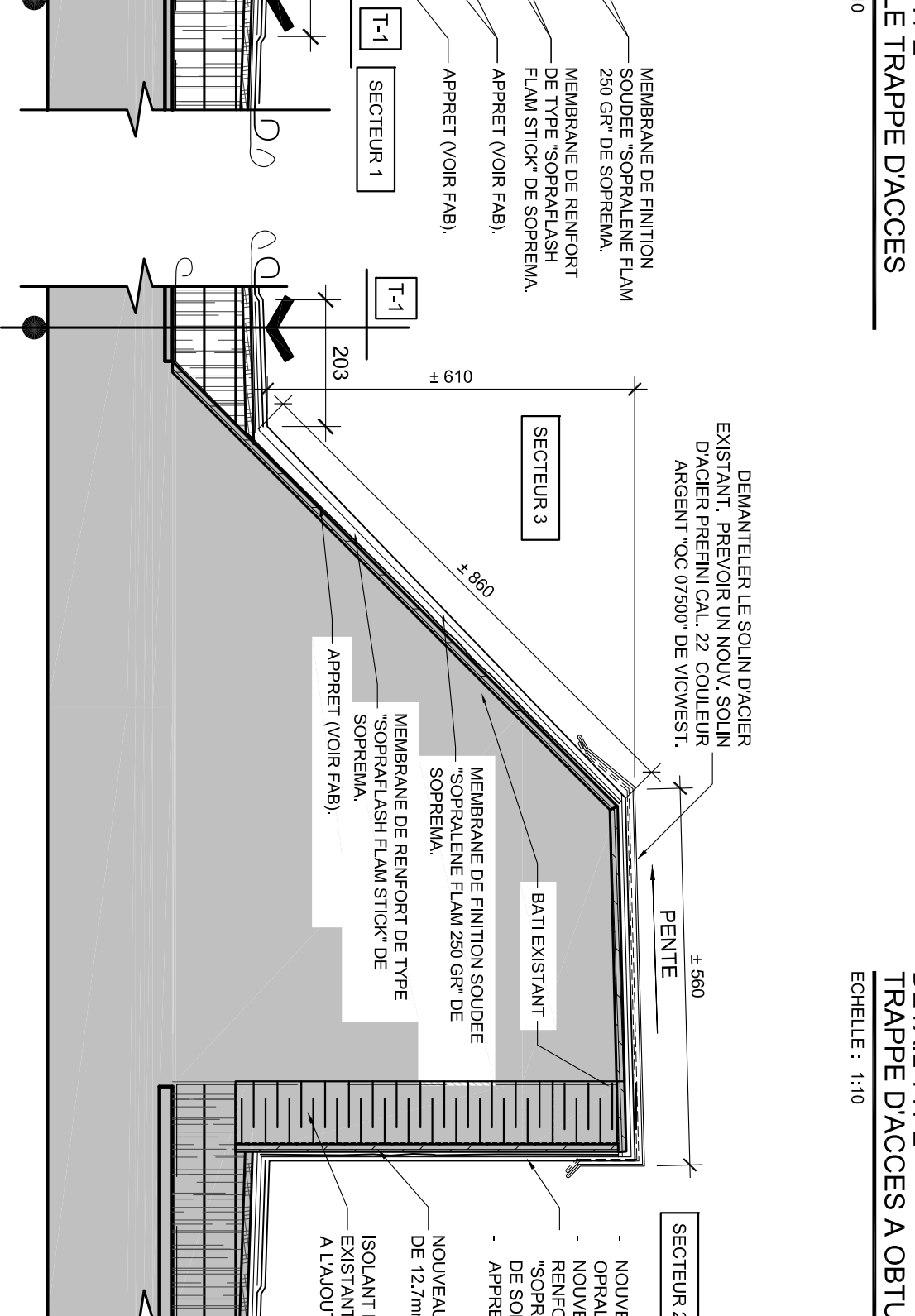
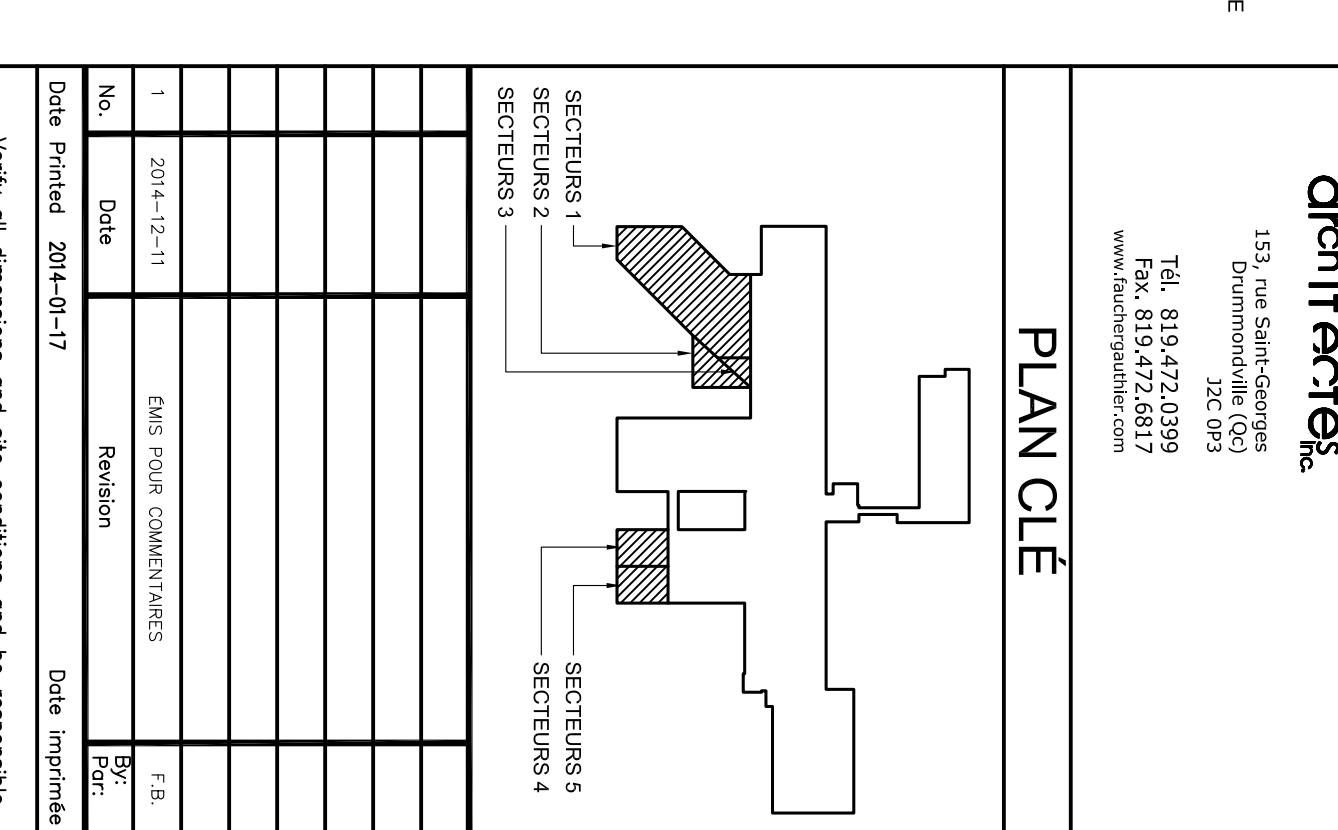
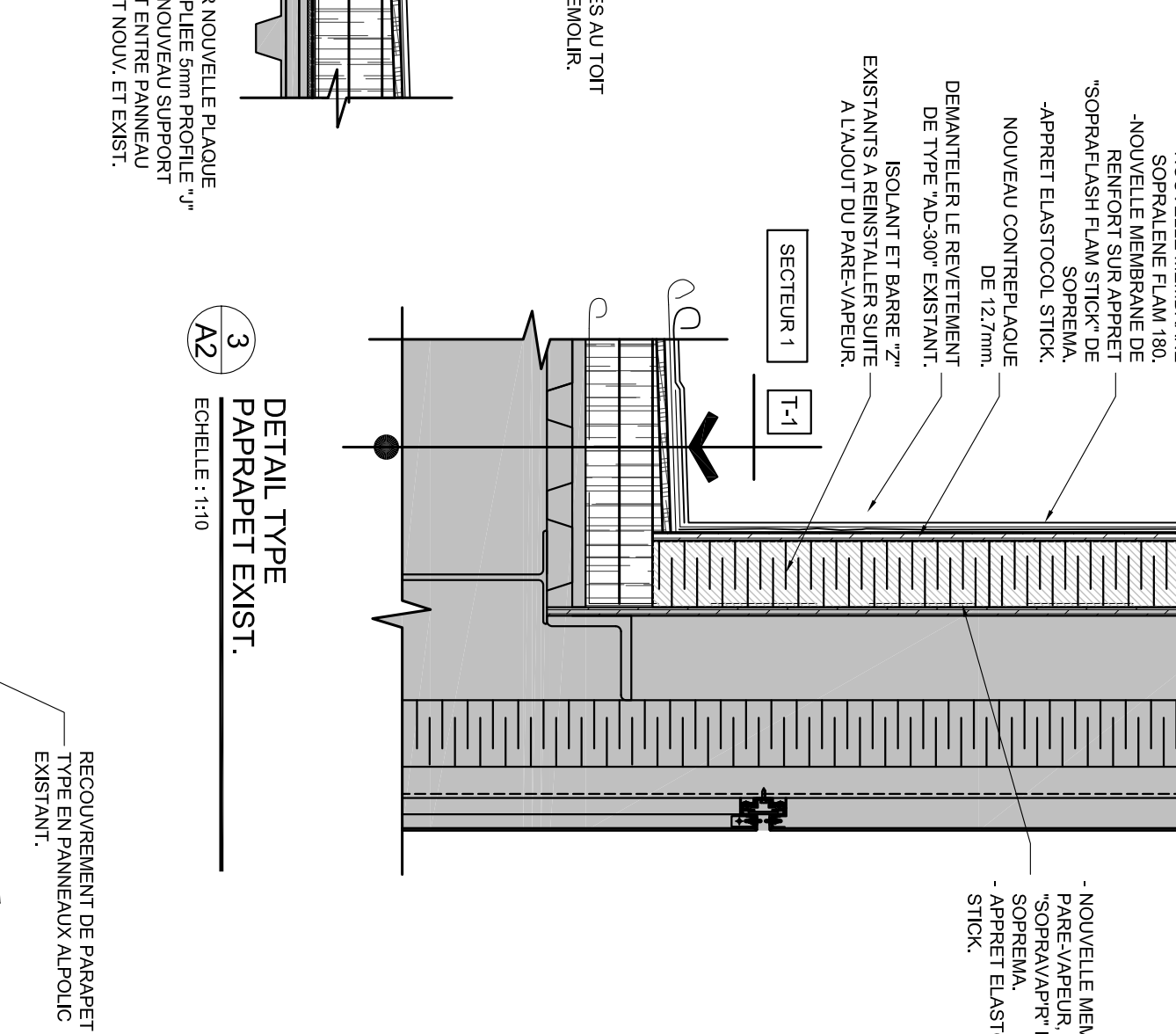
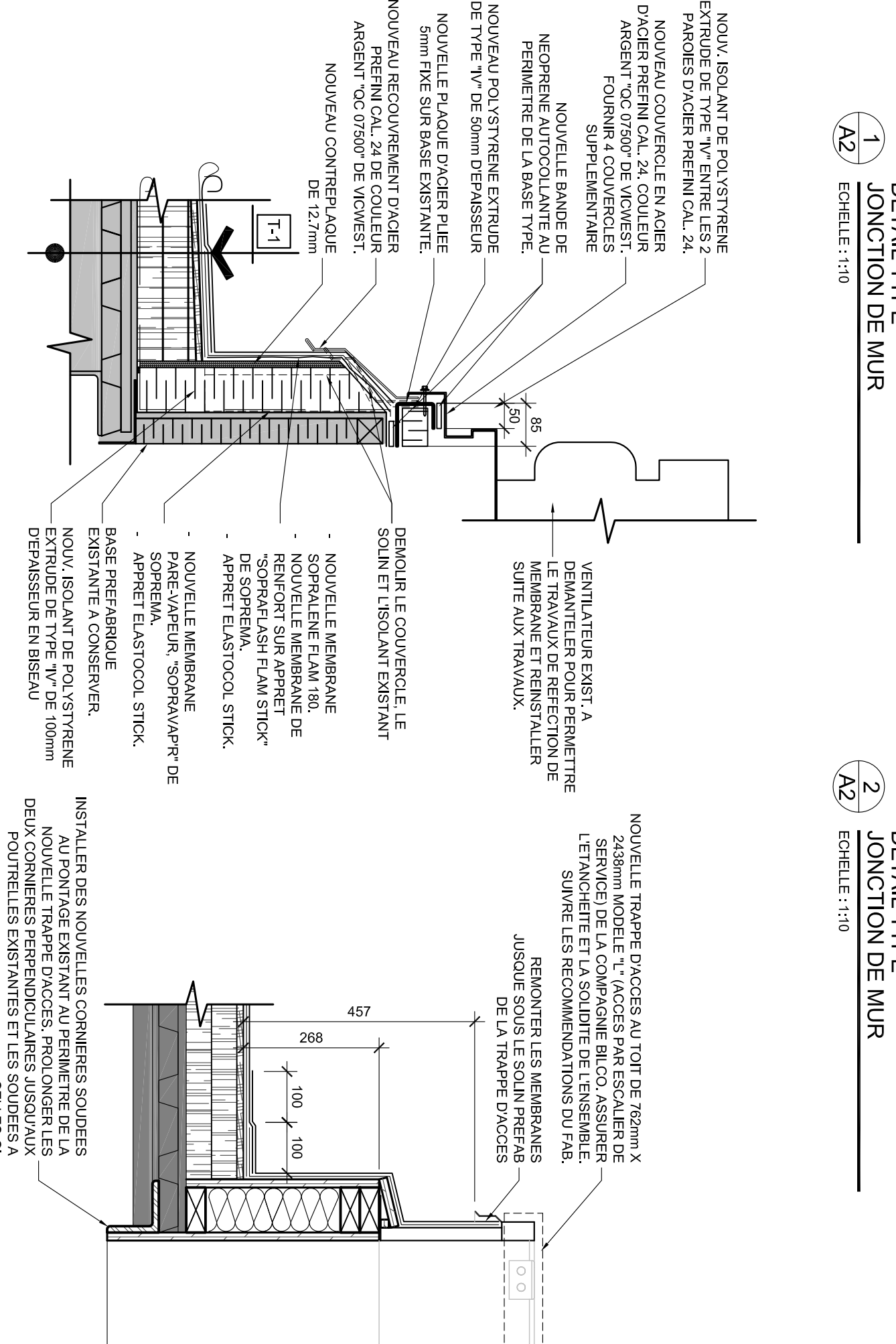
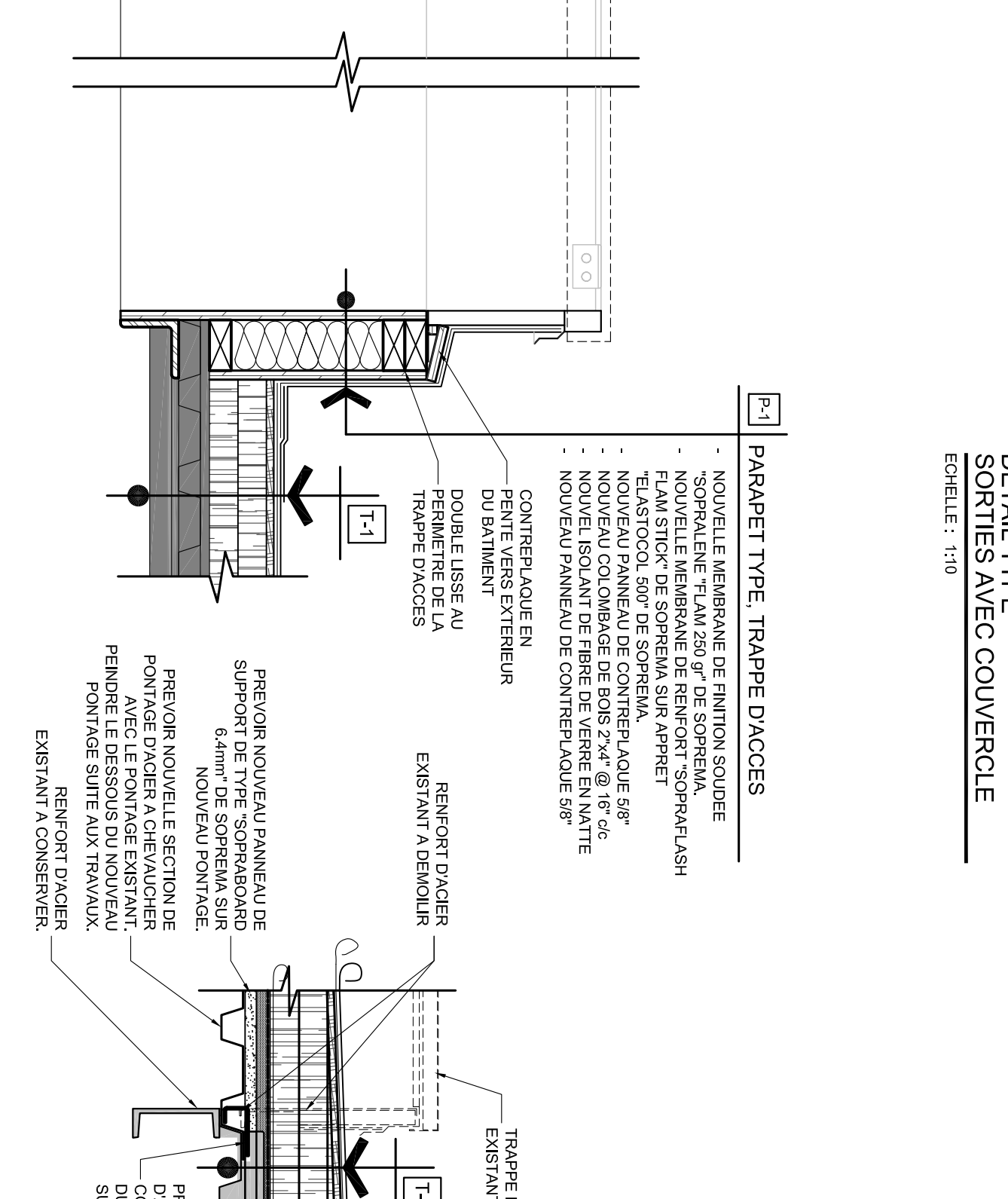
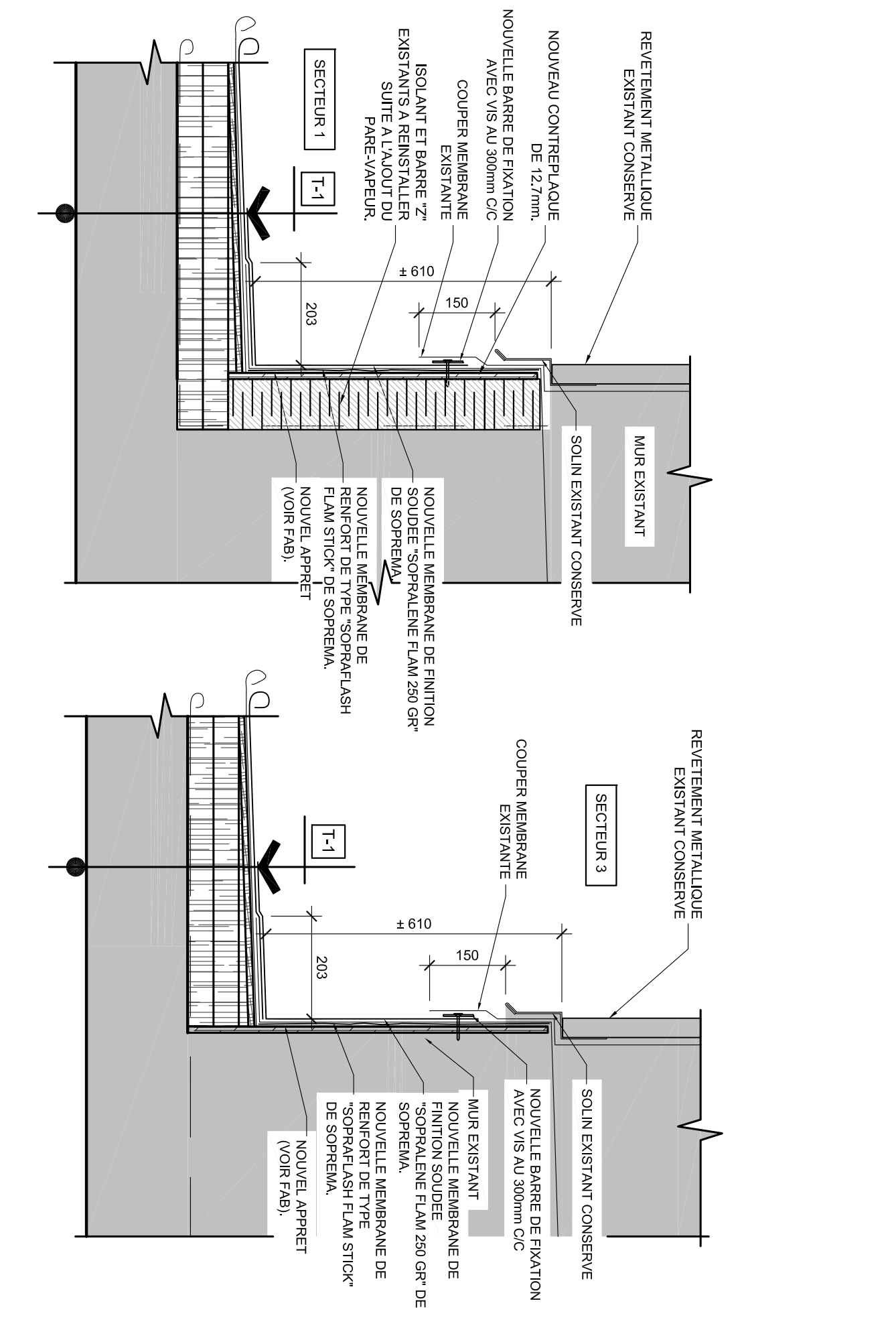
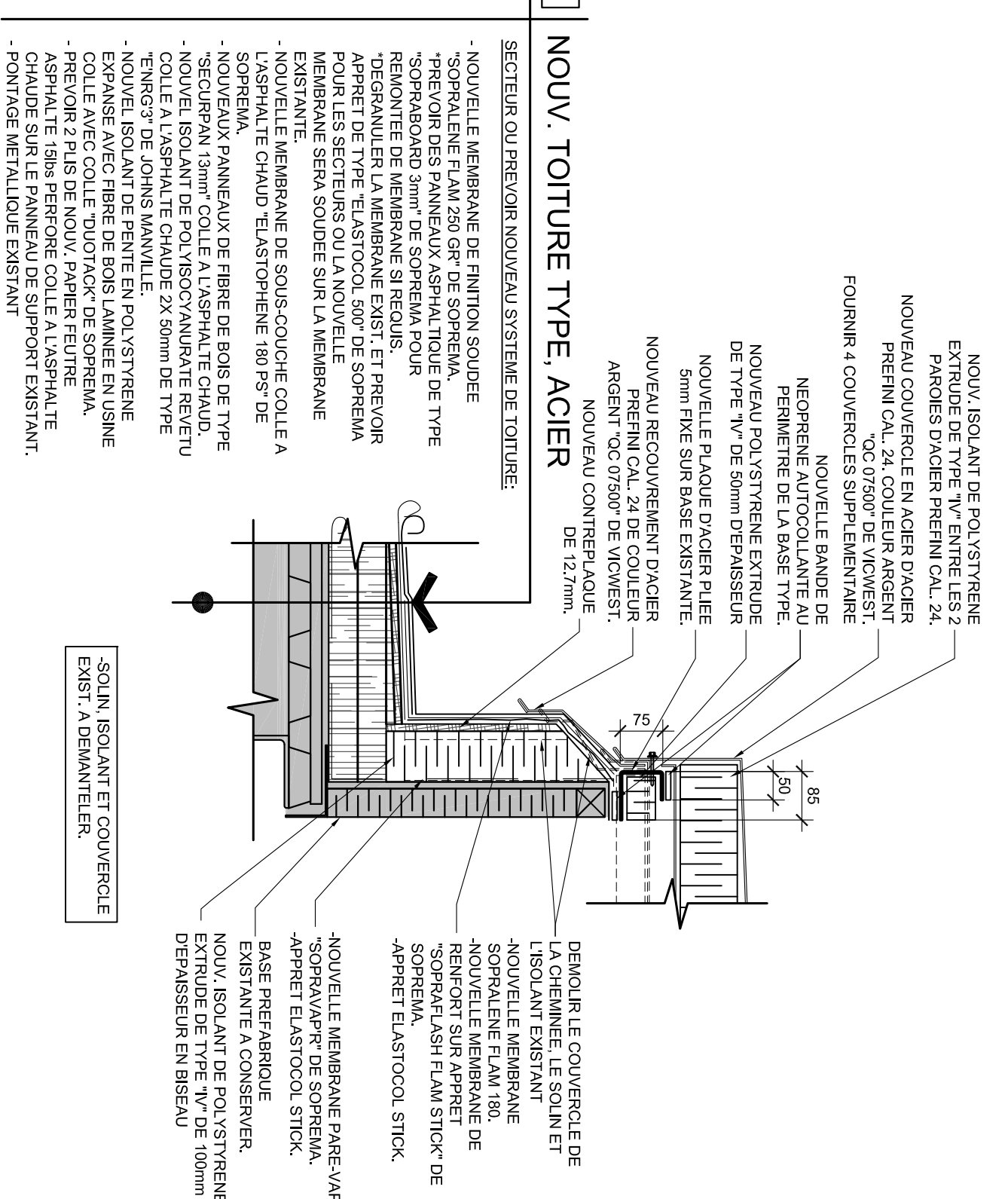
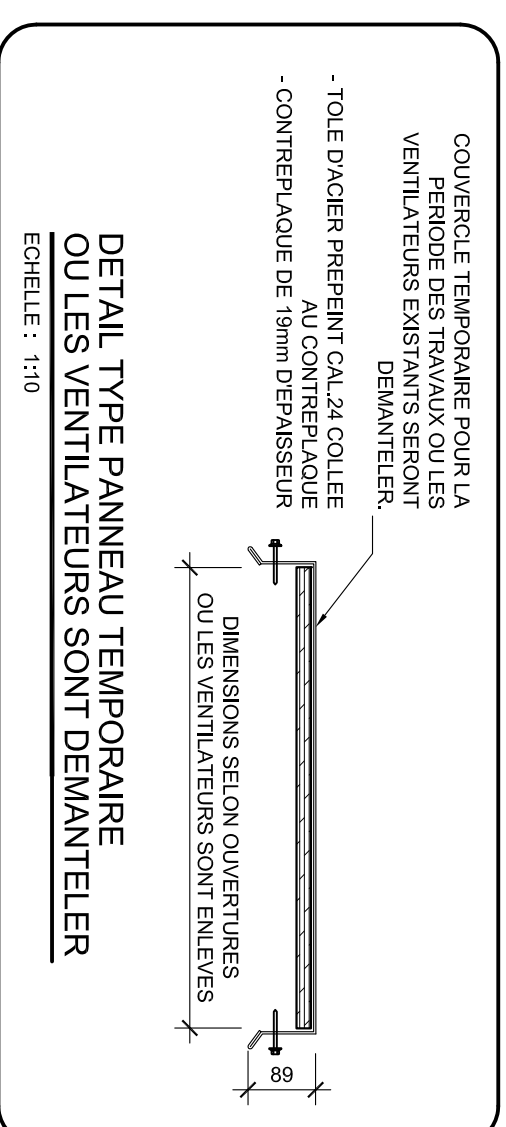
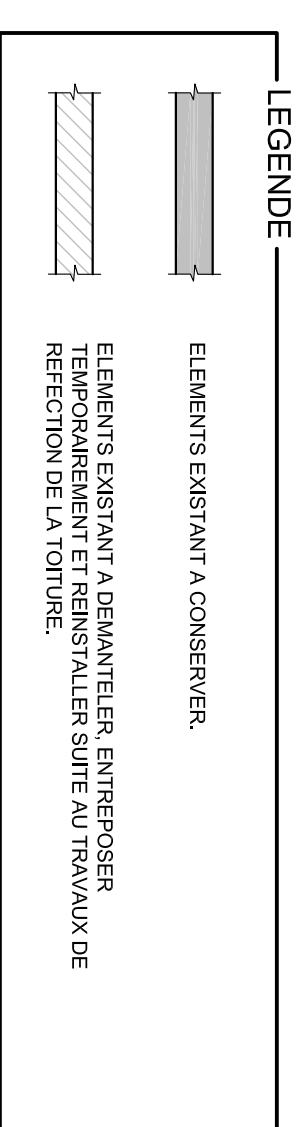

designé	conçu	date	date
M.F.	DECEMBRE 2014		
F.B.	INDOUEE		
M.F.	5		
M.F.	14125		

No.	Date	Revision	Date imprimée
1	2014-12-11		

designé	conçu	date	date
M.F.	DECEMBRE 2014		
F.B.	INDOUEE		
M.F.	5		
M.F.	14125		

designé	conçu	date	date
M.F.	DECEMBRE 2014		
F.B.	INDOUEE		
M.F.	5		
M.F.	14125		

designé	conçu	date	date
M.F.	DECEMBRE 2014		
F.B.	INDOUEE		
M.F.	5		
M.F.	14125		

designé	conçu	date	date
M.F.	DECEMBRE 2014		
F.B.	INDOUEE		
M.F.	5		
M.F.	14125		

designé	conçu	date	date
M.F.	DECEMBRE 2014		
F.B.	INDOUEE		
M.F.	5		
M.F.	14125		

designé	conçu	date	date
M.F.	DECEMBRE 2014		
F.B.	INDOUEE		
M.F.	5		
M.F.	14125		

designé	conçu	date	date
M.F.	DECEMBRE 2014		
F.B.	INDOUEE		
M.F.	5		
M.F.	14125		

designé	conçu	date	date
M.F.	DECEMBRE 2014		
F.B.	INDOUEE		
M.F.	5		
M.F.	14125		

designé	conçu	date	date
M.F.	DECEMBRE 2014		
F.B.	INDOUEE		
M.F.	5		
M.F.	14125		

designé	conçu	date	date
M.F.	DECEMBRE 2014		
F.B.	INDOUEE		
M.F.	5		
M.F.	14125		

designé	conçu	date	date
M.F.	DECEMBRE 2014		
F.B.	INDOUEE		
M.F.	5		
M.F.	14125		

designé	conçu	date	date
M.F.	DECEMBRE 2014		
F.B.	INDOUEE		
M.F.	5		
M.F.	14125		

designé	conçu	date	date
M.F.	DECEMBRE 2014		
F.B.	INDOUEE		
M.F.	5		
M.F.	14125		

designé	conçu	date	date
M.F.	DECEMBRE 2014		
F.B.	INDOUEE		
M.F.	5		
M.F.	14125		

designé	conçu	date	date
M.F.	DECEMBRE 2014		
F.B.	INDOUEE		
M.F.	5		
M.F.	14125		

designé	conçu	date	date
M.F.	DECEMBRE 2014		
F.B.	INDOUEE		
M.F.	5		
M.F.	14125		

designé	conçu	date	date
M.F.	DECEMBRE 2014		
F.B.	INDOUEE		
M.F.	5		
M.F.	14125		

designé	conçu	date	date
M.F.	DECEMBRE 2014		
F.B.	INDOUEE		
M.F.	5		
M.F.	14125		

designé	conçu	date	date
M.F.	DECEMBRE 2014		
F.B.	INDOUEE		
M.F.	5		
M.F.	14125		

designé	conçu	date	date
M.F.	DECEMBRE 2014		
F.B.	INDOUEE		
M.F.	5		
M.F.	14125		

designé	conçu	date	date
M.F.	DECEMBRE 2014		
F.B.	INDOUEE		
M.F.	5		
M.F.	14125		

designé	conçu	date	date
M.F.	DECEMBRE 2014		
F.B.	INDOUEE		
M.F.	5		
M.F.	14125		

designé	conçu	date	date
M.F.	DECEMBRE 2014		
F.B.	INDOUEE		
M.F.	5		
M.F.	14125		

designé	conçu	date	date
M.F.	DECEMBRE 2014		
F.B.	INDOUEE		
M.F.	5		
M.F.	14125		

designé	conçu	date	date
M.F.	DECEMBRE 2014		
F.B.	INDOUEE		
M.F.	5		
M.F.	14125		

designé	conçu	date	date
M.F.	DECEMBRE 2014		
F.B.	INDOUEE		
M.F.	5		
M.F.	14125		

designé	conçu	date	date
M.F.	DECEMBRE 2014		
F.B.	INDOUEE		
M.F.	5		
M.F.	14125		

designé	conçu	date	date
M.F.	DECEMBRE 2014		
F.B.	INDOUEE		
M.F.	5		
M.F.	14125		

designé	conçu	date	date
M.F.	DECEMBRE 2014		
F.B.	INDOUEE		
M.F.	5		
M.F.	14125		

designé	conçu	date	date
M.F.	DECEMBRE 2014		
F.B.	INDOUEE		
M.F.	5		
M.F.	14125		

designé	conçu	date	date
M.F.	DECEMBRE 2014		
F.B.	INDOUEE		
M.F.	5		
M.F.	14125		

designé	conçu	date	date
M.F.	DECEMBRE 2014		
F.B.	INDOUEE		
M.F.	5		
M.F.	14125		

designé	conçu	date	date
M.F.	DECEMBRE 2014		
F.B.	INDOUEE		
M.F.	5		
M.F.	14125		

designé	conçu	date	date
M.F.	DECEMBRE 2014		
F.B.	INDOUEE		
M.F.	5		
M.F.	14125		

designé	conçu	date	date
M.F.	DECEMBRE 2014		
F.B.	INDOUEE		
M.F.	5		
M.F.	14125		

designé	conçu	date	date
M.F.	DECEMBRE 2014		
F.B.	INDOUEE		
M.F.	5		
M.F.	14125		

designé	conçu	date	date
M.F.	DECEMBRE 2014		
F.B.	INDOUEE		
M.F.	5		
M.F.	14125		

designé	conçu	date	date
M.F.	DECEMBRE 2014		
F.B.	INDOUEE		
M.F.	5		
M.F.	14125		

designé	conçu	date	date
M.F.	DECEMBRE 2014		
F.B.	INDOUEE		
M.F.	5		
M.F.	14125		

designé	conçu	date	date
M.F.	DECEMBRE 2014		
F.B.	INDOUEE		
M.F.	5		
M.F.	14125		

designé	conçu	date	date
M.F.	DECEMBRE 2014		
F.B.	INDOUEE		
M.F.	5		
M.F.	14125		

designé	conçu	date	date
M.F.	DECEMBRE 2014		
F.B.	INDOUEE		
M.F.	5		
M.F.	14125		

RC - CNRC

GÉNÉRALITÉS

- AVANT DE COMMENCER LES TRAVAUX VÉRIFIER LES MESURES, LE PLAN ET EN CAS DE DIVERGENCE, ENVOYER UN LE REPRESENTANT MINISTERIEL
- EXAMINER ATTENTIVEMENT LE SITE DES TRAVAUX ET SE FAMILIARISER PLACEMENT AVEC LEUR ETENDUE.
- CONTENU LA POUSSIERE ET LES DEBRIS DANS LE PERIMETRE DES TRAVAUX ET UNE FOIS TERMINES, NETTOYER LES SURFACES SOULIEES.
- RAGREER TOUTES LES SURFACES ABIMEES PAR LE FAIT DES TRAVAUX.
- COORDONNER TOUTES LES INTERRUPTIONS DE SERVICES AVEC LE REPRESENTANT MINISTERIEL.
- POINER ET INSTALLER TOUS LES MATERIAUX ET LA MAIN D'OEUVRE REQUIS POUR PARER A LES OUVRAGES DECRTS DANS LES DOCUMENTS CONTRACTUELS.

PLAN CLÉ

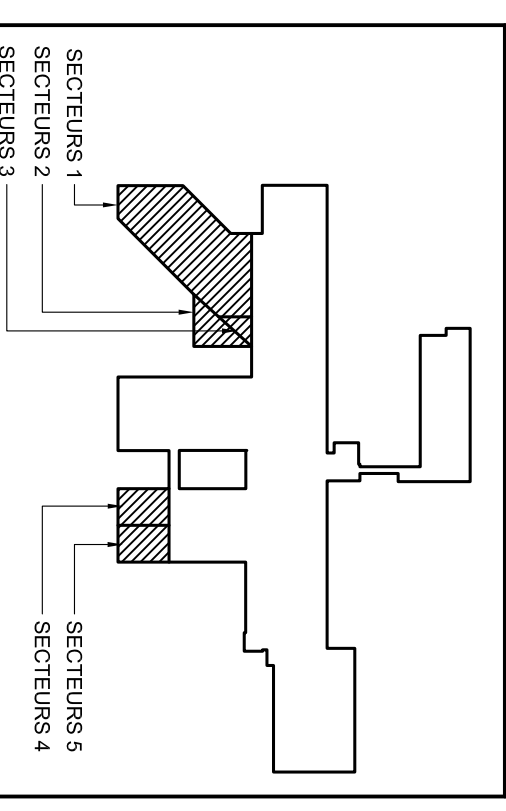

FAUCHER GAUTHIER
 archi it ectes inc.

133, rue Saint-Georges
 Saint-Jean-sur-Richelieu, QC J2C 0P3
 Tél. 819-472-0399
 Tél. 819-472-6817
 Fax. 819-472-6817
 www.fauchergauthier.com

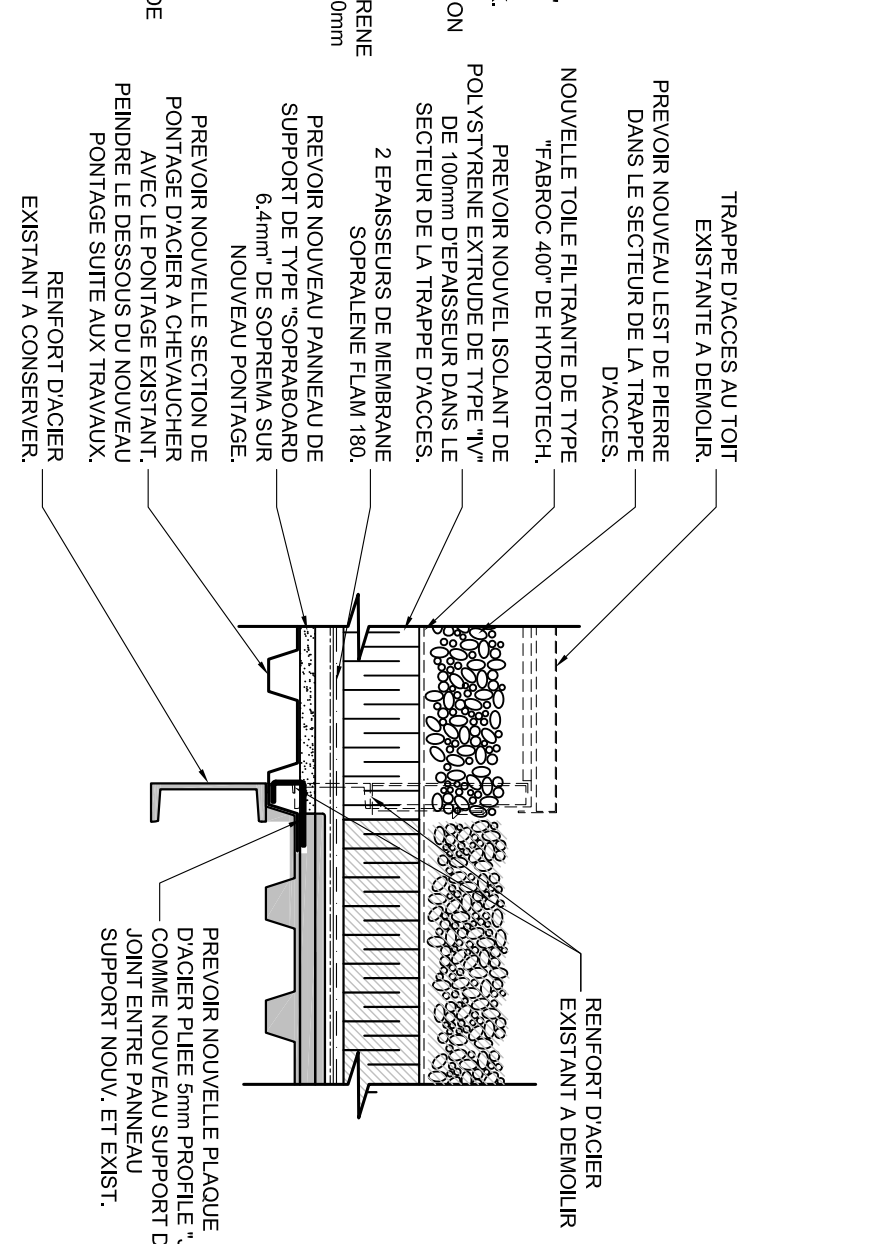
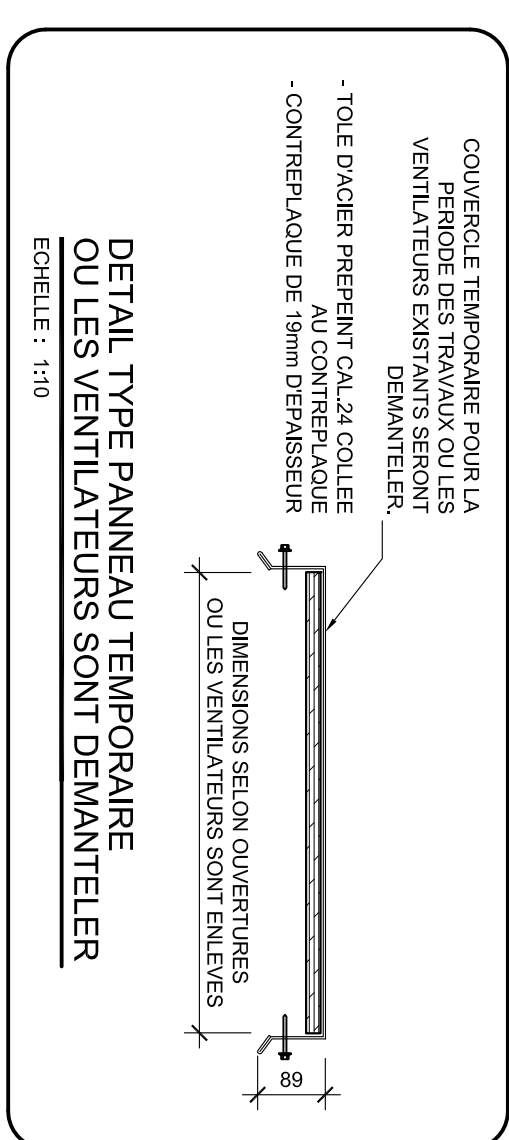
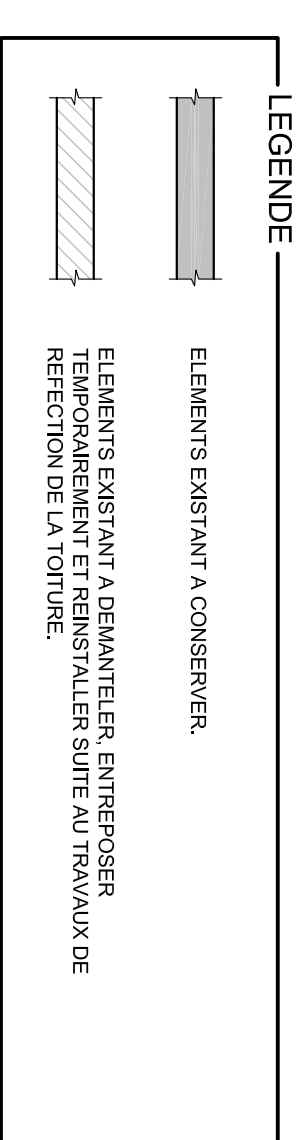

DETAIL TYPE
SORTIE AVEC VENTILATEUR
 ECHELLE : 1:10

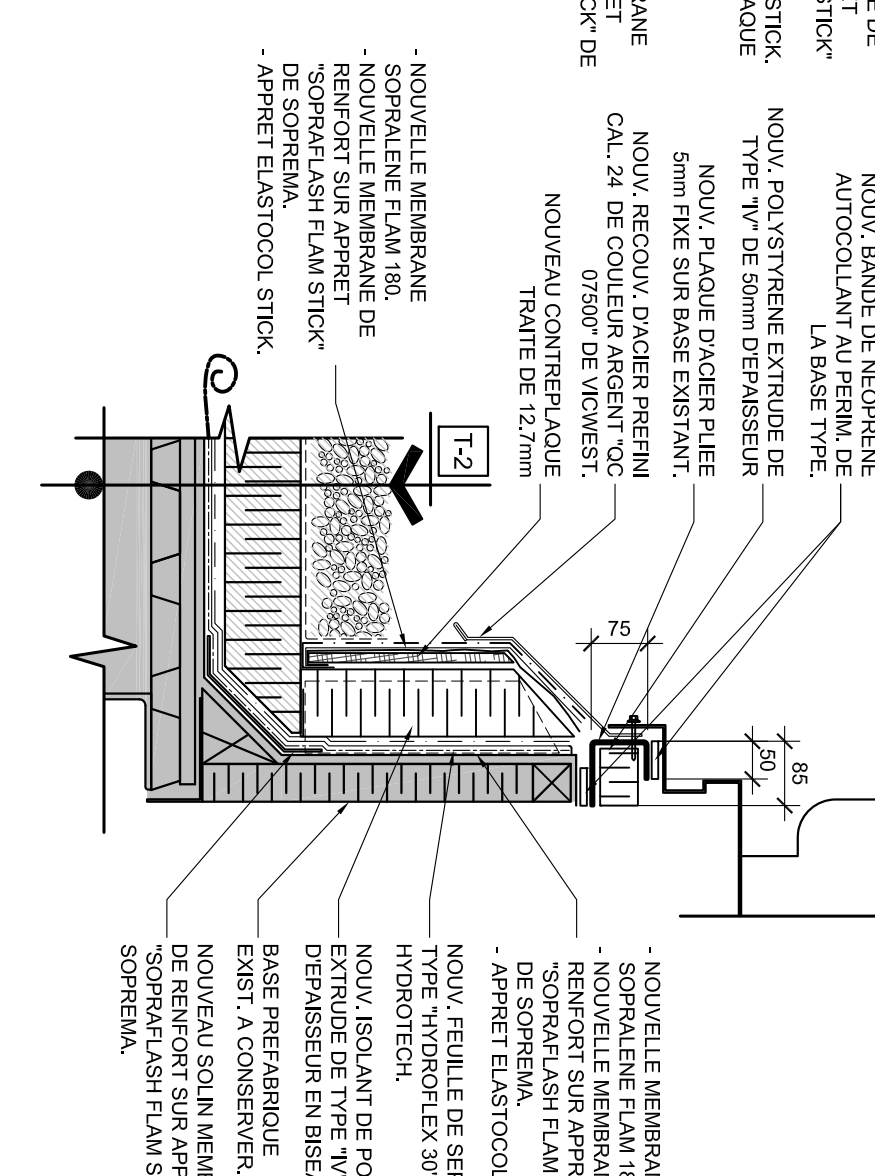

DETAIL TYPE
PAPPAPET EXISTANT
 ECHELLE : 1:10

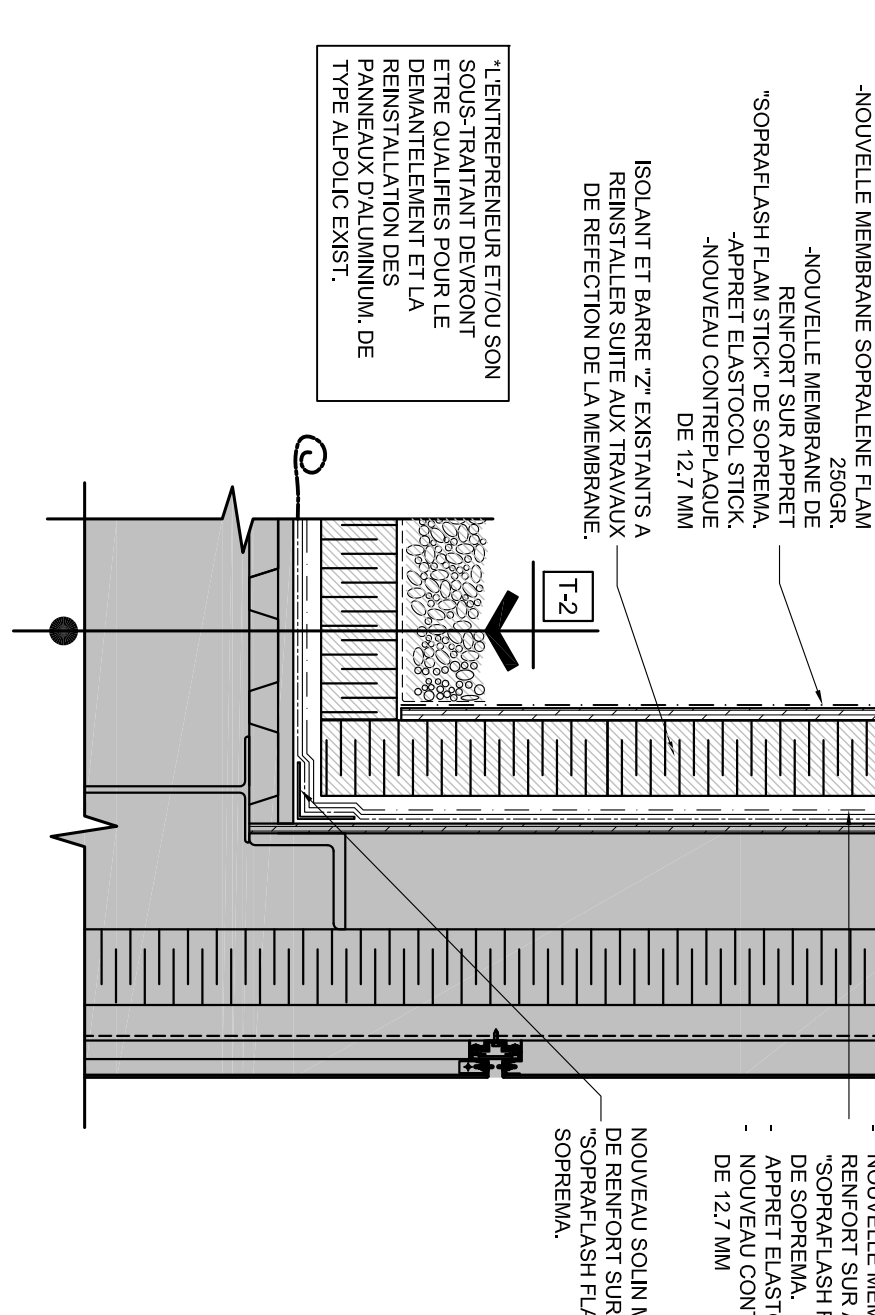

DETAIL TYPE
JONCTION TOIT APPENTIS
 ECHELLE : 1:10

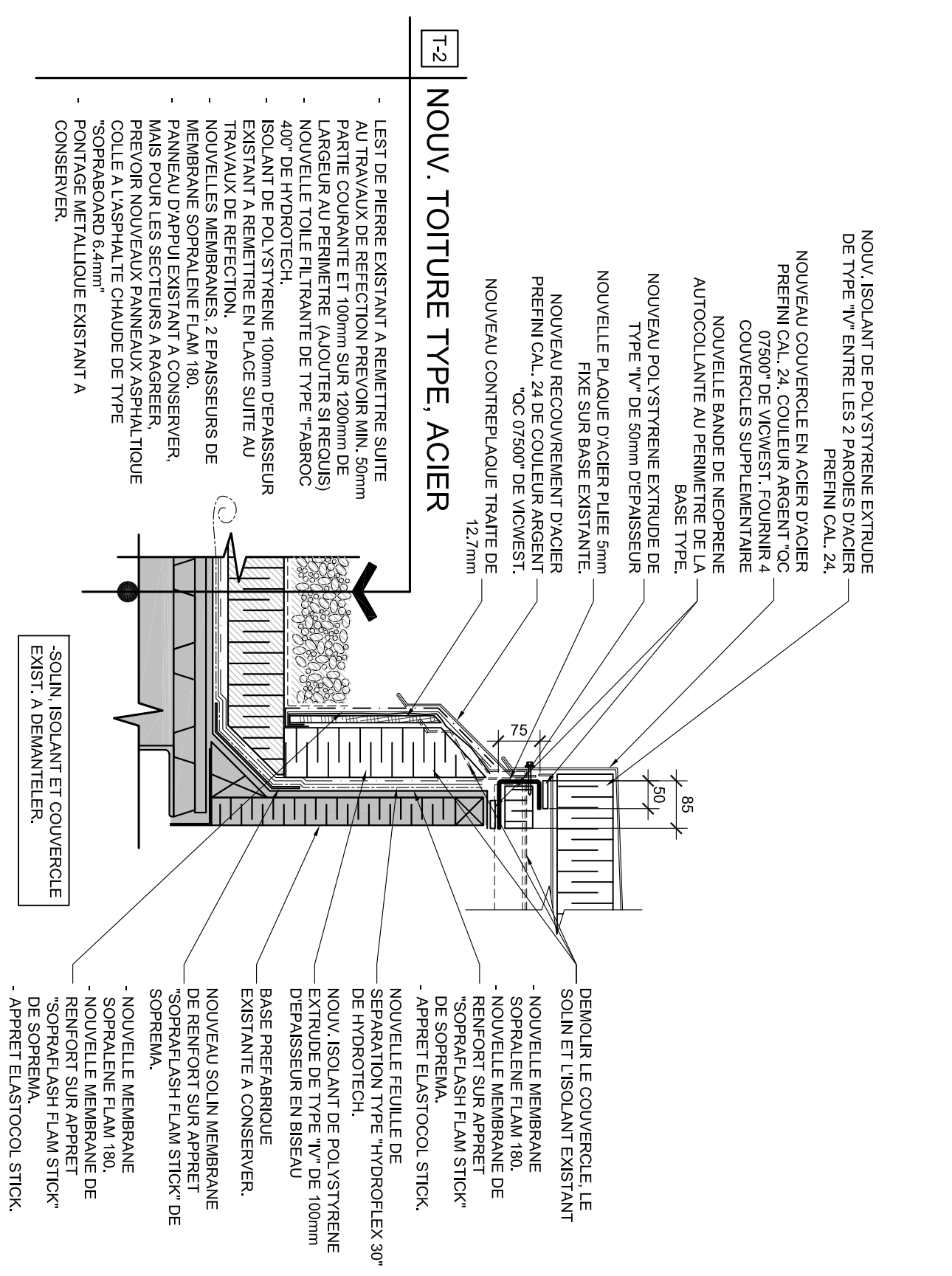
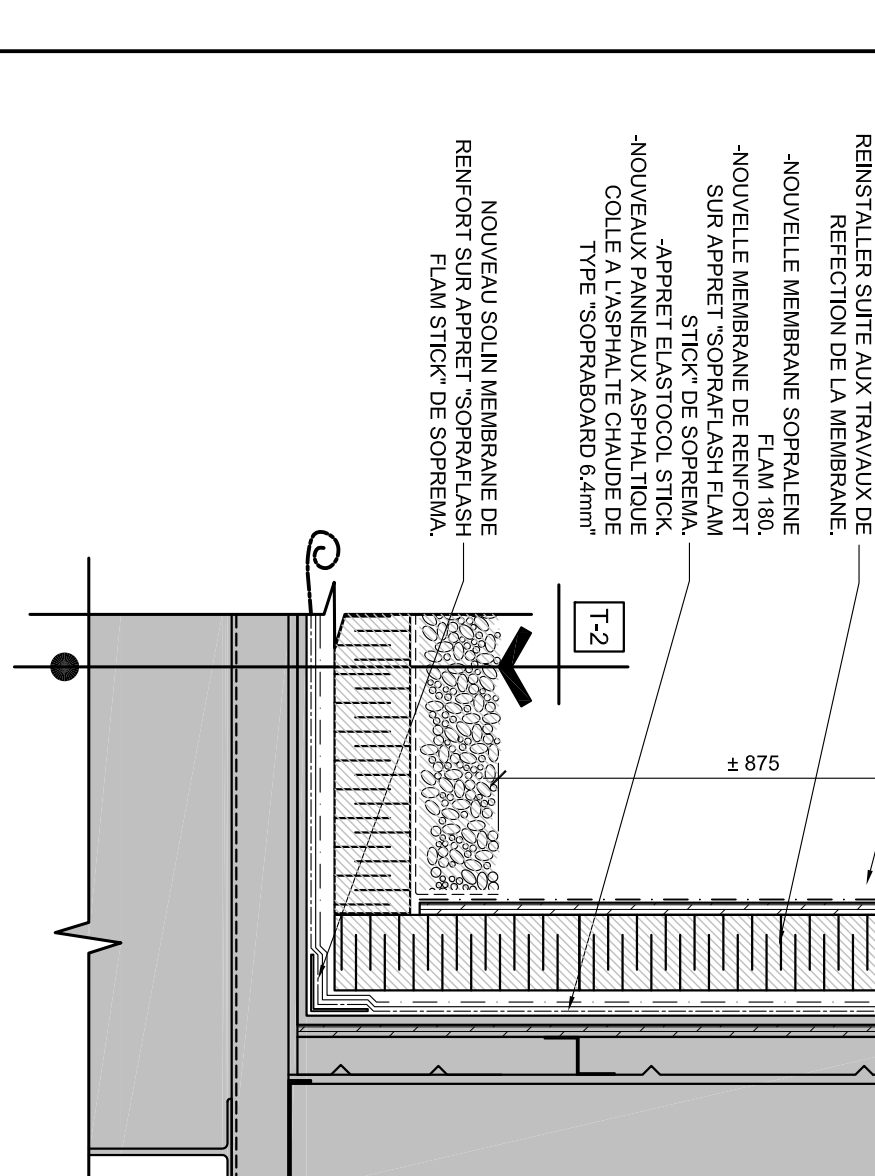

DETAIL TYPE
SORTIES AVEC COUVERCLE
 ECHELLE : 1:10

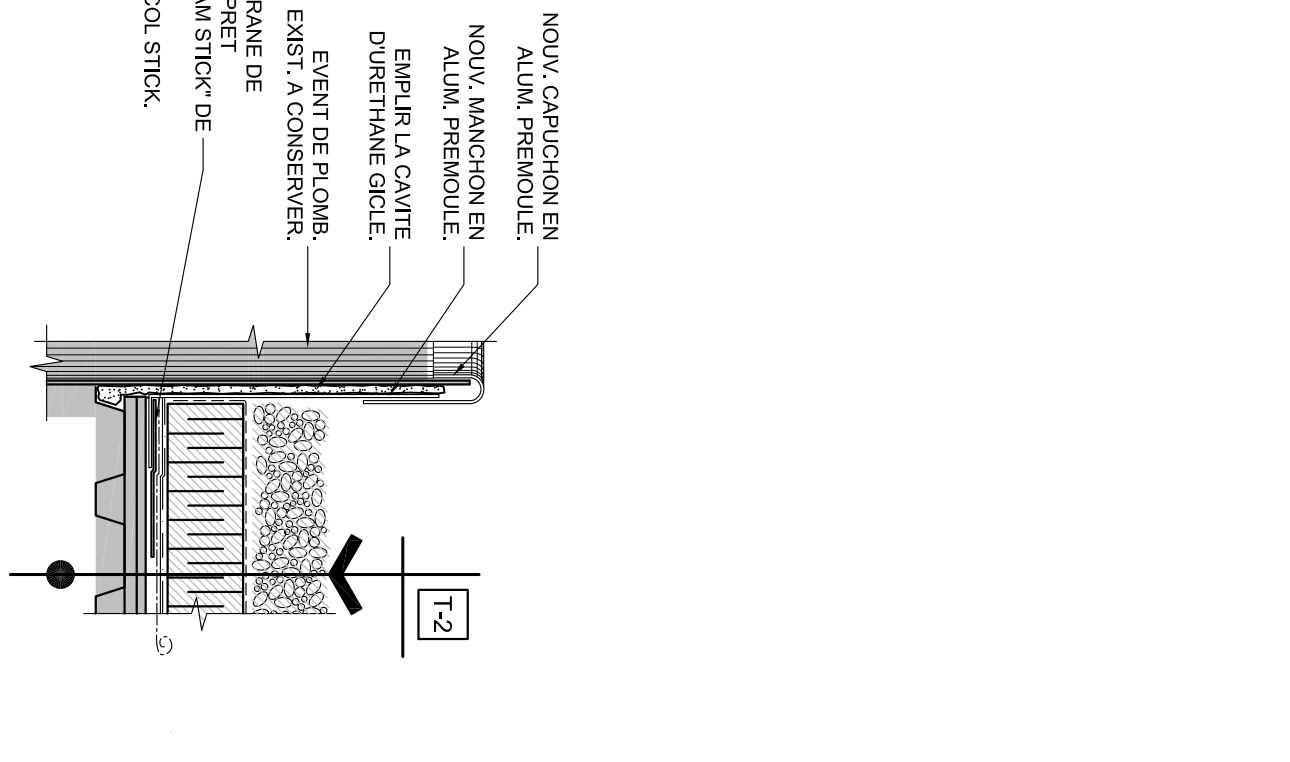

DETAIL TYPE
NOUVEAU DRAIN TOITURE
 ECHELLE : 1:1-1/2"

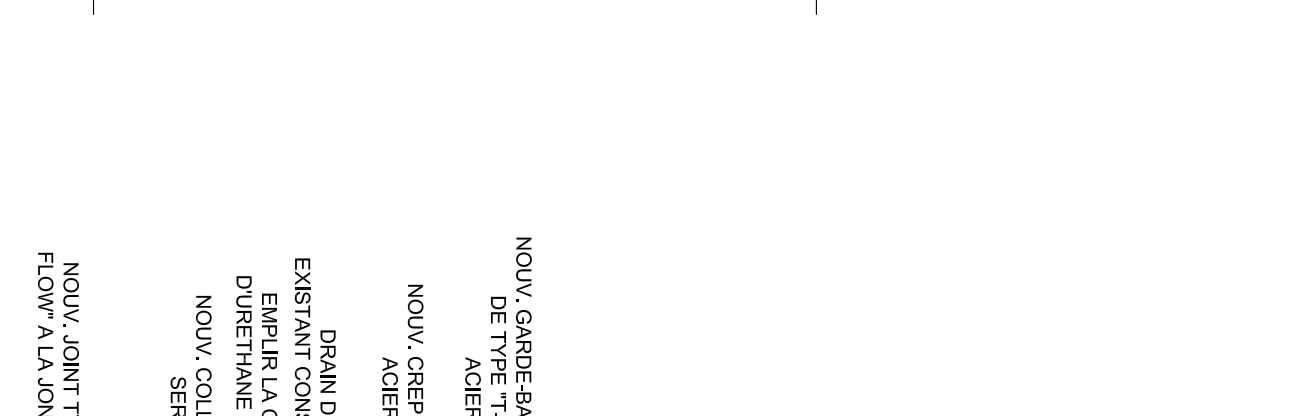

DETAIL TYPE
ETANCHÉITE DORMANT EXISTANT
 ECHELLE : 1:1-1/2"

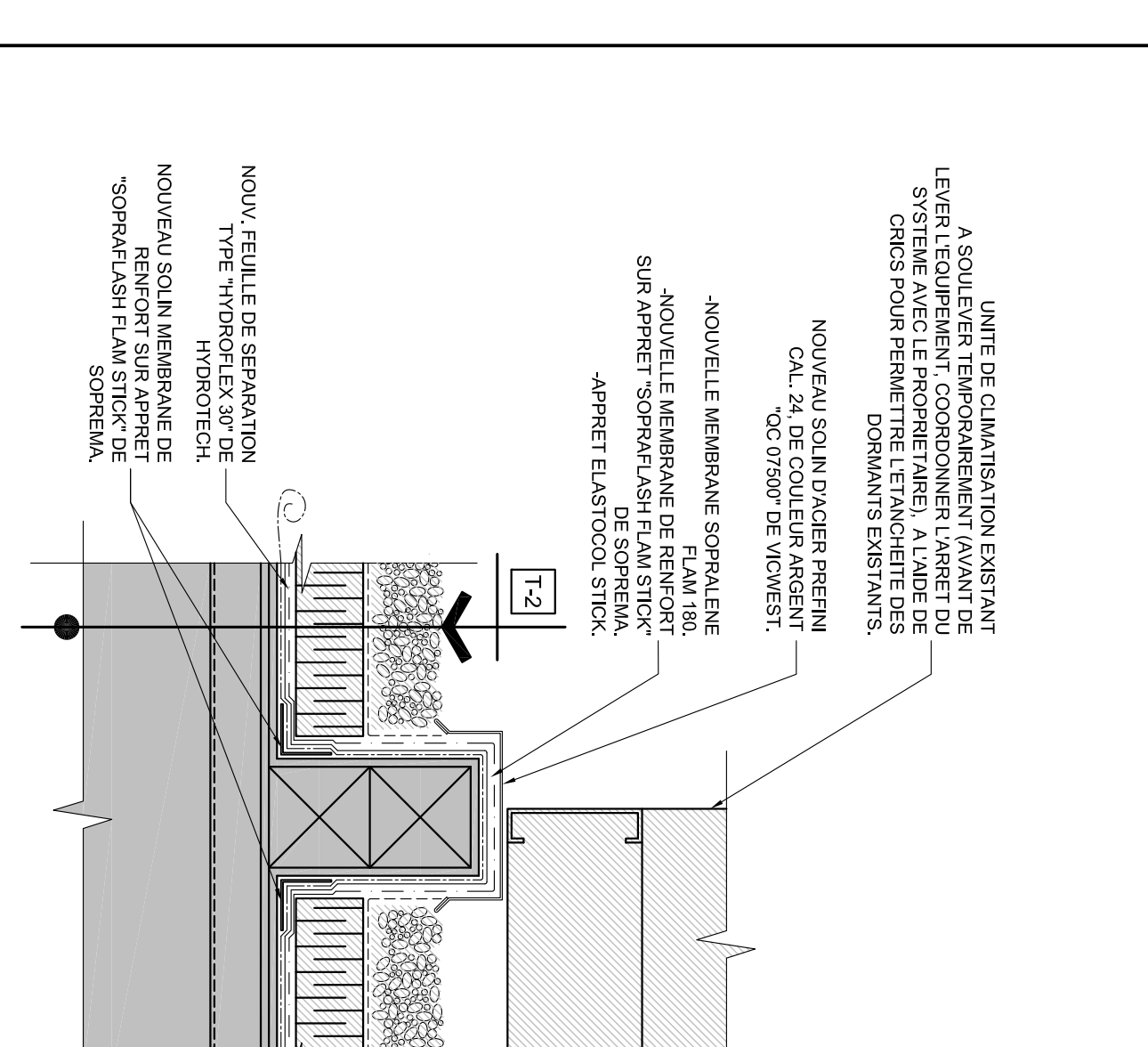

designé	compilé	date	date
M.F.	DECEMBRE 2014		
drawn	dessiné	scale	échelle
F.B.	INDOUEE		
checked	vérifié	sheet	feuille
M.F.	AS 6/16	5	
approved	approuvé	W.O. no.	D.T. no.
M.F.			
drawn	dessin no.		
	14125		

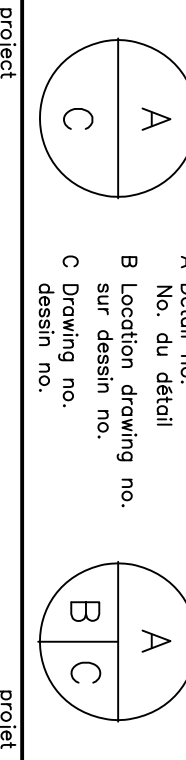

PROJECT
REFECTION DES TOITURES
SECTEUR L1 - L2 ET GARAGE
PROJET 14125
M. BOUCHEMILLE

drawing

SECTEUR 4 ET 5
DETAIL TYPE

o Verify all dimensions and site conditions and be responsible for same
 o Vérifier toutes les dimensions et l'état des lieux et en assumer la responsabilité