

## INVITATION TO TENDER

**RETURN BIDS TO:**

**Bid Receiving / Agriculture and Agri-Food Canada**

Agriculture and Agri-Food Canada  
 Eastern Service Centre  
 Tender Receiving Unit  
 2001 University Street., Suite 671-TEN  
 Montréal, Quebec  
 H3A 3N2

**TENDER TO:**

**Agriculture and Agri-Food Canada**

We hereby offer to sell to Her Majesty the Queen in right of Canada, in accordance with the terms and conditions set out herein, referred to herein or attached hereto, the construction listed herein and on any attached sheets at the price(s) set out therefor.

Comments

Title London Paving Project				
Solicitation No. 01B46-15-0065			Date 2015-07-08	
Client Reference No. 1516-143910-20				
File No. 01B46-15-0065				
Solicitation Closes:				
Day of Week Thursday	Month July	Day 23	Year 2015	Time 02:00
Time of Day <input type="radio"/> AM <input checked="" type="radio"/> PM			Time Zone EDT	
F.O.B. <input type="radio"/> Plant <input checked="" type="radio"/> Destination <input type="radio"/> Other				
Address Enquiries to: Gabriel Le Plouffe				
Title: Contracting Officer				
Email: gabriel.leplouffe@agr.gc.ca				
Telephone Number 514 315-6123		Ext. 	Fax Number 514 283-3143	
Destination Agriculture and Agri-Food Canada Southern Crop Protection and Food Research Centre 1391 Sandford Street London, Ontario, N5V 4T3				

**Instructions: See Herein**

Delivery Required October 15, 2015		Delivery Offered
Vendor / Firm Name and Address		
Telephone Number		Ext.
Telephone Number		Fax Number

**ISSUING OFFICE**

Agriculture and Agri-Food Canada  
 Eastern Service Centre  
 Tender Receiving Unit  
 2001 University Street., Suite 671-TEN  
 Montréal, Quebec  
 H3A 3N2

Name and title of person authorized to sign on behalf of Vendor / Firm  
(type or print)

\_\_\_\_\_  
Signature

\_\_\_\_\_  
Date



## Appendix "A"

### GENERAL INSTRUCTIONS TO BIDDERS

## GENERAL INSTRUCTIONS TO BIDDERS

- GI01 Completion of Bid
- GI02 Identity or Legal Capacity of the Bidder
- GI03 Applicable Taxes
- GI04 Capital Development and Redevelopment Charges
- GI05 Registry and Pre-qualification of Floating Plant
- GI06 Listing of Subcontractors and Suppliers
- GI07 Bid Security Requirements
- GI08 Submission of Bid
- GI09 Revision of Bid
- GI10 Rejection of Bid
- GI11 Bid Costs
- GI12 Compliance with Applicable Laws
- GI13 Approval of Alternative Materials
- GI14 Conflict of Interest – Unfair Advantage

### **GI01 COMPLETION OF BID**

- 1) The bid shall be:
  - (a) submitted on the BID AND ACCEPTANCE FORM provided by AAFC with the bid package or on a clear and legible reproduced copy of such BID AND ACCEPTANCE FORM that must be identical in content and format to the BID AND ACCEPTANCE FORM provided by AAFC;
  - (b) based on the Bid Documents listed in the Special Instructions to Bidders;
  - (c) correctly completed in all respects;
  - (d) signed, with an original signature, by a duly authorized representative of the Bidder; and
  - (e) accompanied by
    - (i) bid security as specified in GI07; and
    - (ii) any other document or documents specified elsewhere in the solicitation where it is stipulated that said documents are to accompany the bid.
- 2) Subject to paragraph 6) of GI10, any alteration to the pre-printed or pre-typed sections of the Bid and Acceptance Form, or any condition or qualification placed upon the bid shall be cause for disqualification. Alterations, corrections, changes or erasures made to statements or figures entered on the Bid and Acceptance Form by the Bidder shall be initialed by the person or persons signing the bid. Alterations, corrections, changes or erasures that are not initialed shall be deemed void and without effect.
- 3) Unless otherwise noted elsewhere in the Bid Documents, facsimile copies of bids are not acceptable.

## **GENERAL INSTRUCTIONS TO BIDDERS (Continued)**

### **GI02 IDENTITY OR LEGAL CAPACITY OF THE BIDDER**

- 1) In order to confirm the authority of the person or persons signing the bid or to establish the legal capacity under which the Bidder proposes to enter into Contract, any Bidder who carries on business in other than its own personal name shall, if requested by Canada, provide satisfactory proof of
  - (a) such signing authority; and
  - (b) the legal capacity under which it carries on business;

prior to contract award. Proof of signing authority may be in the form of a certified copy of a resolution naming the signatory(ies) that is (are) authorized to sign this bid on behalf of the corporation or partnership. Proof of legal capacity may be in the form of a copy of the articles of incorporation or the registration of the business name of a sole proprietor or partnership.

### **GI03 APPLICABLE TAXES**

- 1) "Applicable Taxes" means the Goods and Services Tax (GST), the Harmonized Sales Tax (HST), and any provincial tax, by law, payable by Canada such as, the Quebec Sales Tax (QST) as of April 1, 2013.

### **GI04 CAPITAL DEVELOPMENT AND REDEVELOPMENT CHARGES**

- 1) For the purposes of GC1.8 LAWS, PERMITS AND TAXES in the General Conditions of the Contract, only fees or charges directly related to the processing and issuing of building permits shall be included. The Bidder shall not include any monies in the bid amount for special municipal development, redevelopment or other fees or charges which a municipal authority may seek as a prerequisite to the issuance of building permits.

### **GI05 REGISTRY AND PRE-QUALIFICATION OF FLOATING PLANT**

- 1) Dredges or other floating plant to be used in the performance of the Work must be of Canadian registry. For dredges or other floating plant that are not of Canadian make or manufacture, the Bidder must obtain a certificate of qualification from Industry Canada and this certificate must accompany the bid. Plant so qualified by Industry Canada may be accepted on this project.

### **GI06 LISTING OF SUBCONTRACTORS AND SUPPLIERS**

- 1) Notwithstanding any list of Subcontractors that the Bidder may be required to submit as part of the bid, the Bidder shall, within 48 hours of receipt of a notice to do so, submit all information requested in the said notice including the names of Subcontractors and Suppliers for the part or parts of the Work listed. Failure to do so shall result in the disqualification of its bid.

### **GI07 BID SECURITY REQUIREMENTS**

- 1) The Bidder shall submit bid security with the bid in the form of a bid bond or a security deposit in an amount that is equal to not less than 10 percent of the bid amount. Applicable Taxes shall not be included when calculating the amount of any bid security that may be required. The maximum amount of bid security required with any bid is \$2,000,000.00.

## GENERAL INSTRUCTIONS TO BIDDERS (Continued)

- 2) A bid bond shall be in an approved form <http://www.tbs-sct.gc.ca/pol/doc-eng.aspx?id=14494&section=text#appS>, properly completed, with original signature(s) and issued by an approved company whose bonds are acceptable to Canada either at the time of solicitation closing or as identified in Treasury Board Appendix L: [Acceptable Bonding Companies](#).
- 3) A security deposit shall be an original, properly completed, signed where required and be either:
  - (a) a bill of exchange, bank draft or money order made payable to the Receiver General for Canada and certified by an approved financial institution or drawn by an approved financial institution on itself; or
  - (b) bonds of, or unconditionally guaranteed as to principal and interest by, the Government of Canada;
- 4) For the purposes of subparagraph 3) (a) of GI07
  - (a) a bill of exchange is an unconditional order in writing signed by the Bidder and addressed to an approved financial institution, requiring the said institution to pay, on demand, at a fixed or determinable future time a sum certain of money to, or to the order of, the Receiver General for Canada;
  - (b) if a bill of exchange, bank draft or money order is certified by or drawn on an institution or corporation other than a chartered bank, it must be accompanied by proof that the said institution or corporation meets at least one of the criteria described in subparagraph 4.c. of GI07, either by letter or by a stamped certification on the bill of exchange, bank draft or money; and
  - (c) An approved financial institution is:
    - (i) a corporation or institution that is a member of the Canadian Payments Association as defined in the [Canadian Payments Act](#);
    - (ii) a corporation that accepts deposits that are insured, to the maximum permitted by law, by the Canada Deposit Insurance Corporation or the "Autorité des marchés financiers";
    - (iii) a corporation that accepts deposits from the public if repayment of the deposit is guaranteed by Her Majesty the Queen in right of a province;
    - (iv) a corporation, association or federation incorporated or organized as a credit union or co-operative credit society that conforms to the requirements of a credit union which are more particularly described in paragraph 137(6) of the [Income Tax Act](#); or
    - (v) Canada Post Corporation.
- 5) Bonds referred to in subparagraph 3)(b) of GI07 shall be provided on the basis of their market value current at the date of solicitation closing, and shall be:
  - (a) payable to bearer;
  - (b) accompanied by a duly executed instrument of transfer of the bonds to the Receiver General for Canada in the form prescribed by the Domestic Bonds of Canada Regulations; or
  - (c) registered as to principal or as to principal and interest in the name of the Receiver General for Canada pursuant to the Domestic Bonds of Canada Regulations.

## GENERAL INSTRUCTIONS TO BIDDERS (Continued)

- 6) As an alternative to a security deposit an irrevocable standby letter of credit is acceptable to Canada and the amount shall be determined in the same manner as a security deposit referred to above.
- 7) An irrevocable standby letter of credit referred to in paragraph 6) of GI07 shall
  - (a) be an arrangement, however named or described, whereby a financial institution (the "Issuer") acting at the request and on the instructions of a customer (the "Applicant) or on its own behalf,
    - (i) is to make a payment to, or to the order of, the Receiver General for Canada as the beneficiary;
    - (ii) is to accept and pay bills of exchange drawn by the Receiver General for Canada;
    - (iii) authorizes another financial institution to effect such payment or accept and pay such bills of exchange; or
    - (iv) authorizes another financial institution to negotiate against written demand(s) for payment provided that the terms and conditions of the letter of credit are complied with;
  - (b) state the face amount which may be drawn against it;
  - (c) state its expiry date;
  - (d) provide for sight payment to the Receiver General for Canada by way of the financial institution's draft against presentation of a written demand for payment signed by the Departmental Representative identified in the letter of credit by his/her office;
  - (e) provide that more than one written demand for payment may be presented subject to the sum of those demands not exceeding the face value of the letter of credit;
  - (f) provide that it is subject to the International Chamber of Commerce (ICC) Uniform Customs and Practice (UCP) for Documentary Credits, 2007 Revision, ICC Publication No. 600; pursuant to the ICC UCP; a credit is irrevocable even if there is no indication to that effect; and
  - (g) be issued or confirmed, in either official language, by a financial institution which is a member of the Canadian Payments Association and is on the letterhead of the Issuer or Confirmer. The format is left to the discretion of the Issuer or Confirmer.
- 8) Bid security shall lapse or be returned as soon as practical following:
  - (a) the solicitation closing date, for those Bidders submitting non-compliant bids; and
  - (b) the administrative bid review, for those Bidders submitting compliant bids ranked fourth to last on the schedule of bids; and
  - (c) the award of contract, for those Bidders submitting the second and third ranked bids; and
  - (d) the receipt of contract security, for the successful Bidder; or
  - (e) the cancellation of the solicitation, for all Bidders.
- 9) Notwithstanding the provisions of paragraph 8) of GI07 and provided more than three compliant bids have been received, if one or more of the bids ranked third to first is withdrawn or rejected

## **GENERAL INSTRUCTIONS TO BIDDERS (Continued)**

for whatever reason then Canada reserves the right to hold the security of the next highest ranked compliant bid in order to retain the bid security of at least three valid and compliant bids.

### **GI08 SUBMISSION OF BID**

- 1) The Bid and Acceptance Form, duly completed, and the bid security shall be enclosed and sealed in an envelope provided by the Bidder, and shall be addressed and submitted to the office designated on the INVITATION TO TENDER Form for the receipt of bids. The bid must be received on or before the date and time set for solicitation closing.
- 2) Unless otherwise specified in the Special Instructions to Bidders
  - (a) the bid shall be in Canadian currency;
  - (b) exchange rate fluctuation protection is not offered; and
  - (c) any request for exchange rate fluctuation protection shall not be considered.
- 3) Prior to submitting the bid, the Bidder shall ensure that the following information is clearly printed or typed on the face of the bid envelope:
  - (a) Solicitation Number;
  - (b) Name of Bidder;
  - (c) Return address; and
  - (d) Closing Date and Time.
- 4) Timely and correct delivery of bids is the sole responsibility of the Bidder.

### **GI09 REVISION OF BID**

- 1) A bid submitted in accordance with these instructions may be revised by letter or facsimile provided the revision is received at the office designated for the receipt of bids, on or before the date and time set for the closing of the solicitation. The letter or facsimile shall be on the Bidder's letterhead or bear a signature that identifies the Bidder;
- 2) A revision to a bid that includes unit prices must clearly identify the changes(s) in the unit price(s) and the specific item(s) to which each change applies.
- 3) A letter or facsimile submitted to confirm an earlier revision shall be clearly identified as a confirmation.
- 4) Failure to comply with any of the above provisions shall result in the rejection of the non-compliant revision(s) only. The bid shall be evaluated based on the original bid submitted and all other compliant revision(s).

### **GI10 REJECTION OF BID**

- 1) Canada may accept any bid, whether it is the lowest or not, or may reject any or all bids.
- 2) Without limiting the generality of paragraph 1) of GI10, Canada may reject a bid if any of the following circumstances is present:



## GENERAL INSTRUCTIONS TO BIDDERS (Continued)

- (a) the Bidder, or any employee or subcontractor included as part of the bid, has been convicted under Section 121 ("Frauds on the government" & "Contractor subscribing to election fund"), 124 "Selling or purchasing office"), 380 ("Fraud committed against Her Majesty") or 418 ("Selling defective stores to Her Majesty") of the Criminal Code of Canada, or under paragraph 80(1)(d) ("False entry, certificate or return"), subsection 80(2) ("Fraud against Her Majesty") or Section 154.01 ("Fraud against Her Majesty") of the *Financial Administration Act*;
  - (b) the Bidder's bidding privileges are suspended or are in the process of being suspended;
  - (c) the bidding privileges of any employee or subcontractor included as part of the bid are suspended or are in the process of being suspended, which suspension or pending suspension would render that employee or subcontractor ineligible to bid on the Work, or the portion of the Work the employee or subcontractor is to perform;
  - (d) the Bidder is bankrupt, or where for whatever reason, its activities are rendered inoperable for an extended period;
  - (e) evidence, satisfactory to Canada, of fraud, bribery, fraudulent misrepresentation or failure to comply with any law protecting individuals against any manner of discrimination, has been received with respect to the Bidder, any of its employees or any subcontractor included as part of its bid;
  - (f) evidence satisfactory to Canada that based on past conduct or behavior, the Bidder, a sub-contractor or a person who is to perform the Work is unsuitable or has conducted himself/herself improperly;
  - (g) with respect to current or prior transactions with Canada
    - (i) Canada has exercised, or intends to exercise, the contractual remedy of taking the work out of the contractor's hands with respect to a contract with the Bidder, any of its employees or any subcontractor included as part of its bid; or
    - (ii) Canada determines that the Bidder's performance on other contracts is sufficiently poor to jeopardize the successful completion of the requirement being bid on.
- 3) In assessing the Bidder's performance on other contracts pursuant to subparagraph 2)(g)(ii) of GI10, Canada may consider, but not be limited to, such matters as:
- (a) the quality of workmanship in performing the Work;
  - (b) the timeliness of completion of the Work;
  - (c) the overall management of the Work and its effect on the level of effort demanded of the department and its representative; and
  - (d) the completeness and effectiveness of the Contractor's safety program during the performance of the Work.
- 4) Without limiting the generality of paragraphs 1), 2) and 3) of GI10, Canada may reject any bid based on an unfavourable assessment of the:
- (a) adequacy of the bid price to permit the work to be carried out and, in the case of a bid

## **GENERAL INSTRUCTIONS TO BIDDERS (Continued)**

providing prices per unit or a combination of lump sum and prices per unit, whether each such price reasonably reflects the cost of performing the part of the work to which that price applies;

- (b) Bidder's ability to provide the necessary management structure, skilled personnel, experience and equipment to perform competently the work under the Contract; and
  - (c) Bidder's performance on other contracts.
- 5) Where Canada intends to reject a bid pursuant to a provision of paragraphs 1), 2), 3) or 4) of GI10, other than subparagraph 2)(g) of IT10, the contracting authority will inform the Bidder and provide the Bidder ten (10) days within which to make representations, before making a final decision on the bid rejection.
- 6) Canada may waive informalities and minor irregularities in bids received if Canada determines that the variation of the bid from the exact requirements set out in the Bid Documents can be corrected or waived without being prejudicial to other Bidders.

### **GI11 BID COSTS**

- 1) No payment will be made for costs incurred in the preparation and submission of a bid in response to the bid solicitation. Costs associated with preparing and submitting a bid, as well as any costs incurred by the Bidder associated with the evaluation of the bid, are the sole responsibility of the Bidder.

### **GI12 COMPLIANCE WITH APPLICABLE LAWS**

- 1) By submission of a bid, the Bidder certifies that the Bidder has the legal capacity to enter into a contract and is in possession of all valid licences, permits, registrations, certificates, declarations, filings, or other authorizations necessary to comply with all federal, provincial and municipal laws and regulations applicable to the submission of the bid and entry into any ensuing contract for the performance of the work.
- 2) For the purpose of validating the certification in paragraph 1) of GI12, a Bidder shall, if requested, provide a copy of every valid licence, permit, registration, certificate, declaration, filing or other authorization listed in the request, and shall provide such documentation within the time limit(s) set out in the said request.
- 3) Failure to comply with the requirements of paragraph 2) of GI12 shall result in disqualification of the bid.

### **GI13 APPROVAL OF ALTERNATIVE MATERIALS**

- 1) When materials are specified by trade names or trademarks, or by manufacturers' or suppliers' names, the bid shall be based on use of the named materials. During the solicitation period, alternative materials may be considered provided full technical data is received in writing by the Contracting Officer at least 10 calendar days prior to the solicitation closing date.

### **GI14 CONFLICT OF INTEREST - UNFAIR ADVANTAGE**

- 1) In order to protect the integrity of the procurement process, bidders are advised that Canada may reject a bid in the following circumstances:

## GENERAL INSTRUCTIONS TO BIDDERS (Continued)

- (a) if the Bidder, any of its subcontractors, any of their respective employees or former employees was involved in any manner in the preparation of the bid solicitation or in any situation of conflict of interest or appearance of conflict of interest;
  - (b) if the Bidder, any of its subcontractors, any of their respective employees or former employees had access to information related to the bid solicitation that was not available to other bidders and that would, in Canada's opinion, give or appear to give the Bidder an unfair advantage.
- 2) The experience acquired by a bidder who is providing or has provided the goods and services described in the bid solicitation (or similar goods or services) will not, in itself, be considered by Canada as conferring an unfair advantage or creating a conflict of interest. This bidder remains however subject to the criteria established above.
- 3) Where Canada intends to reject a bid under this section, the Contracting Authority will inform the Bidder and provide the Bidder an opportunity to make representations before making a final decision. Bidders who are in doubt about a particular situation should contact the Contracting Authority before bid closing. By submitting a bid, the Bidder represents that it does not consider itself to be in conflict of interest nor to have an unfair advantage. The Bidder acknowledges that it is within Canada's sole discretion to determine whether a conflict of interest, unfair advantage or an appearance of conflict of interest or unfair advantage exists.



## Appendix "B"

### SPECIAL INSTRUCTIONS TO BIDDERS

## SPECIAL INSTRUCTIONS TO BIDDERS (SI)

SI01	Bid Documents
SI02	Enquiries during the Solicitation Period
SI03	Non-Mandatory Site Visit
S104	Revision of Bid
S105	Bid Results
SI06	Insufficient Funds
SI07	Bid Validity Period
SI08	Construction Documents
SI09	Web Sites
SI10	Personnel Security Requirements

### SI01 BID DOCUMENTS

- 1) The following are the bid documents:
  - (a) INVITATION TO TENDER - Page 1 form AAFC / AAC5323-E;
  - (b) SPECIAL INSTRUCTIONS TO BIDDERS form AAFC / AAC5301-E;
  - (c) GENERAL INSTRUCTIONS TO BIDDERS form AAFC / AAC5313-E;
  - (d) Clauses and Conditions identified in "CONTRACT DOCUMENTS";
  - (e) Drawings and Specifications;
  - (f) BID AND ACCEPTANCE form AAFC / AAC5320-E and any Appendices attached thereto; and,
  - (g) Any amendment issued prior to solicitation closing.

Submission of a bid constitutes acknowledgement that the Bidder has read and agrees to be bound by these documents.

### SI02 ENQUIRIES DURING THE SOLICITATION PERIOD

- 1) Enquiries regarding this bid must be submitted in writing to the Contracting Officer named on the INVITATION TO TENDER - Page 1 as early as possible within the solicitation period. Except for the approval of alternative materials as described in G113 of the GENERAL INSTRUCTIONS TO BIDDERS, enquiries should be received no later than five (5) calendar days prior to the date set for solicitation closing to allow sufficient time to provide a response. Enquiries received after that time may not result in an answer being provided.
- 2) To ensure consistency and quality of the information provided to Bidders, the Contracting Officer shall examine the content of the enquiry and shall decide whether or not to issue an amendment.
- 3) All enquiries and other communications related to this bid sent throughout the solicitation period are to be directed ONLY to the Contracting Officer named on the INVITATION TO TENDER - Page 1. Non-compliance with this requirement during the solicitation period can, for that reason alone, result in disqualification of a bid.

### SI03 NON-MANDATORY SITE VISIT

- 1) There will be a site visit on Thursday, July, 16, 2015 at 09:30  AM  PM Local Standard Time.

## **SPECIAL INSTRUCTIONS TO BIDDERS (Continued)**

Interested bidders are to meet at:

Agriculture and Agri -Food Canada  
Southern Crop Protection and Food Research Centre  
1391 Sandford Street  
London, Ontario, N5V 4T3

### **SI04 REVISION OF BID**

- 1) A bid may be revised by letter or facsimile in accordance with GI09 of the GENERAL INSTRUCTIONS TO BIDDERS. The facsimile number for receipt of revisions is 514 283-3143 .

### **SI05 BID RESULTS**

- 1) Following bid closing, bid results may be obtained from the bid receiving office by email at gabriel.leplouffe@agr.gc.ca .

### **SI06 INSUFFICIENT FUNDING**

- 1) In the event that the lowest compliant bid exceeds the amount of funding allocated for the Work, Canada in its sole discretion may:
  - (a) cancel the solicitation; or
  - (b) obtain additional funding and award the Contract to the Bidder submitting the lowest compliant bid; and/or
  - (c) negotiate a reduction in the bid price and/or scope of work of not more than 15% with the Bidder submitting the lowest compliant bid. Should an agreement satisfactory to Canada not be reached, Canada shall exercise option (a) or (b).

### **SI07 BID VALIDITY PERIOD**

- 1) Canada reserves the right to seek an extension to the bid validity period prescribed in Clause 4 of the BID AND ACCEPTANCE Form. Upon notification in writing from Canada, Bidders shall have the option to either accept or reject the proposed extension.
- 2) If the extension referred to in paragraph 1) of SI07 is accepted, in writing, by all those who submitted bids, then Canada shall continue immediately with the evaluation of the bids and its approvals processes.
- 3) If the extension referred to in paragraph 1) of SI07 is not accepted in writing by all those who submitted bids then Canada shall, at its sole discretion, either:
  - (a) continue to evaluate the bids of those who have accepted the proposed extension and seek the necessary approvals; or
  - (b) cancel the invitation to bid.
- 4) The provisions expressed herein do not in any manner limit Canada's rights in law or under GI10 of the GENERAL INSTRUCTIONS TO BIDDERS.

## **SPECIAL INSTRUCTIONS TO BIDDERS (Continued)**

### **SI08 CONSTRUCTION DOCUMENTS**

- 1) The successful contractor will be provided with one paper copy of the sealed and signed plans, the specifications and the amendments upon acceptance of the offer. Additional copies, up to a maximum of one ( 1 ), will be provided free of charge upon request by the Contractor. Obtaining more copies shall be the responsibility of the Contractor including costs.

### **SI09 WEB SITES**

The connection to some of the Web sites in the solicitation documents is established by the use of hyperlinks. The following is a list of the addresses of the Web sites:

Treasury Board Appendix L, Acceptable Bonding Companies

<http://www.tbs-sct.gc.ca/pol/doc-eng.aspx?id=14494&section=text#appL>

Canadian economic sanctions

<http://www.international.gc.ca/sanctions/index.aspx?lang=eng>

### **SI10 PERSONNEL SECURITY REQUIREMENTS**

- 1) The successful Bidder's personnel, as well as any subcontractor and its personnel, who are required to perform any part of the work pursuant to the subsequent contract, must meet the following contract security requirements:
  - Unscreened personnel may be used for the work. Unscreened personnel will require an escort provided by AAFC.



## Appendix "C"

### BID AND ACCEPTANCE FORM



## BID AND ACCEPTANCE FORM

### CONSTRUCTION CONTRACT - MAJOR WORKS

<b>BA01 IDENTIFICATION</b>					
Description of the Work Paving project at the Southern Crop Protection and Food Research Centre in London, Ontario.					
Solicitation Number 01B46-15-0065			File / Project Number 1516-143910-20		
<b>BA02 BUSINESS NAME AND ADDRESS OF BIDDER</b>					
Name					
Address					
Unit/Suite/Apt.	Street number	Number suffix	Street name	Street type	Street direction
PO Box or Route Number			Municipality (City, Town, etc.)	Province	Postal code
Phone number		Fax number		Email address	
<b>BA03 THE OFFER</b>					
1) The Bidder offers to Canada as represented by the Minister of Agriculture and Agri-food Canada to perform and complete the Work for the above named project in accordance with the Bid Documents for the Total Bid Amount of: \$ _____ excluding Applicable Taxes (GST/HST/QST). (to be expressed in numbers only)					
<b>BA04 BID VALIDITY PERIOD</b>					
1) The bid shall not be withdrawn for a period of <u>60</u> days following the date of solicitation closing.					
<b>BA05 APPENDICES</b>					
1) The following appendices are included in this Bid and Acceptance Form: <input checked="" type="checkbox"/> Appendix 2					
<b>BA06 ACCEPTANCE AND CONTRACT</b>					
1) Upon acceptance of the Bidder's offer by Canada, a binding Contract shall be formed between Canada and the resulting Contractor. The documents forming the Contract shall be the contract documents referred to in SC01 CONTRACT DOCUMENTS.					
<b>BA07 CONSTRUCTION TIME</b>					
1) The Contractor shall perform and complete the Work <u>on or before 2015-10-15</u>					
<b>BA08 BID SECURITY</b>					
1) The Bidder shall enclose bid security with its bid in accordance with GI07 BID SECURITY REQUIREMENTS.					
2) If a security deposit is furnished as bid security, it shall be forfeited in the event that the bid is accepted by Canada and the Contractor fails to provide Contract Security in accordance with GC9 CONTRACT SECURITY, provided that Canada may, if it is in the public interest, waive the right of Canada to forfeiture any or all of the security deposit.					

**BA09 SIGNATURE**

Name and title of person authorized to sign on behalf of Bidder (type or print)	Name
	Title
	Signature _____ Date _____
	Name
	Title
	Signature _____ Date _____

**BID AND ACCEPTANCE FORM**  
CONSTRUCTION CONTRACT - MAJOR WORKS  
APPENDIX 2

**LIST OF SUBCONTRACTORS**

The Bidder will subcontract the parts of the work listed below to the subcontractor named for each part. The Bidder agrees not to make changes in the list of subcontractors without the written consent of the Departmental Representative. The Bidder understands that for each part of the work, if more than one subcontractor is named, or no subcontractor is named, or, the Bidder fails to state that the work will be done by its own forces where applicable, the bid will be subject to disqualification.

**LIST OF EQUIPMENT**

N/A

**LIST OF MATERIALS**

N/A



## Appendix "D"

### MAJOR WORKS - GENERAL CONDITIONS



**MAJOR WORKS – GENERAL CONDITIONS**

Page 1 of 54

**MAJOR WORKS GENERAL CONDITIONS FORM AAFC 5321:**

Revision Date

GC1	GENERAL PROVISIONS	Original
GC2	ADMINISTRATION OF THE CONTRACT	Original
GC3	EXECUTION AND CONTROL OF THE WORK	Original
GC4	PROTECTIVE MEASURES	Original
GC5	TERMS OF PAYMENT	Original
GC6	DELAYS AND CHANGES IN THE WORK	Original
GC7	DEFAULT, SUSPENSION OR TERMINATION OF CONTRACT	Original
GC8	DISPUTE RESOLUTION	Original
GC9	CONTRACT SECURITY	Original
GC10	INSURANCE	Original

**GC1 GENERAL PROVISIONS**

- GC1.1 INTERPRETATION
  - GC1.1.1 Headings and References
  - GC1.1.2 Terminology
  - GC1.1.3 Application of Certain Provisions
  - GC1.1.4 Substantial Performance
  - GC1.1.5 Completion
- GC1.2 CONTRACT DOCUMENTS
  - GC1.2.1 General
  - GC1.2.2 Order of Precedence
  - GC1.2.3 Security and Protection of Documents and Work
- GC1.3 STATUS OF THE CONTRACTOR
- GC1.4 RIGHTS AND REMEDIES
- GC1.5 TIME OF THE ESSENCE
- GC1.6 INDEMNIFICATION BY THE CONTRACTOR
- GC1.7 INDEMNIFICATION BY CANADA
- GC1.8 LAWS, PERMITS AND TAXES
- GC1.9 WORKERS' COMPENSATION
- GC1.10 NATIONAL SECURITY
- GC1.11 UNSUITABLE WORKERS
- GC1.12 PUBLIC CEREMONIES AND SIGNS
- GC1.13 CONFLICT OF INTEREST
- GC1.14 AGREEMENTS AND AMENDMENTS
- GC1.15 SUCCESSION
- GC1.16 ASSIGNMENT
- GC1.17 NO BRIBE
- GC1.18 CERTIFICATION - CONTINGENCY FEES
- GC1.19 INTERNATIONAL SANCTIONS

**GC1.1 INTERPRETATION**

**GC1.1.1 Headings and References**

- 1) The headings in the contract documents, other than those in the drawings and specifications, form no part of the Contract but are inserted for convenience of reference only.
- 2) A reference made to a part of the Contract by means of numbers preceded by letters is a reference to the particular part of the Contract that is identified by that combination of letters and numbers and to any other part of the Contract referred to therein.
- 3) A reference to a paragraph or subparagraph followed by an identifying number, letter or combination thereof is, unless specifically stated otherwise, a reference to the paragraph or subparagraph that forms part of the clause within which the reference is made.

**GC1.1.2 Terminology**

- 1) In the Contract

"Applicable Taxes" means the Goods and Services Tax (GST), the Harmonized Sales Tax (HST), and any provincial tax, by law, payable by Canada such as, the Quebec Sales Tax (QST) as of April 1, 2013;

"Canada", "Crown", "Her Majesty" means Her Majesty the Queen in right of Canada;

"Contract" means the contract documents referred to as such therein and every other document specified or referred to in any of them as forming part of the Contract, all as amended by agreement of the parties;

"Contract Amount" means the amount set out in the Contract to be payable to the Contractor for the Work, subject to the terms and conditions of the Contract, exclusive of Applicable Taxes;

"Contract Security" means any security given by the Contractor to Canada in accordance with the Contract;

"Contractor" means the person contracting with Canada to provide or furnish all labour, Material and Plant for the execution of the Work under the Contract, and includes the Contractor's superintendent as designated in writing to Canada.

"Certificate of Completion" means a certificate issued by Canada when the Work reaches Completion;

"Certificate of Measurement" means a certificate issued by Canada certifying the correctness of the final quantities, prices per unit and values of labour, Plant and Material performed, used and supplied by the Contractor for the construction of the part of the Work to which a Unit Price Arrangement applies;

"Certificate of Substantial Performance" means a certificate issued by Canada when the Work reaches Substantial Performance;

"Departmental Representative" means the person designated in the Contract, or by written notice to the Contractor, to act as the Departmental Representative for the purposes of the Contract, and includes a person, designated and authorized in writing by the Departmental Representative to the Contractor;

"herein", "hereby", "hereof", "hereunder" and similar expressions refer to the Contract as a whole and not to any particular section or part thereof;

"Lump Sum Arrangement" means that part of the Contract that prescribes a lump sum as payment for performance of the Work to which it relates;

"Material" includes all commodities, articles, machinery, equipment, fixtures and things required to be furnished in accordance with the Contract for incorporation into the Work;

"person" also includes, unless there is an express stipulation in the Contract to the contrary, any partnership, proprietorship, firm, joint venture, consortium or corporation;

"Plant" includes all tools, implements, machinery, vehicles, structures, equipment, articles and things that are necessary for the performance of the Contract, other than Material and those tools customarily provided by a tradesperson in practicing a trade;

"Subcontractor" means a person having a direct contract with the Contractor, subject to GC3.6 SUBCONTRACTING, to perform a part or parts of the Work, or to supply Material customized for the Work;

"Superintendent" means the employee or representative of the Contractor designated by the Contractor to act pursuant to GC2.6 SUPERINTENDENT;

"Supplementary Conditions" means the part of the Contract that amends or supplements the General Conditions;

"Supplier" means a person having a direct contract with the Contractor to supply Plant or Material not customized for the Work;

"Total Estimated Cost", "Revised Estimated Cost", "Increase (Decrease)" on Page 1 of the Contract or Contract Amendment means an amount used for internal administrative purposes only that comprises the Contract Amount, or the revised Contract Amount, or the amount that would increase or decrease the Contract Amount and the Applicable Taxes as evaluated by the Contracting Authority, and does not constitute tax advice on the part of Canada;

"Unit Price Arrangement" means that part of the Contract that prescribes the product of a price per unit of measurement multiplied by a number of units of measurement for performance of the Work to which it relates;

"Unit Price Table" means the table of prices per unit set out in the Contract;

"Work" means, subject only to any express stipulation in the Contract to the contrary, everything that is necessary to be done, furnished or delivered by the Contractor to perform the Contract in accordance with the contract documents; and

"Working Day" means a day other than a Saturday, Sunday, or a statutory holiday that is observed by the construction industry in the area of the place of the Work.

### **GC1.1.3 Application of Certain Provisions**

- 1) Any provisions of the Contract that are expressly stipulated to be applicable only to a Unit Price Arrangement are not applicable to any part of the Work to which a Lump Sum Arrangement applies.
- 2) Any provisions of the Contract that are expressly stipulated to be applicable only to a Lump Sum Arrangement are not applicable to any part of the Work to which a Unit Price Arrangement applies.

### **GC1.1.4 Substantial Performance**

- 1) The Work shall be considered to have reached Substantial Performance when
  - (a) the Work or a substantial part thereof has passed inspection and testing and is, in the opinion of Canada, ready for use by Canada or is being used for the intended purposes; and
  - (b) the Work is, in the opinion of Canada, capable of completion or correction at a cost of not more than
    - (i) 3 percent of the first \$500,000;
    - (ii) 2 percent of the next \$500,000; and
    - (iii) 1 percent of the balanceof the Contract Amount at the time this cost is calculated.
- 2) Where the Work or a substantial part thereof is ready for use or is being used for the purposes intended and



- (a) the remainder of the Work or a part thereof cannot be completed by the time specified in the Contract, or as amended in accordance with GC6.5 DELAYS AND EXTENSION OF TIME, for reasons beyond the control of the Contractor; or
- (b) Canada and the Contractor agree not to complete a part of the Work within the specified time;

the cost of that part of the Work that was either beyond the control of the Contractor to complete or Canada and the Contractor have agreed not to complete by the time specified, shall be deducted from the value of the Contract referred to in subparagraph 1)(b) of GC1.1.4 and the said cost shall not form part of the cost of the Work remaining to be done in determining Substantial Performance.

**GC1.1.5 Completion**

- 1) The Work shall be deemed to have reached Completion when all labour, Plant and Material required have been performed, used or supplied, and the Contractor has complied with the Contract and all orders and directions made pursuant thereto, all to the satisfaction of Canada.

**GC1.2 CONTRACT DOCUMENTS****GC1.2.1 General**

- 1) The contract documents are complementary, and what is required by any one shall be as binding as if required by all.
- 2) References in the contract documents to the singular shall be considered to include the plural as the context requires.
- 3) Nothing contained in the contract documents shall create a contractual relationship between Canada and any Subcontractor or Supplier, their subcontractors or suppliers, or their agents or employees.

**GC1.2.2 Order of Precedence**

- 1) In the event of any discrepancy or conflict in the contents of the following documents, such documents shall take precedence and govern in the following order:
  - (a) any amendment or variation of the contract documents that is made in accordance with the General Conditions;
  - (b) any amendment issued prior to tender closing;
  - (c) Supplementary Conditions;
  - (d) General Conditions;
  - (e) the duly completed Bid and Acceptance Form when accepted;
  - (f) drawings and specifications.

later dates shall govern within each of the above categories of documents.

- 2) In the event of any discrepancy or conflict in the information contained in the drawings and specifications, the following rules shall apply:
  - (a) specifications shall govern over drawings;
  - (b) dimensions shown in figures on a drawings shall govern where they differ from dimensions scaled from the same drawings; and
  - (c) drawings of larger scale govern over those of smaller scale.

**GC1.2.3 Security and Protection of Documents and Work**

- 1) The Contractor shall guard and protect contract documents, drawings, information, models and copies thereof, whether supplied by Canada or the Contractor, against loss or damage from any cause.
- 2) The Contractor shall keep confidential all information provided to the Contractor by or on behalf of Canada in connection with the Work, and all information developed by the Contractor as part of the Work, and shall not disclose any such information to any person without the written permission of Canada, except that the Contractor may disclose to a subcontractor, authorized in accordance with the Contract, information necessary to the performance of a subcontract. This section does not apply to any information that
  - (a) is publicly available from a source other than the Contractor; or
  - (b) is or becomes known to the Contractor from a source other than Canada, except any source that is known to the Contractor to be under an obligation to Canada not to disclose the information.
- 3) When the Contract, the Work, or any information referred to in paragraph 2) is identified as top secret, secret, confidential, or protected by Canada, the Contractor shall, at all times, take all measures reasonably necessary for the safeguarding of the material so identified, including such measures as may be further specified elsewhere in the Contract or provided, in writing, from time to time by Canada.
- 4) Without limiting the generality of paragraphs 2) and 3) of GC1.2.3, when the Contract, the Work, or any information referred to in paragraph 2) is identified as top secret, secret, confidential or protected by Canada, Canada shall be entitled to inspect the Contractor's premises and the premises of its subcontractors or suppliers and any other person at any tier, for security purposes at any time during the term of the Contract, and the Contractor shall comply with, and ensure that any such subcontractors or suppliers comply with all written instructions issued by Canada dealing with the material so identified, including any requirement that employees of the Contractor and its subcontractors and suppliers and any other person at any tier execute and deliver declarations relating to reliability screenings, security clearances and other procedures.
- 5) The Contractor shall safeguard the Work and the Contract, the specifications, drawings and any other information provided by Canada to the Contractor, and shall be liable to Canada for any loss or damage from any causes.

**GC1.3 STATUS OF THE CONTRACTOR**

- 1) The Contractor is engaged under the Contract as an independent contractor.

- 2) The Contractor, its subcontractors and suppliers and any other person at any tier and their employees are not engaged by the Contract as employees, servants or agents of Canada.
- 3) For the purposes of the contract the Contractor shall be solely responsible for any and all payments and deductions required to be made by law including those required for Canada or Quebec Pension Plans, Employment Insurance, Worker's Compensation, provincial health or insurance plans, and Income Tax.

#### **GC1.4 RIGHTS AND REMEDIES**

- 1) Except as expressly provided in the Contract, the duties and obligations imposed by the Contract and the rights and remedies available thereunder shall be in addition to and not a limitation of any duties, obligations, rights, and remedies otherwise imposed or available by law.

#### **GC1.5 TIME OF THE ESSENCE**

- 1) Time is of the essence of the Contract.

#### **GC1.6 INDEMNIFICATION BY THE CONTRACTOR**

- 1) The Contractor shall pay all royalties and patent fees required for the performance of the Contract and, at the Contractor's expense, shall defend all claims, actions or proceedings against Canada charging or claiming that the Work or any part thereof provided or furnished by the Contractor to Canada infringes any patent, industrial design, copyright trademark, trade secret or other proprietary right enforceable in Canada.
- 2) The Contractor shall indemnify and save Canada harmless from and against all claims, demands, losses, costs, damages, actions, suits, or proceedings by any third party, brought or prosecuted and in any manner based upon, arising out of, related to, occasioned by, or attributable to the activities of the Contractor, its subcontractors and suppliers and any other person at any tier, in performing the Work.
- 3) For the purposes of paragraph 2) of GC1.6, "activities" means any act improperly carried out, any omission to carry out an act and any delay in carrying out an act.

#### **GC1.7 INDEMNIFICATION BY CANADA**

- 1) Subject to the [Crown Liability and Proceedings Act](#), the [Patent Act](#), and any other law that affects Canada's rights, powers, privileges or obligations, Canada shall indemnify and save the Contractor harmless from and against all claims, demands, losses, costs, damage, actions, suits or proceedings arising out of the Contractor's activities under the Contract that are directly attributable to
  - (a) a lack of or a defect in Canada's title to the Work site if owned by Canada, whether real or alleged; or
  - (b) an infringement or an alleged infringement by the Contractor of any patent of invention or any other kind of intellectual property occurring while the Contractor was performing any act for the purposes of the Contract employing a model, plan or design or any other thing related to the Work that was supplied by Canada to the Contractor.

**GC1.8 LAWS, PERMITS AND TAXES**

- 1) The Contractor shall comply with all federal, provincial and municipal laws and regulations applicable to the performance of the Work or any part thereof including, without limitation, all laws concerning health and labour conditions and the protection of the environment, and shall require compliance therewith by all of its subcontractors and suppliers at any tier as if the Work were being performed for an owner other than Canada. The Contractor shall furnish evidence of compliance with such laws and regulations to Canada at such times as Canada may reasonably request.
- 2) Unless stipulated otherwise in the Contract, the Contractor shall obtain and maintain all permits, certificates, licences, registrations and authorizations required for the lawful performance of the Work.
- 3) Prior to the commencement of the Work at the site, the Contractor shall tender to a municipal authority an amount equal to all fees and charges that would be lawfully payable to that municipal authority in respect of building permits as if the Work were being performed for an owner other than Canada.
- 4) Within 10 days of making a tender pursuant to paragraph 3) of GC1.8, the Contractor shall notify Canada of the amount properly tendered and whether or not the municipal authority has accepted that amount.
- 5) If the municipal authority has not accepted the amount tendered, the Contractor shall pay that amount to Canada within 6 days after the time stipulated in paragraph 4) of GC1.8.
- 6) For the purposes of this clause, "municipal authority" means any authority that would have jurisdiction respecting permission to perform the Work if the owner were not Canada.
- 7) Notwithstanding the residency of the Contractor, the Contractor shall pay any applicable tax arising from or related to the performance of the Work under the Contract.
- 8) In accordance with the Statutory Declaration referred to in paragraph 4) of GC5.5 SUBSTANTIAL PERFORMANCE OF THE WORK, a Contractor who has neither residence nor place of business in the province or territory in which work under the Contract is being performed shall provide Canada with proof of registration with the provincial sales tax authorities in the said province.
- 9) For the purpose of the payment of any Applicable Taxes or the furnishing of security for the payment of any Applicable Taxes arising from or related to the performance of the Work, and notwithstanding the provision that all Material, Plant and interest of the Contractor in all real property, licences, powers and privileges, become the property of Canada after the time of purchase in accordance with GC3.10 MATERIAL PLANT AND REAL PROPERTY BECOME PROPERTY OF CANADA, the Contractor shall be liable, as a user or consumer, for the payment or for the furnishing of security for the payment of any Applicable Taxes payable, at the time of the use or consumption of that Material, Plant or interest of the Contractor in accordance with the relevant legislation.
- 10) Federal government departments and agencies are required to pay Applicable Taxes.
- 11) Applicable Taxes will be paid by Canada as provided in the request for payment. It is the sole responsibility of the Contractor to charge Applicable Taxes at the correct rate in accordance with applicable legislation. The Contractor agrees to remit to appropriate tax authorities any amounts of Applicable Taxes paid or due.

- 12) The Contractor is not entitled to use Canada's exemptions from any tax, such as provincial sales taxes, unless otherwise specified by law. The Contractor must pay applicable provincial sales tax, ancillary taxes, and any commodity tax, on taxable goods or services used or consumed in the performance of the Contract (in accordance with applicable legislation), including for material incorporated into real property.
- 13) In those cases where Applicable Taxes, customs duties, and excise taxes are included in the Contract Amount, the Contract Amount will be adjusted to reflect any increase, or decrease, of Applicable Taxes, customs duties, and excise taxes that will have occurred between bid submission and contract award. However, there will be no adjustment for any change to increase the Contract Amount if public notice of the change was given before bid submission date in sufficient detail to have permitted the Contractor to calculate the effect of the change.
- 14) Tax Withholding of 15 Percent – Canada Revenue Agency  
  
Pursuant to the [Income Tax Act](#), 1985, c. 1 (5th Supp.) and the [Income Tax Regulations](#), Canada must withhold 15 percent of the amount to be paid to the Contractor in respect of services provided in Canada if the Contractor is not a resident of Canada, unless the Contractor obtains a valid waiver from the Canada Revenue Agency. The amount withheld will be held on account for the Contractor in respect to any tax liability which may be owed to Canada.

#### **GC1.9 WORKERS' COMPENSATION**

- 1) Prior to commencement of Work, at the time of Substantial Performance of the Work, and prior to issuance of the Certificate of Completion, the Contractor shall provide evidence of compliance with workers' compensation legislation applicable to the place of the Work, including payments due thereunder.
- 2) At any time during the term of the Contract, when requested by Canada, the Contractor shall provide such evidence of compliance by the Contractor, its subcontractors and any other person at any tier and any other person performing part of the Work who is required to comply with such legislation.

#### **GC1.10 NATIONAL SECURITY**

- 1) If Canada determines that the Work is of a class or kind that involves national security, Canada may order the Contractor to
  - (a) provide Canada with any information concerning persons employed or to be employed by the Contractor for purposes of the Contract; and
  - (b) remove any person from the site of the Work if, in the opinion of Canada, that person may be a risk to the national security;and the Contractor shall comply with the order.
- 2) In all contracts with persons who are to be employed in the performance of the Contract, the Contractor shall make provision for the performance of any obligation that may be imposed upon the Contractor under paragraph 1) of GC1.10.

**GC1.11 UNSUITABLE WORKERS**

- 1) Canada shall instruct the Contractor to remove from the site of the Work any person employed by the Contractor for purposes of the Contract who, in the opinion of Canada, is incompetent or is guilty of improper conduct, and the Contractor shall not permit a person who has been removed to return to the site of the Work.

**GC1.12 PUBLIC CEREMONIES AND SIGNS**

- 1) The Contractor shall not permit any public ceremony in connection with the Work without the prior consent of Canada.
- 2) The Contractor shall not erect nor permit the erection of any sign or advertising on the Work or its site without the prior consent of Canada.

**GC1.13 CONFLICT OF INTEREST**

- 1) It is a term of the Contract that no individual, for whom the post-employment provisions of the Conflict of Interest and Post-Employment Code for Public Office Holders or the Values and Ethics Code for the Public Service apply, shall derive a direct benefit from the Contract unless that individual is in compliance with the applicable post-employment provisions.

**GC1.14 AGREEMENTS AND AMENDMENTS**

- 1) The Contract constitutes the entire and sole agreement between the parties with respect to the subject matter of the Contract and supersedes all previous negotiations, communications and other agreements, whether written or oral, relating to it, unless they are incorporated by reference in the Contract. There are no terms, covenants, representations, statements or conditions binding on the parties other than those contained in the Contract.
- 2) The failure of either party at any time to require performance by the other party of any provision hereof shall not affect the right thereafter to enforce such provision. Nor shall the waiver by either party of any breach of any covenant, term or condition hereof be taken to be held to be a waiver of any further breach of the same covenant, term or condition.
- 3) The Contract may be amended only as provided for in the Contract.

**GC1.15 SUCCESSION**

- 1) The Contract shall inure to the benefit of and be binding upon the parties hereto and their lawful heirs, executors, administrators, successors and, subject to GC1.16 ASSIGNMENT, permitted assigns.

**GC1.16 ASSIGNMENT**

- 1) The Contractor shall not make any assignment of the Contract, either in whole or in part, without the written consent of Canada.

**GC1.17 NO BRIBE**

- 1) The Contractor represents and covenants that no bribe, gift, benefit, nor other inducement has been nor shall be paid, given, promised or offered directly or indirectly to any official or employee of Canada or to a member of the family of such a person, with a view to influencing the entry into the Contract or the administration of the Contract.

**GC1.18 CERTIFICATION - CONTINGENCY FEES**

- 1) In this clause
  - (a) "contingency fee" means any payment or other compensation that is contingent upon or is calculated upon the basis of a degree of success in soliciting or obtaining a Government contract or negotiating the whole or any part of its terms;
  - (b) "employee" means a person with whom the Contractor has an employer/employee relationship; and
  - (c) "person" includes an individual or a group of individuals, a corporation, a partnership, an organization and an association and, without restricting the generality of the foregoing, includes any individual who is required to file a return with the registrar pursuant to section 5 of the [Lobbying Act](#) R.S.C. 1985 c.44 (4th Supplement) as the same may be amended from time to time.
- 2) The Contractor certifies that it has not directly or indirectly paid nor agreed to pay and covenants that it shall not directly or indirectly pay nor agree to pay a contingency fee for the solicitation, negotiation or obtaining of the Contract to any person other than an employee acting in the normal course of the employee's duties.
- 3) All accounts and records pertaining to payments of fees or other compensation for the solicitation, obtaining or negotiation of the Contract shall be subject to the accounts and audit provisions of the Contract.
- 4) If the Contractor certifies falsely under this section or is in default of the obligations contained therein, Canada may either take the Work out of the Contractor's hands in accordance with the provisions of the Contract or recover from the Contractor by way of reduction to the Contract Amount or otherwise, the full amount of the contingency fee.

**GC1.19 INTERNATIONAL SANCTIONS**

- 1) Persons and companies in Canada, and Canadians outside of Canada are bound by economic sanctions imposed by Canada. As a result, the Government of Canada cannot accept delivery of goods or services that originate, either directly or indirectly, from the countries or persons subject to [economic sanctions](#)
- 2) It is a condition of the Contract that the Contractor not supply to the Government of Canada any goods or services which are subject to economic sanctions.
- 3) By law, the Contractor must comply with changes to the regulations imposed during the life of the Contract. During the performance of the Contract should the imposition of sanctions against a country or person or the addition of a good or service to the list of sanctioned goods or services cause an impossibility of performance for the Contractor, the Contractor may request that the Contract be terminated in accordance with GC7.3 TERMINATION OF CONTRACT.

**GC2 ADMINISTRATION OF THE CONTRACT**

- GC2.1 DEPARTMENTAL REPRESENTATIVE'S AUTHORITY
- GC2.2 INTERPRETATION OF CONTRACT
- GC2.3 NOTICES
- GC2.4 SITE MEETINGS
- GC2.5 REVIEW AND INSPECTION OF WORK
- GC2.6 SUPERINTENDENT
- GC2.7 NON-DISCRIMINATION IN HIRING AND EMPLOYMENT OF LABOUR
- GC2.8 ACCOUNTS AND AUDITS

**GC2.1 DEPARTMENTAL REPRESENTATIVE'S AUTHORITY**

- 1) Canada shall designate a Departmental Representative and shall notify the Contractor of the name, address and telephone number of the Departmental Representative.
- 2) The Departmental Representative shall perform Canada's duties and functions under the contract.
- 3) The Departmental Representative shall be authorized to issue notices, instructions and directions to the Contractor and to accept on behalf of Canada any notice, order or other communication from the contractor relating to the Work.
- 4) The Departmental Representative shall, within a reasonable time, review and respond to submissions made by the Contractor in accordance with the requirements of the Contract.

**GC2.2 INTERPRETATION OF CONTRACT**

- 1) If, at any time before Canada has issued a Certificate of Completion, any question arises between the parties about whether anything has been done as required by the Contract or about what the Contractor is required by the Contract to do, and in particular but without limiting the generality of the foregoing, about
  - (a) the meaning of anything in the drawings and specifications;
  - (b) the meaning to be given to the drawings and specifications in case of any error therein, omission therefrom, or obscurity or discrepancy in their wording or intention;
  - (c) whether or not the quality or quantity of any Material or workmanship supplied or proposed to be supplied by the Contractor meets the requirements of the Contract;
  - (d) whether or not the labour, Plant or Material performed, used and supplied by the Contractor for performing the Work and carrying out the Contract are adequate to ensure that the Work shall be performed in accordance with the Contract and that the Contract shall be carried out in accordance with its terms;
  - (e) what quantity of any of the Work has been completed by the Contractor; or
  - (f) the timing and scheduling of the various phases of the performance of the Work as specified in the Contract;

the question shall be decided, subject to the provisions of GC8 DISPUTE RESOLUTION, by Canada.



- 2) The Contractor shall perform the Work in accordance with any decisions of Canada that are made under paragraph 1) of GC2.2 and in accordance with any consequential directions given by Canada.
- 3) If the Contractor fails to comply with any instruction or direction issued by Canada pursuant to the Contract, Canada may employ such methods as Canada deems advisable to do what the Contractor failed to do, and the Contractor shall, on demand, pay Canada an amount that is equal to the aggregate of all costs, expenses and damages incurred or sustained by Canada by reason of the Contractor's failure to comply with such instruction or direction, including the cost of any methods employed by Canada in doing what the Contractor failed to do.

**GC2.3 NOTICES**

- 1) Subject to paragraph 3) of GC2.3, any notice, order or other communication may be given in any manner, and if required to be in writing, shall be addressed to the party to whom it is intended at the address in the Contract or at the last address of which the sender has received written notice in accordance with this section.
- 2) Any notice, order or other communication given in writing in accordance with paragraph 1) of GC2.3 shall be deemed to have been received by either party
  - (a) if delivered personally, on the day that it was delivered;
  - (b) if forwarded by mail, on the earlier of the day it was received or the sixth day after it was mailed; and
  - (c) if forwarded by facsimile or electronic mail, 24 hours after it was transmitted.
- 3) A notice given under GC7.1 TAKING THE WORK OUT OF THE CONTRACTOR'S HANDS, GC7.2 SUSPENSION OF WORK, and GC7.3 TERMINATION OF CONTRACT shall be given in writing and, if delivered personally, shall be delivered, if the Contractor is a sole proprietor, to the Contractor or, if the Contractor is a partnership or corporation, to an officer thereof.

**GC2.4 SITE MEETINGS**

- 1) In consultation with Canada, the Contractor shall arrange site meetings at regular intervals, with all involved parties who are to attend, in order to ensure, among other things, the proper co-ordination of the Work.

**GC2.5 REVIEW AND INSPECTION OF WORK**

- 1) Canada shall review the Work to determine if it is proceeding in conformity with the Contract and to record the necessary data to make an assessment of the value of Work completed. Canada shall measure and record the quantities of labour, Plant and Material performed, used or supplied by the Contractor in performing the Work or any part thereof that is subject to a Unit Price Arrangement and, on request, shall inform the Contractor of those measurements, and permit the Contractor to inspect any records pertaining thereto.
- 2) Canada shall reject Work or Material which in Canada's opinion does not conform to the requirements of the Contract, and shall require inspection or testing of Work, whether or not such Work is fabricated, installed, or completed. If such Work is not in accordance with the

requirements of the Contract, the Contractor shall correct the Work and shall pay Canada, on demand, all reasonable costs and expenses that were incurred by Canada in having the examination performed.

- 3) The Contractor shall provide Canada with access to the Work and its site at all times, and at all times shall provide sufficient, safe, and proper facilities for the review and inspection of the Work by persons authorized by Canada and any representatives of those authorities having jurisdiction. If parts of the Work are in preparation at locations other than the site of the Work, Canada shall be given access to such Work whenever it is in progress.
- 4) The Contractor shall furnish Canada with such information respecting the performance of the Contract as Canada may require, and render every possible assistance to enable Canada to verify that the Work is performed in accordance with the Contract, carry out any other duties and exercise any powers in accordance with the Contract.
- 5) If Work is designated for tests, inspections, or approvals in the Contract or by Canada's instructions, or by laws or ordinances of the place of the Work, the Contractor shall give Canada reasonable notice of when such Work shall be ready for review and inspection. The Contractor shall arrange for and shall give Canada reasonable notice of the date and time of inspections, tests or approvals.
- 6) If the Contractor covers, or permits to be covered, Work that has been designated for tests, inspections or approvals before such tests, inspections or approvals are made, completed or given, the Contractor shall, if so directed by Canada, uncover such Work, have the inspections, tests or approvals satisfactorily made, completed or given and make good the covering of the Work at the Contractor's expense.

**GC2.6 SUPERINTENDENT**

- 1) Prior to commencing the Work, the Contractor shall designate a Superintendent and shall notify Canada of the name, address and telephone number of the Superintendent. The Contractor shall keep the Superintendent at the Work site during working hours until the Work has reached completion.
- 2) The Superintendent shall be in full charge of the operations of the Contractor during the performance of the Work and shall be authorized to accept on behalf of the Contractor any notice, order or other communication given to the Superintendent or the Contractor relating to the Work.
- 3) Upon request of Canada, the Contractor shall remove any Superintendent who, in the opinion of Canada, is incompetent or has been guilty of improper conduct, and shall forthwith designate another Superintendent who is acceptable to Canada.
- 4) The Contractor shall not substitute a Superintendent without the written consent of Canada. If a Superintendent is substituted without such consent, Canada shall be entitled to refuse to issue any documentation or certification relating to progress payments, Substantial Performance or Completion of the Work until the Superintendent has returned to the Work site or another Superintendent who is acceptable to Canada has been substituted.

**GC2.7 NON-DISCRIMINATION IN HIRING AND EMPLOYMENT OF LABOUR**

- 1) For the purposes of this clause, "persons" include the Contractor, its subcontractors and suppliers at any tier and their respective employees, agents, licensees or invitees and any other individual involved in the performance of the Work or granted access to the Work site.

A “person” includes any partnership, proprietorship, firm, joint venture, consortium and corporation.

- 2) Without restricting the provisions of paragraph 3) of GC2.6, SUPERINTENDENT, the Contractor shall not refuse to employ and shall not discriminate in any manner against any person because
  - (a) of that person's race, national or ethnic origin, colour, religion, age, sex, sexual orientation, marital status, disability, conviction for which a pardon has been granted, or family status;
  - (b) of the race, national or ethnic origin, colour, religion, age, sex, sexual orientation, marital status, disability, conviction for which a pardon has been granted, or family status of any person having a relationship or association with that person, or
  - (c) a complaint has been made or information has been given in respect of that person relating to an alleged failure by the Contractor to comply with subparagraph (a) or (b).
- 3) Within two working days immediately following receipt of a written complaint pursuant to paragraph 2) of GC2.7, the Contractor shall
  - (a) cause to have issued a written direction to the person or persons named by the complainant to cease all actions that form the basis of the complaint;
  - (b) forward a copy of the complaint to Canada by registered mail or courier service; and
  - (c) when the Labour Conditions are applicable under the circumstances of the complaint, forward a copy of the complaint to HRSDC - Labour to the attention of the appropriate Director as described in the Labour Conditions (“HRSDC - Labour” means the labour component of the federal Department of Human Resources and Social Development).
- 4) Within twenty four (24) hours immediately following receipt of a direction from Canada to do so, the Contractor shall cause to have removed from the site of the Work and from the performance of Work under the Contract, any person or persons whom Canada believes to be in breach of the provisions of paragraph 2) of GC2.7.
- 5) No later than thirty (30) days after receipt of the direction referred to in paragraph 4) of GC2.7, the Contractor shall cause the necessary action to be commenced to remedy the breach described in the direction.
- 6) If a direction is issued pursuant to paragraph 4) of GC2.7, Canada may withhold from monies that are due and payable to the Contractor or setoff pursuant to GC5.9 RIGHT OF SETOFF, whichever is applicable, an amount representing the sum of the costs and payment referred to in paragraph 8) of GC2.7.
- 7) If the Contractor fails to proceed in accordance with paragraph 5) of GC2.7, Canada shall take the necessary action to have the breach remedied, and shall determine all supplementary costs incurred by Canada as a result.
- 8) Canada may make a payment directly to the complainant from monies that are due and payable to the Contractor upon receipt from the complainant of
  - (a) a written award issued pursuant to the federal [Commercial Arbitration Act](#), R.S.C. 1985, c. 17 (2nd Supp.);

- (b) a written award issued pursuant to the Canadian Human Rights Act, R.S.C. 1985, c. H-6;
  - (c) a written award issued pursuant to provincial or territorial human rights legislation; or
  - (d) a judgement issued by a court of competent jurisdiction.
- 9) If Canada is of the opinion that the Contractor has breached any of the provisions of this clause, Canada may take the Work out of the Contractor's hands pursuant to GC7.1 TAKING THE WORK OUT OF THE CONTRACTOR'S HANDS.
- 10) Subject to paragraph 7) of GC3.6 SUBCONTRACTING, the Contractor shall ensure that the provisions of this clause are included in all agreements and contracts entered into as a consequence of the Work.

### GC2.8 ACCOUNTS AND AUDITS

- 1) The Contractor shall, in addition to the requirements expressed in paragraph 6) of GC3.4 EXECUTION OF THE WORK, maintain full records of the Contractor's estimated and actual cost of the Work together with all tender calls, quotations, contracts, correspondence, invoices, receipts and vouchers relating thereto, and shall make them available on request to audit and inspection by Canada and the Deputy Receiver General for Canada or by persons designated to act on behalf of either or both of them.
- 2) The Contractor shall allow any of the persons referred to in paragraph 1) of GC2.8 to make copies of and take extracts from any of the records and material, and shall furnish such persons or entities with any information those persons or entities may require from time to time in connection with such records and material.
- 3) The Contractor shall maintain and keep the records intact until the expiration of two years after the date that a Certificate of Completion has been issued or until the expiration of such other period of time as Canada may direct.
- 4) The Contractor shall cause all subcontractors at any tier and all other persons directly or indirectly controlled by or affiliated with the Contractor and all persons directly or indirectly having control of the Contractor to comply with the requirements of this clause as if they were the Contractor.

**GC3 EXECUTION AND CONTROL OF THE WORK**

- GC3.1 PROGRESS SCHEDULE
- GC3.2 ERRORS AND OMISSIONS
- GC3.3 CONSTRUCTION SAFETY
- GC3.4 EXECUTION OF THE WORK
- GC3.5 MATERIAL
- GC3.6 SUBCONTRACTING
- GC3.7 CONSTRUCTION BY OTHER CONTRACTORS OR WORKERS
- GC3.8 LABOUR
- GC3.9 TRUCK HAULAGE RATES (CANCELLED)
- GC3.10 MATERIAL, PLANT AND REAL PROPERTY BECOME PROPERTY OF CANADA
- GC3.11 DEFECTIVE WORK
- GC3.12 CLEANUP OF SITE
- GC3.13 WARRANTY AND RECTIFICATION OF DEFECTS IN WORK

**GC3.1 PROGRESS SCHEDULE**

- 1) The Contractor shall
  - (a) prepare and submit to Canada, prior to the submission of the Contractor's first progress claim, a progress schedule in accordance with the requirements set out in the Contract;
  - (b) monitor the progress of the Work relative to the schedule and update the schedule as stipulated by the contract documents;
  - (c) advise Canada of any revisions to the schedule required as the result of any extension of time for completion of the Contract that was approved by Canada; and
  - (d) prepare and submit to Canada, at the time of issuance of a Certificate of Substantial Performance, an update of any schedule clearly showing a detailed timetable that is acceptable to Canada for the completion of any unfinished Work and the correction of all listed defects.

**GC3.2 ERRORS AND OMISSIONS**

- 1) The Contractor shall report promptly to Canada any errors, discrepancies, or omissions the Contractor may discover when reviewing the contract documents. In making a review, the Contractor does not assume any responsibility to Canada for the accuracy of the review. The Contractor shall not be liable for damage or costs resulting from such errors, discrepancies, or omissions in the contract documents prepared by or on behalf of Canada that the Contractor did not discover.

**GC3.3 CONSTRUCTION SAFETY**

- 1) Subject to GC3.7 CONSTRUCTION BY OTHER CONTRACTORS OR WORKERS, the Contractor shall be solely responsible for construction safety at the place of the Work and for initiating, maintaining and supervising all safety precautions and programs in connection with the performance of the Work. In any emergency, the Contractor shall either stop the Work, make changes or order extra work to ensure the safety of life and the protection of the Work and neighbouring property.

- 2) Prior to commencing the Work, the Contractor shall notify the authorities having jurisdiction for construction safety at the site of the Work with respect to the intended commencement of the Work, and shall provide such authority with whatever additional information may be required by that authority.

**GC3.4 EXECUTION OF THE WORK**

- 1) The Contractor shall perform, use or supply and pay for, all labour, Plant, Material, tools, construction machinery and equipment, water, heat, light, power, transportation and other facilities and services necessary for the performance of the Work in accordance with the Contract.
- 2) The Contractor shall, at all times, perform the Work in a proper, diligent and expeditious manner as is consistent with construction industry standards and in accordance with the progress schedule prepared pursuant to GC3.1 PROGRESS SCHEDULE and shall provide sufficient personnel to fulfil the Contractor's obligations in accordance with that schedule.
- 3) Subject to paragraph 4) of GC3.4, the Contractor shall have complete care, custody and control of the Work and shall direct and supervise the Work so as to ensure compliance with the Contract. The Contractor shall be responsible for construction means, methods, techniques, sequences and procedures and for co-ordinating the various parts of the Work.
- 4) When requested in writing by Canada, the Contractor shall make appropriate alterations in the method, Plant or workforce at any time Canada considers the Contractor's actions to be unsafe or damaging to either the Work, existing facilities, persons at the site of the Work or the environment.
- 5) The Contractor shall have sole responsibility for the design, erection, operation, maintenance and removal of temporary structures and other temporary facilities and for the construction methods used in their erection, operation, maintenance and removal. The Contractor shall engage and pay for registered professional engineering personnel, skilled in the appropriate discipline to perform these functions if required by law or by the Contract, and in all cases when such temporary facilities and their methods of construction are of such a nature that professional engineering skill is required to produce safe and satisfactory results.
- 6) The Contractor shall keep at least one copy of current contract documents, submittals, reports, and records of meetings at the site of the Work, in good order and available to Canada.
- 7) Except for any part of the Work that is necessarily performed away from or off the site of the Work, the Contractor shall confine Plant, storage of Material, and operations of employees to limits indicated by laws, ordinances, permits or the contract documents.

**GC3.5 MATERIAL**

- 1) Unless otherwise specified in the Contract, all Material incorporated in the Work shall be new.
- 2) Subject to paragraph 3) of GC3.5, if a specified reused, refurbished, or recycled item of Material is not available, the Contractor shall apply to Canada to substitute a similar item for the one specified.
- 3) If Canada agrees that the Contractor's application for substitution of a reused, refurbished or recycled item is warranted, and that the substitute item is of acceptable quality and value to

that specified and is suitable for the intended purpose, Canada may approve the substitution, subject to the following:

- (a) the request for substitution shall be made in writing to Canada and shall be substantiated by information in the form of the manufacturer's literature, samples and other data that may be required by Canada;
- (b) the Contractor shall make the request for substitution in a manner that shall not negatively affect the progress schedule of the Contract and well in advance of the time the item of Material must be ordered;
- (c) substitution of Material shall be permitted only with the prior written approval of Canada, and any substituted items that are supplied or installed without such approval shall be removed from the site of the Work at the expense of the Contractor, and specified items installed at no additional cost to Canada; and
- (d) the Contractor shall be responsible for all additional expenses incurred by Canada, the Contractor, its subcontractors and suppliers at any tier due to the Contractor's use of the substitute.

### **GC3.6 SUBCONTRACTING**

- 1) Subject to the provisions of this clause, the Contractor may subcontract any part of the Work but not the whole of the Work.
- 2) The Contractor shall notify Canada in writing of the Contractor's intention to subcontract.
- 3) A notification referred to in paragraph 2) of GC3.6 shall identify the part of the Work and the Subcontractor with whom the Contractor intends to subcontract.
- 4) Canada may for reasonable cause, object to the intended subcontracting by notifying the Contractor in writing within six (6) days of receipt by Canada of a notification referred to in paragraph 2) of GC3.6.
- 5) If Canada objects to a subcontracting, the Contractor shall not enter into the intended subcontract.
- 6) The Contractor shall not change, nor permit to be changed, a Subcontractor engaged by the Contractor, in accordance with this clause, without the written consent of Canada.
- 7) The Contractor shall ensure that all the terms and conditions of the Contract that are of general application shall be incorporated in every other contract issued as a consequence of the Contract, at whatever tier, except those contracts issued solely to suppliers at any tier for the supply of Plant or Material.
- 8) Neither a subcontracting nor Canada's consent to a subcontracting shall be construed to relieve the Contractor from any obligation under the Contract or to impose any liability upon Canada.

### **GC3.7 CONSTRUCTION BY OTHER CONTRACTORS OR WORKERS**

- 1) Canada reserves the right to send other contractors or workers, with or without Plant and Material, onto the site of the Work.

- 2) When other contractors or workers are sent on to the site of the Work, Canada shall
  - (a) enter into separate contracts, to the extent it is possible, with the other contractors under conditions of contract that are compatible with the conditions of the Contract;
  - (b) ensure that the insurance coverage provided by the other contractors is co-ordinated with the insurance coverage of the Contractor as it affects the Work; and
  - (c) take all reasonable precautions to avoid labour disputes or other disputes arising from the work of the other contractors or workers.
- 3) When other contractors or workers are sent on to the site of the Work, the Contractor shall
  - (a) co-operate with them in the carrying out of their duties and obligations;
  - (b) co-ordinate and schedule the Work with the work of the other contractors and workers;
  - (c) participate with other contractors and workers in reviewing their construction schedules when directed to do so;
  - (d) where part of the Work is affected by or depends upon the work of other contractors or workers for its proper execution, promptly report to Canada in writing and prior to proceeding with that part of the Work, any apparent deficiencies in such work. Failure by the Contractor to so report shall invalidate any claims against Canada by reason of the deficiencies in the work of other contractors or workers except those deficiencies that are not then reasonably discoverable; and
  - (e) when designated as being responsible for construction safety at the place of work in accordance with the applicable provincial or territorial laws, carry out its duties in that role and in accordance with those laws.
- 4) If, when entering into the Contract, the Contractor could not have reasonably foreseen nor anticipated the sending of other contractors or workers on to the site of the Work and provided the Contractor
  - (a) incurs extra expense in complying with the requirements of paragraph 3) of GC3.7; and
  - (b) gives Canada written notice of a claim for that extra expense within thirty (30) days of the date that the other contractors or workers were sent onto the Work or its site;

Canada shall pay the Contractor the cost of the extra labour, Plant and Material that was necessarily incurred, calculated in accordance with GC6.4 DETERMINATION OF PRICE.

### **GC3.8 LABOUR**

- 1) To the extent to which they are available, consistent with proper economy and the expeditious carrying out of the Work, the Contractor shall, in the performance of the Work, employ a reasonable number of persons who have been on active service with the Armed Forces of Canada and have been honourably discharged therefrom.



- 2) The Contractor shall maintain good order and discipline among the Contractor's employees and workers engaged in the Work and shall not employ on the site of the Work anyone not skilled in the tasks assigned.

**GC3.9 TRUCK HAULAGE RATES**

CANCELLED

**GC3.10 MATERIAL, PLANT AND REAL PROPERTY BECOME PROPERTY OF CANADA**

- 1) Subject to paragraph 9) of GC1.8 LAWS PERMITS AND TAXES, all Material and Plant and the interest of the Contractor in all real property, licences, powers and privileges purchased, used or consumed by the Contractor for the Work shall, immediately after the time of their purchase, use or consumption be the property of Canada for the purposes of the Work and they shall continue to be the property of Canada
  - (a) in the case of Material, until Canada indicates that the Materials shall not be required for the Work; and
  - (b) in the case of Plant, real property, licences, powers and privileges, until Canada indicates that the interest vested in Canada therein is no longer required for the purposes of the Work.
- 2) Material or Plant, that is the property of Canada by virtue of paragraph 1) of GC3.10, shall not be taken away from the site of the Work nor used nor disposed of except for the purposes of the Work without the written consent of Canada.
- 3) Canada is not liable for loss of nor damage from any cause to the Material or Plant referred to in paragraph 1) of GC3.10, and the Contractor is liable for such loss or damage notwithstanding that the Material or Plant is the property of Canada.

**GC3.11 DEFECTIVE WORK**

- 1) The Contractor shall promptly remove from the site of the Work and replace or re-execute defective Work whether or not the defective Work has been incorporated in the Work and whether or not the defect is the result of poor workmanship, use of defective Material, or damage through carelessness or other act or omission of the Contractor.
- 2) The Contractor, at the Contractor's expense, shall promptly make good other work destroyed or damaged by such removals or replacements.
- 3) If, in the opinion of Canada, it is not expedient to correct defective Work or Work not performed as provided for in the Contract documents, Canada may deduct from the amount otherwise due to the Contractor the difference in value between the Work as performed and that called for by the contract documents.
- 4) The failure of Canada to reject any defective Work or Material shall not constitute acceptance of the defective Work or Material.

**GC3.12 CLEANUP OF SITE**

- 1) The Contractor shall maintain the Work and its site in a tidy condition and free from an accumulation of waste material and debris.
- 2) Before the issue of a Certificate of Substantial Performance, the Contractor shall remove waste material and debris, and all Plant and Material not required for the performance of the remaining Work and, unless otherwise stipulated in the Contract Documents, shall cause the Work and its site to be clean and suitable for occupancy by Canada.
- 3) Before the issue of a Certificate of Completion, the Contractor shall remove all surplus Plant and Materials and any waste products and debris from the site of the Work.
- 4) The Contractor's obligations described in paragraphs 1) to 3) of GC3.12 do not extend to waste products and other debris caused by Canada's servants, or by other contractors and workers referred to in GC3.7 CONSTRUCTION BY OTHER CONTRACTORS OR WORKERS.

**GC3.13 WARRANTY AND RECTIFICATION OF DEFECTS IN WORK**

- 1) Without restricting any warranty or guarantee implied or imposed by law or contained in the Contract, the Contractor shall, at the Contractor's expense
  - (a) rectify and make good any defect or fault that appears in the Work or comes to the attention of Canada with respect to those parts of the Work accepted in connection with the Certificate of Substantial Performance within 12 months from the date of Substantial Performance; and
  - (b) rectify and make good any defect or fault that appears in or comes to the attention of Canada in connection with those parts of the Work described in the Certificate of Substantial Performance within 12 months from the date of the Certificate of Completion.
  - (c) transfer and assign, to Canada, any subcontractor, manufacturer or supplier extended warranties or guarantees implied or imposed by law or contained in the Contract covering periods beyond the 12 months stipulated above. Extended warranties or guarantees referred to herein shall not extend the 12-month period whereby the Contractor, except as may be provided elsewhere in the Contract, must rectify and make good any defect or fault that appears in the Work or comes to the attention of Canada.
  - (d) provide, to Canada prior to the issuance of the Certificate of Completion, a list of all extended warranties and guarantees referred to in paragraph (c) above.
- 2) Canada may direct the Contractor to rectify and make good any defect or fault referred to in paragraph 1) of GC3.13 or covered by any other expressed or implied warranty or guarantee and the Contractor shall rectify and make good such defect within the time stipulated in the direction.
- 3) A direction referred to in paragraph 2) GC3.13 shall be in writing and shall be given to the Contractor in accordance with GC2.3 NOTICES.

**GC4 PROTECTIVE MEASURES**

GC4.1 PROTECTION OF WORK AND PROPERTY

GC4.2 PRECAUTIONS AGAINST DAMAGE, INFRINGEMENT OF RIGHTS, FIRE AND OTHER HAZARDS

GC4.3 MATERIAL, PLANT AND REAL PROPERTY SUPPLIED BY CANADA

GC4.4 CONTAMINATED SITE CONDITIONS

**GC4.1 PROTECTION OF WORK AND PROPERTY**

- 1) The Contractor shall protect the Work and its site against loss or damage from any cause and shall similarly protect all Material, Plant and real property under the Contractor's care, custody and control whether or not such Material, Plant and real property are supplied by Canada to the Contractor.
- 2) The Contractor shall provide all facilities necessary for the purpose of maintaining security, and shall assist any person authorized by Canada to inspect or to take security measures in respect of the Work and its site.
- 3) Canada may direct the Contractor to do such things and to perform such work as Canada considers reasonable and necessary to ensure compliance with or to remedy a breach of paragraphs 1) or 2) of GC4.1, and the Contractor, shall comply with such direction.

**GC4.2 PRECAUTIONS AGAINST DAMAGE, INFRINGEMENT OF RIGHTS, FIRE AND OTHER HAZARDS**

- 1) The Contractor shall do whatever is necessary to ensure that
  - (a) no person, property, right, easement nor privilege is injured, damaged or infringed upon by reasons of the Contractor's activities in performing the Work;
  - (b) pedestrian and other traffic on any public or private road or waterway is not unduly impeded, interrupted nor endangered by the performance or existence of the Work, Material or Plant;
  - (c) fire hazards in or about the site of the Work are eliminated and any fire is promptly extinguished;
  - (d) the health and safety of all persons employed in the performance of the Work is not endangered by the methods nor means of their performance;
  - (e) adequate medical services are available to all persons employed on the Work or its site at all times during the performance of the Work;
  - (f) adequate sanitation measures are taken in respect of the Work and its site; and
  - (g) all stakes, buoys and marks placed on the Work or its site by Canada are protected and are not removed, defaced, altered nor destroyed.
- 2) Canada may direct the Contractor to do such things and to perform such work as Canada considers reasonable and necessary to ensure compliance with or to remedy a breach of paragraph 1) of GC4.2, and the Contractor shall comply with the direction of Canada.

**GC4.3 MATERIAL, PLANT AND REAL PROPERTY SUPPLIED BY CANADA**

- 1) Subject to paragraph 2) of GC4.3, the Contractor is liable to Canada for any loss of or damage to Material, Plant or real property that is supplied or placed in the care, custody and control of the Contractor by Canada for use in connection with the Contract, whether or not that loss or damage is attributable to causes beyond the Contractor's control.
- 2) The Contractor is not liable to Canada for any loss or damage to Material, Plant or real property referred to in paragraph 1) of GC4.3 if that loss or damage results from and is directly attributable to reasonable wear and tear.
- 3) The Contractor shall not use any Material, Plant or real property supplied by Canada except for the purpose of performing the Contract.
- 4) When the Contractor fails to make good any loss or damage for which the Contractor is liable under paragraph 1) within a reasonable time, Canada may cause the loss or damage to be made good at the Contractor's expense, and the Contractor shall thereupon be liable to Canada for the cost thereof and shall, on demand, pay to Canada an amount equal to that cost.
- 5) The Contractor shall keep records of all Material, Plant and real property supplied by Canada as Canada requires and shall satisfy Canada, when requested, that such Material, Plant and real property are at the place and in the condition in which they ought to be.

**GC4.4 CONTAMINATED SITE CONDITIONS**

- 1) For the purposes of GC4.4, a contaminated site condition exists when a solid, liquid, gaseous, thermal or radioactive irritant or contaminant, or other hazardous or toxic substance or material, including moulds and other forms of fungi, is present at the site of the Work to an extent that constitutes a hazard, or potential hazard, to the environment, property, or the health or safety of any person.
- 2) If the Contractor encounters a contaminated site condition of which the Contractor is not aware or about which the Contractor has not been advised, or if the Contractor has reasonable grounds to believe that such a site condition exists at the site of the Work, the Contractor shall
  - (a) take all reasonable steps, including stopping the Work, to ensure that no person suffers injury, sickness or death, and that neither property nor the environment is injured or destroyed as a result of the contaminated site condition;
  - (b) immediately notify Canada of the circumstances in writing; and
  - (c) take all reasonable steps to minimize additional costs that may accrue as a result of any work stoppage.
- 3) Upon receipt of a notification from the Contractor, Canada shall promptly determine whether a contaminated site condition exists, and shall notify the Contractor in writing of any action to be taken, or work to be performed, by the Contractor as a result of Canada's determination.
- 4) If the Contractor's services are required by Canada, the Contractor shall follow the direction of Canada with regard to any excavation, treatment, removal and disposal of any polluting substance or material.

- 5) Canada, at Canada's sole discretion, may enlist the services of experts and specialty contractors to assist in determining the existence of, and the extent and treatment of contaminated site conditions, and the Contractor shall allow them access and co-operate with them in the carrying out of their duties and obligations.
- 6) Except as may be otherwise provided for in the Contract, the provisions of GC6.4 DETERMINATION OF PRICE shall apply to any additional work made necessary because of a contaminated site condition.

**GC5 TERMS OF PAYMENT**

- GC5.1 INTERPRETATION
- GC5.2 AMOUNT PAYABLE
- GC5.3 INCREASED OR DECREASED COSTS
- GC5.4 PROGRESS PAYMENT
- GC5.5 SUBSTANTIAL PERFORMANCE OF THE WORK
- GC5.6 FINAL COMPLETION
- GC5.7 PAYMENT NOT BINDING ON CANADA
- GC5.8 CLAIMS AND OBLIGATIONS
- GC5.9 RIGHT OF SETOFF
- GC5.10 ASSESSMENTS AND DAMAGES FOR LATE COMPLETION
- GC5.11 DELAY IN MAKING PAYMENT
- GC5.12 INTEREST ON SETTLED CLAIMS
- GC5.13 RETURN OF SECURITY DEPOSIT

**GC5.1 INTERPRETATION**

In these Terms of Payment

- 1) The "payment period" means a period of 30 consecutive days or such other longer period as may be agreed between the Contractor and Canada.
- 2) An amount is "due and payable" when it is due and payable by Canada to the Contractor according to GC5.4 PROGRESS PAYMENT, GC5.5 SUBSTANTIAL PERFORMANCE OF THE WORK or GC5.6 FINAL COMPLETION.
- 3) An amount is "overdue" when it remains unpaid on the first day following the day upon which it is due and payable.
- 4) The "date of payment" means the date of the negotiable instrument of an amount due and payable by the Receiver General for Canada.
- 5) The "Bank Rate" means the rate of interest established by the Bank of Canada as the minimum rate at which it makes short term advances to members of the Canadian Payments Association.
- 6) The "Average Bank Rate" means the simple arithmetic mean of the Bank Rate in effect at 4:00 p.m. Eastern Time each day during the calendar month which immediately precedes the calendar month in which payment is made.

**GC5.2 AMOUNT PAYABLE**

- 1) Subject to any other provisions of the Contract, Canada shall pay the Contractor, at the times and in the manner hereinafter set out, the amount by which the amounts payable by Canada to the Contractor in accordance with the Contract exceed the amounts payable by the Contractor to Canada, and the Contractor shall accept that amount as payment in full satisfaction for everything furnished and done by the Contractor in respect of the Work to which the payment relates.
- 2) When making any payment to the Contractor, the failure of Canada to deduct an amount payable to Canada by the Contractor shall not constitute a waiver of the right to do so, or an admission of lack of entitlement to do so in any subsequent payment to the Contractor.

- 3) Should any payment be made by Canada in excess of what is owed to the Contractor for the actual work performed, the Contractor will reimburse Canada the excess immediately, with or without demand, and any amounts outstanding shall bear simple interest at the Average Bank rate plus 3 percent per annum from the date of overpayment until the day prior to the date of repayment by the Contractor.
- 4) No payment other than a payment that is expressly stipulated in the Contract shall be made by Canada to the Contractor for any extra expense or any loss or damage incurred or sustained by the Contractor.

### **GC5.3 INCREASED OR DECREASED COSTS**

- 1) The Contract Amount shall not be increased nor decreased by reason of any increase or decrease in the cost of the Work that is brought about by an increase or decrease in the cost of labour, Plant, Material or any wage adjustment arising pursuant to the Labour Conditions.
- 2) Notwithstanding paragraph 1) of GC5.3, if any change, including a new imposition or repeal, of any tax, customs or other duty, charge, or any similar imposition that is imposed under sales, customs or excise tax legislation of the Government of Canada or any Provincial or Territorial legislation, affects the cost of the Work to the Contractor, and occurs
  - (a) after the date of submission by the Contractor of its bid; or
  - (b) after the date of submission of the last revision, if the Contractor's bid was revised;the Contract Amount shall be adjusted in the manner provided in paragraph 3) of GC5.3.
- 3) If a change referred to in paragraph 2) of GC5.3 occurs, the Contract Amount shall be increased or decreased by an amount established by an examination by Canada of the relevant records of the Contractor referred to in GC2.8 ACCOUNTS AND AUDITS to be the increase or decrease in the cost incurred by the Contractor that is directly attributable to that change.
- 4) For the purpose of paragraph 2) of GC5.3, if a tax is changed after the solicitation closing, but public notice of the change has been given by the Minister of Finance or the corresponding Provincial or Territorial authority before that closing, the change shall be deemed to have occurred before the solicitation closing.
- 5) Notwithstanding paragraphs 2) to 4) of GC5.3, no adjustment to the Contract Amount in respect of the Work or a part thereof shall be made for a change in any imposition referred to in this section that occurs after the date required by the Contract for completion of the Work or that part of the Work.

### **GC5.4 PROGRESS PAYMENT**

- 1) On the expiration of a payment period, the Contractor shall deliver to Canada
  - (a) a written progress claim in a form acceptable to Canada that fully describes any part of the Work that has been completed, and any Material that was delivered to the Work site but not incorporated into the Work, during that payment period, and
  - (b) a completed and signed statutory declaration containing a declaration that, up to the date of the progress claim, the Contractor has complied with all lawful obligations with

respect to the Labour Conditions and that, in respect of the Work, all lawful obligations of the Contractor to its Subcontractors and Suppliers, referred to collectively in the declaration as “subcontractors and suppliers”, have been fully discharged.

- 2) Within 10 days of receipt of a progress claim and statutory declaration from the Contractor, Canada shall inspect, or cause to have inspected, the part of the Work and the Material described in the progress claim, and shall issue a progress report to the Contractor, that indicates the value of the part of the Work and the Material described in the progress claim that, in the opinion of Canada
  - (a) is in accordance with the Contract; and
  - (b) was not included in any other progress report relating to the Contract.
- 3) Subject to GC5.2 AMOUNT PAYABLE, and paragraph 5) of GC5.4, Canada shall pay the Contractor an amount that is equal to
  - (a) 95 percent of the value that is indicated in Canada's progress report if a labour and material payment bond has been furnished by the Contractor; or
  - (b) 90 percent of the value that is indicated in Canada's progress report if a labour and material payment bond has not been furnished by the Contractor.
- 4) Canada shall pay the amount referred to in paragraph 3) of GC5.4 not later than
  - (a) 30 days after receipt by Canada of both a progress claim and a statutory declaration referred to in paragraph 1) of GC5.4; or
  - (b) 15 days after receipt by Canada of the Contractor's progress schedule or updated progress schedule, in accordance with GC3.1 PROGRESS SCHEDULE,whichever is later.
- 5) In the case of the Contractor's first progress claim, it is a condition precedent to Canada's obligation under paragraph 3) of GC5.4 that the Contractor has provided all necessary documentation required by the Contract for the first progress claim.

#### **GC5.5 SUBSTANTIAL PERFORMANCE OF THE WORK**

- 1) If, at any time before the issuance of a Certificate of Completion, Canada determines that the Work has reached Substantial Performance as described in subparagraph 1) (b) of GC1.1.4 SUBSTANTIAL PERFORMANCE, Canada shall issue a Certificate of Substantial Performance to the Contractor. The Certificate of Substantial Performance shall state or describe
  - (a) the date of Substantial Performance;
  - (b) the parts of the Work not completed to the satisfaction of Canada; and
  - (c) all things that must be done by the Contractor before a Certificate of Completion is issued and before the 12-month warranty period referred to in GC3.13 WARRANTY AND RECTIFICATION OF DEFECTS IN WORK commences for the said parts and all the said things.



- 2) The issuance of a Certificate of Substantial Performance does not relieve the Contractor from the Contractor's obligations under GC3.11 DEFECTIVE WORK.
- 3) Subject to GC5.2 AMOUNT PAYABLE and paragraph 4) of GC5.5, Canada shall pay the Contractor the amount referred to in paragraph 1) of GC5.2 AMOUNT PAYABLE, less the aggregate of
  - (a) the sum of all payments that were made pursuant to GC5.4 PROGRESS PAYMENT;
  - (b) an amount that is equal to Canada's estimate of the cost to Canada of rectifying defects described in the Certificate of Substantial Performance; and
  - (c) an amount that is equal to Canada's estimate of the cost to Canada of completing the parts of the Work described in the Certificate of Substantial Performance other than defects listed therein.
- 4) Canada shall pay the amount referred to in paragraph 3) of GC5.5 not later than
  - (a) 30 days after the date of issue of a Certificate of Substantial Performance, or
  - (b) 15 days after the Contractor has delivered to Canada
    - (i) a statutory declaration containing a declaration by the Contractor that up to the date of the Certificate of Substantial Performance, the Contractor has complied with all lawful obligations with respect to the Labour Conditions, discharged all its lawful obligations to its Subcontractors and Suppliers in respect of the work under the Contract, and discharged its lawful obligations referred to in GC1.8 LAWS, PERMITS AND TAXES;
    - (ii) evidence of compliance with workers' compensation legislation in accordance with GC1.9 WORKERS' COMPENSATION; and
    - (iii) an update of the progress schedule in accordance with the requirements of GC3.1 PROGRESS SCHEDULE;

whichever is later.

#### **GC5.6 FINAL COMPLETION**

- 1) When Canada is of the opinion that the Contractor has complied with the Contract and all orders and directions made pursuant thereto, and that the Work has been completed as described in GC1.1.5 COMPLETION, Canada shall issue a Certificate of Completion to the Contractor and, if the Work or a portion of the Work is subject to a Unit Price Arrangement, Canada shall issue a Certificate of Measurement that shall, subject to GC8, be binding upon and conclusive between Canada and the Contractor as to the quantities referred to therein.
- 2) Subject to GC5.2 AMOUNT PAYABLE and paragraph 3) of GC5.6, Canada shall pay the Contractor the amount referred to in GC5.2 AMOUNT PAYABLE, less the aggregate of the sum of all payments that were made pursuant to GC5.4 PROGRESS PAYMENT and GC5.5 SUBSTANTIAL PERFORMANCE OF WORK.
- 3) Canada shall pay the amount referred to in paragraph 2) of GC5.6 not later than
  - (a) 60 days after the date of issue of a Certificate of Completion; or

- (b) 15 days after the Contractor has delivered to Canada
  - (i) a statutory declaration which contains a declaration by the Contractor that all of the Contractor's lawful obligations and any lawful claims against the Contractor that arose out of the performance of the Contract have been discharged and satisfied; and
  - (ii) evidence of compliance with workers' compensation legislation in accordance with GC1.9 WORKERS' COMPENSATION;

whichever is later.

#### **GC5.7 PAYMENT NOT BINDING ON CANADA**

- 1) Neither acceptance of a progress claim or progress report, nor any payment made by Canada under the Contract, nor partial or entire use or occupancy of the Work by Canada shall constitute an acceptance by Canada of any portion of the Work or Material that is not in accordance with the requirements of the Contract.

#### **GC5.8 CLAIMS AND OBLIGATIONS**

- 1) The Contractor shall discharge all the Contractor's lawful obligations and shall satisfy all lawful claims against the Contractor arising out of the performance of the Work at least as often as the Contract requires Canada to pay the Contractor.
- 2) Whenever requested to do so by Canada, the Contractor shall make a statutory declaration declaring to the existence and condition of any obligations and claims against the Contractor arising out of the performance of the Work.
- 3) In order to discharge lawful obligations of and satisfy lawful claims against the Contractor or its Subcontractors arising out of the performance of the Contract, Canada may pay an amount that is due and payable to the Contractor directly to the claimant. Such payment is, to the extent of the payment, a discharge of Canada's liability to the Contractor under the Contract and may be deducted from any amount payable to the Contractor under the Contract.
- 4) For the purposes of paragraph 3) of GC5.8, and subject to paragraph 6) of GC5.8, a claim or obligation shall be considered lawful when it is so determined by
  - (a) a court of legal jurisdiction;
  - (b) an arbitrator duly appointed to arbitrate the claim; or
  - (c) the written consent of the Contractor authorizing payment of the claim or obligation.
- 5) If a claim or obligation would have been subject to the provisions of Provincial or Territorial lien legislation or, in the Province of Quebec, the law relating to legal hypothecs had the Contractor been performing the Work for an entity other than Canada
  - (a) such amount as may be paid by Canada pursuant to paragraphs 3) and 4) of GC5.8 shall not exceed the amount that the Contractor would have been obliged to pay had the provisions of such legislation or law been applicable to the Work;

- (b) a claimant need not comply with the provisions of such legislation, setting out the steps by way of notice, registration or otherwise as might have been necessary to preserve or perfect any claim for lien or privilege which the claimant might have had; and
  - (c) for the purposes of determining the entitlement of a claimant, the notice required by paragraph 8) of GC5.8 shall be deemed to replace the registration or provision of notice after the performance of work as required by any applicable legislation and no claim shall be deemed to have expired, become void or unenforceable by reason of the claimant not commencing any action within the time prescribed by such legislation.
- 6) The Contractor shall, at the request of any claimant, submit to binding arbitration those questions that need to be answered to establish the entitlement of the claimant to payment. The arbitration shall have as parties to it any Subcontractor or Supplier to whom the claimant supplied Material, performed work or rented equipment should such Subcontractor or Supplier wish to be adjoined, and Canada shall not be a party to such arbitration. Subject to any agreement between the Contractor and the claimant, the arbitration shall be conducted in accordance with the governing Provincial or Territorial legislation applicable to the site of the Work.
- 7) Paragraph 3) of GC5.8 shall apply only to claims and obligations
- (a) the notification of which has set forth the amount claimed to be owing and the person who by contract is primarily liable and has been received by Canada in writing before final payment is made to the Contractor pursuant to GC5.6 FINAL COMPLETION, and within 120 days of the date on which the claimant
    - (i) should have been paid in full under the claimant's contract with the Contractor, its Subcontractor or Supplier if the claim is for money that was lawfully required to be held back from the claimant; or
    - (ii) performed the last of the services, work or labour, or furnished the last of the Material pursuant to the claimant's contract with the Contractor or its Subcontractor or Supplier where the claim is for money not lawfully required to be held back from the claimant; and
  - (b) the proceedings to determine the right to payment of which, pursuant to paragraph 5) of GC5.8, shall have commenced within one year from the date that the notification required by subparagraph 7)(a) of GC5.8 was received by Canada.
- 8) Upon receipt of a notice of claim, Canada may withhold, from any amount that is due and payable to the Contractor pursuant to the Contract, the full amount of the claim or any portion thereof.
- 9) Canada shall notify the Contractor in writing in a timely manner of receipt of any claim and of the intention of Canada to withhold funds. At any time thereafter and until payment is made to the claimant, the Contractor may be entitled to post, with Canada, security in a form acceptable to Canada in an amount equal to the value of the claim, and upon receipt of such security Canada shall release to the Contractor any funds that would be otherwise payable to the Contractor, that were withheld pursuant to the provisions of this clause in respect of the claim of any claimant for whom the security stands.

**GC5.9 RIGHT OF SETOFF**

- 1) Without limiting any right of setoff or deduction given or implied by law or elsewhere in the Contract, Canada may set off any amount payable to Canada by the Contractor under the

Contract, or under any current contract, against any amount payable to the Contractor under the Contract.

- 2) For the purposes of paragraph 1) of GC5.9, "current contract" means a contract between Canada and the Contractor
  - (a) under which the Contractor has an undischarged obligation to perform or supply work, labour or material; or
  - (b) in respect of which Canada has, since the date of the Contract, exercised any right to take the work that is the subject of that contract out of the Contractor's hands.

#### **GC5.10 ASSESSMENTS AND DAMAGES FOR LATE COMPLETION**

- 1) For the purposes of this clause
  - (a) the Work shall be deemed to be completed on the date of the Certificate of Completion; and
  - (b) the "period of delay" means the number of days commencing on the day fixed for completion of the Work and ending on the day immediately preceding the day on which the Work is completed but does not include any day within a period of extension granted pursuant to GC6.5 DELAYS AND EXTENSION OF TIME and any other day on which, in the opinion of Canada, completion of the Work was delayed for reasons beyond the control of the Contractor.
- 2) If the Contractor does not complete the Work by the day fixed for its completion but completes it thereafter, the Contractor shall pay Canada an amount equal to the aggregate of
  - (a) all salaries, wages and travelling expenses incurred by Canada in respect of persons overseeing the performance of the Work during the period of delay;
  - (b) the cost incurred by Canada as a result of the inability to use the completed Work for the period of delay; and
  - (c) all other expenses and damages incurred or sustained by Canada during the period of delay as a result of the Work not being completed by the day fixed for its completion.
- 3) Canada may waive the right of Canada to the whole or any part of the amount payable by the Contractor pursuant to paragraph 2) of GC5.10 if, in the opinion of Canada, it is in the public interest to do so.

#### **GC5.11 DELAY IN MAKING PAYMENT**

- 1) Notwithstanding GC1.5 TIME OF THE ESSENCE, any delay by Canada in making any payment when it is due pursuant to GC5 TERMS OF PAYMENT, shall not be a breach of the Contract by Canada.
- 2) Subject to paragraph 3) of GC5.11, Canada shall pay to the Contractor simple interest at the Average Bank Rate plus 3 percent per annum on any amount that is overdue pursuant to paragraph 3) of GC5.1 INTERPRETATION, and the interest shall apply from and include the day such amount became overdue until the day prior to the date of payment.

- 3) Interest shall be paid without demand by the Contractor except that
  - (a) in respect of amounts that are less than 15 days overdue, no interest shall be paid in respect of payment made within such 15 days unless the Contractor so demands after such amounts have become due and payable; and
  - (b) interest shall not be payable or paid on overdue advance payments, if any.

**GC5.12 INTEREST ON SETTLED CLAIMS**

- 1) For the purposes of this clause, a claim means a disputed amount subject to negotiation between Canada and the Contractor under the Contract.
- 2) A claim is deemed to have been settled when an agreement in writing is signed by Canada and the Contractor setting out the amount of the claim to be paid by Canada and the items of work for which the said amount is to be paid.
- 3) A settled claim is deemed to be outstanding from the day immediately following the date the said claim would have been due and payable under the Contract had it not been disputed.
- 4) Canada shall pay to the Contractor simple interest on the amount of a settled claim at the Average Bank Rate plus 3 percent per annum from the date the settled claim was deemed to be outstanding until the day prior to the date of payment.

**GC5.13 RETURN OF SECURITY DEPOSIT**

- 1) After a Certificate of Substantial Performance has been issued, and if the Contractor is not in breach of nor in default under the Contract, Canada shall return to the Contractor all or any part of a Security Deposit that, in the opinion of Canada, is not required for the purposes of the Contract.
- 2) After a Certificate of Completion has been issued, Canada shall return to the Contractor the remainder of any security deposit unless the Contract stipulates otherwise.
- 3) If the security deposit was paid into the Consolidated Revenue Fund of Canada, Canada shall pay interest thereon to the Contractor at a rate established pursuant to section 21(2) of the [\*Financial Administration Act \(FAA\)\*](#).

**GC6 DELAYS AND CHANGES IN THE WORK**

- GC6.1 CHANGES IN THE WORK
- GC6.2 CHANGES IN SUBSURFACE CONDITIONS
- GC6.3 HUMAN REMAINS, ARCHAEOLOGICAL REMAINS AND ITEMS OF HISTORICAL OR SCIENTIFIC INTEREST
- GC6.4 DETERMINATION OF PRICE
  - GC6.4.1 Price Determination Prior to Undertaking Changes
  - GC6.4.2 Price Determination Following Completion of Changes
  - GC6.4.3 Price Determination - Variations in Tendered Quantities
- GC6.5 DELAYS AND EXTENSION OF TIME

**GC6.1 CHANGES IN THE WORK**

- 1) At any time before issuance of a Certificate of Completion, Canada may issue orders for additions, deletions or other changes to the Work, or changes in the location or position of the whole or any part of the Work, if the addition, deletion, change or other revision is deemed by Canada to be consistent with the general intent of the Contract.
- 2) An order referred to in paragraph 1) of GC6.1 shall be in writing and given to the Contractor in accordance with GC2.3 NOTICES.
- 3) Upon receipt of an order, the Contractor shall promptly perform the work in accordance with the order as if the order had appeared in and been part of the original Contract.
- 4) If anything done or omitted by the Contractor pursuant to an order increases or decreases the cost of the Work to the Contractor, payment for the work shall be made in accordance with GC6.4 DETERMINATION OF PRICE.

**GC6.2 CHANGES IN SUBSURFACE CONDITIONS**

- 1) If, during the performance of the Work, the Contractor encounters subsurface conditions that are substantially different from the subsurface conditions described in the tender documents supplied to the Contractor, or a reasonable assumption of fact based thereon, the Contractor shall give notice to Canada immediately upon becoming aware of the situation.
- 2) If the Contractor is of the opinion that the Contractor may incur or sustain any extra expense or any loss or damage that is directly attributable to the changed subsurface conditions, the Contractor shall within 10 days of the date the changed subsurface conditions were encountered, give Canada written notice of intention to claim for that extra expense, loss or damage.
- 3) If the Contractor has given a notice referred to in paragraph 2) of GC6.2, the Contractor shall give Canada a written claim for extra expense, loss or damage no later than 30 days after the date that a Certificate of Substantial Performance is issued.
- 4) A written claim referred to in paragraph 3) of GC6.2 shall contain a sufficient description of the facts and circumstances of the occurrence that is the subject of the claim to enable Canada to determine whether or not the claim is justified, and the Contractor shall supply such further and other information for that purpose as Canada requires.
- 5) If Canada determines that a claim referred to in paragraph 3) of GC6.2 is justified, Canada shall make an extra payment to the Contractor in an amount that is calculated in accordance with GC6.4 DETERMINATION OF PRICE.

- 6) If, in the opinion of Canada, the Contractor effects a saving of expenditure that is directly attributable to a substantial difference between the information relating to subsurface conditions at the site of the Work that is contained in the tender documents, or a reasonable assumption of fact based thereon, and the actual subsurface conditions encountered by the Contractor, the Contract Amount shall be reduced by the amount of the saving of expenditure determined in accordance with GC6.4 DETERMINATION OF PRICE.
- 7) If the Contractor fails to give a notice referred to in paragraph 2) of GC6.2 and a claim referred to in paragraph 3) of GC6.2 within the times stipulated, an extra payment shall not be made to the Contractor in respect of the occurrence.
- 8) Canada does not warrant the content expressed in any subsurface report available for the perusal of the Contractor that does not form part of the tender and contract documents.

### **GC6.3 HUMAN REMAINS, ARCHAEOLOGICAL REMAINS AND ITEMS OF HISTORICAL OR SCIENTIFIC INTEREST**

- 1) For the purposes of this clause
  - (a) "human remains" means the whole or any part of a deceased human being, irrespective of the time of death;
  - (b) "archaeological remains" are items, artefacts or things made, modified or used by human beings in antiquity and may include, but not be limited to, stone, wood or iron structures or monuments, dump deposits, bone artefacts, weapons, tools, coins, and pottery; and
  - (c) "items of historical or scientific interest" are naturally occurring or manufactured objects or things of any age that are not archaeological remains but may be of interest to society because of their historical or scientific significance, value, rarity, natural beauty, or other quality.
- 2) If, during the course of the Work, the Contractor encounters any object, item or thing which is described in paragraph 1) of GC6.3 or which resembles any object, item or thing described in paragraph 1) of GC6.3, the Contractor shall
  - (a) take all reasonable steps, including stopping work in the affected area, to protect and preserve the object, item or thing;
  - (b) immediately notify Canada of the circumstances in writing; and
  - (c) take all reasonable steps to minimize additional costs that may accrue as a result of any work stoppage.
- 3) Upon receipt of a notification in accordance with subparagraph 2)(b) of GC6.3, Canada shall promptly determine whether the object, item or thing is one described in, or contemplated by paragraph 1) of GC6.3, and shall notify the Contractor in writing of any action to be performed, or work to be carried out, by the Contractor as a result of Canada's determination.
- 4) Canada may, at any time, enlist the services of experts to assist in the investigation, examination, taking of measurements or other such recordings, placing of permanent protection around or removing of the object, item or thing encountered by the Contractor, and the Contractor shall, to the satisfaction of Canada, allow them access and co-operate with them in the carrying out of their duties and obligations.

- 5) Human remains, archaeological remains and items of historical or scientific interest encountered at the site of the Work shall be deemed to be the property of Canada.
- 6) Except as may be otherwise provided for in the Contract, the provisions of GC6.4 DETERMINATION OF PRICE and GC6.5 DELAYS AND EXTENSION OF TIME shall apply.

## **GC6.4 DETERMINATION OF PRICE**

### **GC6.4.1 Price Determination Prior to Undertaking Changes**

- 1) If a Lump Sum Arrangement applies to the Contract or a part thereof, the price of any change shall be the aggregate estimated cost of labour, Plant and Material that is required for the change as agreed upon in writing by the Contractor and Canada plus a negotiated allowance for supervision, co-ordination, administration, overhead, margin and the risk of undertaking the work within the stipulated amount.
- 2) If a Unit Price Arrangement applies to the Contract or a part thereof, the Contractor and Canada may, by agreement in writing, add items, units of measurement, estimated quantities and prices per unit to the Unit Price Table.
- 3) A price per unit referred to in paragraph 2) of GC6.4.1 shall be determined on the basis of the aggregate estimated cost of labour, Plant and Material that is required for the additional item as agreed upon by the Contractor and Canada, plus a negotiated allowance.
- 4) To facilitate approval of the price of the change or the additional price per unit as applicable, the Contractor shall submit a cost estimate breakdown identifying, as a minimum, the estimated cost of labour, Plant, Material, each subcontract amount, and the amount of the negotiated allowance.
- 5) If no agreement is reached as contemplated in paragraph 1) of GC6.4.1, the price shall be determined in accordance with GC6.4.2.
- 6) If no agreement is reached, as contemplated in paragraphs 2) and 3) of GC6.4.1, Canada shall determine the class and the unit of measurement of the item of labour, Plant or Material and the price per unit shall be determined in accordance with GC6.4.2.

### **GC6.4.2 Price Determination Following Completion of Changes**

- 1) If it is not possible to predetermine, or if there is failure to agree upon the price of a change in the Work, the price of the change shall be equal to the aggregate of
  - (a) all reasonable and proper amounts actually expended or legally payable by the Contractor in respect of the labour, Plant and Material that fall within one of the classes of expenditure described in paragraph 2) of GC6.4.2, that are directly attributable to the performance of the Contract;
  - (b) an allowance for profit and all other expenditures or costs, including overhead, general administration costs, financing and interest charges, in an amount that is equal to 10 percent of the sum of the expenses referred to in subparagraph 1)(a) of GC6.4.2; and
  - (c) interest on the amounts determined under subparagraphs 1)(a) and 1)(b) of GC6.4.2 calculated in accordance with GC5.12 INTEREST ON SETTLED CLAIMS;



- 2) The cost of labour, Plant and Material referred to in subparagraph 1)(a) of GC6.4.2 shall be limited to the following categories of expenditure:
- (a) payments to Subcontractors and Suppliers;
  - (b) wages, salaries, bonuses and, if applicable, travel and lodging expenses of employees of the Contractor located at the site of the Work and that portion of wages, salaries, bonuses and, if applicable, travel and lodging expenses of personnel of the Contractor generally employed at the head office or at a general office of the Contractor provided they are actually and properly engaged on the Work under the Contract;
  - (c) assessments payable under any statutory authority relating to workers' compensation, employment insurance, pension plan or holidays with pay, provincial health or insurance plans, environmental reviews, and Applicable Taxes collection costs;
  - (d) rent that is paid for Plant, or an amount equivalent to the said rent if the Plant is owned by the Contractor, that is necessary for and used in the performance of the Work, if the rent or the equivalent amount is reasonable and use of that Plant has been approved by Canada;
  - (e) payments for maintaining and operating Plant necessary for and used in the performance of the Work, and payments for effecting repairs thereto that, in the opinion of Canada, are necessary for the proper performance of the Contract, other than payments for any repairs to the Plant arising out of defects existing before its allocation to the Work;
  - (f) payments for Material that is necessary for and incorporated in the Work, or that is necessary for and consumed in the performance of the Contract;
  - (g) payments for preparation, delivery, handling, erection, installation, inspection, protection and removal of the Plant and Material necessary for and used in the performance of the Contract; and
  - (h) any other payments made by the Contractor with the approval Canada that are necessary for the performance of the Contract in accordance with the Contract Documents.

#### **GC6.4.3 Price Determination - Variations in Tendeded Quantities**

- 1) Except as provided in paragraphs 2), 3), 4) and 5) of GC6.4.3, if it appears that the final quantity of labour, Plant and Material under a price per unit item shall exceed or be less than the estimated tendered quantity, the Contractor shall perform the Work or supply the Plant and Material required to complete the item and payment shall be made for the actual Work performed or Plant and Material supplied at the price per unit set out in the Contract.
- 2) If the final quantity of the price per unit item exceeds the estimated tendered quantity by more than 15 percent, either party to the Contract may make a written request to the other party to negotiate an amended price per unit for that portion of the item which exceeds 115 percent of the estimated tendered quantity, and to facilitate approval of any amended price per unit, the Contractor shall, on request, provide Canada with
- (a) detailed records of the actual cost to the Contractor of performing or supplying the tendered quantity for the price per unit item up to the time the negotiation was requested; and

- (b) the estimated unit cost of labour, Plant and Material required for the portion of the item that is in excess of 115 percent of the tendered quantity.
- 3) If agreement is not reached as contemplated in paragraph 2) of GC6.4.3, the price per unit shall be determined in accordance with GC6.4.2.
  - 4) If it appears that the final quantity of labour, Plant and Material under a price per unit item shall be less than 85 percent of the estimated tendered quantity, either party to the Contract may make a written request to the other party to negotiate a change to the price per unit for the item if
    - (a) there is a demonstrable difference between the unit cost to the Contractor of performing or supplying the estimated tendered quantity and the unit cost to the Contractor for performing or supplying the final quantity; and
    - (b) the difference in unit cost is due solely to the decrease in quantity and not to any other cause.
  - 5) For the purposes of the negotiation referred to in paragraph 4) of GC6.4.3
    - (a) the onus of establishing, justifying and quantifying a proposed change lies with the party making the request for negotiation; and
    - (b) in no event shall the total price for an item that has been amended as a result of a reduction in quantity pursuant to paragraph 4) of GC6.4.3 exceed the amount that would have been payable to the Contractor had 85 percent of the tendered quantity actually been performed or supplied.

#### **GC6.5 DELAYS AND EXTENSION OF TIME**

- 1) Upon application of the Contractor made before the date first fixed for completion of the Work or before any other date previously fixed under this clause, Canada may extend the time for completion of the Work by fixing a new date if Canada determines that causes beyond the control of the Contractor have delayed its completion.
- 2) The Contractor's application shall be accompanied by the written consent of the bonding company whose bond forms part of the Contract Security.
- 3) Subject to paragraph 4) of GC6.5, no payment, other than a payment that is expressly stipulated in the Contract, shall be made by Canada to the Contractor for any extra expense, loss or damage incurred or sustained by the Contractor due to delay, whether or not the delay is caused by circumstances beyond the control of the Contractor.
- 4) If the Contractor incurs or sustains any extra expense or any loss or damage that is directly attributable to any neglect or delay that occurs after the date of the Contract on the part of Canada in providing any information or in doing any act that the Contract either expressly requires Canada to do or that would ordinarily be done by an owner in accordance with the practice of the trade, the Contractor shall give Canada written notice of intention to claim for that extra expense or loss or damage within ten working days of the date the neglect or delay first occurred.
- 5) When the Contractor has given a notice referred to in paragraph 4) of GC6.5, the Contractor shall give Canada a written claim for the extra expense, loss or damage no later than 30 days after the date that a Certificate of Completion is issued and not afterwards.

- 6) A written claim referred to in paragraph 5) of GC6.5 shall contain a sufficient description of the facts and circumstances of the occurrence that is the subject of the claim to enable Canada to determine whether or not the claim is justified and the Contractor shall supply such further and other information for that purpose as Canada may require.
- 7) If Canada determines that a claim referred to in paragraph 5) of GC6.5 is justified, Canada shall make an extra payment to the Contractor in an amount that is calculated in accordance with GC6.4 DETERMINATION OF PRICE.
- 8) If the Contractor fails to give a notice referred to in paragraph 4) and a claim referred to in paragraph 5) of GC6.5 within the times stipulated, an extra payment shall not be made to the Contractor in respect of the occurrence.

**GC7 DEFAULT, SUSPENSION OR TERMINATION OF CONTRACT**

GC7.1 TAKING THE WORK OUT OF THE CONTRACTOR'S HANDS

GC7.2 SUSPENSION OF WORK

GC7.3 TERMINATION OF CONTRACT

GC7.4 SECURITY DEPOSIT - FORFEITURE OR RETURN

**GC7.1 TAKING THE WORK OUT OF THE CONTRACTOR'S HANDS**

- 1) By giving notice in writing to the Contractor in accordance with GC2.3 NOTICES, Canada, without any other authorization, may take all or any part of the Work out of the Contractor's hands, and may employ such means as Canada sees fit to have the Work completed if the Contractor:
  - (a) fails to remedy any delay in the commencement or default in the diligent performance of the Work to the satisfaction of Canada within six days of Canada giving notice to the Contractor in writing in accordance with GC2.3 NOTICES;
  - (b) defaults in the completion of any part of the Work within the time fixed for its completion by the Contract;
  - (c) becomes insolvent, or has committed an act of bankruptcy, and has neither made a proposal to its creditors nor filed a notice of intention to make such a proposal, pursuant to the [\*Bankruptcy and Insolvency Act\*](#);
  - (d) abandons the work;
  - (e) makes an assignment of the Contract without the consent required by GC1.16 ASSIGNMENT; or
  - (f) otherwise fails to observe or perform any of the provisions of the Contract.
- 2) If the whole or any part of the Work is taken out of the Contractor's hands, the Contractor's right to any further payment that is due or accruing due under the Contract is, subject only to paragraph 3) of GC7.1, extinguished, and the Contractor is liable to pay Canada, upon demand, an amount that is equal to the amount of all loss and damage incurred or sustained by Canada in respect of the Contractor's failure to complete the Work.
- 3) If the whole or any part of the Work that is taken out of the Contractor's hands is completed by Canada, Canada may pay the Contractor the amount, if any, of the holdback or a progress claim as determined by Canada that had accrued and was due prior to the date on which the Work was taken out of the Contractor's hands and that is not required for the purposes of having the Work performed or of compensating Canada for any other loss or damage incurred or sustained by reason of the Contractor's default.
- 4) The taking of the Work or any part thereof out of the Contractor's hands does not relieve the Contractor from any obligation under the Contract or imposed by law except the obligation to complete the performance of that part of the Work that was taken out of the Contractor's hands.
- 5) If the Work or any part thereof is taken out of the Contractor's hands, all Plant and Material and the interest of the Contractor, or its suppliers or subcontractors at any tier, in all real property, licences, powers and privileges acquired, used or provided by the Contractor, or its suppliers or subcontractors at any tier, under the Contract shall continue to be the property of Canada without compensation.

- 6) When Canada certifies that any Plant, Material, or any interest of the Contractor is no longer required for the purposes of the Work, or that it is not in the interests of Canada to retain that Plant, Material, or interest, it shall revert to the Contractor.
- 7) If the Contractor has become insolvent or has committed an act of bankruptcy, and has either made a proposal to its creditors or filed a notice of intention to make such a proposal, pursuant to the Bankruptcy and Insolvency Act, the Contractor shall immediately forward a copy of the proposal or the notice of intention to Canada.

#### **GC7.2 SUSPENSION OF WORK**

- 1) When, in Canada's opinion, it is in the public interest to do so, Canada may require the Contractor to suspend performance of the Work either for a specified or an unspecified period, by giving a notice of suspension in writing to the Contractor in accordance with GC2.3 NOTICES.
- 2) When a notice of suspension is received by the Contractor, the Contractor shall suspend all operations in respect of the Work except those that Canada determines are necessary for the care and preservation of the Work, Plant and Material.
- 3) During a period of suspension, the Contractor shall not remove any part of the Work, Plant or Material from its site without the consent of Canada.
- 4) If a period of suspension is 60 days or less, the Contractor shall resume the performance of the Work on the expiration of that period, and the Contractor is entitled to be paid the extra costs necessarily incurred by the Contractor as a result of the suspension, determined in accordance with GC6.4 DETERMINATION OF PRICE.
- 5) If a period of suspension is more than 60 days, Canada and the Contractor may agree that the performance of the Work shall be continued by the Contractor, and the Contractor shall resume performance of the Work subject to any terms and conditions agreed upon by Canada and the Contractor. If Canada and the Contractor do not agree that performance of the Work shall be continued by the Contractor, or upon the terms and conditions under which the Contractor shall continue the Work, the notice of suspension shall be deemed to be a notice of termination pursuant to GC7.3 TERMINATION OF CONTRACT.

#### **GC7.3 TERMINATION OF CONTRACT**

- 1) Canada may terminate the Contract at any time by giving a notice of termination in writing to the Contractor in accordance with GC2.3 NOTICES.
- 2) If the Contractor receives a notice of termination, the Contractor shall forthwith cease all operations in performance of the Contract, subject to any conditions stipulated in the notice.
- 3) Subject to paragraph 4) of GC7.3, if the Contract is terminated, Canada shall pay the Contractor an amount determined to be due to the Contractor pursuant to GC6.4 DETERMINATION OF PRICE less the aggregate of all amounts that were paid to the Contractor by Canada and all amounts that are due to Canada from the Contractor pursuant to the Contract.
- 4) In no event shall the total amount payable by Canada to the Contractor exceed the amount, calculated in accordance with GC5 TERMS OF PAYMENT, that would have been payable to the Contractor had the Contractor completed the Work.

- 5) Payment to the Contractor, if any, shall be made as soon as practicable under the circumstances.

**GC7.4 SECURITY DEPOSIT - FORFEITURE OR RETURN**

- 1) If the Work is taken out of the Contractor's hands, or the Contractor is in breach of, or in default under, the Contract, Canada may convert a security deposit to Canada's own use.
- 2) If Canada converts a security deposit, the amount realized shall be deemed to be an amount due from Canada to the Contractor under the Contract.
- 3) Any balance of the amount realized that remains after payment of all losses, damage and claims of Canada and others shall be paid by Canada to the Contractor if, in the opinion of Canada, it is not required for the purposes of the Contract.

**GC8 DISPUTE RESOLUTION**

- GC8.1 INTERPRETATION
- GC8.2 CONSULTATION AND CO-OPERATION
- GC8.3 NOTICE OF DISPUTE
- GC8.4 NEGOTIATION
- GC8.5 MEDIATION
- GC8.6 CONFIDENTIALITY
- GC8.7 SETTLEMENT
- GC8.8 RULES FOR MEDIATION OF DISPUTES
  - GC8.8.1 Interpretation
  - GC8.8.2 Application
  - GC8.8.3 Communication
  - GC8.8.4 Appointment of Project Mediator
  - GC8.8.5 Confidentiality
  - GC8.8.6 Time and Place of Mediation
  - GC8.8.7 Representation
  - GC8.8.8 Procedure
  - GC8.8.9 Settlement Agreement
  - GC8.8.10 Termination of Mediation
  - GC8.8.11 Costs
  - GC8.8.12 Subsequent Proceedings

**GC8.1 INTERPRETATION**

- 1) "dispute" means any disagreement regarding any issue identified by the Contractor in the notice submitted to Canada in accordance with paragraph 2 of GC8.3 NOTICE OF DISPUTE, and includes any claim by the Contractor arising from such disagreement and any counterclaim by Canada, but does not include any claim by either party for punitive or exemplary damages, injury to persons, death, or any claim based on an allegation of libel or slander.
- 2) The alternative dispute resolution procedures set out in GC8, do not apply to any claim by Canada against the Contractor except any counterclaim in a dispute as defined in paragraph 1 of GC8.1, including, but not limited to, any claim of setoff regarding any amount due to Canada under GC5.10 ASSESSMENT AND DAMAGES FOR LATE COMPLETION.

**GC8.2 CONSULTATION AND CO-OPERATION**

- 1) The parties agree to maintain open and honest communication throughout the performance of the Contract.
- 2) The parties agree to consult and co-operate with each other in the furtherance of the Work and the resolution of problems or differences that may arise.

**GC8.3 NOTICE OF DISPUTE**

- 1) Any difference between the parties to the Contract of any nature arising out of or in connection with the Contract which could result in a claim by the Contractor against Canada, and which is not settled by consultation and co-operation as envisaged in GC8.2 CONSULTATION AND CO-OPERATION, shall be resolved in the first instance by Canada, whose written decision or direction shall be final and binding subject only to the provisions of

GC8. Such written decision or direction includes, but is not limited to, any written decision or direction by Canada under any provision of the General Conditions.

- 2) The Contractor shall be deemed to have accepted the decision or direction of Canada referred to in paragraph 1) of GC8.3 and to have expressly waived and released Canada from any claim in respect of the particular matter dealt with in that decision or direction unless, within 15 working days after receipt of the decision or direction, the Contractor submits to Canada a written notice of dispute requesting formal negotiation under GC8.4 NEGOTIATION. Such notice shall refer specifically to GC8.4 NEGOTIATION, and shall specify the issues in contention and the relevant provisions of the Contract.
- 3) The giving of a written notice in accordance with paragraph 2) of GC8.3 shall not relieve the Contractor from complying with the decision or direction that is the subject of the dispute. Such compliance, however, shall not be construed as an admission by the Contractor of the correctness of such decision or direction.
- 4) If a dispute is not resolved promptly, Canada shall give such instructions as, in Canada's opinion, are necessary for the proper performance of the Work and to prevent delays pending a resolution of the matter. Unless Canada terminates the Contract, orders the Contractor to suspend the Work, or takes the Work out of the hands of the Contractor, the Contractor shall continue to perform the Work in accordance with the provisions and requirements of the Contract and the instructions of Canada. Such performance shall not prejudice any claim that the Contractor may have.
- 5) Nothing in GC8 relieves the Contractor from its obligation to provide any other notice required by the Contract within the time specified in the Contract, including but not limited to, any notice required under GC6.2 CHANGES IN SUBSURFACE CONDITIONS.

#### **GC8.4 NEGOTIATION**

- 1) Within 10 working days after receipt by Canada of a notice referred to in paragraph 2) of GC8.3 NOTICE OF DISPUTE, or within such other period of time as may be mutually agreed to, the parties shall commence formal negotiations in order to resolve the dispute. Negotiations shall occur initially between representatives of the Contractor and Canada who play a direct supervisory role in the performance, administration or management of the Contract.
- 2) If the representatives referred to in paragraph 1) of GC8.4 are unable to resolve some or all of the issues which are the subject of the negotiations within 10 working days, the parties shall refer the remaining issues which are in dispute to a second level of negotiation between a principal or principals of the Contractor and a senior level manager or senior level managers representing Canada.
- 3) If negotiations fail to resolve the dispute within 30 working days from the date of delivery of the notice referred to in paragraph 2) of GC8.3 NOTICE OF DISPUTE, or within such longer period as may have been agreed to by the parties, the Contractor may, by giving written notice to Canada, in accordance with GC2.3 NOTICES, within 10 working days from the end of such period, request that mediation be undertaken to assist the parties to reach agreement on the outstanding issues.
- 4) If the Contractor does not request mediation within the period permitted by paragraph 3) of GC8.4, the Contractor shall be deemed to have accepted the decision or direction of Canada under paragraph 1) of GC8.3 NOTICE OF DISPUTE and to have expressly waived and released Canada from any claim in respect of the particular matter dealt with in that decision or direction.



**GC8.5 MEDIATION**

- 1) If the Contractor has requested mediation in accordance with paragraph 3) of GC8.4 NEGOTIATION, mediation shall be conducted in accordance with GC8.8 RULES FOR MEDIATION OF DISPUTES.
- 2) If a Project Mediator has not previously been appointed for the purposes of the Contract, a Project Mediator shall be appointed in accordance with GC8.8 RULES FOR MEDIATION OF DISPUTES forthwith after delivery of a notice in accordance with paragraph 3) of GC8.4 NEGOTIATION, requesting mediation.
- 3) If the dispute has not been resolved within
  - (a) Ten (10) working days following the appointment of a Project Mediator in accordance with paragraph 2) of GC8.5, if a Project Mediator was not previously appointed;
  - (b) Ten (10) working days following receipt by Canada of a written notice in accordance with paragraph 3) of GC8.4 NEGOTIATION, if a Project Mediator was previously appointed; or
  - (c) such other longer period as may have been agreed to by the parties;the Project Mediator shall terminate the mediation by giving written notice to the parties stating the effective date of termination.

**GC8.6 CONFIDENTIALITY**

- 1) All information exchanged during alternative dispute resolution procedures, by whatever means, shall be without prejudice and shall be treated as confidential by the parties and their representatives, unless otherwise required by law. However, evidence that is independently admissible or discoverable shall not be rendered inadmissible or non-discoverable by virtue of its use during an alternative dispute resolution process.

**GC8.7 SETTLEMENT**

- 1) Any agreement to settle all or any part of a dispute, by whatever means, shall be in writing and be signed by the parties or their authorized representatives.

**GC8.8 RULES FOR MEDIATION OF DISPUTES**

**GC8.8.1 Interpretation**

In these Rules

- 1) “Coordinator” means the person designated by Canada to act as the Dispute Resolution Coordinator.

**GC8.8.2 Application**

- 1) By mutual agreement, the parties may change or make additions to the Rules.

**GC8.8.3 Communication**

- 1) Written communications pursuant to these Rules shall be given in accordance with GC2.3 NOTICES.

**GC8.8.4 Appointment of Project Mediator**

- 1) The parties to the Contract may, by mutual consent, at any time after entry into the Contract, appoint a mediator (the "Project Mediator") to conduct mediation proceedings in accordance with these Rules for Mediation of Disputes, in regard to any dispute that may arise with regard to the interpretation, application or administration of the Contract. In this case, they shall jointly enter into a contract with the appointed Project Mediator, which contract shall be in a form drafted by the Coordinator and agreed to by the parties.
- 2) If the parties do not appoint a Project Mediator pursuant to paragraph 1) of GC8.8.4, the parties shall appoint a Project Mediator within 17 working days following receipt of a written notice from the Contractor, in accordance with GC2.3 NOTICES, requesting that mediated negotiations be undertaken in accordance with these Rules to assist the parties to reach agreement on any outstanding issues that may be in dispute. Any contract entered into with the appointed Project Mediator shall meet the requirements as set out for the contract described in paragraph 1) of GC8.8.4.
- 3) When mediation is requested by the Contractor pursuant to paragraph 3) of GC8.4 NEGOTIATION, if the parties have previously entered into a contract with a Project Mediator, the parties shall within 2 days send to both the Project Mediator and the Coordinator
  - (a) a copy of the notice requesting negotiation under paragraph 2) of GC8.3 NOTICE OF DISPUTE;
  - (b) a copy of Canada's written position in relation to the notice, the issues in contention and the relevant provisions of the contract; and
  - (c) a copy of the Contractor's written request for mediation required under paragraph 3) of GC8.4 NEGOTIATION.
- 4) If the parties have not agreed on a Project Mediator, the parties shall forthwith provide the Coordinator with the written materials referred to in subparagraphs 3)(a), 3)(b) and 3)(c) of GC8.8.4 together with a request that the Coordinator assist in the appointment of a mutually acceptable Project Mediator in accordance with these Rules.
- 5) Within 5 working days following receipt of the request and materials referred to in paragraph 4) of GC8.8.4, the Coordinator shall provide the parties with a list of qualified private sector mediators obtained from an independent and impartial entity, together with instructions to each party to individually and confidentially select and rank their preferred and fully acceptable choices of mediator in descending order. Each mediator listed shall be impartial and independent of the parties, and shall be an experienced and skilled commercial mediator, preferably with knowledge of the subject matter of the dispute.
- 6) Within 10 working days of receipt of the list referred to in paragraph 5) of GC8.8.4 each party shall comply with the instructions accompanying the list(s) and shall deliver the completed listing to the Coordinator.

- 7) Within 2 working days following receipt of the completed listings, the Coordinator shall select the highest common ranked mediator to act as Project Mediator for the purposes of the contract.
- 8) In the event of a tie, the Coordinator shall consult both parties to re-evaluate their rankings in order to assist the Coordinator in selecting a Project Mediator acceptable to both parties. If the parties cannot agree upon a Project Mediator, the Coordinator shall forthwith provide the parties with a second list of mediators and the procedure shall be repeated.
- 9) If the parties have not previously entered into a contract with a mutually acceptable Project Mediator, the Coordinator shall use reasonable efforts to negotiate a contract with a mutually acceptable Project Mediator on behalf of the parties, which contract shall incorporate or otherwise comply with the provisions of these Rules. If negotiations are unsuccessful, or if for other reason the individual is unwilling or unable to enter into a contract to act as Project Mediator, the Coordinator shall repeat the process with the second-highest common ranked mediator.
- 10) The parties agree that, upon successful completion of the negotiations referred to in paragraph 9) of GC8.8.4, they shall jointly enter into a contract with the selected Project Mediator, which contract shall be in a form drafted by the Coordinator and agreed to by the parties.
- 11) Upon execution of the contract with the Project Mediator referred to in paragraph 10) of GC8.8.4 the Coordinator shall provide the Project Mediator with copies of the documents referred to in paragraph 3) of GC8.8.4.

#### **GC8.8.5 Confidentiality**

- 1) Subject to paragraph 2) of GC8.8.5, and unless otherwise agreed in writing by the parties, the Project Mediator, the parties and their counsel or representatives shall keep confidential all matters and documents disclosed during mediation proceedings except where the disclosure is necessary for any implementation of any agreement reached or is required by law.
- 2) Evidence that is independently admissible or discoverable in any arbitral or judicial proceeding shall not be rendered inadmissible or non-discoverable by virtue of its use in mediation proceedings.
- 3) Neither party shall make transcripts, minutes or other records of a mediation conference.
- 4) The personal notes and written opinions of the Project Mediator made in relation to mediation are in the Project Mediator's sole possession and control, are confidential, and may not be used in any subsequent proceeding between the parties or where they are opposed in interest without the express written permission of the parties.
- 5) All information exchanged during mediation procedures, by whatever means, shall be without prejudice and shall be treated as confidential by the parties and their representatives, unless otherwise required by law.

#### **GC8.8.6 Time and Place of Mediation**

- 1) The Project Mediator, in consultation with the parties shall set the date, time and place of any mediation conference as soon as possible, bearing in mind that, subject to agreement to

the contrary between the parties, only 10 working days are available within which to attempt to settle the dispute.

#### **GC8.8.7 Representation**

- 1) Representatives of the parties may be accompanied at the mediation conference by legal counsel or any other person.
- 2) If the Project Mediator is a lawyer, the Project Mediator shall not provide legal advice to a party during the course of the mediation conference, but may recommend that a party obtain independent legal advice before finalizing a settlement agreement.

#### **GC8.8.8 Procedure**

- 1) The parties agree to an exchange of all facts, information and documents upon which they intend to rely in any oral or written presentation during the mediation. This exchange shall be completed no later than 2 working days prior to the date set for a mediation conference.
- 2) The Project Mediator shall be free to meet with the parties individually during a mediation conference if the Project Mediator is of the opinion that this may improve the chances of a mediated settlement, and either party may request such an individual meeting at any time.
- 3) The parties may agree to extend the 10 working days available for settlement of the dispute through mediation, and the Project Mediator shall record that agreement in writing.

#### **GC8.8.9 Settlement Agreement**

- 1) The parties shall record in writing any settlement agreement reached, with sufficient detail to ensure a clear understanding of
  - (a) the issues resolved;
  - (b) any obligations assumed by each party including criteria to determine if and when these obligations have been met; and
  - (c) the consequences of failure to comply with the agreement reached.
- 2) The parties agree to carry out the terms of a settlement agreement as soon as possible and, in any event, within any time periods specified in the agreement.

#### **GC8.8.10 Termination of Mediation**

- 1) Either party may withdraw from mediation at any time without reason and, in that event, the Project Mediator shall give each party a written notice terminating the mediation and establishing the effective date of termination.
- 2) If, in the opinion of the Project Mediator, either party fails to mediate in good faith or fails to comply with the terms of these Rules, or if the Project Mediator, at any time during mediation, is of the opinion that further negotiations will fail to resolve the issues outstanding, the Project Mediator may terminate the negotiations by providing the parties with a written notice of termination, stating therein the Project Mediator's reasons for the termination, and the effective date of termination.

- 3) If a dispute has not been resolved within 10 working days or such other longer period as may have been agreed to by the parties, the Project Mediator shall terminate the mediation by giving written notice to the parties stating the effective date of termination.

**GC8.8.11 Costs**

- 1) The parties agree that they will each be responsible for the costs of their own representatives and advisors and associated travel and living expenses. Fees and expenses of the Project Mediator and all administrative costs of mediation, such as the cost of the meeting room(s), if any, shall be borne equally by the parties.

**GC8.8.12 Subsequent Proceedings**

- 1) The parties shall not rely on or introduce as evidence in any arbitral or judicial proceeding, whether or not such proceeding relates to the subject matter of mediation,
  - (a) any documents of other parties that are not otherwise producible in those proceedings;
  - (b) any views expressed or suggestions made by any party in respect of a possible settlement of issues;
  - (c) any admission made by any party in the course of mediation unless otherwise stipulated by the admitting party; and
  - (d) the fact that any party has indicated a willingness to make or accept a proposal or recommendation for settlement.
- 2) The Project Mediator shall neither represent nor testify on behalf of either of the parties in any subsequent investigation, action or proceeding relating to the issues in mediation proceedings.
- 3) The Project Mediator shall not be subpoenaed to give evidence relating to
  - (a) the Project Mediator's role in mediation; or
  - (b) the matters or issues in mediation;in any subsequent investigation, action or proceeding and the parties agree to vigorously oppose any effort to have the Mediator so subpoenaed.

**GC9 CONTRACT SECURITY**

GC9.1 OBLIGATION TO PROVIDE CONTRACT SECURITY

GC9.2 TYPES AND AMOUNTS OF CONTRACT SECURITY

**GC9.1 OBLIGATION TO PROVIDE CONTRACT SECURITY**

- 1) The Contractor shall, at the Contractor's expense and within 14 days after the date that the Contractor receives notice that the Contractor's bid was accepted by Canada, obtain and deliver Contract Security to Canada in one of the forms prescribed in GC9.2 TYPES AND AMOUNTS OF CONTRACT SECURITY.
- 2) If the whole or a part of the Contract Security provided is in the form of a security deposit, it shall be held and disposed of in accordance with GC5.13 RETURN OF SECURITY DEPOSIT and GC7.4 SECURITY DEPOSIT - FORFEITURE OR RETURN.
- 3) If a part of the Contract Security provided is in the form of a labour and material payment bond, the Contractor shall post a copy of that bond at the site of the Work.
- 4) It is a condition precedent to the release of the first progress payment that the Contractor has provided the Contract Security as specified herein.

**GC9.2 TYPES AND AMOUNTS OF CONTRACT SECURITY**

- 1) The Contractor shall deliver to Canada either (a) or (b).
  - (a) A performance bond and a labour and material payment bond each in an amount that is equal to not less than 50 percent of the Contract Amount.
  - (b) A security deposit or an irrevocable standby letter of credit in an amount that is equal to not less than 20 percent of the Contract Amount.
- 2) A performance bond and a labour and material payment bond referred to in paragraph 1) of GC9.2 shall be in a form and be issued by a bonding or surety company that is approved by Canada.
  - (a) The approved form for the performance bond is displayed at the following Website:  
<http://www.tbs-sct.gc.ca/pol/doc-eng.aspx?id=14494&section=text#appS>
  - (b) The approved form for the labour and material payment bond is displayed at the following website: <http://www.tbs-sct.gc.ca/pol/doc-eng.aspx?id=14494&section=text#appS>  
; and
  - (c) The list of approved bonding or surety companies is displayed at the following Website:  
<http://www.tbs-sct.gc.ca/pol/doc-eng.aspx?id=14494&section=text#appL>
- 3) A security deposit referred to in subparagraph 1)(b) of GC9.2 shall be in the form of
  - (a) a bill of exchange, bank draft or money order made payable to the Receiver General for Canada and certified by an approved financial institution or drawn by an approved financial institution on itself; or

- (b) bonds of, or unconditionally guaranteed as to principal and interest by, the Government of Canada.
- 4) For the purposes of subparagraph 3)(a) of GC9.2
- (a) a bill of exchange is an unconditional order in writing signed by the Contractor and addressed to an approved financial institution, requiring the said institution to pay, on demand, at a fixed or determinable future time a sum certain of money to, or to the order of, the Receiver General for Canada;
  - (b) if a bill of exchange, bank draft or money order is certified by or drawn on an institution or corporation other than a chartered bank, it must be accompanied by proof that the said institution or corporation meets at least one of the criteria described in subparagraph 4)(c) of GC9.2, either by letter or by a stamped certification on the bill of exchange, bank draft or money; and
  - (c) An approved financial institution is
    - (i) a corporation or institution that is a member of the Canadian Payments Association as defined in the [Canadian Payments Act](#);
    - (ii) a corporation that accepts deposits that are insured, to the maximum permitted by law, by the Canada Deposit Insurance Corporation or the "Autorité des marchés financiers";
    - (iii) a corporation that accepts deposits from the public if repayment of the deposit is guaranteed by Her Majesty the Queen in right of a province;
    - (iv) a corporation, association or federation incorporated or organized as a credit union or co-operative credit society that conforms to the requirements of a credit union which are more particularly described in paragraph 137(6) of the [Income Tax Act](#); or
    - (v) Canada Post Corporation.
- 5) Bonds referred to in subparagraph 3)(b) of GC9.2 shall be provided on the basis of their market value current at the date of the Contract, and shall be
- (a) made payable to bearer; or
  - (b) accompanied by a duly executed instrument of transfer of the bonds to the Receiver General for Canada in the form prescribed by the Domestic Bonds of Canada Regulations; or
  - (c) registered as to principal, or as to principal and interest, in the name of the Receiver General for Canada pursuant to the Domestic Bonds of Canada Regulations.
- 6) An irrevocable standby letter of credit referred to in subparagraph 1)(b) of GC9.2 shall:
- (a) be an arrangement, however named or described, whereby a financial institution (the "Issuer") acting at the request and on the instructions of a customer (the "Applicant") or on its own behalf,
    - (i) is to make a payment to, or to the order of, Canada as the beneficiary;
    - (ii) is to accept and pay bills of exchange drawn by Canada;

- (iii) authorizes another financial institution to effect such payment or accept and pay such bills of exchange; or
  - (iv) authorizes another financial institution to negotiate against written demand(s) for payment provided that the terms and conditions of the letter of credit are complied with;
- (b) state the face amount that may be drawn against it;
  - (c) state its expiry date;
  - (d) provide for sight payment to the Receiver General for Canada by way of the financial institution's draft against presentation of a written demand for payment signed by Canada;
  - (e) provide that more than one written demand for payment may be presented subject to the sum of those demands not exceeding the face value of the letter of credit;
  - (f) provide that it is subject to the International Chamber of Commerce (ICC) Uniform Customs and Practice (UCP) for Documentary Credits, 2007 Revision, ICC Publication No. 600. Pursuant to the ICC UCP, a credit is irrevocable even if there is no indication to that effect; and
  - (g) be issued or confirmed, in either official language in a format left to the discretion of the issuer or confirmer, by an approved financial institution on its letterhead.



**GC10 INSURANCE**

GC10.1 INSURANCE CONTRACTS

GC10.2 INSURANCE PROCEEDS

**GC10.1 INSURANCE CONTRACTS**

- 1) The contractor shall, at the contractor's expense, obtain and maintain insurance contracts in respect of the work and shall provide evidence thereof to Canada in accordance with the requirements of the INSURANCE TERMS.
- 2) The insurance contracts referred to in paragraph 1) of GC10.1 shall
  - (a) be in a form, of the nature, in the amounts, for the periods and containing the terms and conditions specified in INSURANCE TERMS; and
  - (b) provide for the payment of claims under such insurance contracts in accordance with GC10.2 INSURANCE PROCEEDS.

**GC10.2 INSURANCE PROCEEDS**

- 1) In the case of a claim payable under a Builders Risk/Installation (All Risks) insurance contract maintained by the contractor pursuant to GC10.1 INSURANCE CONTRACTS, the proceeds of the claim shall be paid directly to Canada, and
  - (a) the monies so paid shall be held by Canada for the purposes of the contract, or
  - (b) if Canada elects, shall be retained by Canada, in which event they vest in Canada absolutely.
- 2) In the case of a claim payable under a General Liability insurance contract maintained by the contractor pursuant to GC10.1 INSURANCE CONTRACTS, the proceeds of the claim shall be paid by the insurer directly to the claimant.
- 3) If an election is made pursuant to paragraph 1) of GC10.2, Canada may cause an audit to be made of the accounts of the contractor and of Canada in respect of the part of the work that was lost, damaged or destroyed for the purpose of establishing the difference, if any, between
  - (a) the aggregate of the amount of the loss or damage suffered or sustained by Canada, including any costs incurred in respect of the clearing and cleaning of the work and its site and any other amount that is payable by the contractor to Canada under the contract, minus any monies retained pursuant to subparagraph 1)(b) of GC10.2; and
  - (b) the aggregate of the amounts payable by Canada to the contractor pursuant to the contract up to the date of the loss or damage.
- 4) A difference that is established pursuant to paragraph 3) of GC10.2 shall be paid forthwith by the party who is determined by the audit to be the debtor to the party who is determined by the audit to be the creditor.

- 5) When payment of a deficiency has been made pursuant to paragraph 4) of GC10.2, all rights and obligations of Canada and the contractor under the contract shall, with respect only to the part of the work that was the subject of the audit referred to in paragraph 3) of GC10.2, be deemed to have been expended and discharged.
- 6) If an election is not made pursuant to subparagraph 1)(b) of GC10.2, the contractor shall, subject to paragraph 7) of GC10.2, clear and clean the work and its site and restore and replace the part of the work that was lost, damaged or destroyed at the contractor's expense as if that part of the work had not yet been performed.
- 7) When the contractor clears and cleans the work and its site and restores and replaces the work referred to in paragraph 6) of GC10.2, Canada shall pay the contractor out of the monies referred to in paragraph 1) of GC10.2 so far as they will thereunto extend.
- 8) Subject to paragraph 7) of GC10.2, payment by Canada pursuant to paragraph 7) of GC10.2 shall be made in accordance with the contract but the amount of each payment shall be 100 percent of the amount claimed notwithstanding subparagraphs 3)(a) and 3)(b) of GC5.4 PROGRESS PAYMENT.



## Appendix "E"

### TECHNICAL SPECIFICATIONS & PLANS

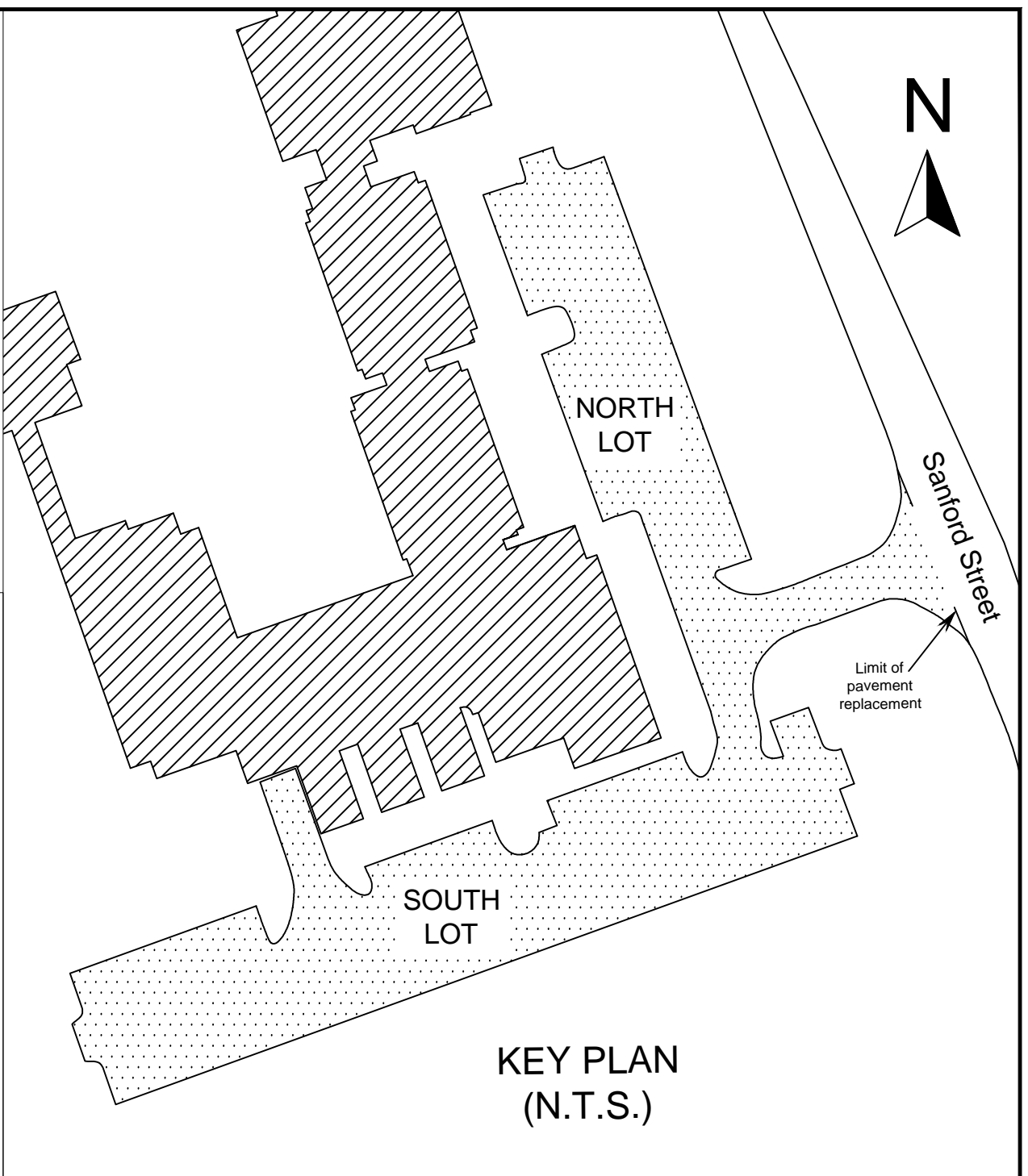
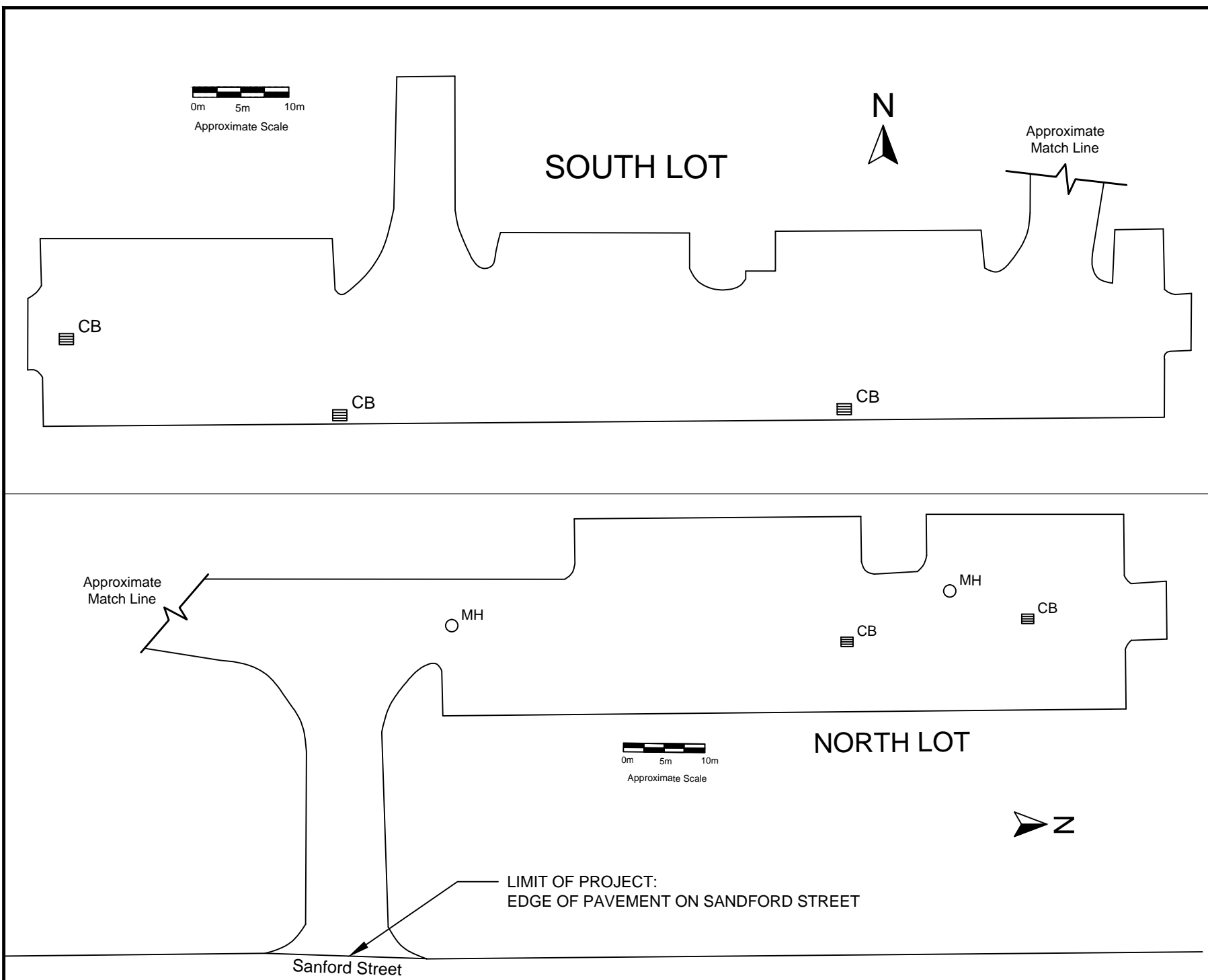

**NOTES**

1. REMOVE AND DISPOSE ALL EXISTING ASPHALT PAVEMENT IN NORTH AND SOUTH LOTS
2. EXISTING CURBS, CATCH BASINS, AND MANHOLES TO REMAIN

<b>exp Services Inc.</b> t: +1.519.963.3000 f: +1.519.963.1152 15701 Robin's Hill Road London, ON N5V 0A5 Canada  www.exp.com		<b>CLIENT</b>  AAFC/SCPFRC - LONDON 1391 SANDFORD STREET, LONDON, ON, N6A 1A8	
• BUILDINGS • ENERGY • EARTH & ENVIRONMENT • • INFRASTRUCTURE • SUSTAINABILITY •		<b>PROJECT</b>  1391 SANDFORD STREET ASPHALT REPLACEMENT	
THIS DRAWING IS THE PROPERTY OF EXP SERVICES INC. ANY REPRODUCTION BY ANY MEANS IS STRICTLY PROHIBITED WITHOUT THE WRITTEN CONSENT OF EXP SERVICES INC. THIS DRAWING AND DESIGN INTENT IS FOR THIS PROJECT ONLY.		<b>TITLE</b>  DEMOLITION	
DESIGN	B.W.	PROJECT NO.	
DRAWN BY	M.J.S.	LON-0013881-BS	
CHECKED	B.W.	DRAWING NO.	
DATE	JUNE '15	<b>1.0</b>	
SCALE	N.T.S.		

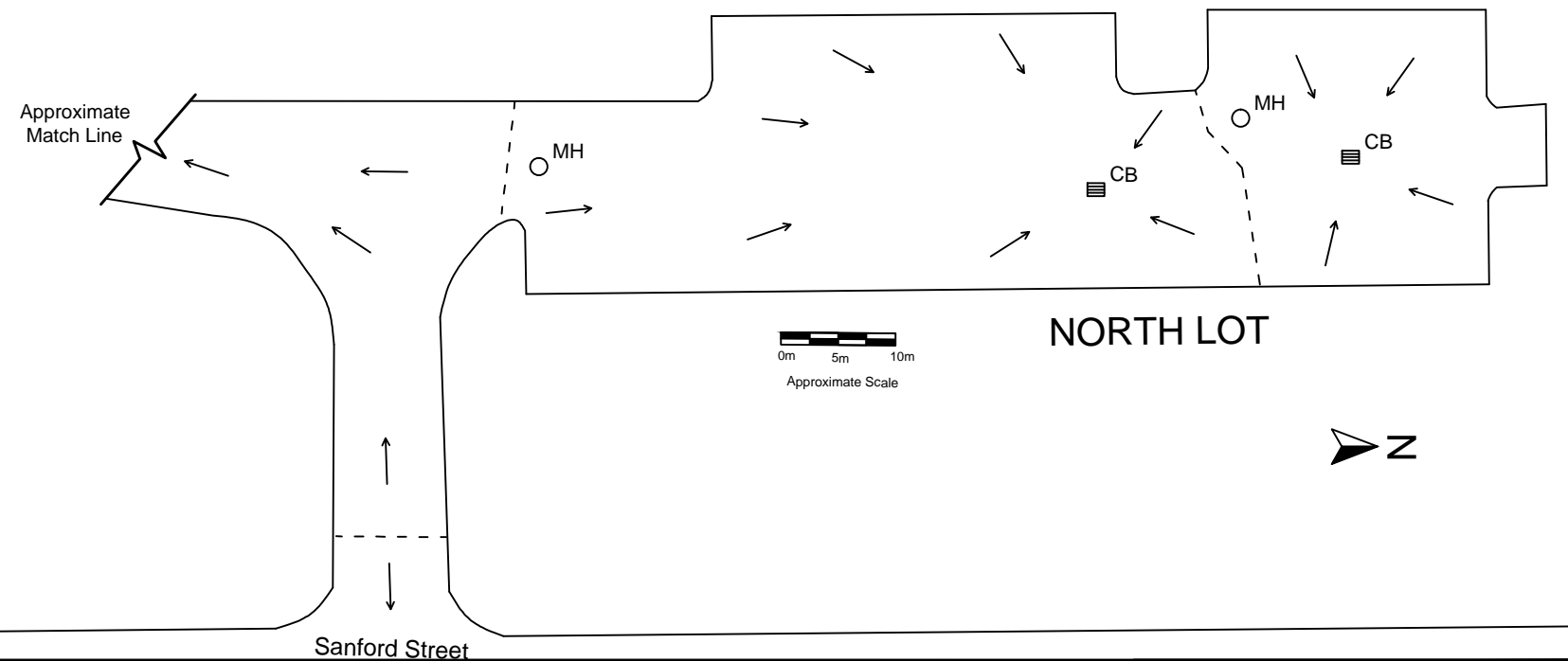
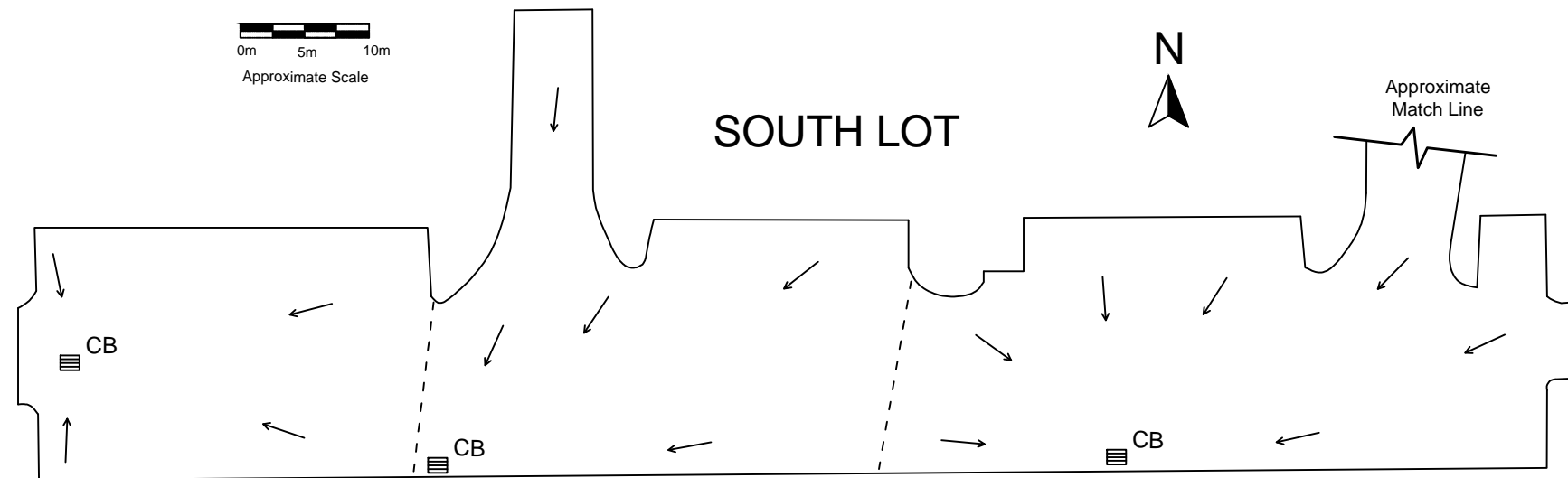

NOTES

----- APPROXIMATE LOCATION OF SLOPE CREST

exp Services Inc.  
 t: +1.519.963.3000  
 f: +1.519.963.1152  
 15701 Robin's Hill Road  
 London, ON N5V 0A5  
 Canada  
 www.exp.com



- BUILDINGS • ENERGY • EARTH & ENVIRONMENT •
- INFRASTRUCTURE • SUSTAINABILITY •

THIS DRAWING IS THE PROPERTY OF EXP SERVICES INC. ANY REPRODUCTION BY ANY MEANS IS STRICTLY PROHIBITED WITHOUT THE WRITTEN CONSENT OF EXP SERVICES INC. THIS DRAWING AND DESIGN INTENT IS FOR THIS PROJECT ONLY.

CLIENT  
 AAFC/SCPFRC - LONDON  
 1391 SANDFORD STREET, LONDON, ON, N6A 1A8

PROJECT  
 1391 SANDFORD STREET  
 ASPHALT REPLACEMENT

TITLE  
 FINISHED DRAINAGE PATTERN

DESIGN	B.W.	PROJECT NO.
DRAWN BY	M.J.S.	LON-00013881-BS
CHECKED	B.W.	DRAWING NO.
DATE	JUNE '15	2.0
SCALE	N.T.S.	

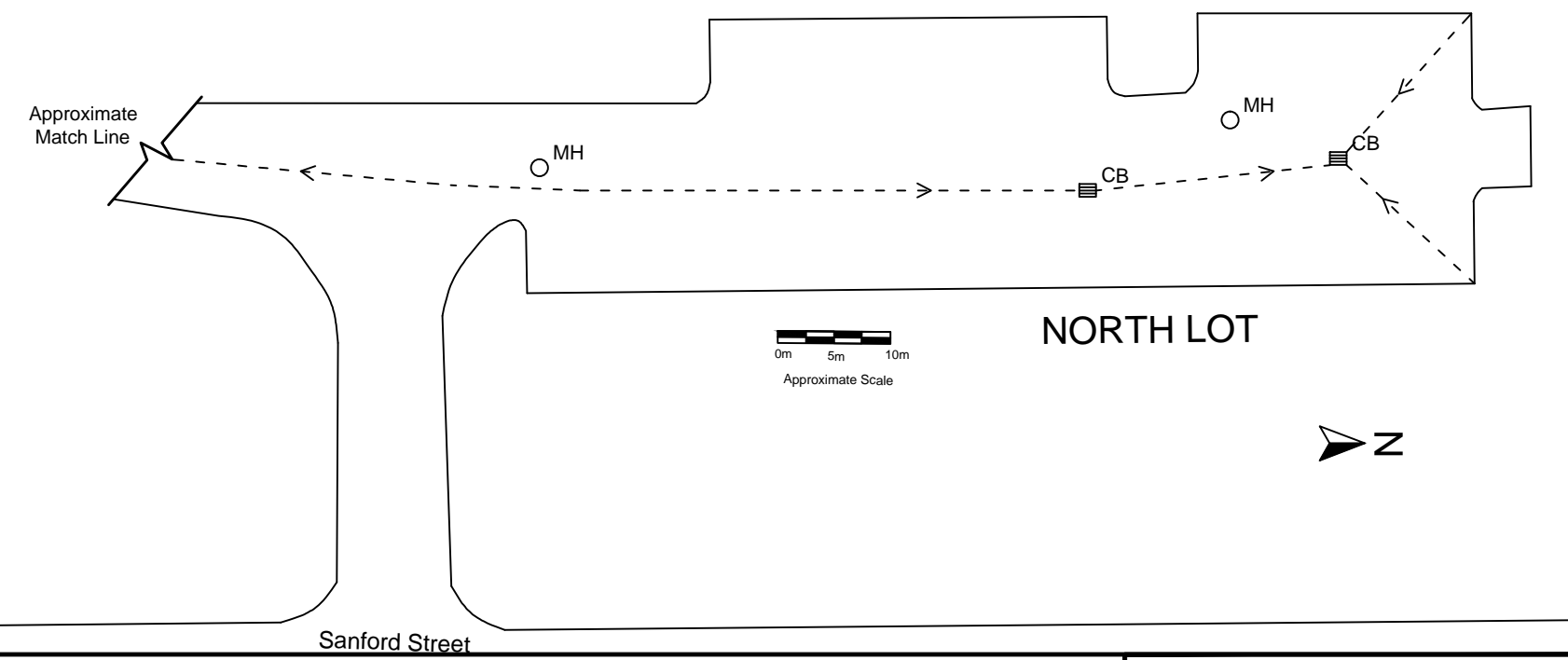
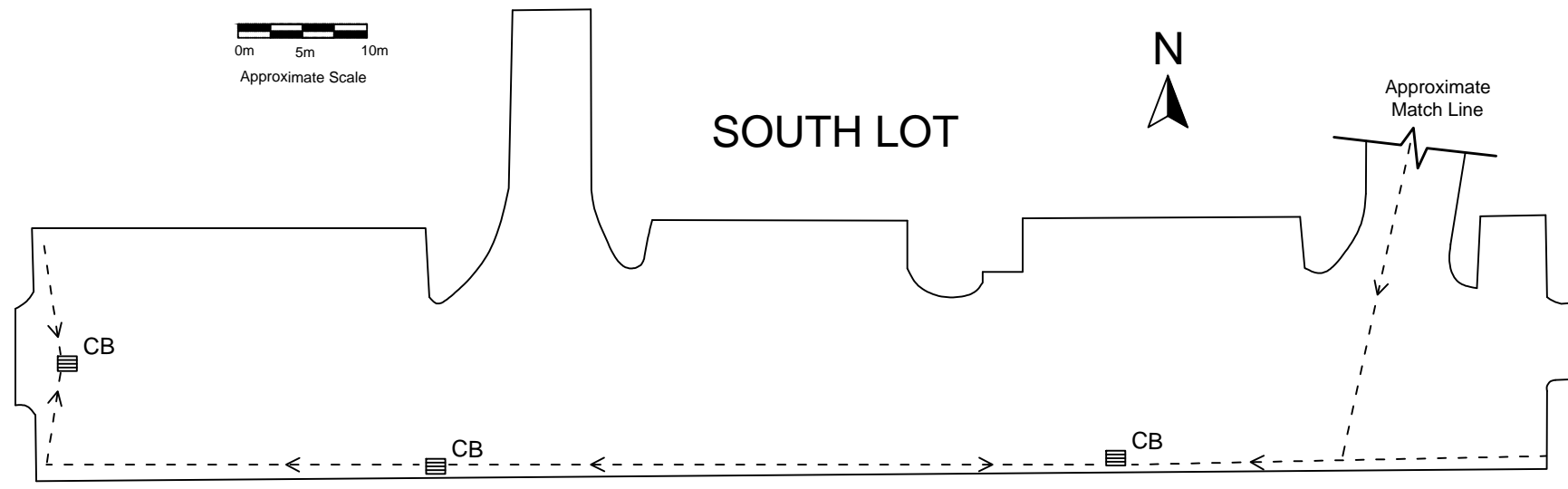

NOTES

exp Services Inc.  
 t: +1.519.963.3000  
 f: +1.519.963.1152  
 15701 Robin's Hill Road  
 London, ON N5V 0A5  
 Canada  
 www.exp.com



• BUILDINGS • ENERGY • EARTH & ENVIRONMENT •  
 • INFRASTRUCTURE • SUSTAINABILITY •

THIS DRAWING IS THE PROPERTY OF EXP SERVICES INC. ANY REPRODUCTION BY ANY MEANS IS STRICTLY PROHIBITED WITHOUT THE WRITTEN CONSENT OF EXP SERVICES INC. THIS DRAWING AND DESIGN INTENT IS FOR THIS PROJECT ONLY.

CLIENT  
 AAFC/SCPFRC - LONDON  
 1391 SANDFORD STREET, LONDON, ON, N6A 1A8

PROJECT  
 1391 SANDFORD STREET  
 ASPHALT REPLACEMENT

TITLE  
 SUBDRAIN PLAN

DESIGN	B.W.	PROJECT NO. LON-0013881-BS
DRAWN BY	M.J.S.	
CHECKED	B.W.	DRAWING NO. <b>3.0</b>
DATE	JUNE '15	
SCALE	N.T.S.	

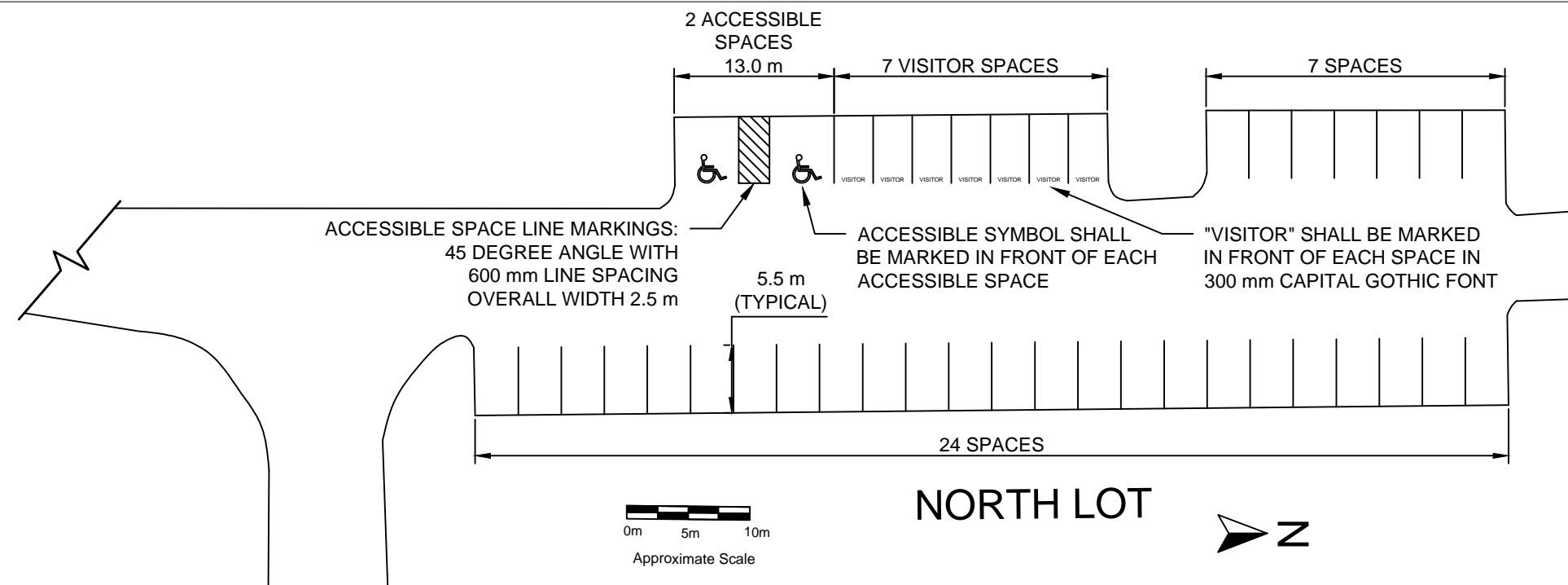
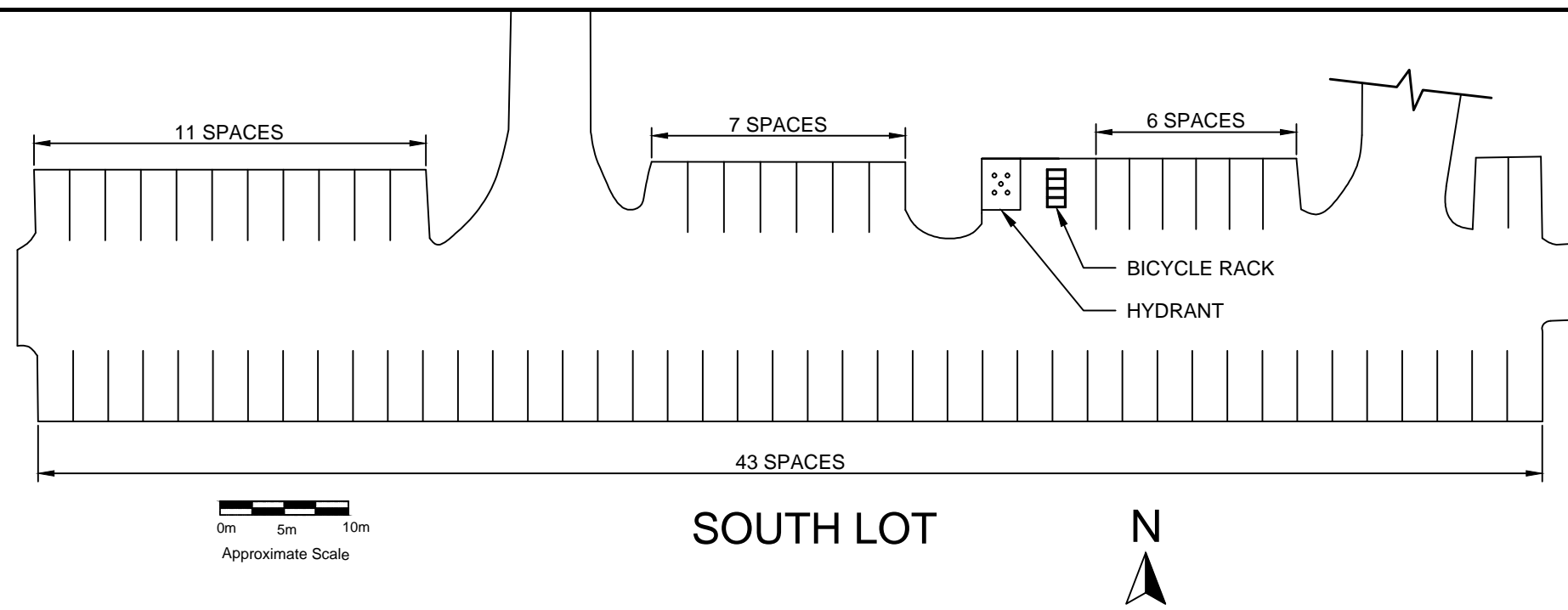

NOTES

exp Services Inc.  
t: +1.519.963.3000  
f: +1.519.963.1152  
15701 Robin's Hill Road  
London, ON N5V 0A5  
Canada  
  
www.exp.com



CLIENT  
AAFC/SCPFRC - LONDON  
1391 SANDFORD STREET, LONDON, ON, N6A 1A8

PROJECT  
1391 SANDFORD STREET  
ASPHALT REPLACEMENT

- BUILDINGS • ENERGY • EARTH & ENVIRONMENT •
- INFRASTRUCTURE • SUSTAINABILITY •

TITLE  
PAVEMENT MARKINGS

THIS DRAWING IS THE PROPERTY OF EXP SERVICES INC. ANY REPRODUCTION BY ANY MEANS IS STRICTLY PROHIBITED WITHOUT THE WRITTEN CONSENT OF EXP SERVICES INC. THIS DRAWING AND DESIGN INTENT IS FOR THIS PROJECT ONLY.

DESIGN	B.W.	PROJECT NO. LON-00013881-BS
DRAWN BY	M.J.S.	
CHECKED	B.W.	DRAWING NO. <b>4.0</b>
DATE	JUNE '15	
SCALE	N.T.S.	

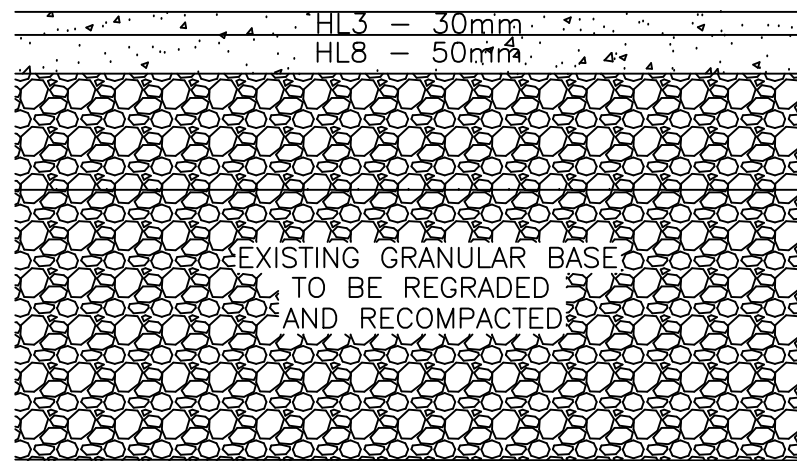

NEW PAVEMENT SECTION  
N.T.S.

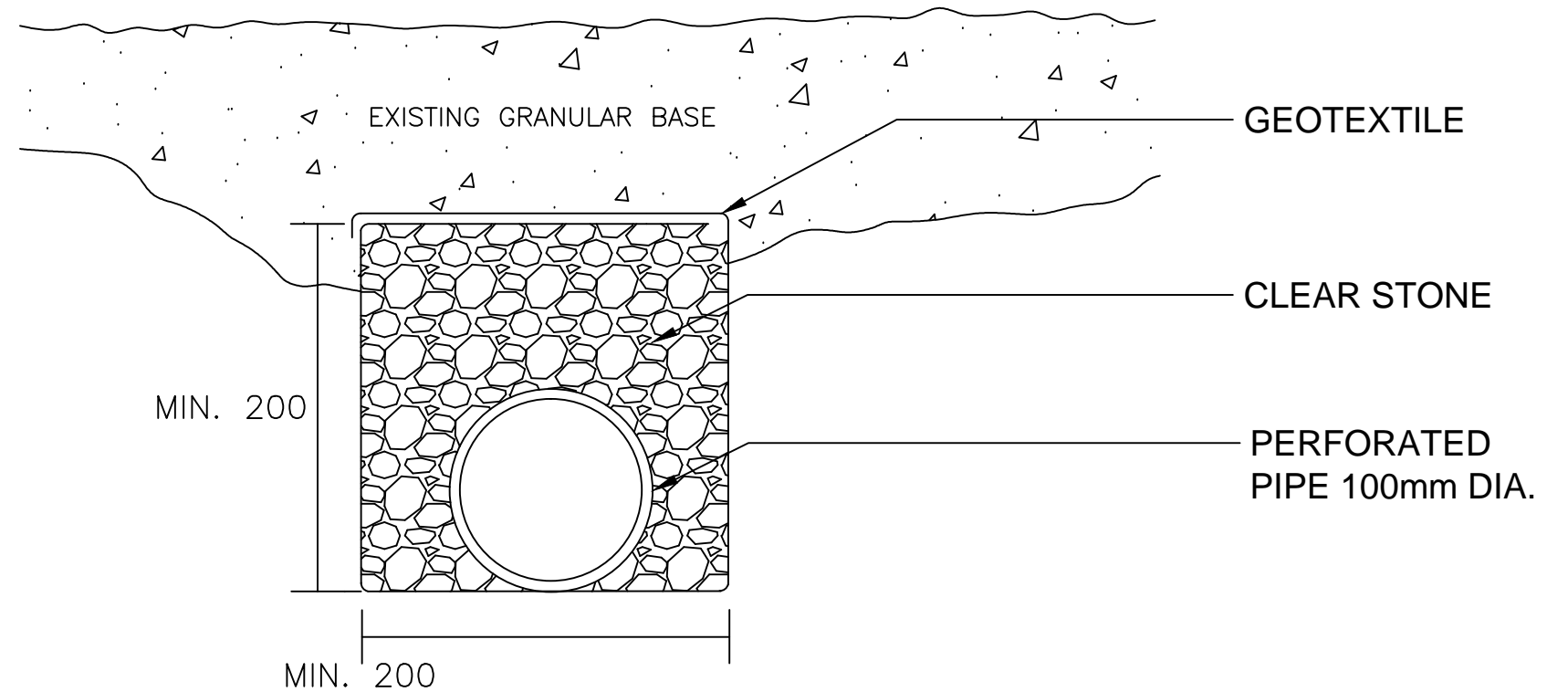

SUBSURFACE DRAIN DETAIL  
N.T.S.

NOTES

- EXISTING GRANULAR BASE TO BE REGRADED AND RECOMPACTED

exp Services Inc.  
t: +1.519.963.3000  
f: +1.519.963.1152  
15701 Robin's Hill Road  
London, ON N5V 0A5  
Canada  
  
www.exp.com



- BUILDINGS • ENERGY • EARTH & ENVIRONMENT • INFRASTRUCTURE • SUSTAINABILITY

THIS DRAWING IS THE PROPERTY OF EXP SERVICES INC. ANY REPRODUCTION BY ANY MEANS IS STRICTLY PROHIBITED WITHOUT THE WRITTEN CONSENT OF EXP SERVICES INC. THIS DRAWING AND DESIGN INTENT IS FOR THIS PROJECT ONLY.

CLIENT  
AAFC/SCPFRC - LONDON  
1391 SANDFORD STREET, LONDON, ON, N6A 1A8

PROJECT  
1391 SANDFORD STREET  
ASPHALT REPLACEMENT

TITLE  
SECTIONS

DESIGN	B.W.	PROJECT NO. LON-00013881-BS
DRAWN BY	M.J.S.	
CHECKED	B.W.	DRAWING NO. <b>5.0</b>
DATE	JUNE '15	
SCALE	N.T.S.	



## **Part 1 - General**

### **1.1 SCOPE of WORK**

- .1 Supply all labour, materials and equipment necessary to perform the selective demolition, removal and disposal of existing asphalt pavement in the North and South Parking Lots specified on attached Drawings, to the full extent of the Specifications.
- .2 Dispose of demolished materials except where noted otherwise. Disposal and transportation of any waste material off site should conform to requirements of Ontario MOE and Ontario EPA.
- .3 Identification of utilities.

### **1.2 CLOSEOUT SUBMITTALS**

- .1 Record Documentation: Accurately record actual locations of subsurface obstructions and deleterious subgrade materials.

### **1.3 REGULATORY REQUIREMENTS**

- .1 Conform to applicable code for demolition work. (e.g. dust control)
- .2 Obtain required permits from authorities.
- .3 Do not close or obstruct egress width to any building or site exit. Site must remain accessible to firefighting apparatus.
- .4 Conform to applicable regulatory procedures when discovering hazardous or contaminated materials.
- .5 All work shall conform to City of London noise by-laws

### **1.4 PROJECT CONDITIONS**

- .1 Conduct demolition to minimize interference with adjacent, occupied building areas.
- .2 Take measures to control dust.

## **Part 2 - Products**

### **2.1 MATERIALS**

- .1 Anticipated materials to be disposed of consist of asphalt paving and granular base.

## **Part 3 - Execution**

### **3.1 PREPARATION**

- .1 Provide barricades, guard rails, fencing, and other protection as required, to give protection to occupants, general public, and workers employed on the demolition, and to adjacent buildings, properties and landscaping.

- .2 Protect adjacent building surfaces and properties not subject to demolition against damage which might occur from falling debris or other causes related to the work. Maintain free and safe passage to and from and within the buildings.
- .3 Prevent movement, settlement or damage to adjacent structures and parts of existing building to remain. Make good damage and be liable for injury caused by demolition. Prevent movement of structures such as, but not limited to, manholes and catch basins.
- .4 Prevent debris from blocking any building, site or municipal drainage system.
- .5 Provide appropriate temporary signage including signage for exit or building egress.
- .6 Make provision for flag man where construction vehicles enter and exit construction area.

### **3.2 DEMOLITION**

- .1 Demolish in an orderly and careful manner. Protect existing curbs, catch basins, and manholes and other plant within the pavement structure. Remove demolished materials from site except where specifically noted otherwise. Remove materials as Work progresses. Upon completion of Work, leave areas in clean condition.
- .2 Take measures to control dust during disposal operations.
- .3 Articles of antiquity or value discovered during demolition work at the site shall remain property of the Owner.

**END OF SECTION 02 41 19**

## **Part 1 - General**

### **1.1 SECTION INCLUDES**

- .1 Specified Aggregate materials.

### **1.2 RELATED SECTIONS**

- .1 Section 33 46 13 – Subsurface Drainage.
- .2 Section 31 22 19 – Finish Grading

### **1.3 SUBMITTALS FOR INFORMATION**

- .1 Materials Source(s): Submit name of imported materials suppliers minimum five (5) working days prior to importing materials to Site to allow quality review of proposed materials by Consultant.
- .2 Contractor shall provide copies of load tickets for imported material delivered to the site and incorporated into the work.

## **Part 2 - Products**

### **2.1 COARSE AGGREGATE MATERIALS**

- .1 Granular 'A' fill material: as needed for on the specifications and conforming in all respects with O.P.S.S. 1010, latest edition.
- .2 Granular 'B' fill material: as needed for on the specifications and conforming in all respects with O.P.S.S. 1010, latest edition.
- .3 Clear stone, sound, nominal size 20 mm (3/4 in) or an approved equivalent.

### **2.2 SOURCE QUALITY CONTROL**

- .1 If tests indicate materials do not meet specified requirements, change material or material source and retest.
- .2 Provide materials of each type from same source throughout the Work.

## **Part 3 - Execution**

### **3.1 STOCKPILING**

- .1 Minimal space is available on site for stockpiling of granular material.
- .2 Arrange and schedule Work to incorporate delivered aggregate materials into the Work as quickly as reasonable.
- .3 Stockpile materials on site at locations designated by Consultant.

- .4 Stockpile in sufficient quantities to meet Project schedule and requirements, but not as such to significantly interfere with the daily activity of the facility or the progress of the Work.
- .5 Separate differing materials with dividers or stockpile apart to prevent mixing.
- .6 Direct surface water away from stockpile site so as to prevent erosion or deterioration of materials.

### **3.2 STOCKPILE CLEANUP**

- .1 At Project conclusion, remove unused stockpiled material, leave area in a clean and neat condition.

**END OF SECTION 31 05 16**

## **Part 1 - General**

### **1.1 SECTION INCLUDES**

- .1 Final grade granular base to accept new asphaltic pavement.
- .2 Final grading shall be carried out after placement of specified sub-drains.
- .3 Final grades shall generally match the existing grade to allow final asphalt surface to match pre-demolition grades and specified drainage pattern specified on the project drawings.
- .4 Compact graded granular surface to 100% SPMDD.

### **1.2 RELATED SECTIONS**

- .1 Section 32 12 16 - Asphalt Paving.

## **Part 2 - Products**

### **2.1 MATERIAL**

- .1 Granular 'A' as needed to achieve final grading, conforming in all respects with O.P.S.S. 1010, latest edition.

## **Part 3 - Execution**

### **3.1 EXAMINATION**

- .1 Verify existing conditions before starting work.
- .2 Verify granular base has been contoured and compacted as specified.
- .3 Consultant will carry out testing as needed to verify specified compaction has been achieved.

### **3.2 TOLERANCES**

- .1 Top of Granular: Plus or minus 20 mm (3/4 inch).

### **3.3 PROTECTION OF FINISHED WORK**

- .1 Protect landscaping and other features remaining as final work.
- .2 Protect existing structures, utilities, curbs, manholes, and catch basins.

**END OF SECTION 31 22 19**

## **Part 1 - General**

### **1.1 SECTION INCLUDES**

- .1 Excavating for installation of subsurface drains.

### **1.2 RELATED SECTIONS**

- .1 Section 33 46 13 – Subsurface Drainage.

## **Part 2 - Products**

### **2.1 NOT USED**

- .1 Not Used.

## **Part 3 - Execution**

### **3.1 EXAMINATION**

- .1 Verify existing conditions before starting work.

### **3.2 PREPARATION**

- .1 Locate, identify, and protect existing utilities to remain from damage.
- .2 Protect plant life, lawns, and other features remaining as a portion of final landscaping.
- .3 Protect bench marks, sidewalks, curbs, and other features to remain from excavating equipment and vehicular traffic.

### **3.3 EXCAVATING**

- .1 Excavate existing granular pavement base and subgrade soil to correct depth to accommodate the specified subsurface drains.
- .2 Notify Consultant of unexpected subsurface conditions and discontinue affected Work in area until notified to resume work.
- .3 Correct unauthorized excavation at no extra cost by backfilling with Granular 'B' compacted to 98% SPMDD.
- .4 Remove from Site and dispose of excess, unsuitable, deleterious, or contaminated material off site in an environmentally acceptable manner by recycling and/or transportation to an approved landfill.
- .5 Excavation beyond that specified, if authorized in writing by the Consultant, must be pre-approved by in writing by AAFC/SCPFRC.

### **3.4 FIELD QUALITY CONTROL**

- .1 Exposed subsurface drain trench to be examined and approved by Consultant before placing filter cloth, pipe and aggregate.

### **3.5 PROTECTION OF FINISHED WORK**

- .1 Protecting existing curbs, catch basins and any other items specified to remain.

**END OF SECTION 31 23 16**

## **Part 1 - General**

### **1.1 SCOPE of WORK**

- .1 Supply, place and compact Asphaltic concrete paving, wearing and binder course as specified.

### **1.2 RELATED SECTIONS**

- .1 Section 32 17 24 - Pavement markings.

### **1.3 REFERENCES**

- .1 Asphaltic concrete pavement to conform to latest OPSS Standards.
- .2 Tack Coat: Emulsified asphalt conforming to latest OPSS Standards.

### **1.4 PERFORMANCE REQUIREMENTS**

- .1 Paving: Designed for light duty commercial vehicles and automotive parking.

### **1.5 SUBMITTALS FOR INFORMATION**

- .1 Upon request, provide asphalt supplier's mix designs for HL8 and HL3.

### **1.6 SUBMITTALS**

- .1 Provide copies of Load Tickets for asphalt supplied to the site and incorporated into the work.

### **1.7 QUALITY ASSURANCE**

- .1 Perform Work to OPSS 310, latest edition.
- .2 Obtain materials from same source throughout.

### **1.8 ENVIRONMENTAL REQUIREMENTS**

- .1 Do not place asphalt when ambient air or base surface temperature is less than 4 degrees C (40 degrees F), or surface is wet or frozen.
- .2 Asphaltic concrete temperature at placement to be 135-160C with air temperature below 5C and 115- 145C with air temperature above 15C.

## **Part 2 - Products**

### **2.1 MATERIALS**

- .1 Tack Coat: Emulsified asphalt conforming to latest OPSS Standards.

### **2.2 ASPHALT PAVING MIX**

- .1 Binder Course: HL8, conforming to OPSS 1150, latest edition.
- .2 Wearing Course: HL3, conforming to OPSS 1150, latest edition.



### **Part 3 - Execution**

#### **3.1 EXAMINATION**

- .1 Verify existing conditions before starting work.
- .2 Verify that compacted granular base is dry and ready to support paving and imposed loads.
- .3 Verify gradients and elevations of base are correct.

#### **3.2 PREPARATION – TACK COAT**

- .1 Apply tack coat to manufacturer's written instructions.
- .2 Apply tack coat to contact surfaces of curbs, gutters.
- .3 Coat surfaces of catch basin and manhole frames with oil to prevent bond with asphalt pavement. Do not tack coat these surfaces.

#### **3.3 PLACING ASPHALT PAVEMENT**

- .1 Place asphalt binder course (HL8) within twenty-four (24) hours of applying primer or tack coat.
- .2 Place binder course (HL8) to 50 mm compacted thickness.
- .3 Compact pavement by rolling to a minimum density of 97% Marshall Density. Do not displace or extrude pavement from position. Hand compact in areas inaccessible to rolling equipment.
- .4 Place wearing course (HL3) to 30 mm compacted thickness.
- .5 Compact pavement by rolling to a minimum density of 97% Marshall Density. Do not displace or extrude pavement from position. Hand compact in areas inaccessible to rolling equipment.
- .6 Perform rolling with consecutive passes to achieve even and smooth finish, without roller marks.
- .7 Compacted surface course to be clean and free from fractures, spalling or other defects.
- .8 Keep traffic off newly paved areas until pavement surface temperature has cooled below 35C.

#### **3.4 TOLERANCES**

- .1 Flatness: Maximum variation of 10 mm measured with 3 m straight edge.
- .2 Scheduled Compacted Thickness: Within 6 mm.
- .3 Variation from True Elevation: Within 13 mm.

#### **3.5 FIELD QUALITY CONTROL**

- .1 Consultant will take samples and perform tests to confirm specification has been met.

### **3.6 PROTECTION OF FINISHED WORK**

- .1 Keep traffic off newly paved areas until pavement surface temperature has cooled below 35 C.

**END OF SECTION 32 12 16**

## **Part 1 - General**

### **1.1 SECTION INCLUDES**

- .1 Painted pavement markings.

### **1.2 REFERENCES**

- .1 AASHTO M 248-91 (2012) - Standard Specification for Ready-Mixed Yellow Traffic Paints.
- .2 All marking shall adhere to Federal Identity Program by Treasury Board of Canada.

### **1.3 ADMINISTRATIVE REQUIREMENTS**

- .1 Coordination:
  - .1 Coordinate with other work having a direct bearing on work of this section.

### **1.4 QUALITY ASSURANCE**

- .1 Manufacturer Qualifications: Company specializing in manufacturing the Products specified in this section with minimum three (3) years documented experience.
- .2 Applicator Qualifications: Company specializing in performing the work of this section with minimum three (3) years documented experience.

### **1.5 ENVIRONMENTAL REQUIREMENTS**

- .1 Apply paint only when ambient temperature is above 10 degrees C (50 degrees F) and no rain is forecast, unless approved otherwise by Consultant.

## **Part 2 - Products**

### **2.1 MATERIALS**

- .1 Paint: Alkyd or latex traffic paint, specifically formulated for asphalt pavement marking.
  - .1 Colours: Yellow for lines and hatching, Blue for accessible space symbol.
- .2 Thinner: Approved as compatible with paint by paint manufacturer.

### **2.2 EQUIPMENT REQUIREMENTS**

- .1 Paint Applicator:
  - .1 Pressure distributor.
  - .2 Capable of applying paint in single and dashed lines.
  - .3 Ensure uniform application.
  - .4 Equip with positive shut-off.

### **Part 3 - Execution**

#### **3.1 PREPARATION**

- .1 Assure pavement surface free of surface water, snow, frost, ice, dust, oil, and other foreign materials.
- .2 Provide adequate warning signs, barriers, and traffic devices to prevent fresh-paint tracking by traffic.

#### **3.2 APPLICATION**

- .1 Lay out pavement markings prior to applying paint, to approval of Consultant.
- .2 Marking paint shall be applied no sooner than one (1) day after completion of the placement of asphalt pavement.
- .3 Apply paint evenly at rate specified by the paint manufacturer. Do not thin paint unless approved by Consultant.
- .4 Apply yellow marking paint delineating parking spaces as shown on the attached drawing(s). Stripes shall be 5.5 metres long, straight, and 100 mm wide. Stripes shall be a minimum of 2.75 m apart, and perpendicular to the edge of the parking area. The accessible spaces shall be a minimum of 5.25 m in width.
- .5 Symbols denoting the accessible spaces shall be applied with blue marking paint, as shown on the attached Drawing No. 5, with minimum vertical and horizontal dimensions of 800 mm and 600 mm respectively.
- .6 Symbols denoting the visitor spaces shall be applied with yellow marking paint, as shown on the attached Drawing No. 5, in Gothic capitals with a height of 300mm.
- .7 Adjustment of the spacing is permitted to allow uniform spacing of the stripes.
- .8 Symbols and letters to conform to dimensions indicated.
- .9 Paint lines of uniform colour and density with clean edges.
- .10 Thoroughly clean distributor tank before refilling with paint of different colour.

#### **3.3 TOLERANCES**

- .1 Painted Markings:
  - .1 Maximum Variation from Required Line Width Dimensions: Plus or minus 6 mm.
  - .2 Maximum Variation from Required Length Dimensions: Plus or minus 20 mm.
- .2 Remove Incorrect Markings.

#### **3.4 PROTECTION OF FINISHED WORK**

- .1 Protect pavement markings from any disfigurement, until dry.

**END OF SECTION 32 17 24**

## **Part 1 - General**

### **1.1 SCOPE of WORK**

- .1 Supply and install sub-surface drainage system as specified on the attached drawings and specifications. Includes hand trimming, excavating, bedding, pipe and fittings, filter fabric, filter aggregate, and connecting to catch basin(s).
- .2 Filter aggregate, fabric, and bedding.

### **1.2 RELATED SECTIONS**

- .1 Section 31 05 16 - Aggregate Materials.
- .2 Section 31 23 16 - Excavating: Excavating for site sub-surface drainage system piping and surrounding filter aggregate.

## **Part 2 - Products**

### **2.1 PIPE MATERIALS**

- .1 PVC or ABS Pipe: perforated, 4 inch inside diameter; with required fittings.

### **2.2 AGGREGATE AND BEDDING**

- .1 Filter Aggregate Materials: Clear  $\frac{3}{4}$  inch stone.

### **2.3 ACCESSORIES**

- .1 Pipe Coupling: Compatible with pipe material.
- .2 Filter Fabric: Water pervious type, black, nonwoven.
  - .1 Product: Terrafix 270R or an approved equivalent.

## **Part 3 - Execution**

### **3.1 EXAMINATION**

- .1 Verify existing conditions before starting work.
- .2 Inform Consultant and verify that trench cut is ready to receive filter cloth, and excavations, dimensions, and elevations are as indicated on layout Drawings.
- .3 Inform Consultant before placing filter cloth, pipe and filter aggregate.

### **3.2 PREPARATION**

- .1 Hand trim excavations to required elevations. Correct over excavation with clean sand or an approved equivalent.

- .2 Remove large stones, roots, or other hard matter which could damage drainage piping or impede operation of the sub-drain system or consistent backfilling or compaction.

### **3.3 INSTALLATION**

- .1 Install filter cloth to line trench as shown on the attached Drawing(s). Minimize aggregate bed thickness under pipe so water does not collect under piping and not drain as intended.
- .2 Place drainage pipe on filter cloth.
- .3 Lay pipe to slope gradients noted on Drawing(s).
- .4 Place pipe with perforations facing down. Mechanically join pipe ends. Cap open pipe ends. Install pipe couplings if applicable.
- .5 Install filter aggregate at sides, and top of pipe as shown on the attached Drawing(s). Place filter fabric over levelled top surface of aggregate cover prior to subsequent backfilling operations.
- .6 Do not displace or damage pipe when compacting pavement structure fill materials above the sub-drains.
- .7 Connect sub-drain pipe(s) to catch basin(s).

### **3.4 FIELD QUALITY CONTROL**

- .1 Advise Consultant at least two (2) days prior to commencement of installation.

### **3.5 PROTECTION OF FINISHED WORK**

- .1 Protect pipe and aggregate cover from damage or displacement until backfilling operation begins.

**END OF SECTION 33 46 13**



## Appendix "F"

### INSURANCE TERMS

## INSURANCE TERMS

- IN1    GENERAL
  - IN1.1    Worker's Compensation
  - IN1.2    Indemnification
  - IN1.3    Proof of Insurance
  - IN1.4    Insured
  - IN1.5    Payment of Deductible
  
- IN2    COMMERCIAL GENERAL LIABILITY
  - IN2.1    Scope of Policy
  - IN2.2    Period of Insurance
  
- IN3    AUTOMOBILE INSURANCE
  - IN3.1    Scope of Policy
  
- IN4    BUILDER'S RISK / INSTALLATION FLOATER
  - IN4.1    Scope of Policy
  - IN4.2    Amount of Insurance
  - IN4.3    Period of Insurance
  - IN4.4    Insurance Proceeds

### **IN1    GENERAL**

#### **IN1.1    Worker's Compensation**

- 1) The Contractor shall provide and maintain Worker's Compensation Insurance in accordance with the legal requirements of the Province or Territory where the work is being carried out.

#### **IN1.2    Indemnification**

- 1) The insurance required by the provisions of these Insurance Terms shall in no way limit the Contractor's responsibility under the Indemnification clause of the General Conditions of the contract. Any additional coverage the Contractor may deem necessary to fulfill his obligations under the aforesaid clause shall be at his own discretion and expense.

#### **IN1.3    Proof of Insurance**

- 1) Before commencement of the Work, and within thirty (30) days after acceptance of its bid, the Contactor shall deposit with Canada a CERTIFICATE OF INSURANCE (form AAFC / AAC5314) available upon request.
- 2) Upon request by Canada, the Contractor shall provide originals or certified true copies of all contracts of insurance maintained by the Contractor pursuant to the provisions contained herein.

#### **IN1.4    Insured**

- 1) Each policy shall insure the Contractor and shall include Her Majesty the Queen in right of Canada, represented by the Minister of Agriculture & Agri-Food Canada as an additional Insured, with respect to liability arising out of the operations of the contractor with regard to the work.



## **INSURANCE TERMS (Continued)**

### **IN1.5 Payment of Deductible**

- 1) The payment of monies up to the deductible amount made in satisfaction of a claim shall be borne by the Contractor.

## **IN2 COMMERCIAL GENERAL LIABILITY**

### **IN2.1 Scope of Policy**

- 1) The insurance coverage provided shall not be less than that provided by IBC Form 2100, as amended from time to time, and shall have:
  - (a) an Each Occurrence Limit of not less than \$5,000,000.00 ;
  - (b) a Products/Completed Operations Aggregate Limit of not less than \$5,000,000.00 ; and
  - (c) a General Aggregate Limit of not less than \$10,000,000.00 per policy year, if the policy is subject to such a limit.
- 2) The policy shall either include or be endorsed to include coverage for the following exposures or hazards if the Work is subject thereto:
  - (a) Blasting.
  - (b) Pile driving and caisson work.
  - (c) Underpinning.
  - (d) Removal or weakening of support of any building or land whether such support be natural or otherwise if the work is performed by the insured contractor.
  - (e) Asbestos.
  - (f) Non-owed Automobile Policy.

### **IN2.2 Period of Insurance**

- 1) Unless otherwise directed in writing by Canada, or, otherwise stipulated elsewhere herein, the policy required herein shall be in force and be maintained from the date of contract award until the day of issue of the Certificate of Completion except that the coverage for Completed Operations Liability shall, in any event, be maintained for a period of at least six (6) years beyond the date of the CERTIFICATE OF SUBSTANTIAL PERFORMANCE.

## **IN3 AUTOMOBILE INSURANCE**

### **IN3.1 Scope of Policy**

- 1) Automobile Liability Insurance in respect of licensed vehicles shall have limits of not less than one million dollars inclusive per occurrence for bodily injury, death, and damage to property.

## **INSURANCE TERMS (Continued)**

### **IN4 BUILDER'S RISK / INSTALLATION FLOATER**

#### **IN4.1 Scope of Policy**

- 1) The insurance coverage provided by a Builder's Risk policy or an Installation Floater policy shall not be less than that provided by IBC Forms 4042 and 4047, as amended from time to time.
- 2) The policy shall permit use and occupancy of the project, or any part thereof, where such use and occupancy is for the purposes for which the project is intended upon completion.
- 3) The policy may exclude or be endorsed to exclude coverage for loss or damage caused by any of the following:
  - (a) Asbestos.
  - (b) Fungi or spores.
  - (c) Cyber.
  - (d) Terrorism.

#### **IN4.2 Amount of Insurance**

- 1) The amount of insurance shall not be less than the sum of the contract value plus the declared value (if any) set forth in the contract documents of all material and equipment supplied by Canada at the site of the project to be incorporated into and form part of the finished Work. If the value of the Work is changed, the policy shall be changed to reflect the revised contract value.

#### **IN4.3 Period of Insurance**

- 1) Unless otherwise directed in writing by Canada, or, stipulated elsewhere herein, the policy required herein shall be in force and be maintained from prior to the commencement of work until the day of issue of the CERTIFICATE OF SUBSTANTIAL PERFORMANCE.

#### **IN4.4 Insurance Proceeds**

- 1) The policy shall provide that the proceeds thereof are payable to Her Majesty or as Canada may direct in accordance with GC 10.2 Insurance Proceeds.
- 2) The Contractor shall, without delay, do such things and execute such documents as are necessary to effect payment of the proceeds.



## Appendix "G"

### CONTRACT DOCUMENTS

## MAJOR WORKS - CONTRACT DOCUMENTS

### SC01 CONTRACT DOCUMENTS

- 1) The following are the contract documents:
  - (a) Contract page when signed by Canada;
  - (b) Duly completed Bid and Acceptance Form and any Appendices attached thereto;
  - (c) Drawings and Specifications;
  - (d) AAFC General Conditions form AAFC / AAC5321-E:
    - (i) GC1 General Provisions
    - (ii) GC2 Administration of the Contract
    - (iii) GC3 Execution and Control of the Work
    - (iv) GC4 Protective Measures
    - (v) GC5 Terms of Payment
    - (vi) GC6 Delays and Changes in the Work
    - (vii) GC7 Default, Suspension or Termination of Contract
    - (viii) GC8 Dispute Resolution
    - (ix) GC9 Contract Security
    - (x) GC10 Insurance
  - (e) Supplementary Conditions, if any;
  - (f) Insurance Terms form AAFC / AAC5315-E;
  - (g) Any amendment issued or any allowable bid revision received before the date and time set for solicitation closing;
  - (h) Any amendment incorporated by mutual agreement between Canada and the Contractor before acceptance of the bid; and
  - (i) Any amendment or variation of the contract documents that is made in accordance with the General Conditions.
- 2) The language of the contract documents shall be the language of the Bid and Acceptance Form submitted.

### SC02 ACCEPTANCE AND CONTRACT

- 1) Upon acceptance of the Contractor's offer by Canada, a binding Contract shall be formed between Canada and the Contractor. The documents forming the Contract shall be the contract documents referred to in SC01 CONTRACT DOCUMENTS.



## Appendix "H"

## CONTRACT

## CONTRACT

### PURCHASING OFFICE

Agriculture and Agri-Food Canada  
 Eastern Service Centre  
 Tender Receiving Unit  
 2001 University Street., Suite 671-TEN  
 Montréal, Quebec  
 H3A 3N2

**Your tender is accepted** to sell to Her Majesty the Queen in right of Canada, in accordance with the terms and conditions set out herein, referred to herein or attached hereto, the construction listed herein and on any attached sheets at the price or prices set out therefor.

Comments
----------

Vendor / Firm Name and Address
--------------------------------

Title		
Solicitation / Contract No.		Date
Client Reference No.		
File No.		
Financial Code(s)		<input type="radio"/> GST <input type="radio"/> HST <input type="radio"/> QST
F.O.B Destination		
Applicable Taxes Included		
Destination		
Invoices - Original and two copies to be sent to :		
Address Enquiries to:		
Telephone No.	Ext.	Fax No.
Total Estimated Cost		Currency Type CAD
For the Minister		
Signature _____		Date _____



## FORMS

- Bid Bond
- Certificate of Insurance
- Labour and Material Payment Bond
- Performance Bond
- T4-A Certification

## BID BOND

**BOND NUMBER:** \_\_\_\_\_

**AMOUNT:** \_\_\_\_\_

KNOW ALL PERSONS BY THESE PRESENTS, that \_\_\_\_\_ as Principal,  
hereinafter called the Principal, and \_\_\_\_\_ as Surety,

hereinafter called the Surety, are, subject to the conditions hereinafter contained, held and firmly bound unto Her Majesty the Queen in right of Canada as represented by the Minister of Agriculture and Agri-Food, as Oblige, hereinafter called the Crown, in the amount of

\_\_\_\_\_ dollars (\$ \_\_\_\_\_), lawful money of Canada, for the payment of which sum, well and truly to be made, the Principal and the Surety bind themselves, their heirs, executors, administrators, successors and assigns, jointly and severally, firmly by these presents.

SIGNED AND SEALED this \_\_\_\_\_ day of \_\_\_\_\_, 20\_\_.

WHEREAS, the Principal has submitted a written tender to the Crown, dated the \_\_\_\_\_ day of \_\_\_\_\_, 20\_\_,

for \_\_\_\_\_

NOW, THEREFORE, THE CONDITIONS OF THIS OBLIGATION are such that if:

- (a) the Principal, should his tender be accepted within the period specified by the Crown, or, if no period be specified, within sixty (60) days after closing date of the tender, does execute within a period specified by the Crown, or, if no period be specified therein, within fourteen (14) days after the prescribed forms are presented to him for signature, execute such further contractual documents, if any, as may be required by the terms of the tender as accepted, and does furnish a Performance Bond and a Labour and Material Payment Bond, each in the amount of 50% of the Contract price and satisfactory to the Crown, or other security acceptable to the Crown, or
- (b) the Principal does pay to the Crown the difference between the amount of the Principal's tender and the amount of the Contract entered into by the Crown for the work, supplies and services which were specified in the said tender, if the latter amount be in excess of the former,

then this obligation shall be void; otherwise it shall remain in full force and effect.

PROVIDED, HOWEVER, that the Surety and the Principal shall not be liable to the Crown for an amount greater than the amount specified in this bond.

PROVIDED FURTHER that the Surety shall not be subject to any suit or action unless such suit or action is instituted and process therefore served upon the Surety at its Head Office in Canada, within twelve (12) months from the date of this bond.

IN TESTIMONY WHEREOF, the Principal has hereto set its hand and affixed its seal, and the Surety has caused these presents to be sealed with its corporate seal duly attested by the signature of its authorized signing authority, the day and year first above written.

SIGNED, SEALED AND DELIVERED in the presence of:

\_\_\_\_\_  
Principal

\_\_\_\_\_  
Witness

\_\_\_\_\_  
Surety

Note: Affix Corporate seal if applicable.



## CERTIFICATE OF INSURANCE

To be completed by the Insurer

CONTRACT					
Description and location of work					Contract No.
					Project No.
INSURER			BROKER		
Company name			Company name		
Unit/Suite/Apt.	Street number	Number suffix	Unit/Suite/Apt.	Street number	Number suffix
Street name			Street name		
Street type	Street direction	PO Box or Route Number	Street type	Street direction	PO Box or Route Number
Municipality (City, Town, etc.)			Municipality (City, Town, etc.)		
Province/State	Postal/ZIP code		Province/State	Postal/ZIP code	
INSURED			ADDITIONAL INSURED		
Contractor name			Her Majesty the Queen in right of Canada as represented by the Minister of Agriculture and Agri-Food Canada.		
Unit/Suite/Apt.	Street number	Number suffix			
Street name					
Street type	Street direction	PO Box or Route Number			
Municipality (City, Town, etc.)					
Province/State	Postal/ZIP code				
<b>This insurer certifies that the following policies of insurance are at present in force covering all operations of the Insured, in connection with the contract made between the named insured and Her Majesty the Queen in right of Canada, represented by the Minister of Agriculture and Agri-Food Canada.</b>					
POLICY					
Type	Number	Inception date	Expiry date	Limit of liability (\$)	
Commercial General Liability					
Builder's Risk "All Risks"					
Installation Floater "All Risks"					
Other (list)					
Each of these policies includes the coverages and provisions as specified in Insurance Terms and each policy has been endorsed to cover Her Majesty as an Additional Insured. The Insurer agrees to notify Her Majesty and the Named insured in writing thirty (30) days prior to any material change in, or cancellation of any policy or coverage.					
_____			_____		_____
Name of Insurer's Officer or Authorized Employee			Telephone number		Ext.
_____			_____		
Signature			Date		

## LABOUR AND MATERIAL PAYMENT BOND

BOND NUMBER: \_\_\_\_\_

AMOUNT: \_\_\_\_\_

KNOW ALL PERSONS BY THESE PRESENTS, that \_\_\_\_\_ as Principal,  
hereinafter called the Principal, and \_\_\_\_\_ as Surety,

hereinafter called the Surety, are, subject to the conditions hereinafter contained, held and firmly bound unto Her Majesty the Queen in right of Canada as represented by the Minister of Agriculture and Agri-Food, as Obligee, hereinafter called the Crown, in the amount of

\_\_\_\_\_ dollars (\$ \_\_\_\_\_), lawful money of Canada, for the payment of which sum, well and truly to be made, the Principal and the Surety bind themselves, their heirs, executors, administrators, successors and assigns, jointly and severally, firmly by these presents.

SIGNED AND SEALED this \_\_\_\_\_ day of \_\_\_\_\_, 20\_\_

WHEREAS, the Principal has entered into a Contract with the Crown dated the \_\_\_\_\_ day of \_\_\_\_\_, 20\_\_,  
for \_\_\_\_\_

which contract is by reference made a part hereof, and is hereinafter referred to as the Contract.

NOW, THEREFORE, THE CONDITIONS OF THIS OBLIGATION are such that, if payment is promptly made to all Claimants who have performed labour or services or supplied material in connection with the Contract and any and all duly authorized modifications and extensions of the Contract that may hereafter be made, notice of which modifications and extensions to the Surety being hereby waived, then this obligation shall be void; otherwise it shall remain in full force and effect, subject, however, to the following conditions:

1. For the purpose of this bond, a Claimant is defined as one having a direct contract with the Principal or any Sub-Contractor of the Principal for labour, material or both, used or reasonably required for use in the performance of the Contract, labour and material being construed to include that part of water, gas, power, light, heat, oil, gasoline, telephone services or rental of equipment (but excluding rental of equipment where the rent pursuant to an agreement is to be applied towards the purchase price thereof) directly applicable to the Contract.
2. For the purpose of this Bond, no payment is required to be made in respect of a claim for payment for labour or services performed or material supplied in connection with the Contract that represents a capital expenditure, overhead or general administration costs incurred by the Principal during the currency or in respect of the Contract.
3. The Principal and the Surety hereby jointly and severally agree with the Crown that if any Claimant has not been paid as provided for under the terms of his contract with the Principal or a Sub-Contractor of the Principal before the expiration of a period of ninety (90) days after the date on which the last of such Claimant's labour or service was done or performed or materials were supplied by such Claimant, the Crown may sue on this bond, have the right to prosecute the suit to final judgment for such sum or sums as may be due and have execution thereon; and such right of the Crown is assigned by virtue of Part VIII of the *Financial Administration Act* to such Claimant.
4. For the purpose of this bond the liability of the Surety and the Principal to make payment to any claimant not having a contract directly with the Principal shall be limited to that amount which the Principal would have been obliged to pay to such claimant had the provisions of the applicable provincial or territorial legislation on lien or privileges been applicable to the work. A claimant need not comply with provisions of such legislation setting out steps by way of notice, registration or otherwise as might have been necessary to preserve or perfect any claim for lien or privilege which the claimant might have had. Any such claimant shall be entitled to pursue a claim and to recover judgment hereunder subject to the terms and notification provisions of the Bond.
5. Any material change in the Contract between the Principal and the Crown shall not prejudice the rights or interest of any Claimant under this Bond who is not instrumental in bringing about or has not caused such change.

6. No suit or action shall be commenced hereunder by any Claimant:

- (a) Unless such Claimant shall have given written notice within the time limits hereinafter set forth to the Principal and the Surety above named, stating with substantial accuracy the amount claimed. Such notice shall be served by mailing the same by registered mail to the Principal and the Surety at any place where an office is regularly maintained for the transaction of business by such persons or served in any manner in which legal process may be served in the Province or other part of Canada in which the subject matter of the Contract is located. Such notice shall be given
  - (i) in respect of any claim for the amount or any portion thereof required to be held back from the Claimant by the Principal or by the Sub-Contractor of the Principal under either the terms of the Claimant's Contract with the Principal or the Claimant's Contract with the Sub-Contractor of the Principal within one hundred and twenty (120) days after such Claimant should have been paid in full under this Contract;
  - (ii) in respect of any claim other than for the holdback or portion thereof referred to above within one hundred and twenty (120) days after the date upon which such Claimant did or performed the last of the service, work or labour or furnished the last of the materials for which such claim is made under the Claimant's Contract with the Principal or a Sub-Contractor of the Principal;
- (b) After the expiration of one (1) year following the date on which the Principal ceased work on the said Contract, including work performed under the guarantees provided in the Contract;
- (c) Other than in a court of competent jurisdiction in the province or district of Canada in which the subject matter of the Contract or any part thereof is situated and not elsewhere, and the parties hereto hereby agree to submit to the jurisdiction of such court.

7. The amount of this bond shall be reduced by and to the extent of any payment or payments made in good faith hereunder.

8. The Surety shall not be entitled to claim any moneys relating to the Contract and the liability of the Surety under this Bond shall remain unchanged and, without restricting the generality of the foregoing, the Surety shall pay all valid claims of Claimants under this Bond before any moneys relating to the Contract held by the Crown are paid to the Surety by the Crown.

9. The Surety shall not be liable for a greater sum than the amount specified in this bond.

IN TESTIMONY WHEREOF, the Principal has hereto set its hand and affixed its seal, and the Surety has caused these presents to be sealed with its corporate seal duly attested by the signature of its authorized signing authority, the day and year first above written.

SIGNED, SEALED AND DELIVERED in the presence of:

\_\_\_\_\_  
Principal

\_\_\_\_\_  
Witness

\_\_\_\_\_  
Surety

Note: Affix Corporate seal if applicable.

## PERFORMANCE BOND

**BOND NUMBER:** \_\_\_\_\_

**AMOUNT:** \_\_\_\_\_

KNOW ALL PERSONS BY THESE PRESENTS, that \_\_\_\_\_ as Principal,  
hereinafter called the Principal, and \_\_\_\_\_ as Surety,

hereinafter called the Surety, are, subject to the conditions hereinafter contained, held and firmly bound unto Her Majesty the Queen in right of Canada as represented by the Minister of Agriculture and Agri-Food, as Obligee, hereinafter called the Crown, in the amount of

\_\_\_\_\_ dollars (\$ \_\_\_\_\_), lawful money of Canada, for the payment of which sum, well and truly to be made, the Principal and the Surety bind themselves, their heirs, executors, administrators, successors and assigns, jointly and severally, firmly by these presents.

SIGNED AND SEALED this \_\_\_\_\_ day of \_\_\_\_\_, 20\_\_.

WHEREAS, the Principal entered into a Contract with the Crown dated the \_\_\_\_\_ day of \_\_\_\_\_, 20\_\_,  
for \_\_\_\_\_

which Contract is by reference made a part hereof, and is hereinafter referred to as the Contract.

NOW, THEREFORE, THE CONDITIONS OF THIS OBLIGATION are such that, if the Principal shall well and faithfully observe and perform all the obligations on the part of the Principal to be observed and performed in connection with the Contract, then this obligation shall be void, otherwise it shall remain in full force and effect, subject, however, to the following conditions:

1. Whenever the Principal shall be, and declared by the Crown to be, in default under the Contract, the Surety shall:
  - (a) if the work is not taken out of the Principal's hands, remedy the default of the Principal,
  - (b) if the work is taken out of the Principal's hands and the Crown directs the Surety to undertake the completion of the work, complete the work in accordance with the Contract provided that if a contract is entered into for the completion of the work,
    - (i) it shall be between the Surety and the completing contractor, and
    - (ii) the selection of such completing contractor shall be subject to the approval of the Crown,
  - (c) if the work is taken out of the Principal's hands and the Crown, after reasonable notice to the Surety, does not direct the Surety to undertake the completion of the work, assume the financial responsibility for the cost of completion in excess of the moneys available to the Crown under the Contract,
  - (d) be liable for and pay all the excess costs of completion of the Contract, and
  - (e) not be entitled to any Contract moneys earned by the Principal, up to the date of his default on the Contract and any holdbacks relating to such earned Contract moneys held by the Crown, and the liability of the Surety under this Bond shall remain unchanged provided, however, and without restricting the generality of the foregoing, upon the completion of the Contract to the satisfaction of the Crown, any Contract moneys earned by the Principal or holdbacks related thereto held by the Crown may be paid to the Surety by the Crown.
2. The Surety shall not be liable for a greater sum than the amount specified in this Bond.
3. No suit or action shall be instituted by the Crown herein against the Surety pursuant to these presents after the expiration of two (2) years from the date on which final payment under the Contract is payable.

IN TESTIMONY WHEREOF, the Principal has hereto set its hand and affixed its seal, and the Surety has caused these presents to be sealed with its corporate seal duly attested by the signature of its authorized signing authority, the day and year first above written.

SIGNED, SEALED AND DELIVERED in the presence of:

\_\_\_\_\_  
Principal

\_\_\_\_\_  
Witness

\_\_\_\_\_  
Surety

Note: Affix Corporate seal if applicable.



T4-A CERTIFICATION

The Contractor shall complete and submit this T4-A Certification within fourteen (14) calendar days of Notification of Contract award and within fourteen (14) calendar days immediately following any change to the information already provided under the Contract. Failure to provide this information or failure to provide the correct information shall result in a fundamental breach of the Contract.

1. The Contractor shall enter a [ x ] in one of the boxes below opposite the description that best describes its status.

- [ ] A business incorporated either federally or provincially;
[ ] An unincorporated business, either as a sole proprietor or a partnership; or
[ ] An individual.

Note: The information provided in Section 2 must correspond with that provided in Section 1.

Corporate or unincorporated business or individual's name: \_\_\_\_\_

Street Name or Box #: \_\_\_\_\_

City, Town or Village: \_\_\_\_\_

Province: \_\_\_\_\_

Postal Code: \_\_\_\_\_

2. Contractor shall complete Section 2(a) or 2(b) or 2(c), whichever is applicable to its situation.

(a) If incorporated:

Business Number (BN): \_\_\_\_\_, or
GST / HST Number: \_\_\_\_\_, or
T2 Corporation Tax Number (T2N): \_\_\_\_\_, whichever is applicable

(b) If unincorporated:

Social Insurance Number (SIN): \_\_\_\_\_, and
Business Number (BN): \_\_\_\_\_, or
GST / HST Number: \_\_\_\_\_, whichever is applicable

Note: The Unincorporated Business Name must be the same as the name associated with the Revenue Canada Business Number or the GST Number.

(c) If individual:

Social Insurance Number (SIN): \_\_\_\_\_, and
Business Number (BN): \_\_\_\_\_, or
GST / HST Number: \_\_\_\_\_, whichever is applicable

Note: The Individual's Name must be the same as the name associated with the Social Insurance Number.

3. WE HEREBY CERTIFY that I/We have examined the information provided above, including the legal name, address and Revenue Canada identifier (SIN, BN, GST / HST No., T2N), as applicable, and that it is correct and complete, and fully discloses my/our identification.

Contractor's signature Title of Signatory Date