

# LOCK 23 CONCRETE CANAL WALL REHABILITATION

## TRENT SEVERN WATERWAY, ONTARIO

### DRAWING INDEX:

TP-00 - TITLE PAGE

- MA-01 - EXISTING CONDITIONS
- MA-02 - EXISTING CONDITIONS
- MA-03 - EXISTING CONDITIONS, DEMOLITION AND REMOVALS
- MA-04 - TYP. EXISTING SECTIONS
- MA-05 - REPAIR LIMITS AND TYP. DETAILS
- MA-06 - TYP. REPAIR DETAILS
- MA-07 - TYP. REPAIR DETAILS
- MA-08 - TYP. REPAIR DETAILS

- C-01 - NEW STRUCTURE LAYOUT AND SITE ACCESS
- C-02 - TYP. SECTIONS
- C-03 - TYP. DETAILS
- C-04 - TYP. DETAILS

- D-01 - TYP. DETAILS
- D-02 - TYP. DETAILS

- L-01 - NEW LANDSCAPE PLAN AND TYP. DETAILS

 TRENT SEVERN WATERWAY,  
NATIONAL HISTORIC SITE OF CANADA,  
PARKS CANADA AGENCY

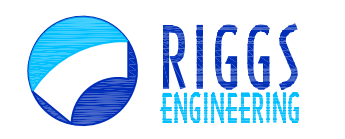



**RIGGS ENGINEERING** Ltd.  
1240 COMMISSIONERS Rd. WEST  
SUITE 205  
LONDON, ONTARIO  
N6K 1C7  
(519)-657-1040  
WWW.RIGGSENGINEERING.COM



revision	description	date
0	ISSUED FOR TENDER	06/17/2015

Do not scale drawings.  
Verify all dimensions and conditions on site and immediately notify the department representative of all discrepancies.

-  A Detail No.  
No. du détail
-  B drawing no. - where detail required  
dessin no. - où détail exigé
-  C drawing no. - where detailed  
dessin no. - où détaillé

project title  
titre du projet  
**PETERBOROUGH ONTARIO**

CONCRETE CANAL WALL REHABILITATION  
LOCK 23, TRENT SEVERN WATERWAY, PARKS  
CANADA AGENCY

drawing title  
titre du dessin  
**TITLE PAGE**

drawn by  
dessiné par **A.MARCZENKO**

designed by  
conçue par

approved by  
approuvé par

tender  
soumission **DUNCAN MANSER** project manager  
administrateur de projets

project date  
date du projet **JUNE 16, 2015**

project no.  
no. du projet **30025771-4272-33**

drawing no.  
dessiné no. **TP-00**

- LEGEND:**
- BM# BENCHMARK
  - × 213.21 ELEVATIONS RELATIVE TO SITE BENCHMARK
  - 210.7 SOUNDINGS RELATIVE TO SITE BENCHMARK
  - EXISTING MOORING RING LOCATIONS
  - ▲ EXISTING CAST IRON BUTTON BOLLARDS

TRENT SEVERN WATERWAY,  
NATIONAL HISTORIC SITE OF CANADA,  
PARKS CANADA AGENCY

- NOTES:**
- 1) SURVEY DATA WAS COLLECTED ON DECEMBER 5, 9 & 10 OF 2014.
  - 2) ELEVATIONS AND SOUNDINGS ARE SHOWN IN METERS.
  - 3) ELEVATIONS AND SOUNDINGS ARE REFERENCED TO BENCHMARK #0011960U525 HAVING AN ELEVATION OF 221.10 METERS.
  - 4) WATER LEVEL ELEVATION AT THE TIME OF SURVEY WAS 215.85 METERS.
  - 5) POSITIONING SYSTEM - HEMISPHERE R320
  - 6) SOUNDER - RESON NAVISOUND 110

\* THE SOUNDING INFORMATION REPRESENTS RESULTS OF THE SURVEY MADE ON THE DATES SPECIFIED AND CAN ONLY BE CONSIDERED AS INDICATING THE CONDITIONS AT THAT TIME.

• Soundings are valid only for the date and time they were taken.  
• This plan is NOT FOR NAVIGATION  
• In the ordinary practice of good seamanship, navigators use updated hydrographic charts for navigation of their vessels.

**RIGGS ENGINEERING**  
RIGGS ENGINEERING Ltd.  
1240 COMMISSIONERS Rd. WEST  
SUITE 205  
LONDON, ONTARIO  
N6K 1C7  
(519)-657-1040  
WWW.RIGGSENGINEERING.COM



0	ISSUED FOR TENDER	06/17/2015
revision		date

Do not scale drawings. Verify all dimensions and conditions on site and immediately notify the department representative of all discrepancies.

A B C	A	Detail No.
	B	No. du détail
	C	No. where detail required / dessin no. - où détail exigé

project title / titre du projet  
**PETERBOROUGH ONTARIO**

CONCRETE CANAL WALL REHABILITATION  
LOCK 23, TRENT SEVERN WATERWAY, PARKS CANADA AGENCY

drawing title / titre du dessin  
**LOCK 23 EXISTING CONDITIONS**

drawn by / dessiné par  
**A.MARCZENKO**

designed by / conçu par

approved by / approuvé par

tender submission / soumission de projet  
**DUNCAN MANSER** project manager / administrateur de projets

project date / date du projet  
**JUNE 16, 2015**

project no. / no. du projet  
**30025771-4272-33**

drawing no. / dessin no.  
**MA-01**

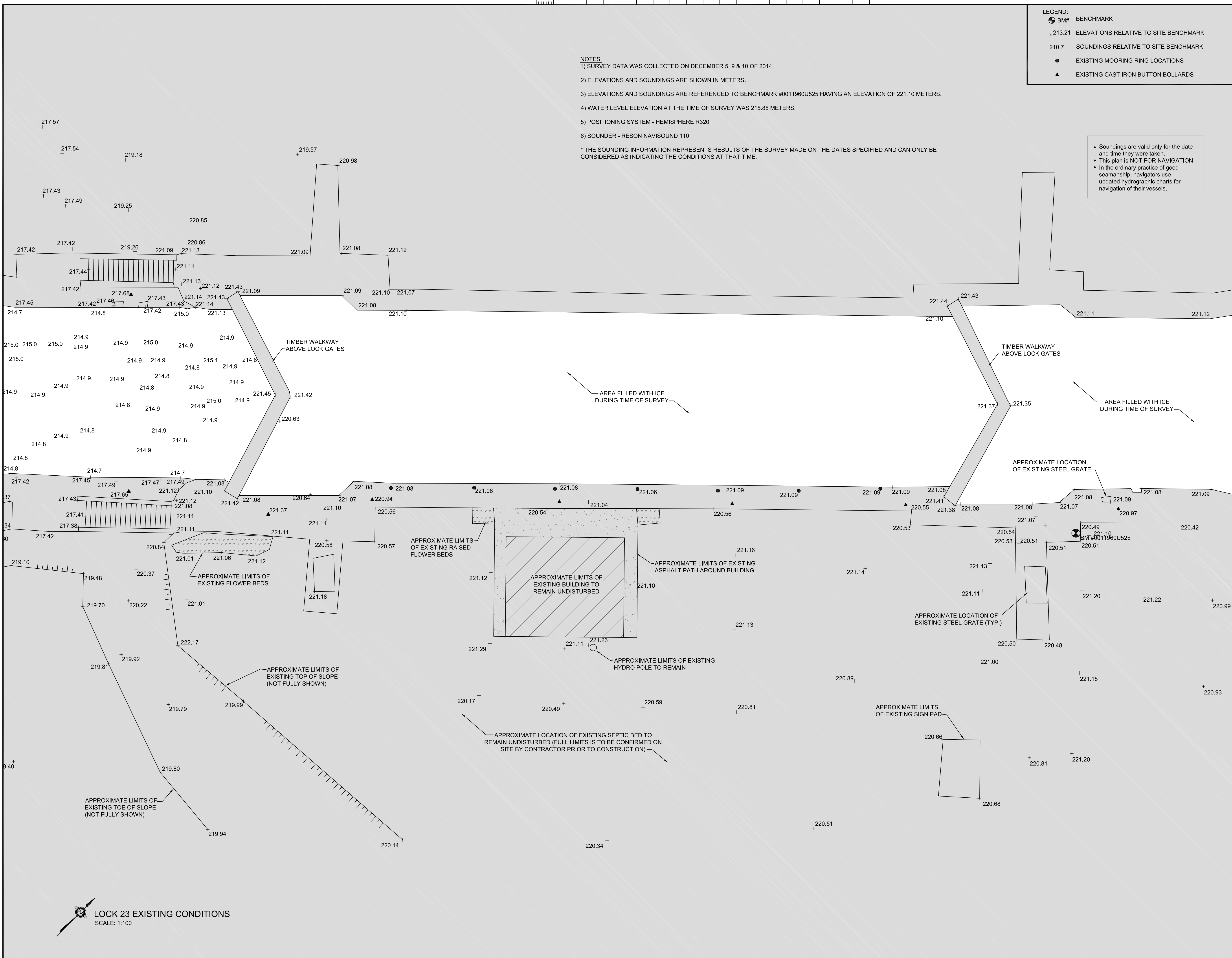

**LOCK 23 EXISTING CONDITIONS**  
SCALE: 1:100

0 10 20 30 40 50 60 70 80 90 100 110 120 130 140 150 160 170 180 190 200 millimetres

- LEGEND:**
- BM# BENCHMARK
  - x 213.21 ELEVATIONS RELATIVE TO SITE BENCHMARK
  - 210.7 SOUNDINGS RELATIVE TO SITE BENCHMARK
  - EXISTING MOORING RING LOCATIONS
  - ▲ EXISTING CAST IRON BUTTON BOLLARDS

- NOTES:**
- 1) SURVEY DATA WAS COLLECTED ON DECEMBER 5, 9 & 10 OF 2014.
  - 2) ELEVATIONS AND SOUNDINGS ARE SHOWN IN METERS.
  - 3) ELEVATIONS AND SOUNDINGS ARE REFERENCED TO BENCHMARK #0011960U525 HAVING AN ELEVATION OF 221.10 METERS.
  - 4) WATER LEVEL ELEVATION AT THE TIME OF SURVEY WAS 215.85 METERS.
  - 5) POSITIONING SYSTEM - HEMISPHERE R320
  - 6) SOUNDER - RESON NAVISOUND 110
- \* THE SOUNDING INFORMATION REPRESENTS RESULTS OF THE SURVEY MADE ON THE DATES SPECIFIED AND CAN ONLY BE CONSIDERED AS INDICATING THE CONDITIONS AT THAT TIME.

- Soundings are valid only for the date and time they were taken.
- This plan is NOT FOR NAVIGATION
- In the ordinary practice of good seamanship, navigators use updated hydrographic charts for navigation of their vessels.

TRENT SEVERN WATERWAY,  
NATIONAL HISTORIC SITE OF CANADA,  
PARKS CANADA AGENCY

**RIGGS ENGINEERING**  
RIGGS ENGINEERING Ltd.  
1240 COMMISSIONERS Rd. WEST  
SUITE 205  
LONDON, ONTARIO  
N6K 1C7  
(519)-657-1040  
WWW.RIGGSENGINEERING.COM



revision	description	date
0	ISSUED FOR TENDER	06/17/2015

Do not scale drawings.  
Verify all dimensions and conditions on site and immediately notify the department representative of all discrepancies.

- A Detail No. / No. du détail
- B drawing no. - where detail required / dessin no. - où détail exigé
- C drawing no. - where detailed / dessin no. - où détaillé

project title / titre du projet  
**PETERBOROUGH ONTARIO**

CONCRETE CANAL WALL REHABILITATION  
LOCK 23, TRENT SEVERN WATERWAY, PARKS  
CANADA AGENCY

drawing title / titre du dessin  
**LOCK 23  
EXISTING CONDITIONS**

drawn by / dessiné par  
**A.MARCZENKO**

designed by / conçu par

approved by / approuvé par

tender submission / soumission de projet  
**DUNCAN MANSER** project manager / administrateur de projets

project date / date du projet  
**JUNE 16, 2015**

project no. / no. du projet  
**30025771-4272-33**

drawing no. / dessin no.  
**MA-02**

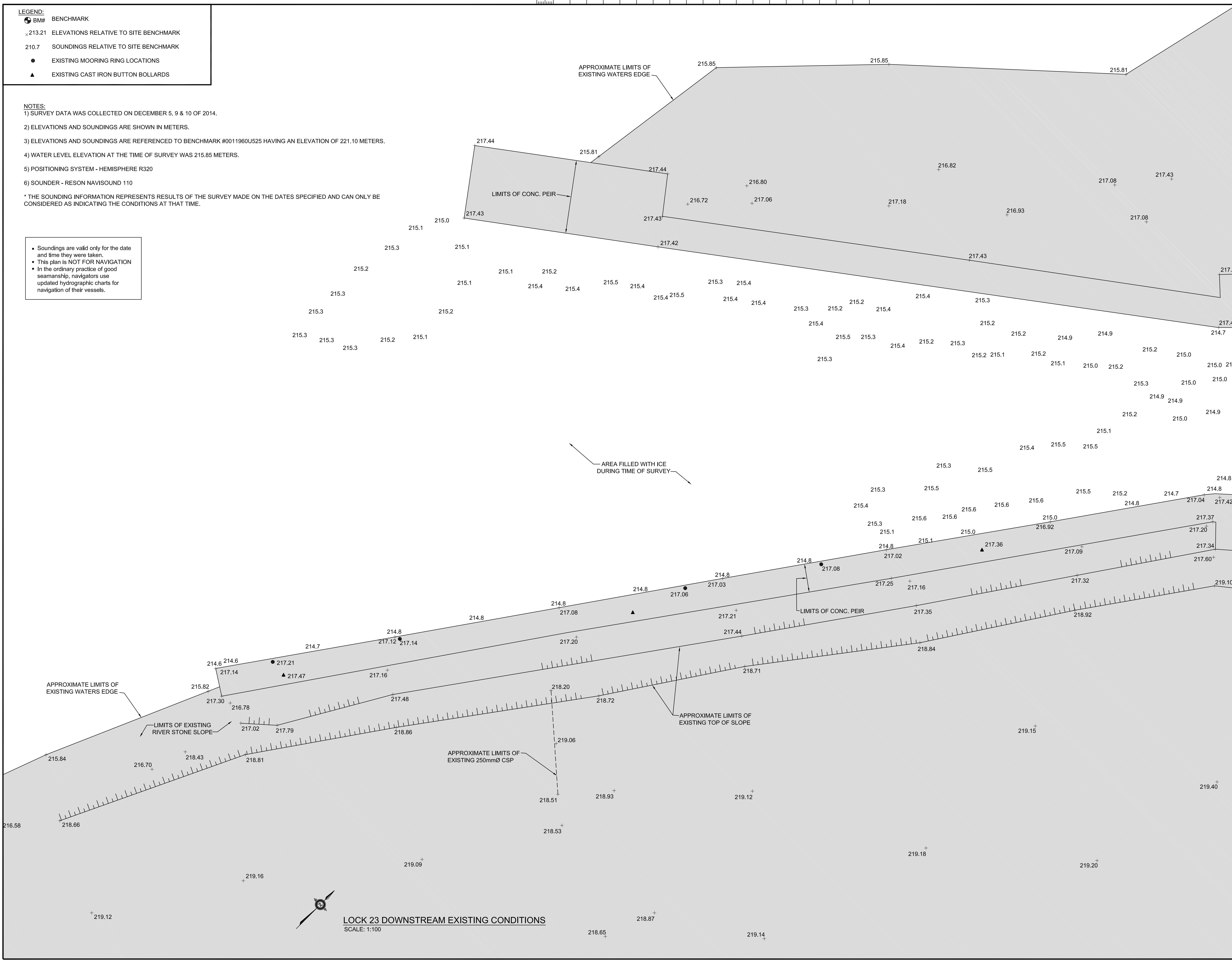

**LOCK 23 DOWNSTREAM EXISTING CONDITIONS**  
SCALE: 1:100



revision	description	date
1	REVISED DETAILS	07/02/2015
0	ISSUED FOR TENDER	06/17/2015

Do not scale drawings.  
Verify all dimensions and conditions on site and immediately notify the department representative of all discrepancies.

Detail No.	No. du détail
A	Detail No. - where detail required dessin no. - où détail exigé
B	drawing no. - where detailed dessin no. - où détaillé
C	drawing no. - where detailed dessin no. - où détaillé

project title  
titre du projet  
**PETERBOROUGH ONTARIO**

CONCRETE CANAL WALL REHABILITATION  
LOCK 23, TRENT SEVERN WATERWAY, PARKS  
CANADA AGENCY

drawing title  
titre du dessin  
**LOCK 23 EXISTING  
CONDITIONS, DEMOLITION  
AND REMOVALS**

drawn by  
dessiné par  
**A.MARCZENKO**

designed by  
conc par  
**P.L. / W.H. / A.M.**

approved by  
approuvé par  
**P.LAMPKIN**

tender  
soumission  
**DUNCAN MANSER**

project manager  
administrateur  
de projets

project date  
date du projet  
**JUNE 16, 2015**

project no.  
no. du projet  
**30025771-4272-33**

drawing no.  
dessiné no.  
**MA-03**



**LOCK 23 ELEVATION VIEW (WEST WALL)**  
SCALE: N.T.S.

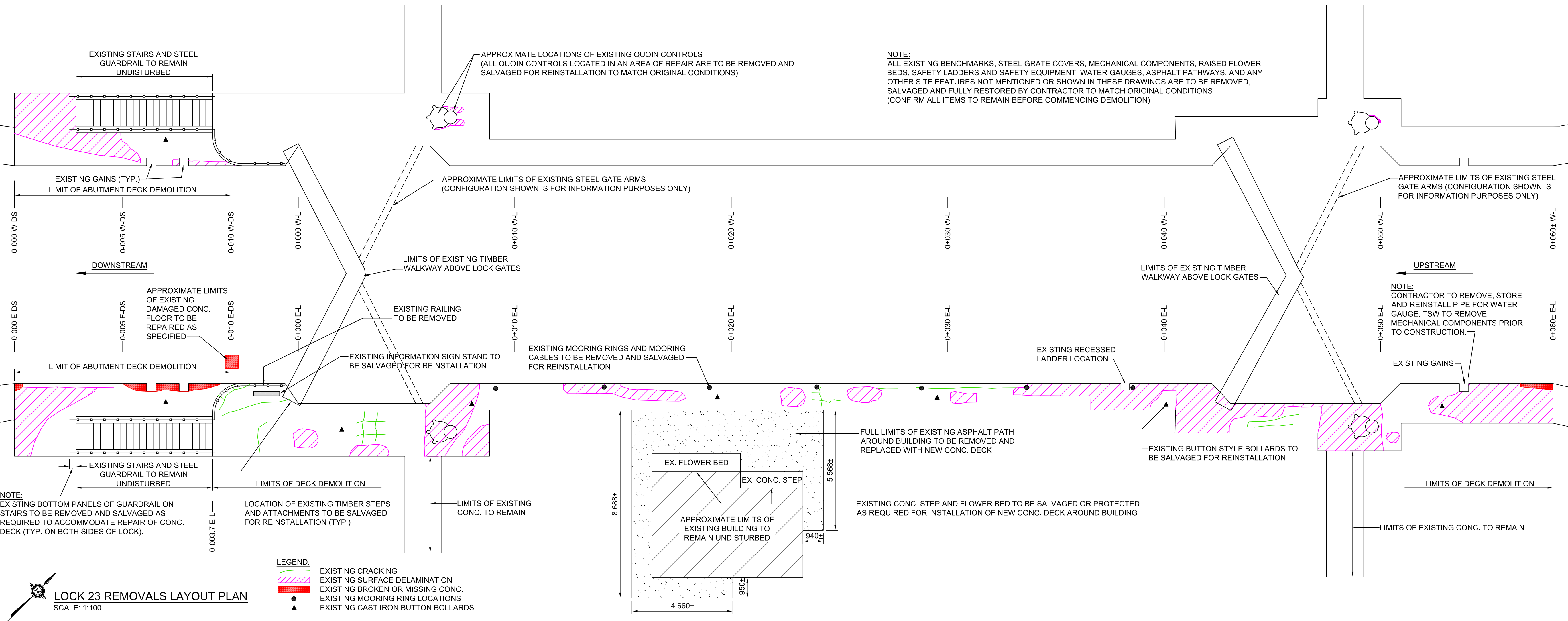

**LOCK 23 REMOVALS LAYOUT PLAN**  
SCALE: 1:100



NOTE:  
THE PHOTOGRAPH SHOWN OF THE EAST WALL HAS BEEN MIRRORED SO THE ORIENTATION IS A MATCH WITH THE STATIONING SHOWN ON THE REMOVALS LAYOUT PLAN. THE PHOTOGRAPH SHOWN IS FOR INFORMATION PURPOSES ONLY TO HELP WITH THE VISUALIZATION OF THE EXISTING DAMAGES ON THE VERTICAL FACE OF THE LOCK WALLS.



**LOCK 23 ELEVATION VIEW (EAST WALL)**  
SCALE: N.T.S.

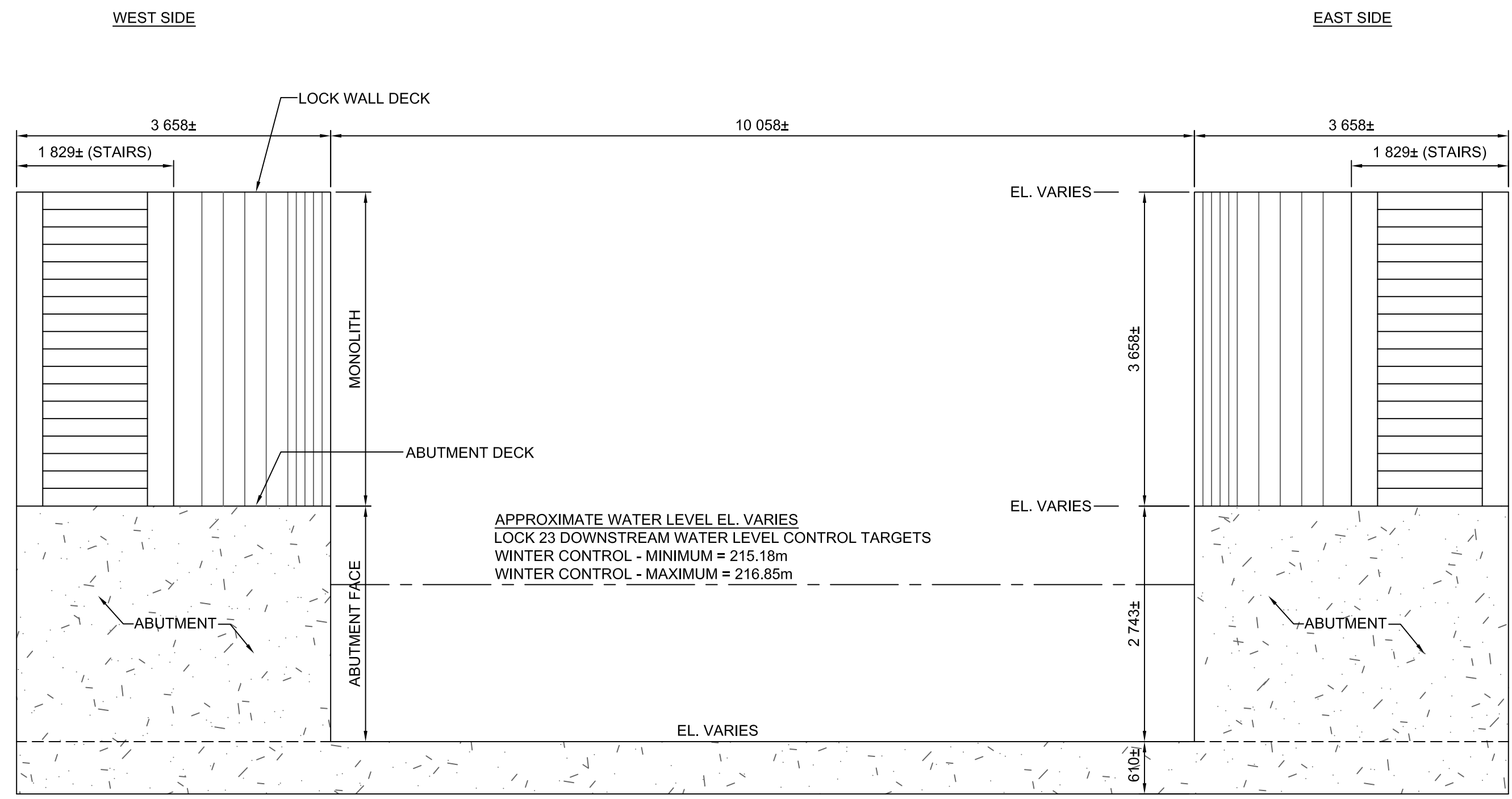

**EXISTING STRUCTURE CONSTRUCTION (DOWNSTREAM) - 0+000 DS TO 0+010 DS**  
SCALE: 1:50

**NOTE:**  
1) DIMENSIONS SHOWN IN THESE DETAILS ARE FROM HISTORIC DRAWING RECORDS AND ARE FOR INFORMATION PURPOSES ONLY.  
2) THE LEVELS AND FLOWS CONTAINED WITHIN THE ATTACHED HAVE BEEN PROVIDED TO THE CONTRACTOR FOR GUIDANCE ONLY AND SHOULD NOT BE ASSUMED TO BE ABSOLUTE. ANOMALIES IN WEATHER AND OTHER FORCES BEYOND THE CONTROL OF PARKS CANADA HAVE THE ABILITY TO GENERATE CONDITIONS UNFORESEEN. IT IS THE RESPONSIBILITY OF THE CONTRACTOR TO ENSURE THE CONSTRUCTED WORKS HAVE THE ABILITY TO WITHSTAND THESE CONDITIONS.

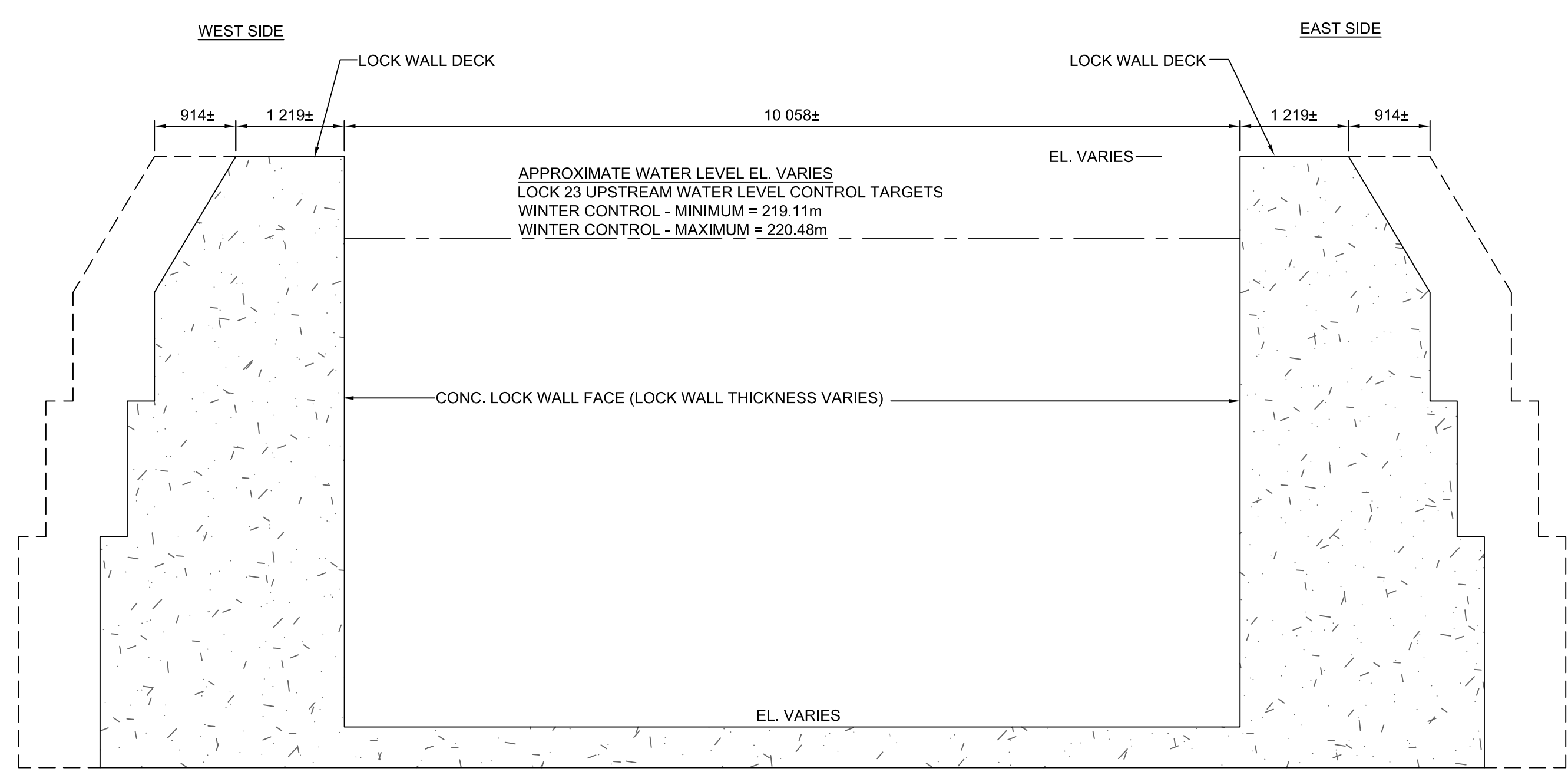

**EXISTING STRUCTURE CONSTRUCTION (LOCK WALLS) - 0+007 L TO 0+043 L**  
SCALE: 1:50

**NOTE:**  
1) DIMENSIONS SHOWN IN THESE DETAILS ARE FROM HISTORIC DRAWING RECORDS AND ARE FOR INFORMATION PURPOSES ONLY.  
2) THE LEVELS AND FLOWS CONTAINED WITHIN THE ATTACHED HAVE BEEN PROVIDED TO THE CONTRACTOR FOR GUIDANCE ONLY AND SHOULD NOT BE ASSUMED TO BE ABSOLUTE. ANOMALIES IN WEATHER AND OTHER FORCES BEYOND THE CONTROL OF PARKS CANADA HAVE THE ABILITY TO GENERATE CONDITIONS UNFORESEEN. IT IS THE RESPONSIBILITY OF THE CONTRACTOR TO ENSURE THE CONSTRUCTED WORKS HAVE THE ABILITY TO WITHSTAND THESE CONDITIONS.

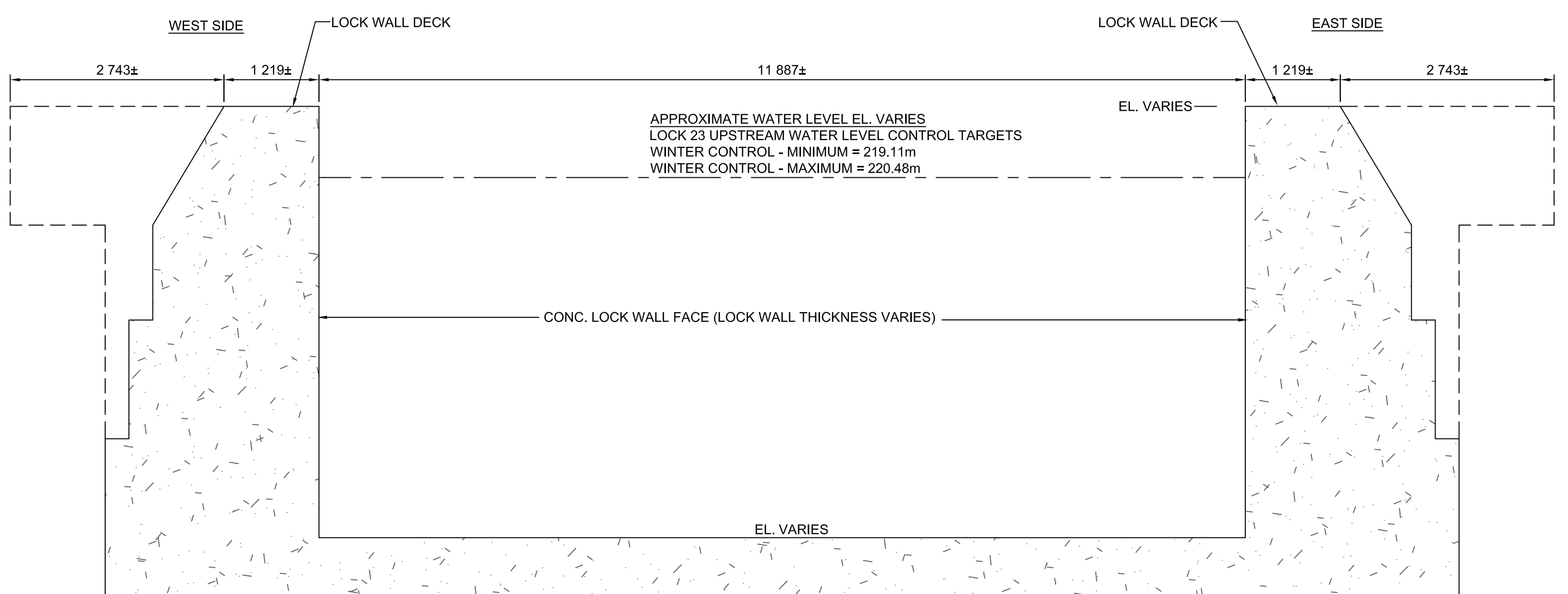

**EXISTING STRUCTURE CONSTRUCTION (LOCK WALLS) - 0+000L TO 0+007L AND 0+043L TO 0+051L**  
SCALE: 1:50

**NOTE:**  
1) DIMENSIONS SHOWN IN THESE DETAILS ARE FROM HISTORIC DRAWING RECORDS AND ARE FOR INFORMATION PURPOSES ONLY.  
2) THE LEVELS AND FLOWS CONTAINED WITHIN THE ATTACHED HAVE BEEN PROVIDED TO THE CONTRACTOR FOR GUIDANCE ONLY AND SHOULD NOT BE ASSUMED TO BE ABSOLUTE. ANOMALIES IN WEATHER AND OTHER FORCES BEYOND THE CONTROL OF PARKS CANADA HAVE THE ABILITY TO GENERATE CONDITIONS UNFORESEEN. IT IS THE RESPONSIBILITY OF THE CONTRACTOR TO ENSURE THE CONSTRUCTED WORKS HAVE THE ABILITY TO WITHSTAND THESE CONDITIONS.

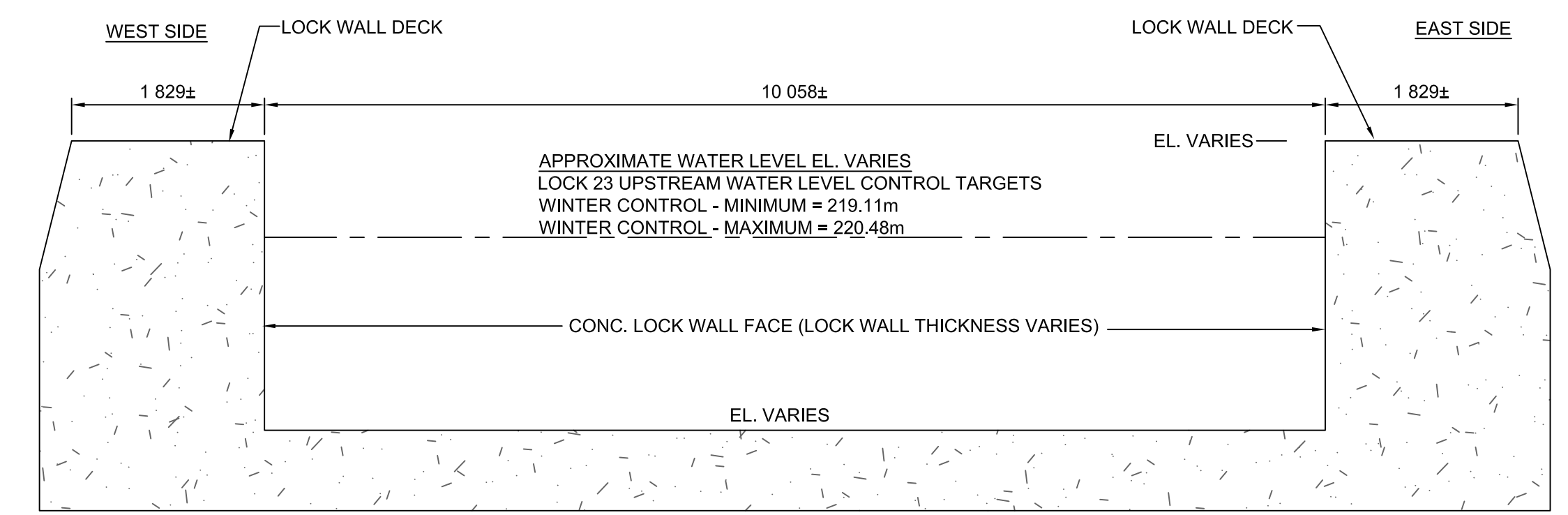

**EXISTING STRUCTURE CONSTRUCTION (LOCK WALLS) - 0+051 L TO 0+060 L**  
SCALE: 1:50

**NOTE:**  
1) DIMENSIONS SHOWN IN THESE DETAILS ARE FROM HISTORIC DRAWING RECORDS AND ARE FOR INFORMATION PURPOSES ONLY.  
2) THE LEVELS AND FLOWS CONTAINED WITHIN THE ATTACHED HAVE BEEN PROVIDED TO THE CONTRACTOR FOR GUIDANCE ONLY AND SHOULD NOT BE ASSUMED TO BE ABSOLUTE. ANOMALIES IN WEATHER AND OTHER FORCES BEYOND THE CONTROL OF PARKS CANADA HAVE THE ABILITY TO GENERATE CONDITIONS UNFORESEEN. IT IS THE RESPONSIBILITY OF THE CONTRACTOR TO ENSURE THE CONSTRUCTED WORKS HAVE THE ABILITY TO WITHSTAND THESE CONDITIONS.

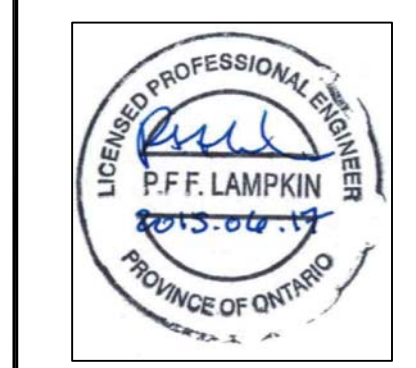

revision	description	date
0	ISSUED FOR TENDER	06/17/2015

Do not scale drawings.  
Verify all dimensions and conditions on site and immediately notify the department representative of all discrepancies.

Detail No.	No. du détail
A	drawing no. - where detail required dessin no. - où détail exigé
B	drawing no. - where detailed dessin no. - où détaillé

project title  
titre du projet  
**PETERBOROUGH ONTARIO**

**CONCRETE CANAL WALL REHABILITATION  
LOCK 23, TRENT SEVERN WATERWAY, PARKS  
CANADA AGENCY**

drawing title  
titre du dessin  
**LOCK 23  
TYP. EXISTING SECTIONS**

drawn by  
dessiné par  
**A.MARCZENKO**

designed by  
conc par

approved by  
approuvé par

tender  
soumission  
**DUNCAN MANSER** project manager  
administrateur de projets

project date  
date du projet  
**JUNE 16, 2015**

project no.  
no. du projet  
**30025771-4272-33**

drawing no.  
dessiné no.  
**MA-04**



revision	description	date
1	REVISED DETAILS	07/02/2015
0	ISSUED FOR TENDER	06/17/2015

Do not scale drawings.  
Verify all dimensions and conditions on site and immediately notify the department representative of all discrepancies.

Detail No.	Description
A	Detail No. / No. du détail
B	drawing no. - where detail required / dessin no. - où détail exigé
C	drawing no. - where detailed / dessin no. - où détaillé

project title / titre du projet  
**PETERBOROUGH ONTARIO**

CONCRETE CANAL WALL REHABILITATION  
LOCK 23, TRENT SEVERN WATERWAY, PARKS  
CANADA AGENCY

drawing title / titre du dessin  
**LOCK 23 REPAIR LIMITS  
AND TYP. DETAILS**

drawn by / dessiné par: **A.MARCZENKO**

designed by / conçu par: **P.L. / W.H. / A.M.**

approved by / approuvé par: **P.LAMPKIN**

tender submission / soumission: **DUNCAN MANSER** project manager / administrateur de projets

project date / date du projet: **JUNE 16, 2015**

project no. / no. du projet: **30025771-4272-33**

drawing no. / dessin no.: **MA-05**

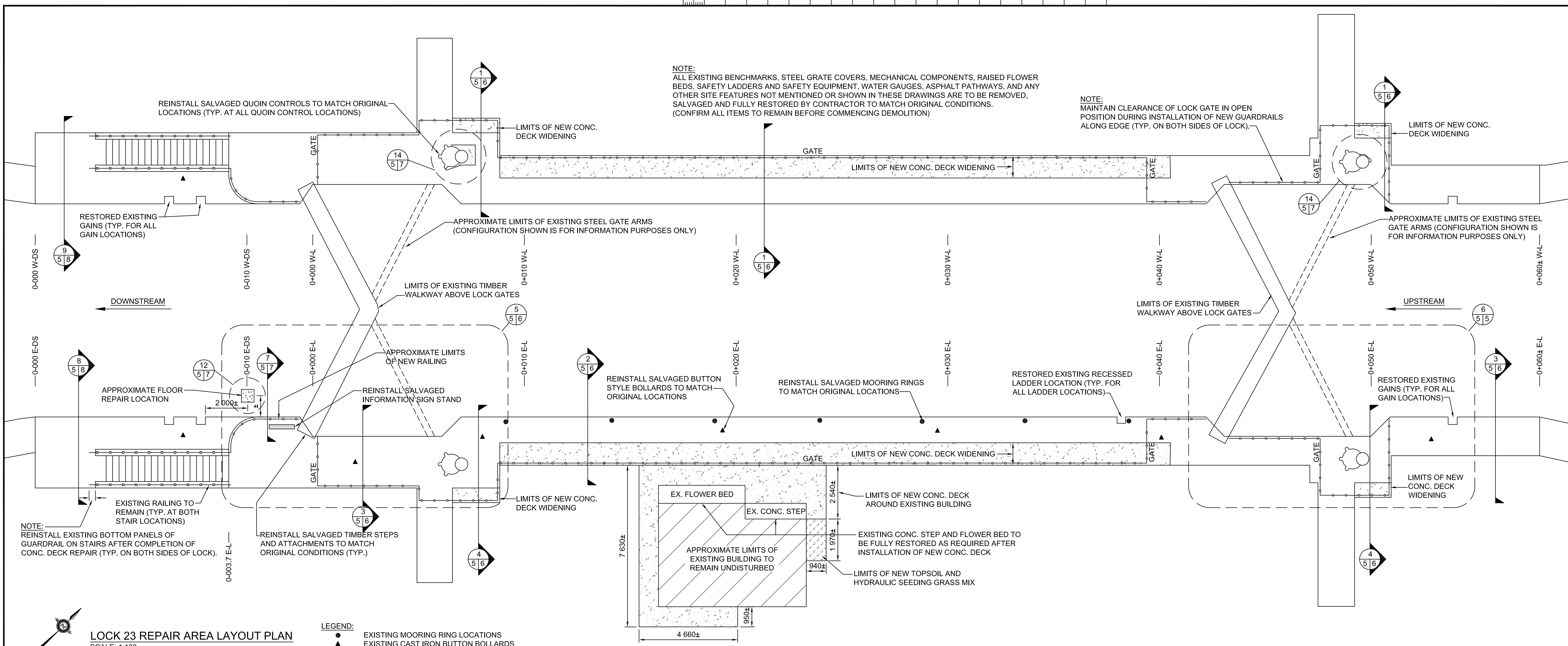

NOTE:  
ALL EXISTING BENCHMARKS, STEEL GRATE COVERS, MECHANICAL COMPONENTS, RAISED FLOWER BEDS, SAFETY LADDERS AND SAFETY EQUIPMENT, WATER GAUGES, ASPHALT PATHWAYS, AND ANY OTHER SITE FEATURES NOT MENTIONED OR SHOWN IN THESE DRAWINGS ARE TO BE REMOVED, SALVAGED AND FULLY RESTORED BY CONTRACTOR TO MATCH ORIGINAL CONDITIONS.  
(CONFIRM ALL ITEMS TO REMAIN BEFORE COMMENCING DEMOLITION)

NOTE:  
MAINTAIN CLEARANCE OF LOCK GATE IN OPEN POSITION DURING INSTALLATION OF NEW GUARDRAILS ALONG EDGE (TYP. ON BOTH SIDES OF LOCK).

NOTE:  
REINSTALL EXISTING BOTTOM PANELS OF GUARDRAIL ON STAIRS AFTER COMPLETION OF CONC. DECK REPAIR (TYP. ON BOTH SIDES OF LOCK).

**LOCK 23 REPAIR AREA LAYOUT PLAN**  
SCALE: 1:100

LEGEND:  
● EXISTING MOORING RING LOCATIONS  
▲ EXISTING CAST IRON BUTTON BOLLARDS

**East Face Repairs**

**Upstream Lockwall**

Station Limits	Depth (m)	Area (m <sup>2</sup> )
0+003.7 to 0+000.0	3.65	13.51
0+000.0 to 0+003.7	0.30	1.11
0+003.7 to 0+005.6	0.75	1.43
0+005.6 to 0+006.7	0.60	0.66
0+006.7 to 0+007.1	0.50	0.20
0+007.1 to 0+011.9	0.30	1.44
0+011.9 to 0+015.8	0.45	1.76
0+015.8 to 0+021.0	0.30	1.56
0+021.0 to 0+022.6	0.30	0.48
0+022.6 to 0+032.1	0.30	2.85
0+032.1 to 0+036.1	0.30	1.20
0+036.1 to 0+038.2	0.45	0.95
0+038.2 to 0+043.5	0.60	3.18
0+043.5 to 0+046.4	0.80	2.32
0+046.4 to 0+048.2	0.30	0.54
0+048.2 to 0+054.0	0.30	1.74
0+054.0 to 0+055.4	0.30	0.42
0+055.4 to 0+060.0	0.65	2.99

**East Abutment Face Repairs**

**Downstream**

Station Limits	Depth (m)	Area (m <sup>2</sup> )
0+000.0 to 0+010.0	2.72	27.2

**West Abutment Face Repairs**

**Downstream**

Station Limits	Depth (m)	Area (m <sup>2</sup> )
0+000.0 to 0+005.5	0.30	1.65
0+005.5 to 0+010.8	0.40	2.12

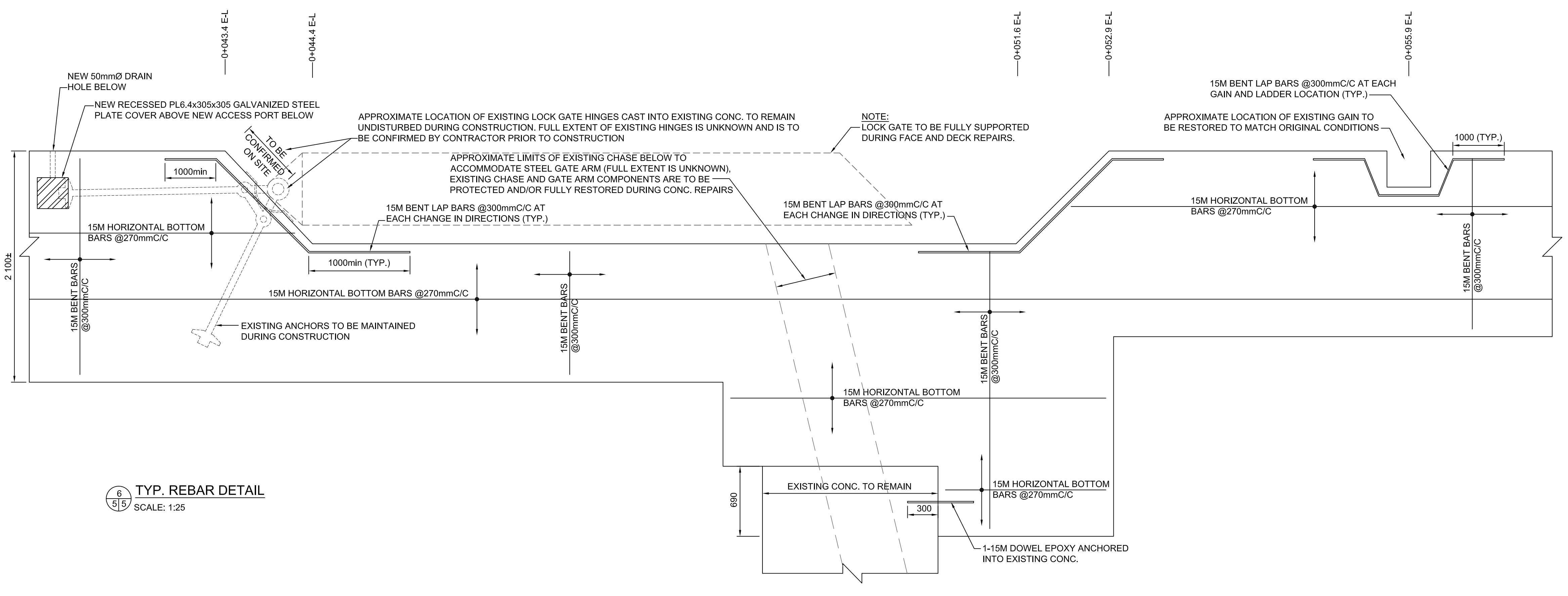

**TYP. REBAR DETAIL**  
SCALE: 1:25

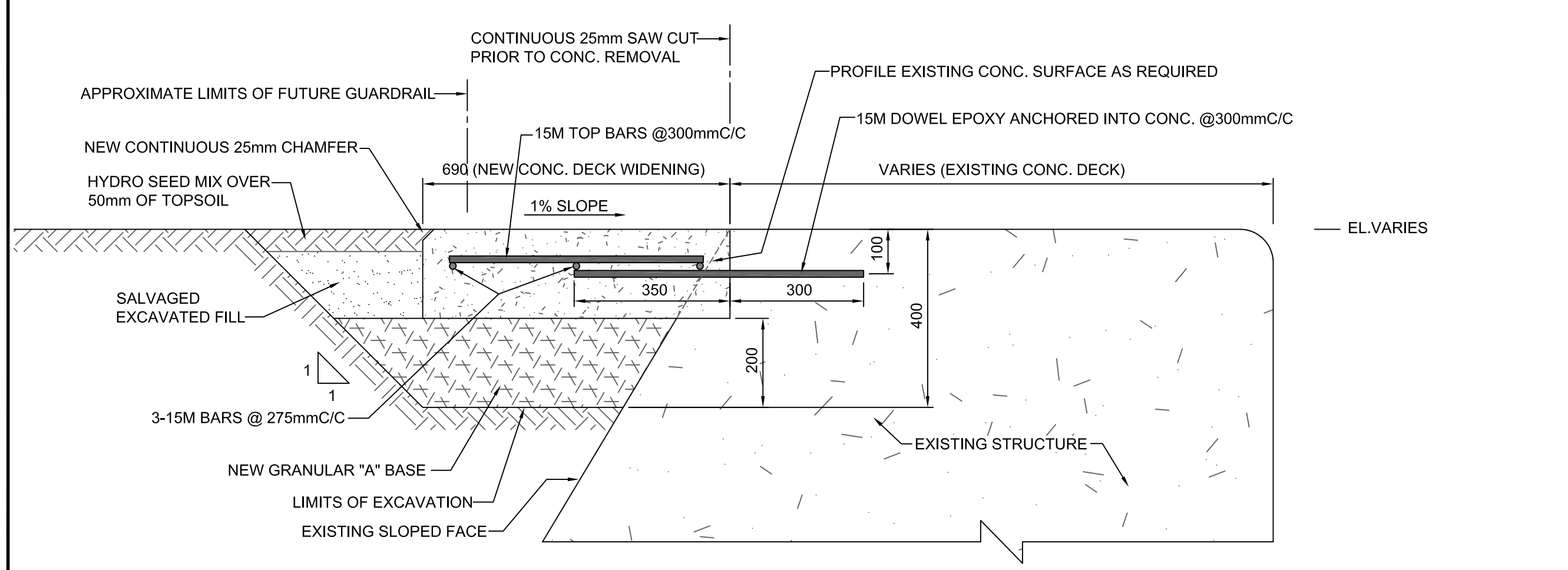

1  
5/6  
CONC. DECK WIDENING DETAIL WEST SIDE - (0+006± W-L TO 0+041.75 W-L) AND (0+049± W-L TO 0+051± W-L)  
SCALE: 1:10

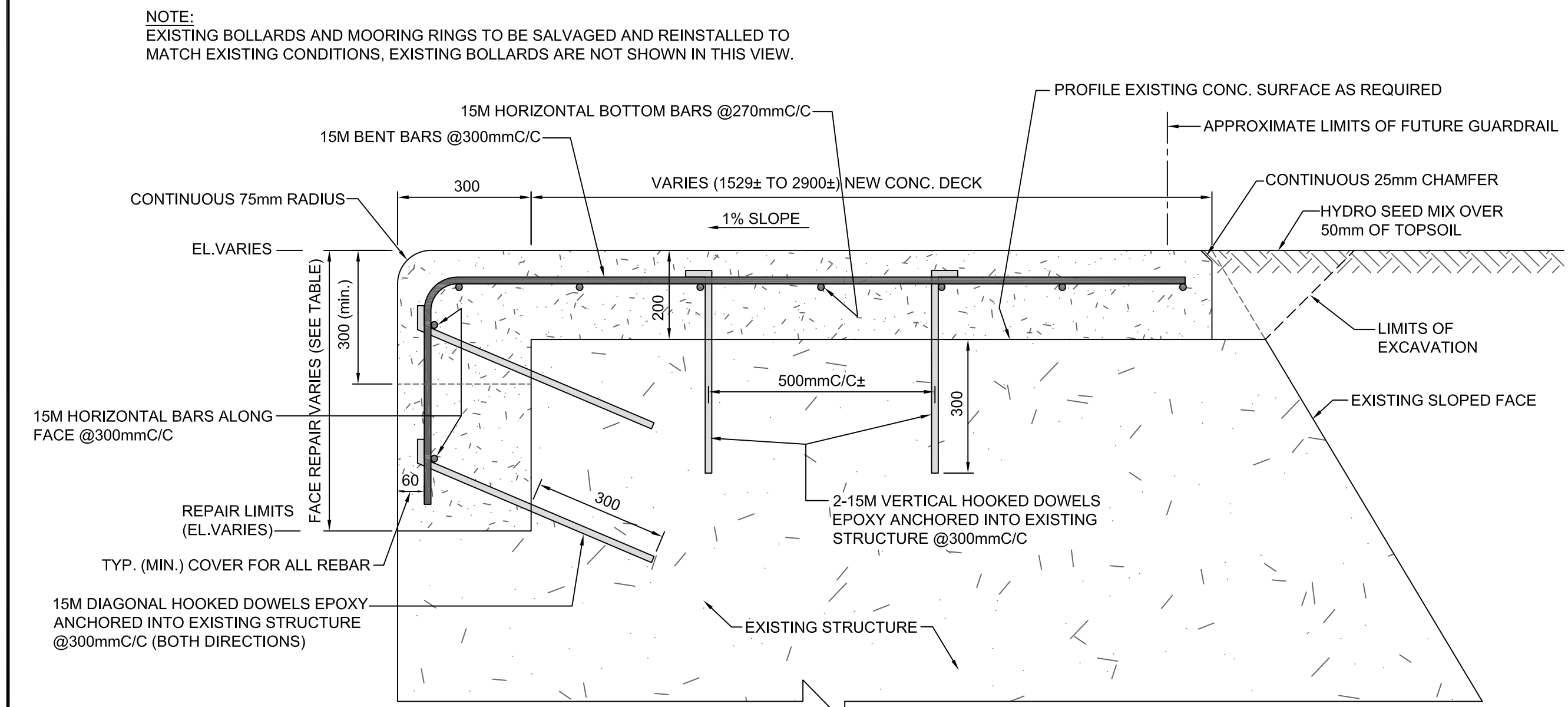

3  
5/6  
CONC. DECK REPAIR DETAIL EAST SIDE - (0-003.7 E-L TO 0+006 E-L), (0+041.75 E-L TO 0+049 E-L) AND (0+051 E-L TO 0+060 E-L)  
SCALE: 1:10

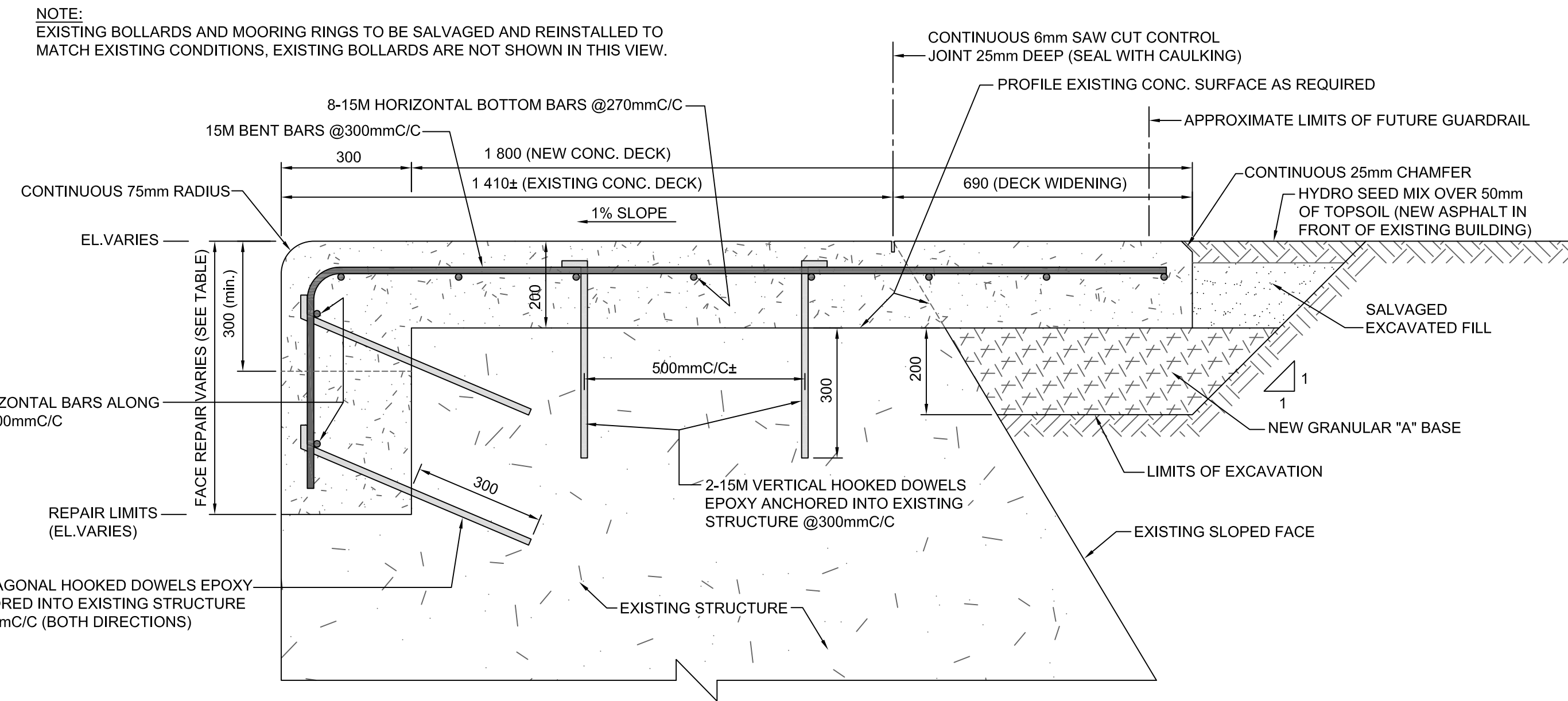

2  
5/6  
CONC. DECK REPAIR DETAIL EAST SIDE - (0+010.5 E-L TO 0+041.75 E-L)  
SCALE: 1:10

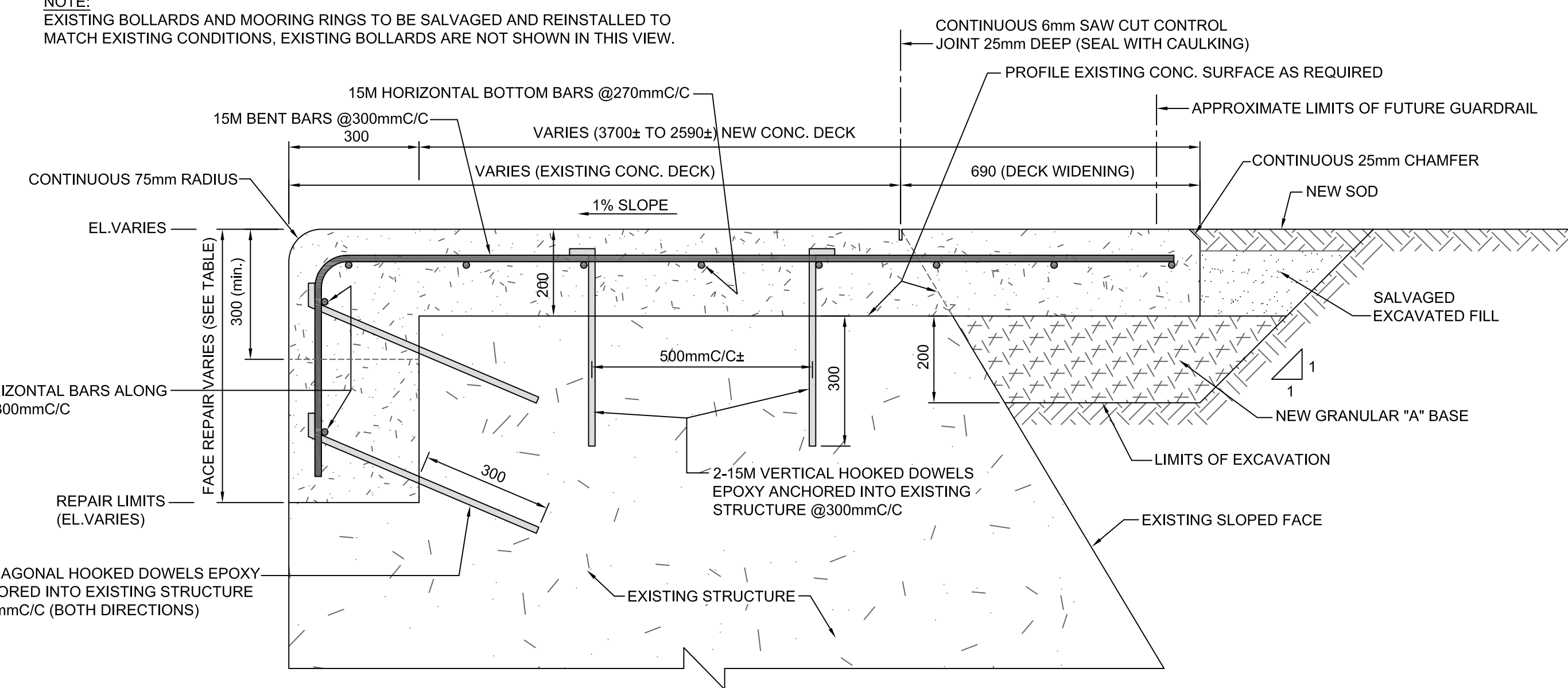

4  
5/6  
CONC. DECK REPAIR DETAIL EAST SIDE - (0+006 E-L TO 0+010.5 E-L) AND (0+049 E-L TO 0+051 E-L)  
SCALE: 1:10

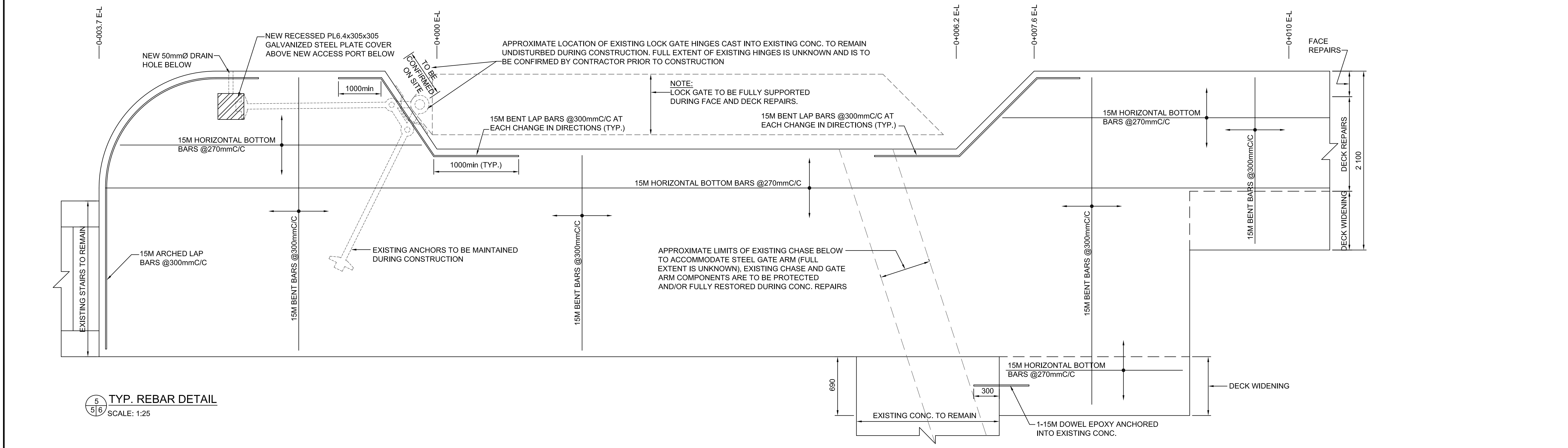

5  
5/6  
TYP. REBAR DETAIL  
SCALE: 1:25

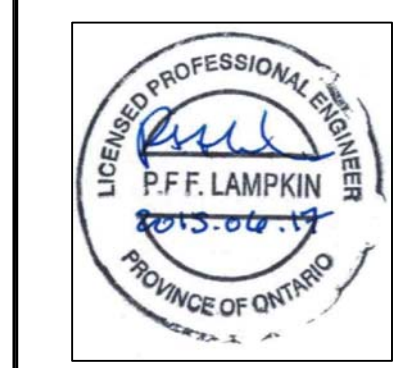

0	ISSUED FOR TENDER	06/17/2015
revision		date

Do not scale drawings.  
Verify all dimensions and conditions on site and immediately notify the department representative of all discrepancies.

A	Detail No.	No. du détail
B	drawing no. - where detail required	dessin no. - où détail exigé
C	drawing no. - where detailed	dessin no. - où détaillé

project title  
titre du projet  
**PETERBOROUGH ONTARIO**

CONCRETE CANAL WALL REHABILITATION  
LOCK 23, TRENT SEVERN WATERWAY, PARKS  
CANADA AGENCY

drawing title  
titre du dessin  
**LOCK 23  
TYP. REPAIR DETAILS**

drawn by  
dessiné par  
**A.MARCZENKO**

designed by  
conc par

approved by  
approuvé par

tender  
soumission  
**DUNCAN MANSER**

project manager  
administrateur  
de projets

project date  
date du projet  
**JUNE 16, 2015**

project no.  
no. du projet  
**30025771-4272-33**

drawing no.  
dessiné no.  
**MA-06**



**RIGGS ENGINEERING Ltd.**  
 1240 COMMISSIONERS Rd. WEST  
 SUITE 205  
 LONDON, ONTARIO  
 N6K 1C7  
 (519)-657-1040  
 WWW.RIGGSENGINEERING.COM



revision		date
1	REVISED DETAILS	07/02/2015
0	ISSUED FOR TENDER	06/17/2015

Do not scale drawings. Verify all dimensions and conditions on site and immediately notify the department representative of all discrepancies.

A	Detail No.	No. du détail
B	drawing no. - where detail required	dessin no. - où détail exigé
C	drawing no. - where detailed	dessin no. - où détaillé

project title / titre du projet: **PETERBOROUGH ONTARIO**

CONCRETE CANAL WALL REHABILITATION  
 LOCK 23, TRENT SEVERN WATERWAY, PARKS CANADA AGENCY

drawing title / titre du dessin: **LOCK 23 TYP. REPAIR DETAILS**

drawn by / dessiné par: **A.MARCZENKO**

designed by / conçu par: **P.L. / W.H. / A.M.**

approved by / approuvé par: **P.LAMPKIN**

tender submission / soumission: **DUNCAN MANSER** project manager / administrateur de projets

project date / date du projet: **JUNE 16, 2015**

project no. / no. du projet: **30025771-4272-33**

drawing no. / dessin no.: **MA-07**

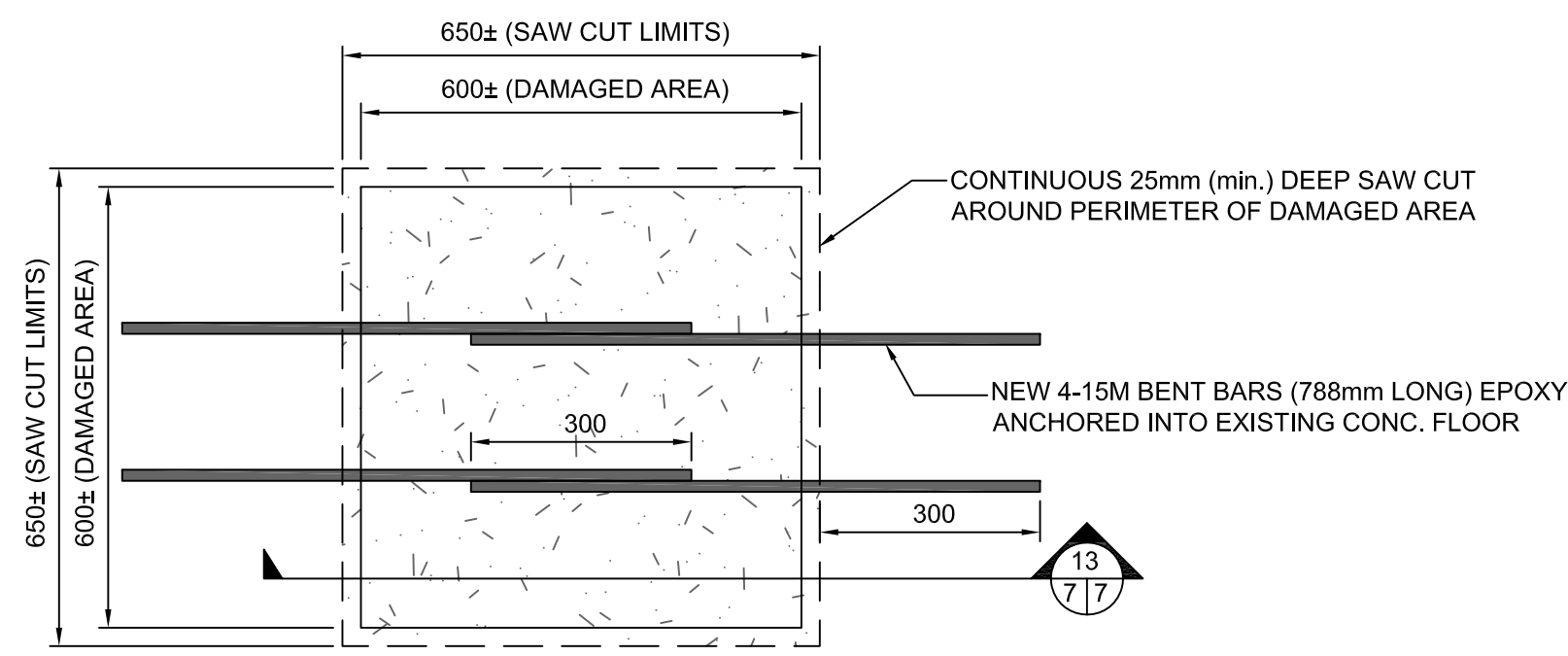

**12 PLAN VIEW OF NEW CONC. FLOOR REPAIR**  
 SCALE: 1:10

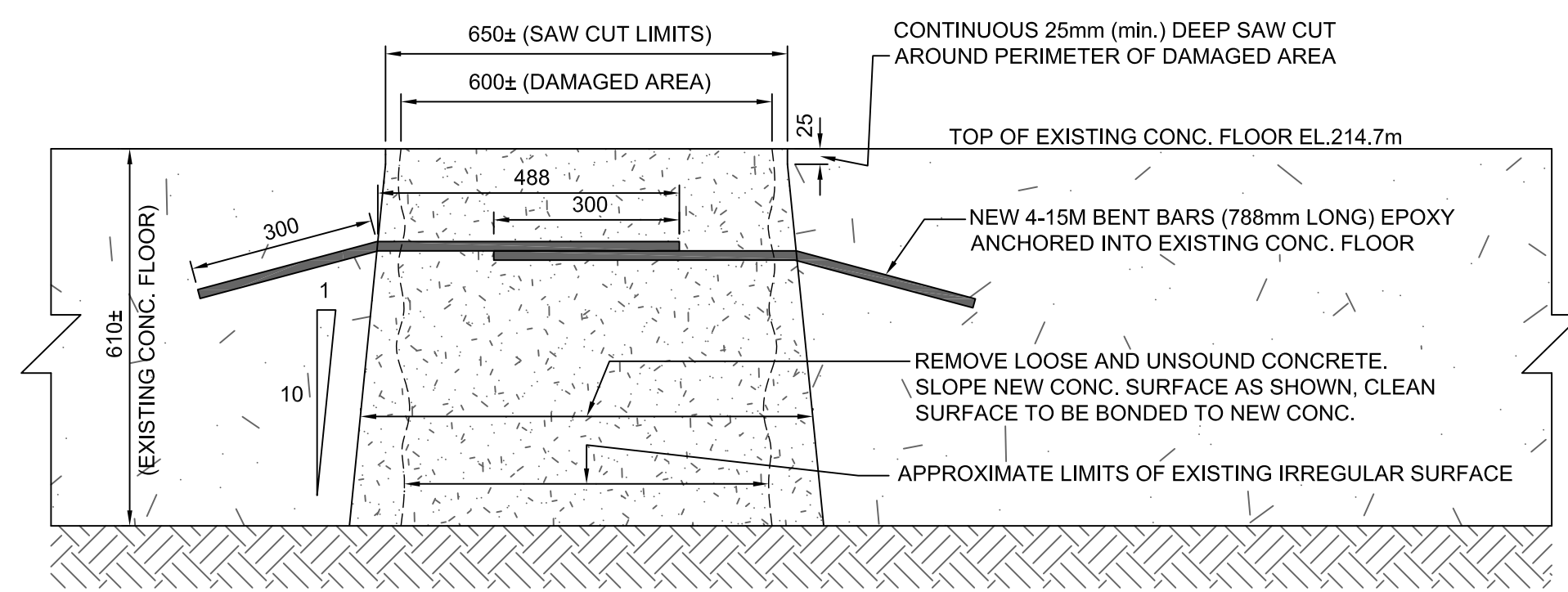

**13 TYP. SECTION OF NEW CONC. FLOOR REPAIR**  
 SCALE: 1:10

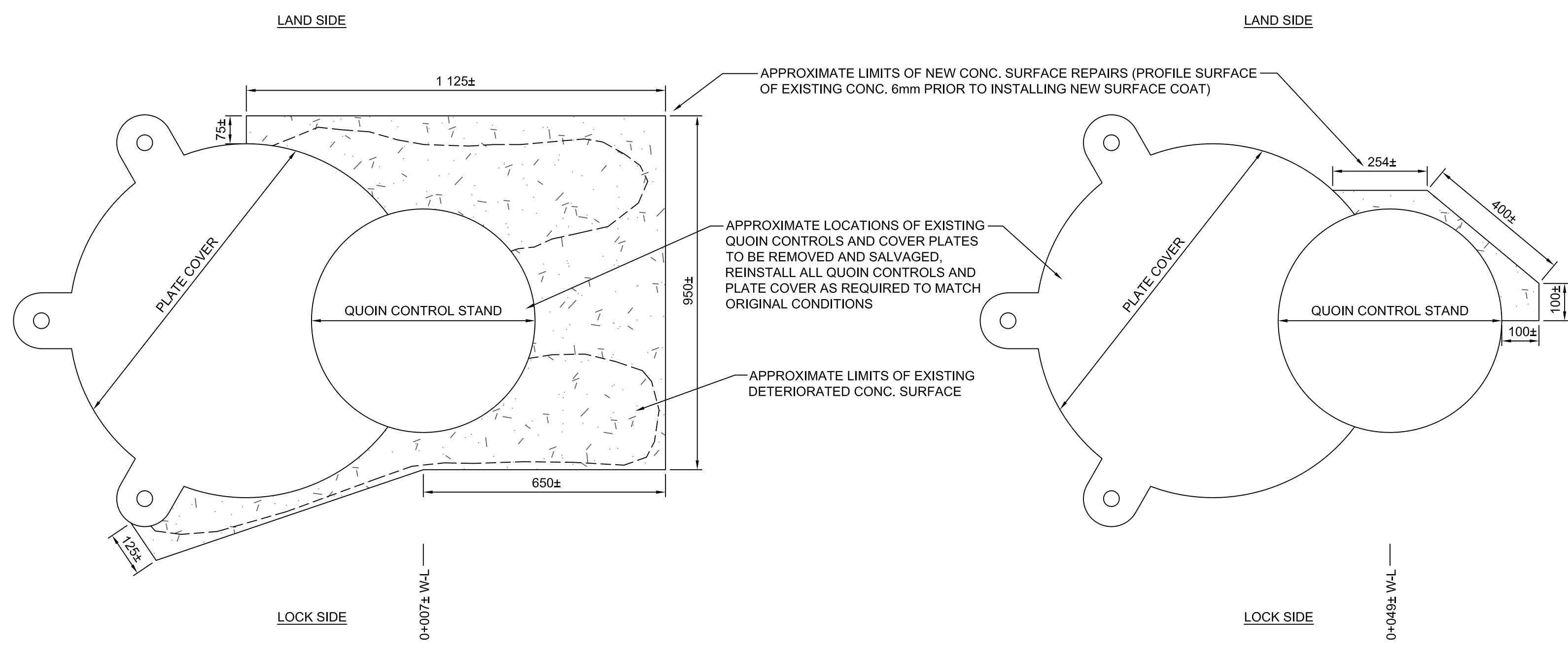

**14 TYP. SURFACE DECK REPAIR DETAIL AT QUOIN CONTROL LOCATIONS WEST SIDE - (0+007± W-L AND 0+049± W-L)**  
 SCALE: 1:10

NOTE:  
 1) EXISTING GUARDRAIL (NOT SHOWN) TO BE REMOVED AND DISPOSED. NEW GUARD RAIL TO BE INSTALLED AS SPECIFIED.  
 2) \* DIMENSIONS TO BE CONFIRMED IN THE FIELD BY CONTRACTOR PRIOR TO CONSTRUCTION.  
 3) NEW VERTICAL ACCESS PORT AND NEW 50mmØ DRAIN HOLE IS REQUIRED AT BOTH EXISTING (EAST) GATE HINGE LOCATIONS (2 TOTAL).

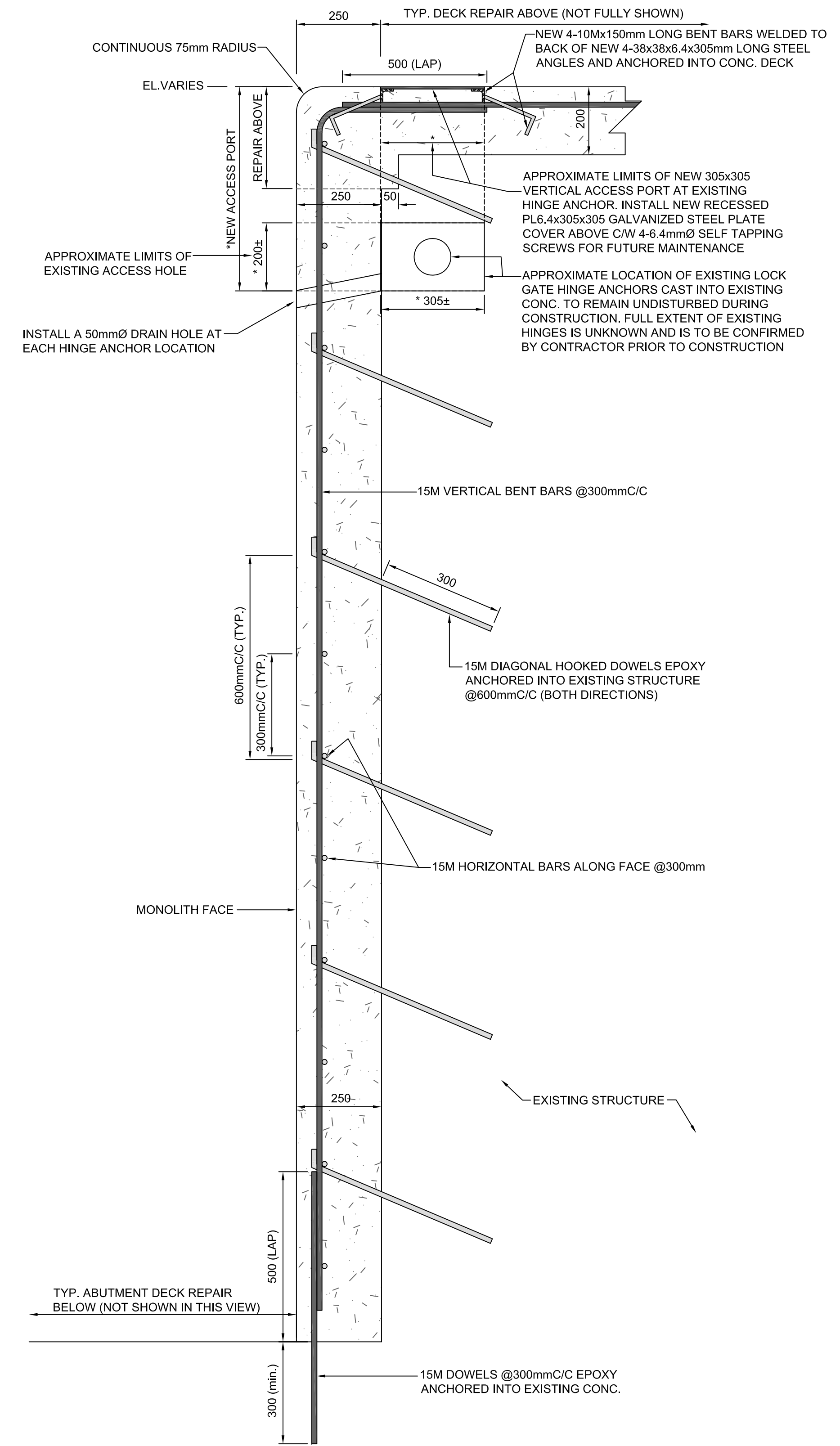

**7 MONOLITH FACE AND DECK REPAIR DETAIL EAST SIDE - (0-003.7 E-L TO 0+000 E-L)**  
 SCALE: 1:10



0 10 20 30 40 50 60 70 80 90 100 110 120 130 140 150 160 170 180 190 200 millimetres

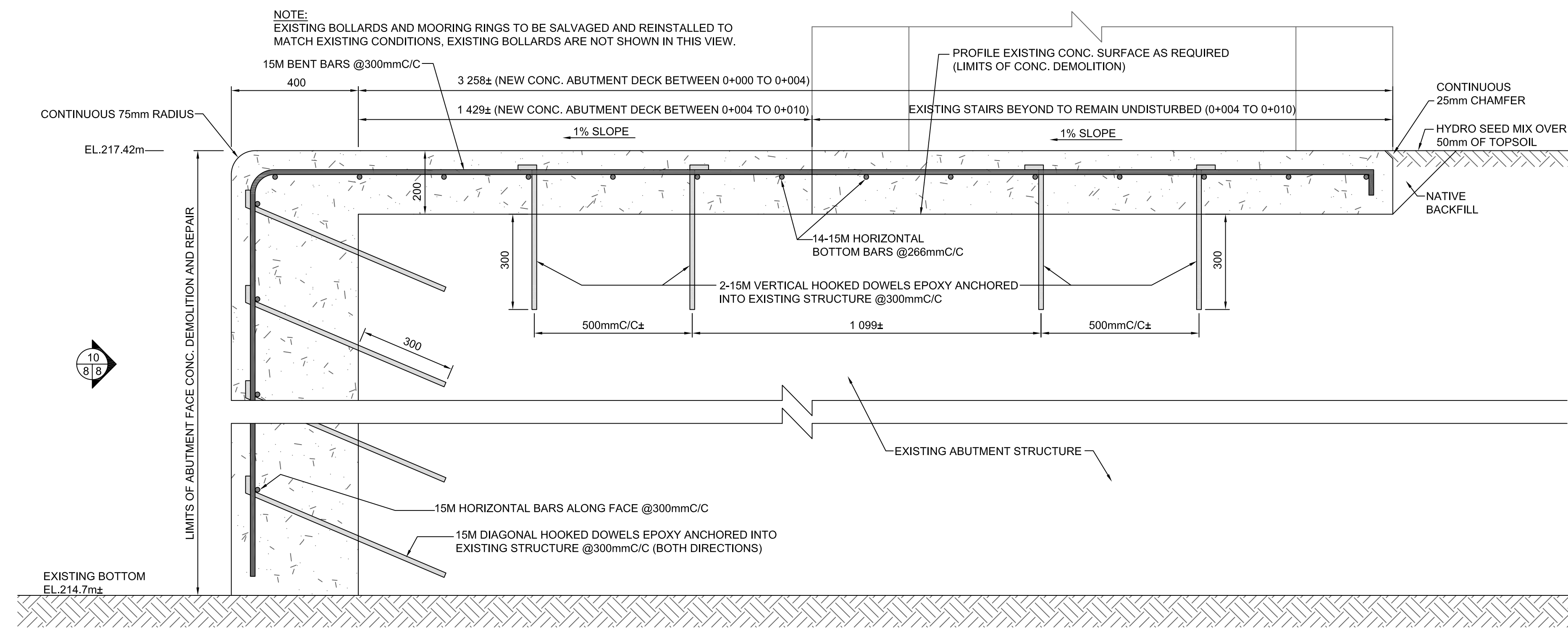

8/5/8 CONC. DECK REPAIR DETAIL EAST SIDE DOWNSTREAM - (0-000 E-DS TO 0-010.8 E-DS)  
SCALE: 1:10

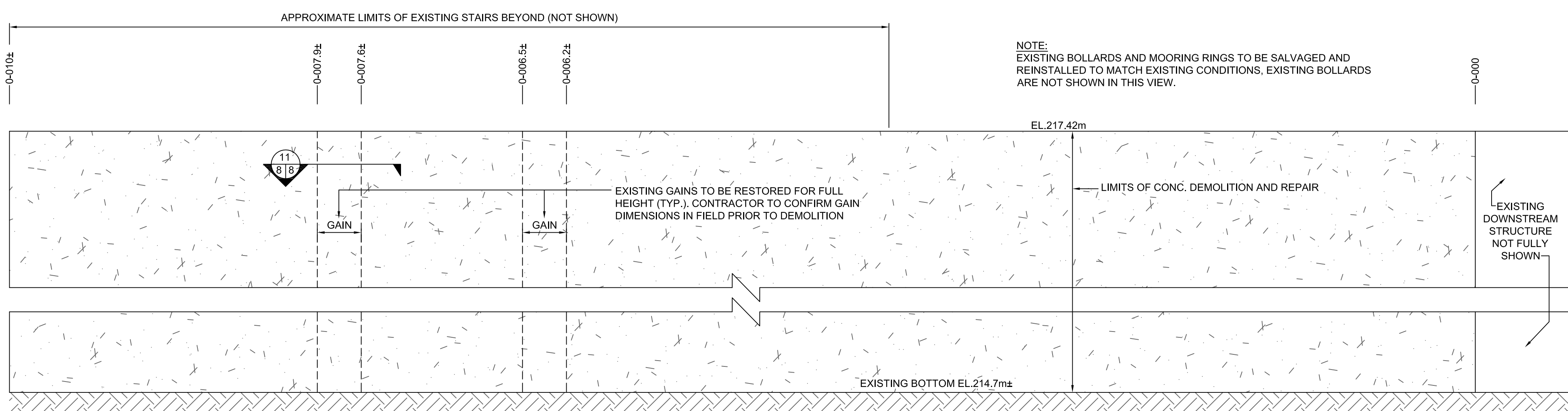

10/8/5 ELEVATION OF ABUTMENT FACE CONC. REPAIR LIMITS EAST SIDE DOWNSTREAM - (0-000 E-DS TO 0-010 E-DS)  
SCALE: 1:20

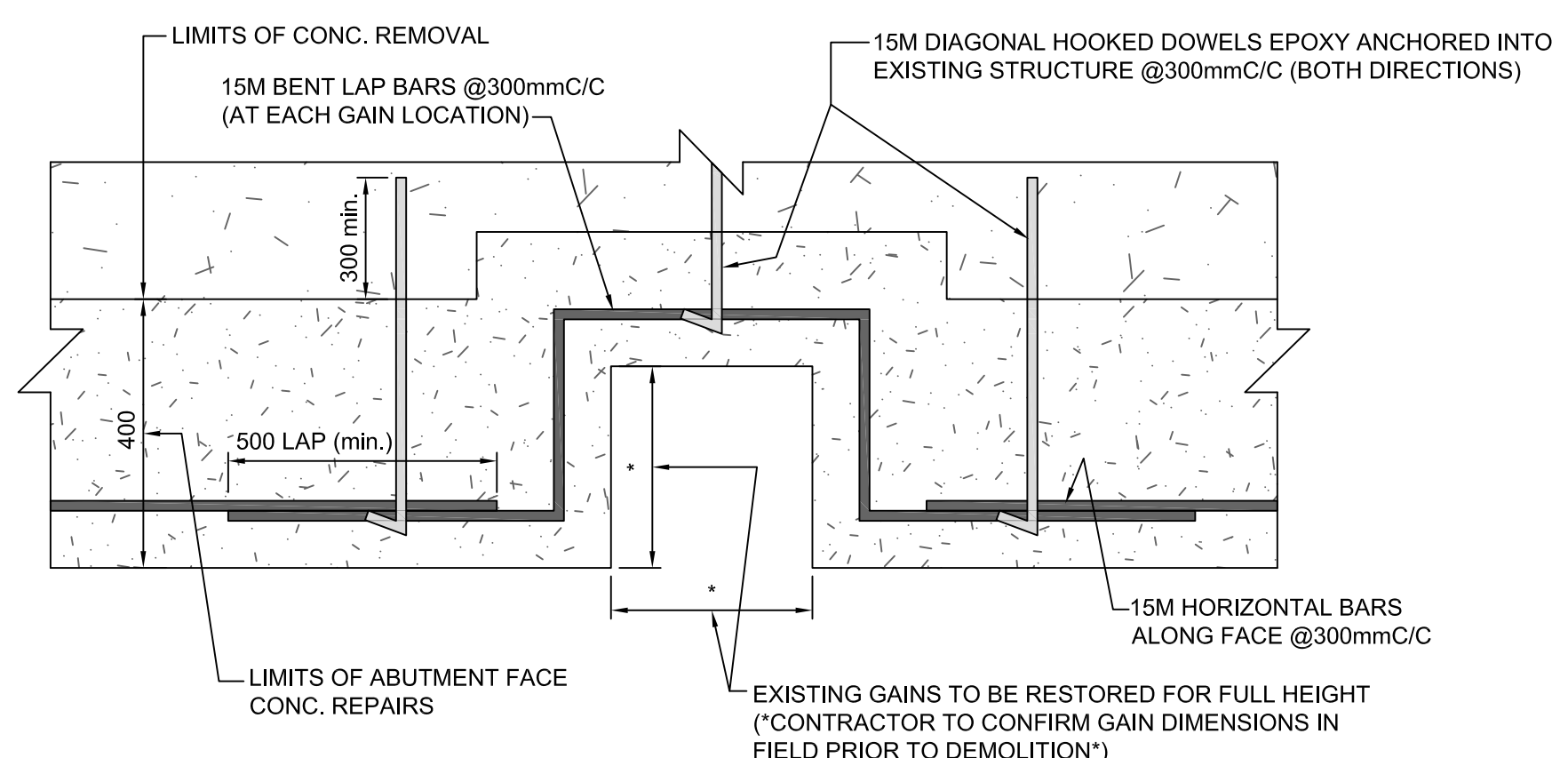

11/8/5 TYP. GAIN REBAR DETAIL  
SCALE: 1:10

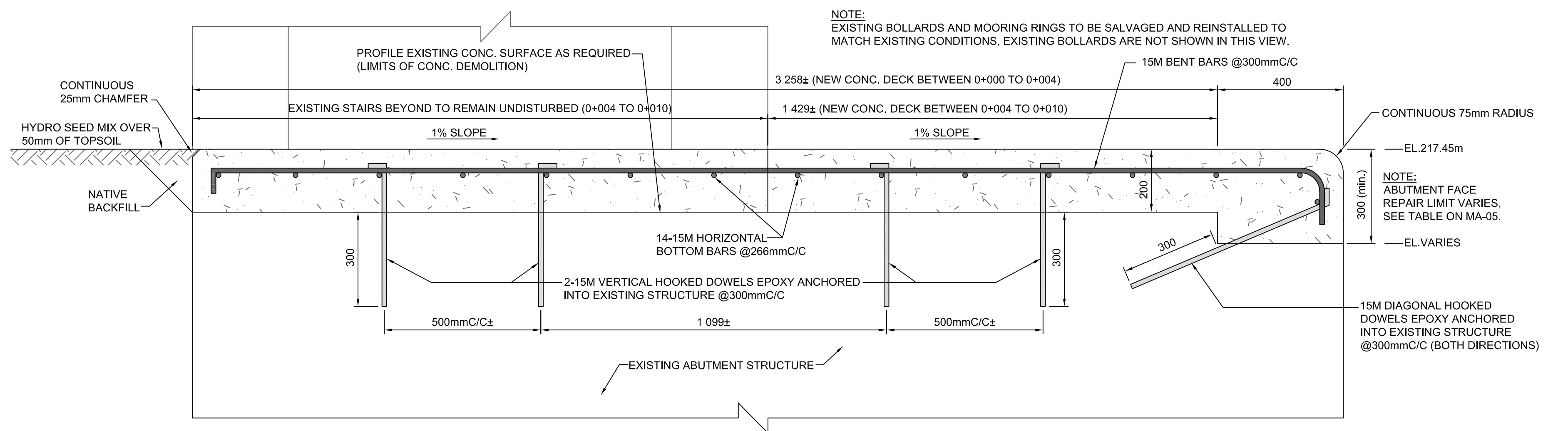

9/5/8 CONC. DECK REPAIR DETAIL WEST SIDE DOWNSTREAM - (0-000 W-DS TO 0-010.8 W-DS)  
SCALE: 1:10

TRENT SEVERN WATERWAY,  
NATIONAL HISTORIC SITE OF CANADA,  
PARKS CANADA AGENCY

**RIGGS ENGINEERING**  
RIGGS ENGINEERING Ltd.  
1240 COMMISSIONERS Rd. WEST  
SUITE 205  
LONDON, ONTARIO  
N6K 1C7  
(519)-657-1040  
WWW.RIGGSENGINEERING.COM

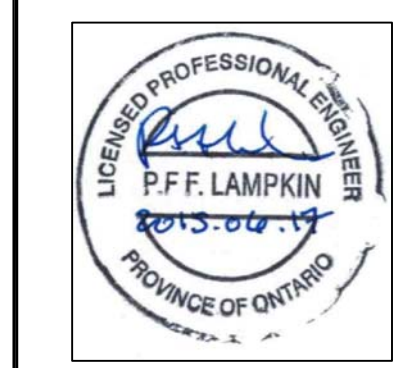

0	ISSUED FOR TENDER	06/17/2015
revision		date

Do not scale drawings.  
Verify all dimensions and conditions on site and immediately  
notify the department representative of all discrepancies.

A	Detail No.	No. du détail
B	drawing no. - where detail required	dessin no. - où détail exigé
C	drawing no. - where detailed	dessin no. - où détaillé

project title  
titre du projet  
**PETERBOROUGH ONTARIO**

CONCRETE CANAL WALL REHABILITATION  
LOCK 23, TRENT SEVERN WATERWAY, PARKS  
CANADA AGENCY

drawing title  
titre du dessin  
**LOCK 23  
TYP. REPAIR DETAILS**

drawn by  
dessiné par  
**A.MARCZENKO**

designed by  
conc par

approved by  
approuvé par

tender  
soumission  
**DUNCAN MANSER**

project manager  
administrateur  
de projets

project date  
date du projet  
**JUNE 16, 2015**

project no.  
no. du projet  
**30025771-4272-33**

drawing no.  
dessiné no.  
**MA-08**