

PANELS PARALLEL TO EXTERIOR WINDOWS ARE TO BE 36" HIGH. ALL OTHER PANELS ARE 54" MAXIMUM HIGH

A4 Portrait  
Plot Scale: 1:1

EDRM Document No.

 Public Works and  
Government Services  
Canada

Travaux publics et  
Services gouvernementaux  
Canada

designed by: \_\_\_\_\_ date: \_\_\_\_\_  
conçu par: \_\_\_\_\_

drawn by: \_\_\_\_\_  
dessiné par: \_\_\_\_\_

**WORKSTN 1**

Drawing title: \_\_\_\_\_ Titre du dessin: \_\_\_\_\_

scale: \_\_\_\_\_  
échelle: \_\_\_\_\_

date: \_\_\_\_\_ revisions: \_\_\_\_\_

approved by: \_\_\_\_\_  
approuvé par: \_\_\_\_\_

project no.: \_\_\_\_\_ no. du projet: \_\_\_\_\_

9 NOV 17

dwg no.: **W-1** dessin no.: \_\_\_\_\_



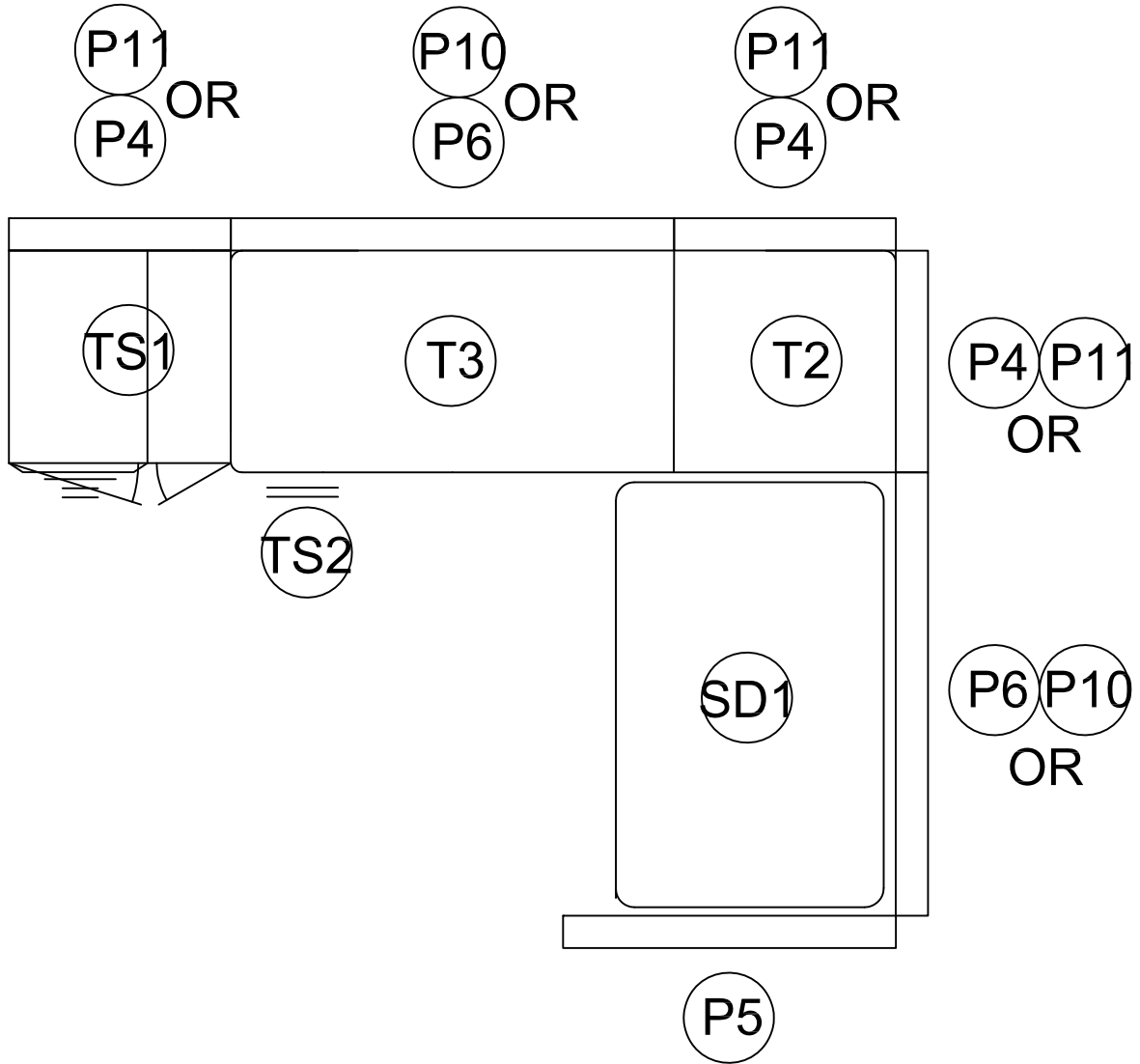

PANELS PARALLEL TO EXTERIOR WINDOWS ARE TO BE 36" HIGH. ALL OTHER PANELS ARE 54" MAXIMUM HIGH

A4 Portrait  
Plot Scale: 1:1

EDRM Document No.

 <b>Public Works and Government Services Canada</b>	<b>Travaux publics et Services gouvernementaux Canada</b>	designed by: <span style="float: right;">date:</span> conçu par:
		drawn by: <span style="float: right;">no. du projet:</span> dessiné par:
<h1>WORKSTN 3</h1>	Drawing title: <span style="float: right;">Titre du dessin:</span>	approved by: <span style="float: right;">no. du projet:</span> approuvé par:
	scale: <span style="float: right;">revisions:</span> échelle:	project no.: <span style="float: right;">no. du projet:</span>
date: <span style="float: right;">revisions:</span> 9 Nov 17	dwg no.: <b>W-3</b> <span style="float: right;">dessin no.:</span>	

P9  
P5 OR

P9  
P5 OR

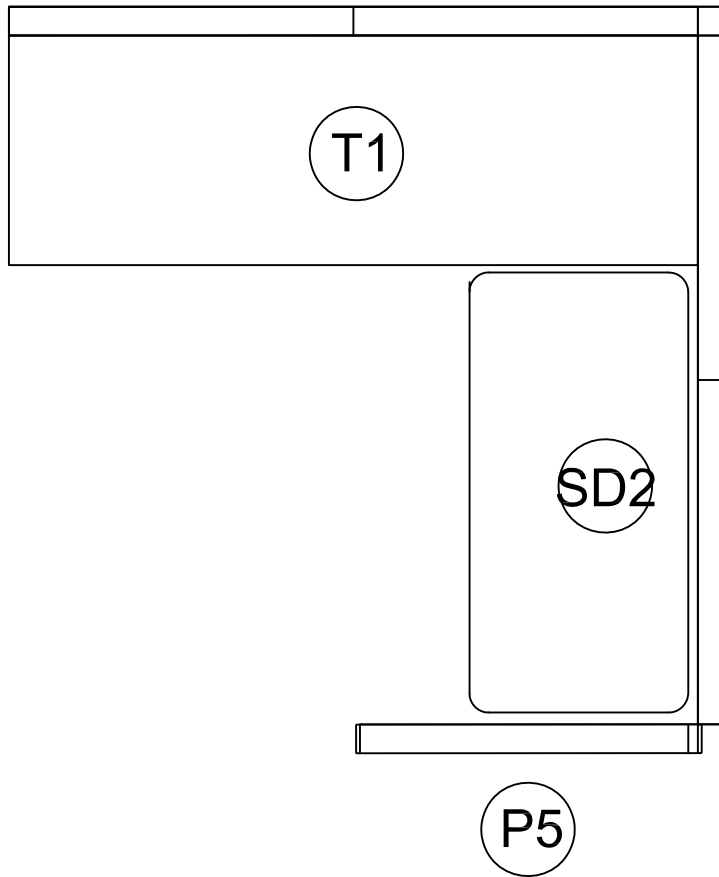

P5 P9  
OR

P5 P9  
OR

PANELS PARALLEL TO EXTERIOR WINDOWS ARE TO BE 36"  
HIGH. ALL OTHER PANELS ARE 54" MAXIMUM HIGH

A4 Portrait  
Plot Scale: 1:1

EDRM Document No.

 Public Works and  
Government Services  
Canada

Travaux publics et  
Services gouvernementaux  
Canada

designed by:                      date:  
conçu par:

drawn by:  
dessiné par:

approved by:  
approuvé par:

project no.:                      no. du projet:

**WORKSTN 4**

Drawing title:                      Titre du dessin:

scale:  
échelle:

date:                                      revisions:

dwg no.:                      dessin no.:

8 Nov 17

**W-4**

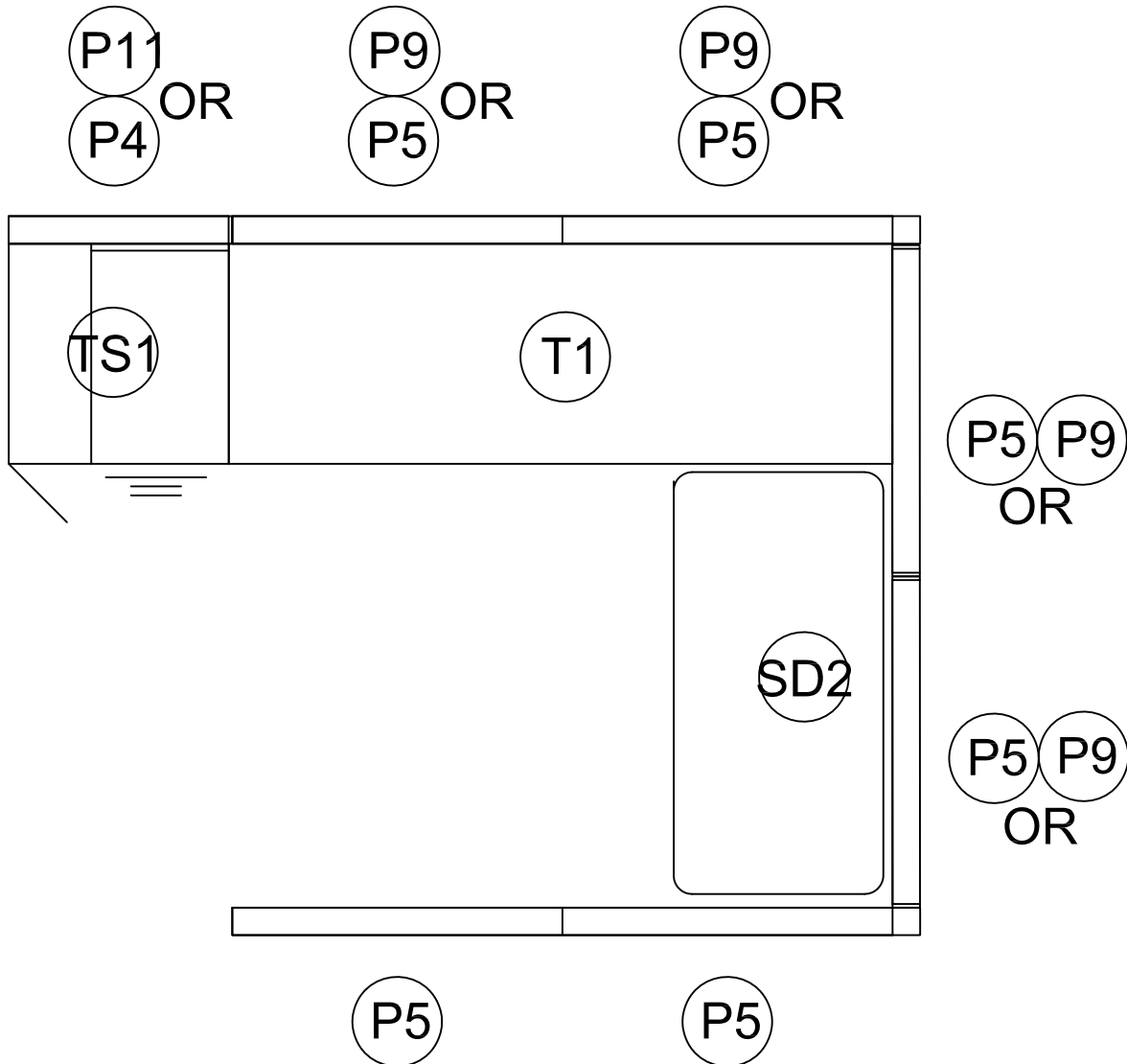

PANELS PARALLEL TO EXTERIOR WINDOWS ARE TO BE 36" HIGH. ALL OTHER PANELS ARE 54" MAXIMUM HIGH

A4 Portrait  
Plot Scale: 1:1

EDRM Document No.

 Public Works and  
Government Services  
Canada

Travaux publics et  
Services gouvernementaux  
Canada

designed by: \_\_\_\_\_ date: \_\_\_\_\_  
conçu par: \_\_\_\_\_

drawn by: \_\_\_\_\_  
dessiné par: \_\_\_\_\_

**WORKSTN 5**

Drawing title: \_\_\_\_\_ Titre du dessin: \_\_\_\_\_

scale: \_\_\_\_\_  
échelle: \_\_\_\_\_

date: \_\_\_\_\_ revisions: \_\_\_\_\_

8 Nov 17

approved by: \_\_\_\_\_  
approuvé par: \_\_\_\_\_

project no.: \_\_\_\_\_ no. du projet: \_\_\_\_\_

dwg no.: **W-5** dessin no.: \_\_\_\_\_



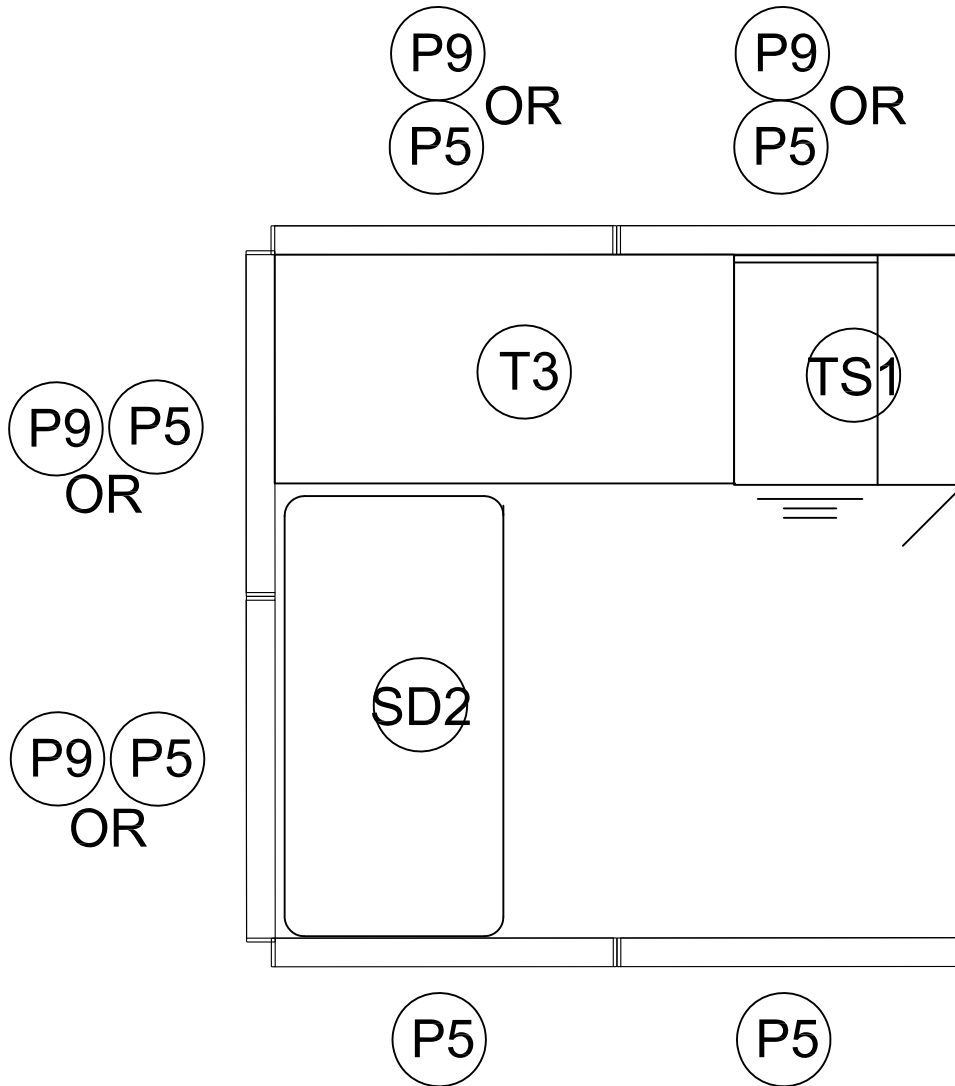

PANELS PARALLEL TO EXTERIOR WINDOWS ARE TO BE 36" HIGH. ALL OTHER PANELS ARE 54" MAXIMUM HIGH

A4 Portrait  
Plot Scale: 1:1

EDRM Document No.

 Public Works and  
Government Services  
Canada

Travaux publics et  
Services gouvernementaux  
Canada

designed by: \_\_\_\_\_ date: \_\_\_\_\_  
conçu par: \_\_\_\_\_

drawn by: \_\_\_\_\_  
dessiné par: \_\_\_\_\_

**WORKSTN 7**

Drawing title: \_\_\_\_\_ Titre du dessin: \_\_\_\_\_

scale: \_\_\_\_\_  
échelle: \_\_\_\_\_

approved by: \_\_\_\_\_  
approuvé par: \_\_\_\_\_

project no.: \_\_\_\_\_ no. du projet: \_\_\_\_\_

date: \_\_\_\_\_ revisions: \_\_\_\_\_

dwg no.: **W-7** dessin no.: \_\_\_\_\_

9 Nov 17













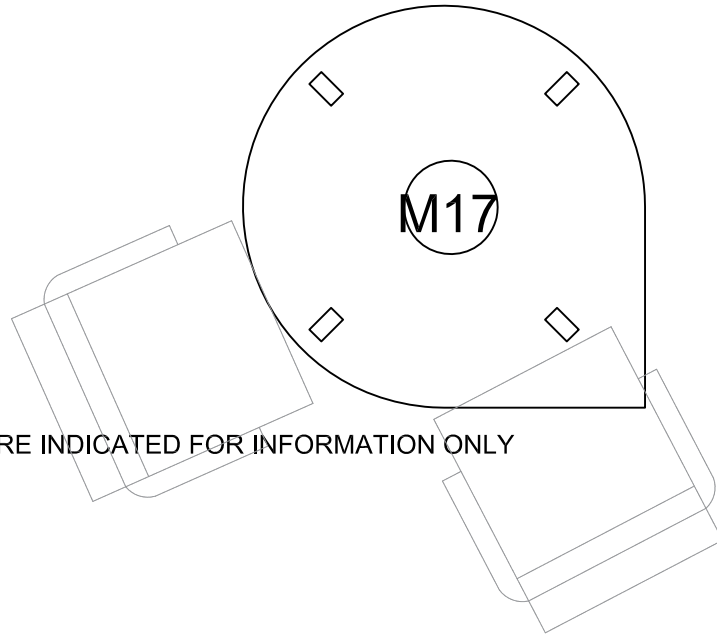
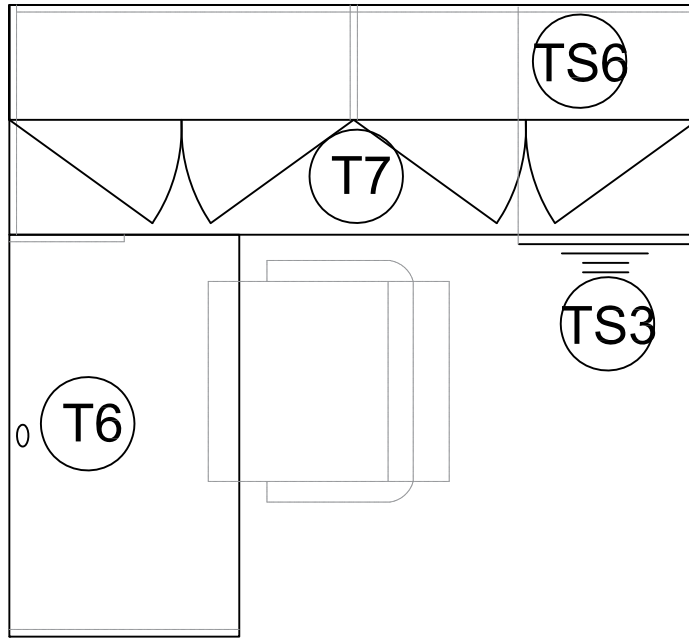

CHAIRS ARE INDICATED FOR INFORMATION ONLY

A4 Portrait  
Plot Scale: 1:1

EDRM Document No.

 Public Works and  
Government Services  
Canada

Travaux publics et  
Services gouvernementaux  
Canada

designed by: \_\_\_\_\_ date: \_\_\_\_\_  
conçu par: \_\_\_\_\_

drawn by: \_\_\_\_\_  
dessiné par: \_\_\_\_\_

**DESK 2**

Drawing title: \_\_\_\_\_ Titre du dessin: \_\_\_\_\_

scale: \_\_\_\_\_  
échelle: \_\_\_\_\_

approved by: \_\_\_\_\_  
approuvé par: \_\_\_\_\_

project no.: \_\_\_\_\_ no. du projet: \_\_\_\_\_

date: \_\_\_\_\_ revisions: \_\_\_\_\_

dwg no.: **D-2** dessin no.: \_\_\_\_\_

9 Nov 17



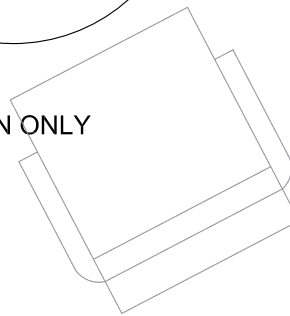
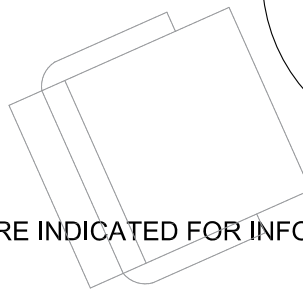
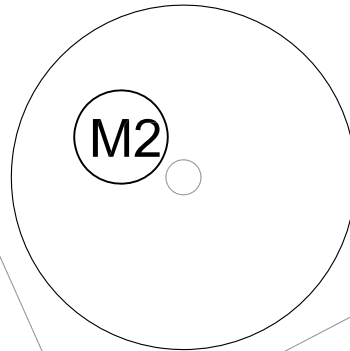
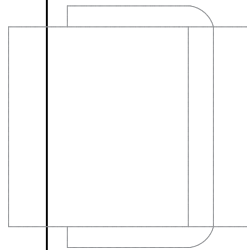
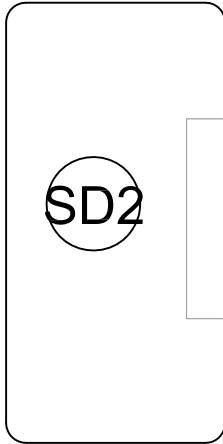
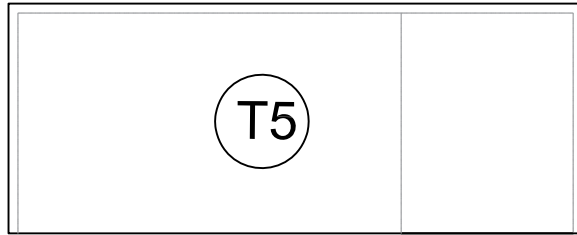

CHAIRS ARE INDICATED FOR INFORMATION ONLY

A4 Portrait  
Plot Scale: 1:1

EDRM Document No.

 Public Works and  
Government Services  
Canada

Travaux publics et  
Services gouvernementaux  
Canada

designed by:                      date:  
conçu par:

drawn by:  
dessiné par:

approved by:  
approuvé par:

project no.:                      no. du projet:

**OFFICE -DESK 4**

Drawing title:                      Titre du dessin:

scale:  
échelle:

date:                                      revisions:

dwg no.:                      dessin no.:

16 Nov 17

**D-4**

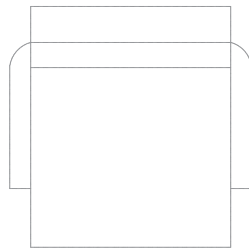

CHAIR IS INDICATED FOR SCALE AND DESIGN  
INTENT ONLY. IT IS NOT INCLUDED.

A4 Portrait  
Plot Scale: 1:1

EDRM Document No.

 Public Works and  
Government Services  
Canada

Travaux publics et  
Services gouvernementaux  
Canada

designed by:                      date:  
conçu par:

drawn by:  
dessiné par:

approved by:  
approuvé par:

project no.:                      no. du projet:

# MEETING TABLE 1

Drawing title:                      Titre du dessin:

scale:  
échelle:

date:                                      revisions:

20 NOV 17

dwg no.:                      dessin no.:

# M1









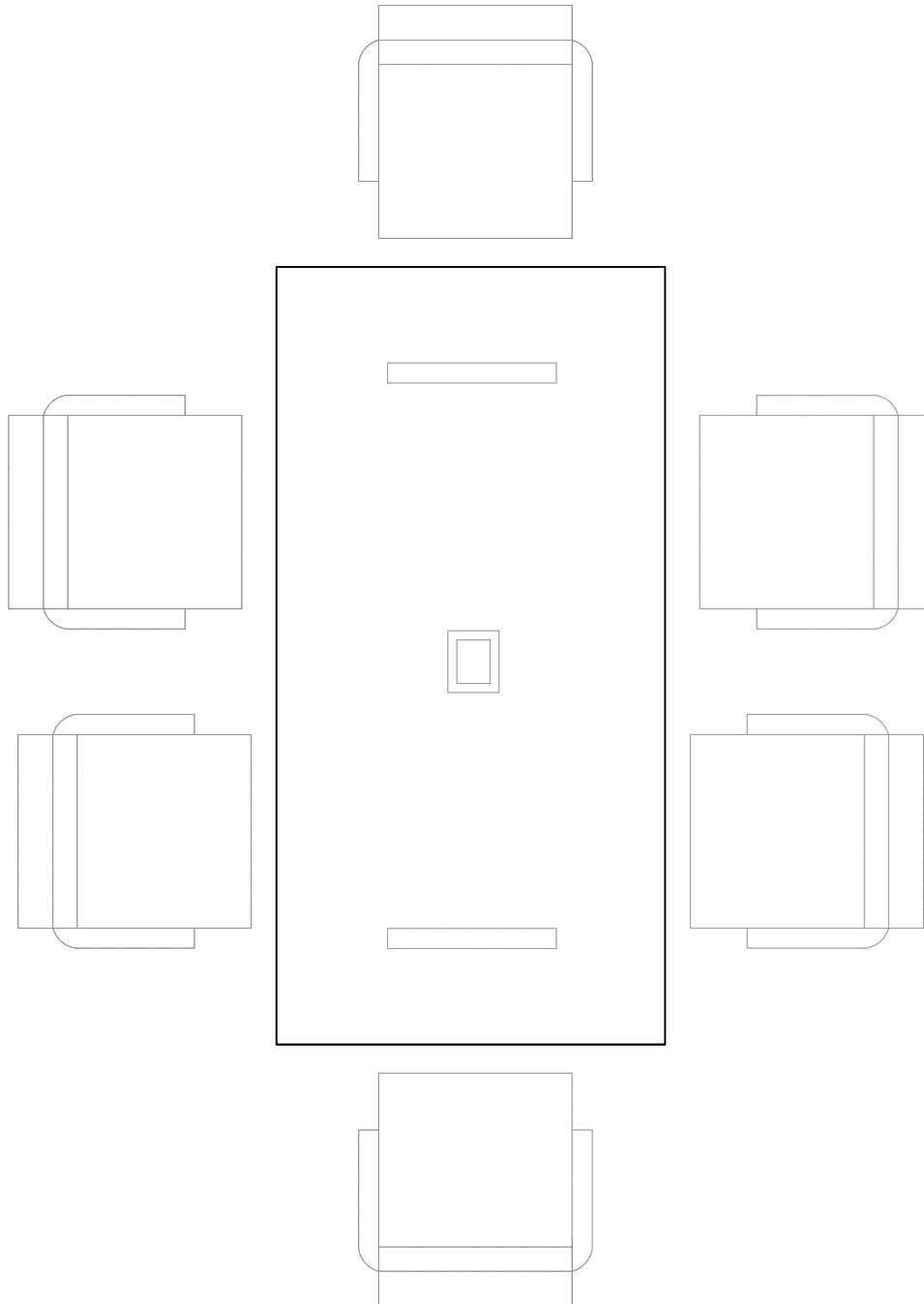

CHAIR IS INDICATED FOR SCALE AND DESIGN INTENT ONLY. IT IS NOT INCLUDED.

A4 Portrait  
Plot Scale: 1:1

EDRM Document No.

 Public Works and  
Government Services  
Canada

Travaux publics et  
Services gouvernementaux  
Canada

designed by:                      date:  
conçu par:

drawn by:  
dessiné par:

Drawing title:                      Titre du dessin:

approved by:  
approuvé par:

project no.:                      no. du projet:

scale:  
échelle:

date:

revisions:

dwg no.:

dessin no.:

9 NOV 17

**MEETING TABLE 5**

**M5**

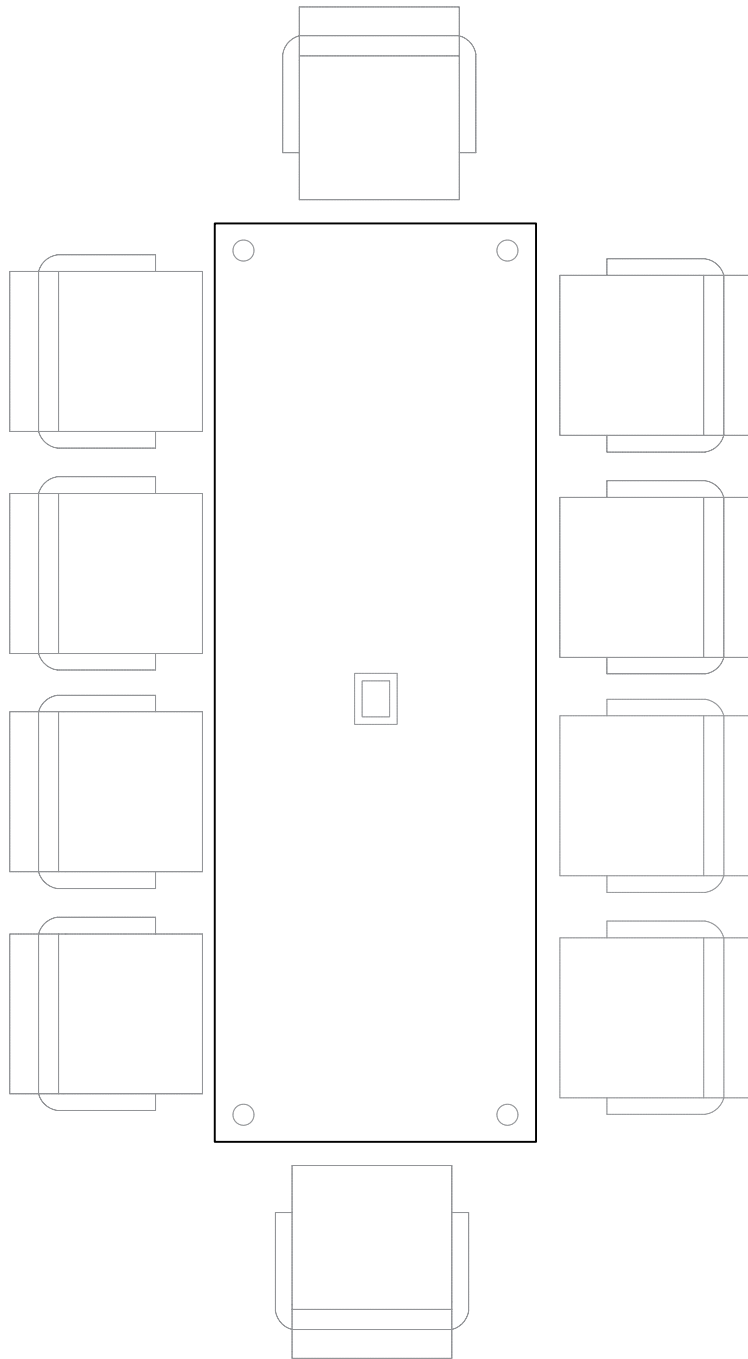

CHAIR IS INDICATED FOR SCALE AND DESIGN INTENT ONLY. IT IS NOT INCLUDED.

A4 Portrait  
Plot Scale: 1:1

EDRM Document No.

 Public Works and  
Government Services  
Canada

Travaux publics et  
Services gouvernementaux  
Canada

designed by:                      date:  
conçu par:

drawn by:  
dessiné par:

approved by:  
approuvé par:

project no.:                      no. du projet:

**MEETING TABLE 6**

Drawing title:                      Titre du dessin:

scale:  
échelle:

date:                                      revisions:

9 NOV 17

dwg no.:                      dessin no.:

**M6**

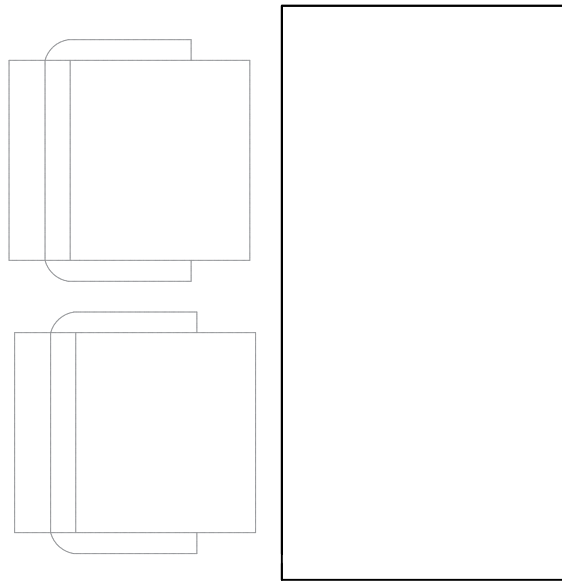

CHAIR IS INDICATED FOR SCALE AND DESIGN INTENT ONLY. IT IS NOT INCLUDED.

A4 Portrait  
Plot Scale: 1:1

EDRM Document No.

 Public Works and  
Government Services  
Canada

Travaux publics et  
Services gouvernementaux  
Canada

designed by:                      date:  
conçu par:

drawn by:  
dessiné par:

Drawing title:                      Titre du dessin:

approved by:  
approuvé par:

project no.:                      no. du projet:

**MEETING TABLE 7**

scale:  
échelle:

date:

revisions:

dwg no.:

dessin no.:

9 NOV 17

**M7**

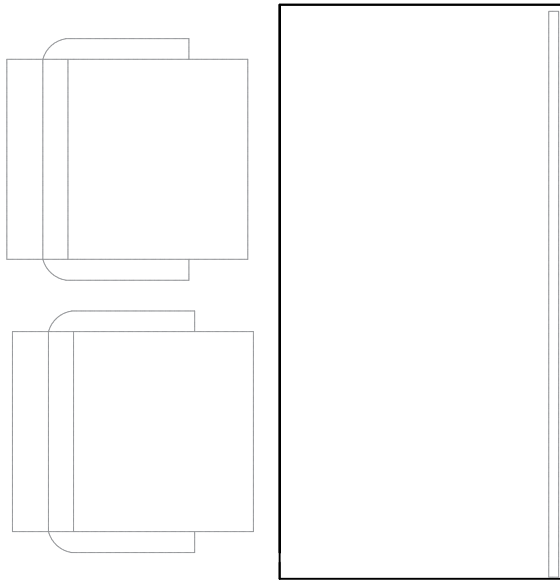

CHAIR IS INDICATED FOR SCALE AND DESIGN INTENT ONLY. IT IS NOT INCLUDED.

A4 Portrait  
Plot Scale: 1:1

EDRM Document No.

 Public Works and  
Government Services  
Canada

Travaux publics et  
Services gouvernementaux  
Canada

designed by:                      date:  
conçu par:

drawn by:  
dessiné par:

Drawing title:                      Titre du dessin:

approved by:  
approuvé par:

project no.:                      no. du projet:

**MEETING TABLE 8**

scale:  
échelle:

date:

revisions:

dwg no.:

dessin no.:

9 NOV 17

**M8**





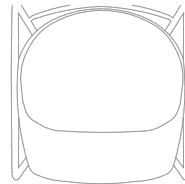
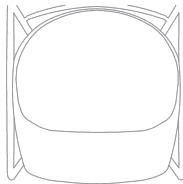
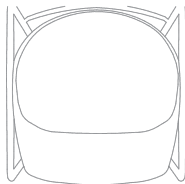
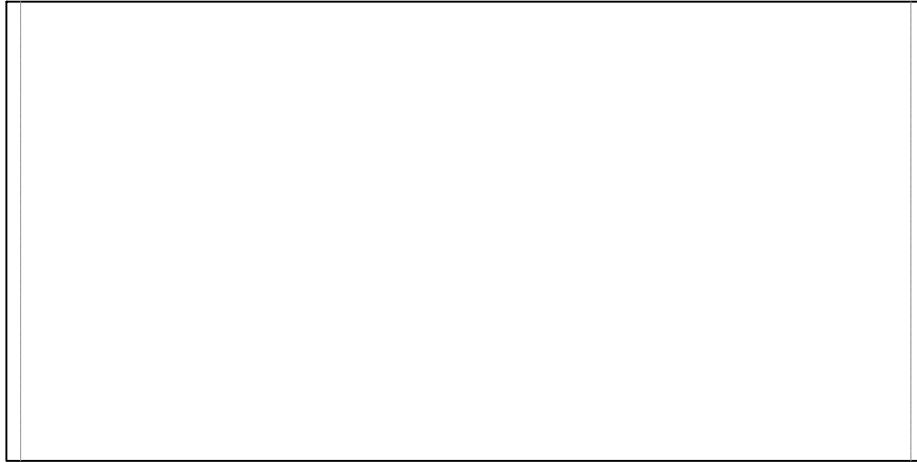
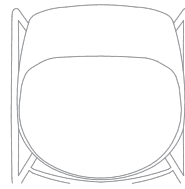
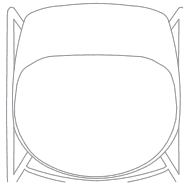
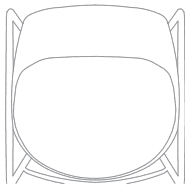

CHAIR IS INDICATED FOR SCALE AND DESIGN  
INTENT ONLY. IT IS NOT INCLUDED.

A4 Portrait  
Plot Scale: 1:1

EDRM Document No.

 Public Works and  
Government Services  
Canada

Travaux publics et  
Services gouvernementaux  
Canada

designed by:                      date:  
conçu par:

drawn by:  
dessiné par:

approved by:  
approuvé par:

project no.:                      no. du projet:

**MEETING TABLE 10**

Drawing title:                      Titre du dessin:

scale:  
échelle:

date:                                      revisions:

9 NOV 17

dwg no.:                      dessin no.:

**M10**



A4 Portrait  
Plot Scale: 1:1

EDRM Document No.

 Public Works and  
Government Services  
Canada

Travaux publics et  
Services gouvernementaux  
Canada

designed by:                      date:  
conçu par:

drawn by:  
dessiné par:

Drawing title:                      Titre du dessin:

approved by:  
approuvé par:

project no.:                      no. du projet:

**MEETING TABLE 11**

scale:  
échelle:

date:

revisions:

9 NOV 17

dwg no.:                      dessin no.:

**M11**

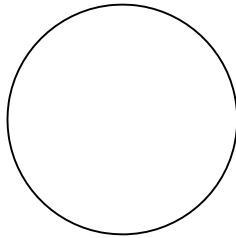

A4 Portrait  
Plot Scale: 1:1

EDRM Document No.

 Public Works and  
Government Services  
Canada

Travaux publics et  
Services gouvernementaux  
Canada

designed by:                      date:  
conçu par:

drawn by:  
dessiné par:

Drawing title:                      Titre du dessin:

approved by:  
approuvé par:

project no.:                      no. du projet:

# MEETING TABLE 12

scale:  
échelle:

date:

revisions:

9 NOV 17

dwg no.:                      dessin no.:

# M12

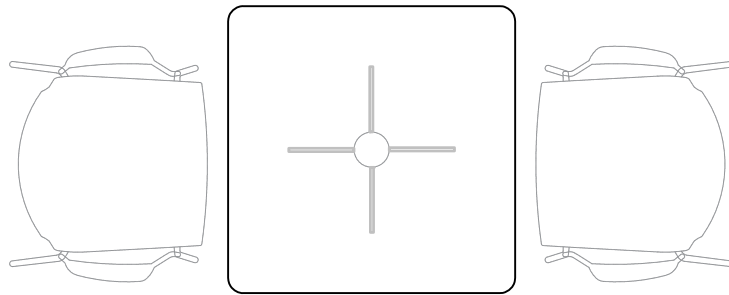

CHAIR IS INDICATED FOR SCALE AND DESIGN  
INTENT ONLY. IT IS NOT INCLUDED.

A4 Portrait  
Plot Scale: 1:1

EDRM Document No.

 Public Works and  
Government Services  
Canada

Travaux publics et  
Services gouvernementaux  
Canada

designed by:                      date:  
conçu par:

drawn by:  
dessiné par:

approved by:  
approuvé par:

project no.:                      no. du projet:

**MEETING TABLE 13**

Drawing title:                      Titre du dessin:

scale:  
échelle:

date:

revisions:

9 NOV 17

dwg no.:                      dessin no.:

**M13**

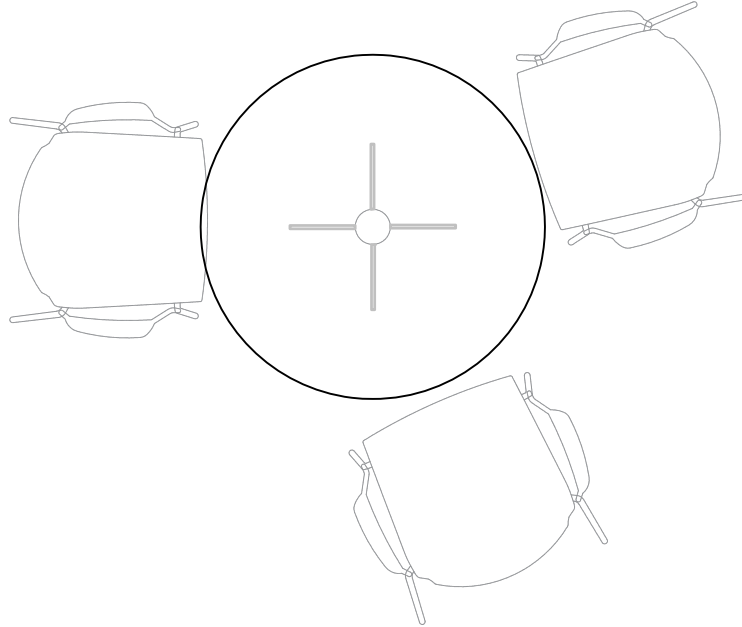

CHAIR IS INDICATED FOR SCALE AND DESIGN INTENT ONLY. IT IS NOT INCLUDED.

A4 Portrait  
Plot Scale: 1:1

EDRM Document No.

 Public Works and  
Government Services  
Canada

Travaux publics et  
Services gouvernementaux  
Canada

designed by:                      date:  
conçu par:

drawn by:  
dessiné par:

approved by:  
approuvé par:

project no.:                      no. du projet:

**MEETING TABLE 14**

Drawing title:                      Titre du dessin:

scale:  
échelle:

date:

revisions:

9 NOV 17

dwg no.:                      dessin no.:

**M14**

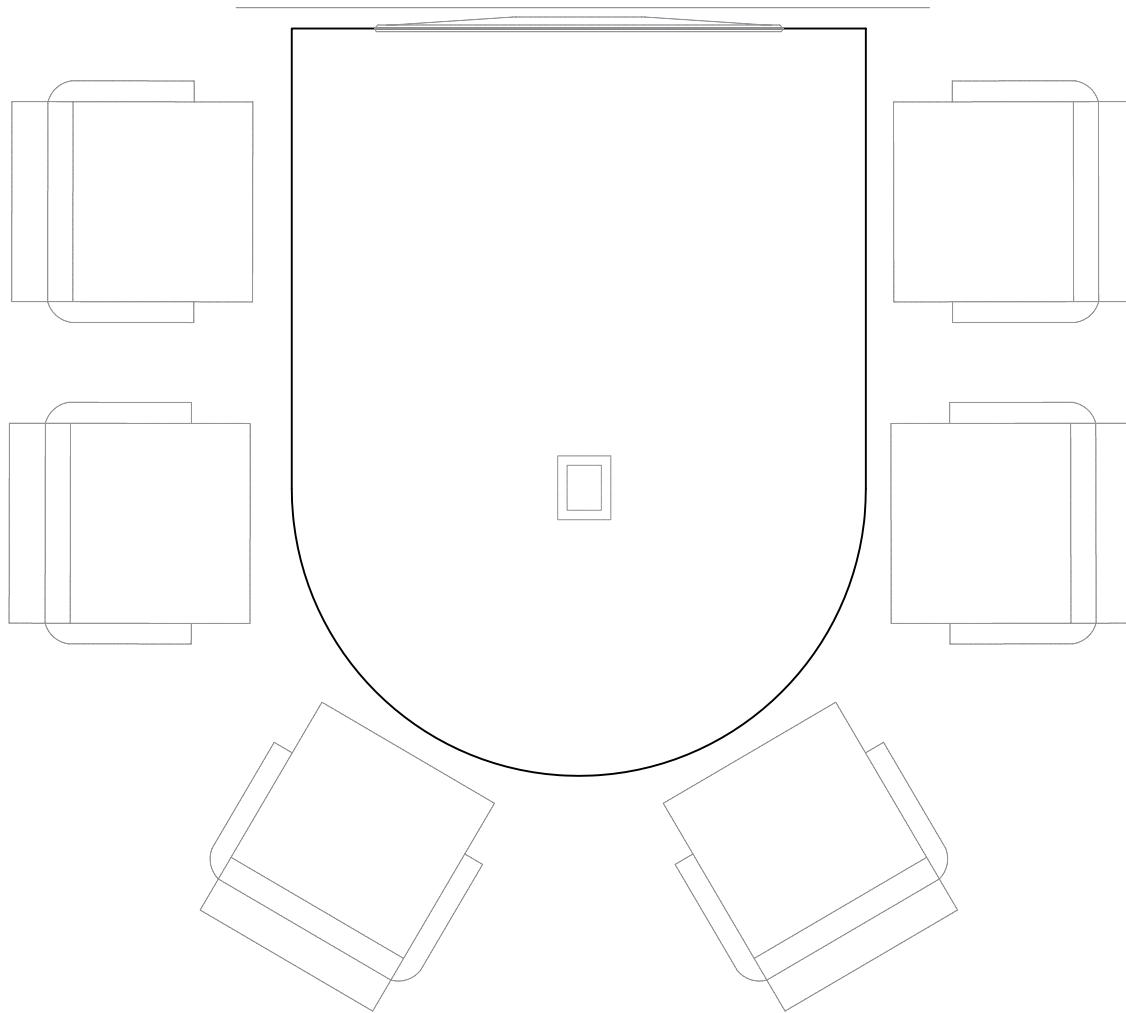

CHAIR AND MONITOR ARE INDICATED FOR SCALE AND DESIGN INTENT ONLY. THEY ARE NOT INCLUDED.

A4 Portrait  
Plot Scale: 1:1

EDRM Document No.

 Public Works and  
Government Services  
Canada

Travaux publics et  
Services gouvernementaux  
Canada

designed by:                      date:  
conçu par:

drawn by:  
dessiné par:

approved by:  
approuvé par:

project no.:                      no. du projet:

dwg no.:                      dessin no.:

**MEETING TABLE 15**

Drawing title:                      Titre du dessin:

scale:  
échelle:

date:

revisions:

9 NOV 17

**M15**

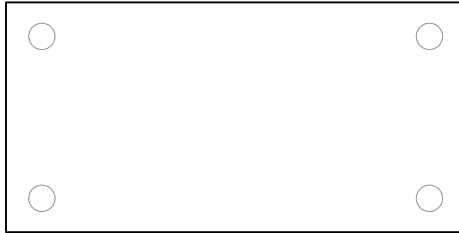

A4 Portrait  
Plot Scale: 1:1

EDRM Document No.

 Public Works and  
Government Services  
Canada

Travaux publics et  
Services gouvernementaux  
Canada

designed by:                      date:  
conçu par:

drawn by:  
dessiné par:

Drawing title:                      Titre du dessin:

approved by:  
approuvé par:

project no.:                      no. du projet:

**MEETING TABLE 16**

scale:  
échelle:

date:

revisions:

20 NOV 17

dwg no.:                      dessin no.:

**M16**

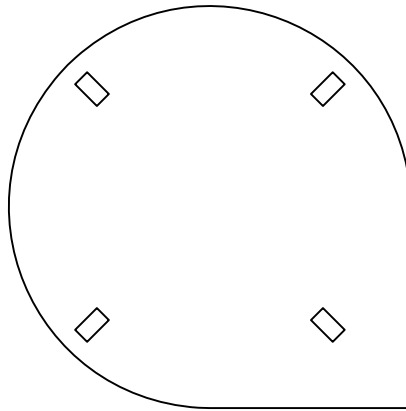

A4 Portrait  
Plot Scale: 1:1

EDRM Document No.

 Public Works and  
Government Services  
Canada

Travaux publics et  
Services gouvernementaux  
Canada

designed by:                      date:  
conçu par:

drawn by:  
dessiné par:

Drawing title:                      Titre du dessin:

approved by:  
approuvé par:

project no.:                      no. du projet:

**MEETING TABLE 17**

scale:  
échelle:

date:

revisions:

dwg no.:                      dessin no.:

20 NOV 17

**M17**



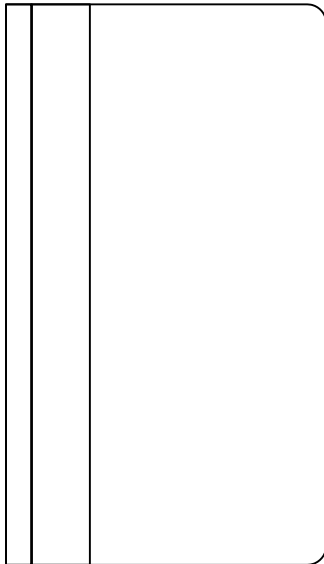

A4 Portrait  
Plot Scale: 1:1

EDRM Document No.

 Public Works and  
Government Services  
Canada

Travaux publics et  
Services gouvernementaux  
Canada

designed by:                      date:  
conçu par:

drawn by:  
dessiné par:

# COLLABORATION 1

Drawing title:                      Titre du dessin:

approved by:  
approuvé par:

project no.:                      no. du projet:

scale:  
échelle:

date:

revisions:

dwg no.:

# C-1

dessin no.:

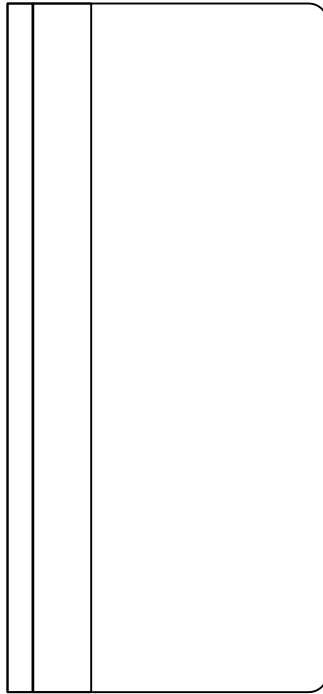

A4 Portrait  
Plot Scale: 1:1

EDRM Document No.

 Public Works and  
Government Services  
Canada

Travaux publics et  
Services gouvernementaux  
Canada

designed by:                      date:  
conçu par:

drawn by:  
dessiné par:

approved by:  
approuvé par:

project no.:                      no. du projet:

# COLLABORATION 2

Drawing title:                      Titre du dessin:

scale:  
échelle:

date:                                      revisions:

dwg no.:                      dessin no.:

## C-2

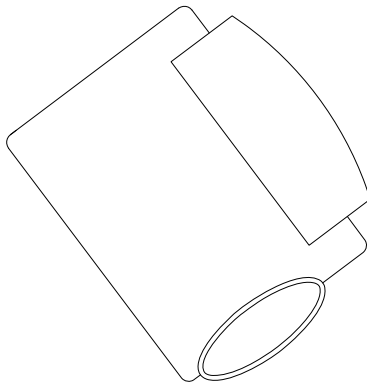

A4 Portrait  
Plot Scale: 1:1

EDRM Document No.

 Public Works and  
Government Services  
Canada

Travaux publics et  
Services gouvernementaux  
Canada

designed by:                      date:  
conçu par:

drawn by:  
dessiné par:

approved by:  
approuvé par:

project no.:                      no. du projet:

# COLLABORATION 3

Drawing title:                      Titre du dessin:

scale:  
échelle:

date:                                      revisions:

dwg no.:                      dessin no.:

## C-3

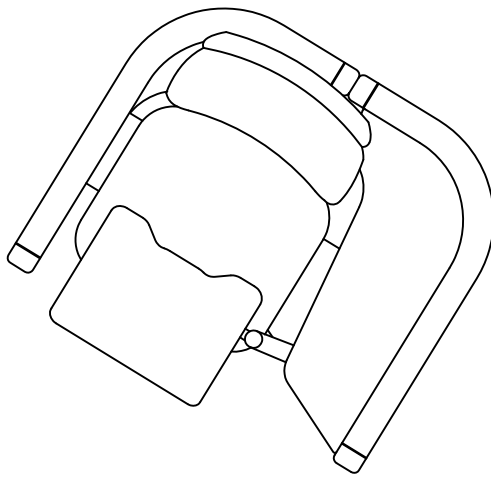

A4 Portrait  
Plot Scale: 1:1

EDRM Document No.

 Public Works and  
Government Services  
Canada

Travaux publics et  
Services gouvernementaux  
Canada

designed by:                      date:  
conçu par:

drawn by:  
dessiné par:

approved by:  
approuvé par:

project no.:                      no. du projet:

# COLLABORATION 4

Drawing title:                      Titre du dessin:

scale:  
échelle:

date:

revisions:

dwg no.:

# C-4

dessin no.:

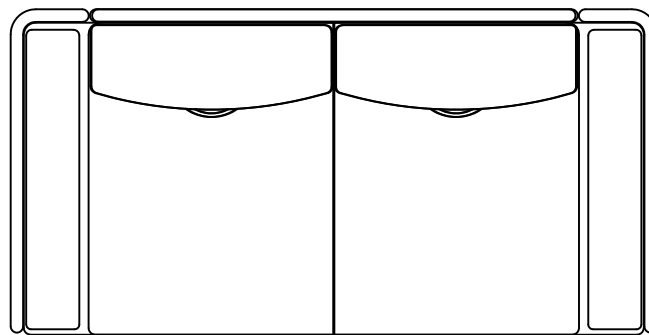

A4 Portrait  
Plot Scale: 1:1

EDRM Document No.

 Public Works and  
Government Services  
Canada

Travaux publics et  
Services gouvernementaux  
Canada

designed by:                      date:  
conçu par:

drawn by:  
dessiné par:

approved by:  
approuvé par:

project no.:                      no. du projet:

# COLLABORATION 5

Drawing title:                      Titre du dessin:

scale:  
échelle:

date:                                      revisions:

dwg no.:                      dessin no.:

## C-5

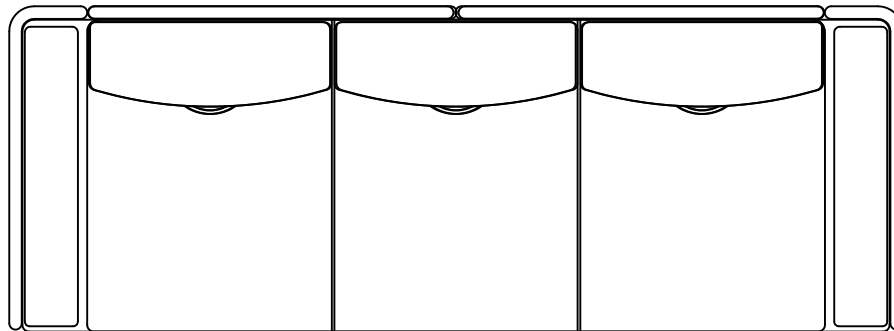

A4 Portrait  
Plot Scale: 1:1

EDRM Document No.

 Public Works and  
Government Services  
Canada

Travaux publics et  
Services gouvernementaux  
Canada

designed by:                      date:  
conçu par:

drawn by:  
dessiné par:

approved by:  
approuvé par:

project no.:                      no. du projet:

# COLLABORATION 6

Drawing title:                      Titre du dessin:

scale:  
échelle:

date:                                      revisions:

dwg no.:                      dessin no.:

## C-6

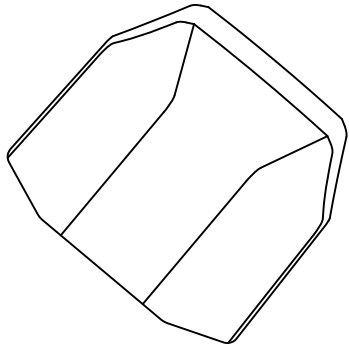

A4 Portrait  
Plot Scale: 1:1

EDRM Document No.

 Public Works and  
Government Services  
Canada

Travaux publics et  
Services gouvernementaux  
Canada

designed by:                      date:  
conçu par:

drawn by:  
dessiné par:

approved by:  
approuvé par:

project no.:                      no. du projet:

# COLLABORATION 7

Drawing title:                      Titre du dessin:

scale:  
échelle:

date:

revisions:

dwg no.:                      dessin no.:

## C-7