

5		
4		
3		
2	ISSUED FOR TENDER	MAY/19
1	ISSUED FOR DESIGN 66% REVIEW	MAR/19
revisions	description	date

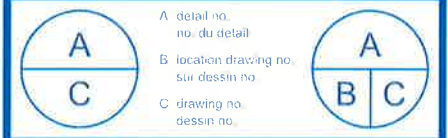

project projet
PACIFIC WILDLIFE RESEARCH CENTRE
 542 ROBERTSON ROAD
 DELTA, BC, V4K 3N2

drawing dessin
**ROOF REPLACEMENT
 ROOF PLAN**

Designed By	IRC GROUP	Conçu par
Date	2019/03/25	(yyyy/mm/dd)
Drawn By	IRC GROUP	Dessiné par
Date	2019/03/25	(yyyy/mm/dd)
Reviewed By		Examiné par
Date		(yyyy/mm/dd)
Approved By		Approuvé par
Date		(yyyy/mm/dd)
Tender		Soumission

Project Manager	Administrateur de projets
IC Proj no.	Consultant Proj no.
Drawing no.	No. du dessin
	A1

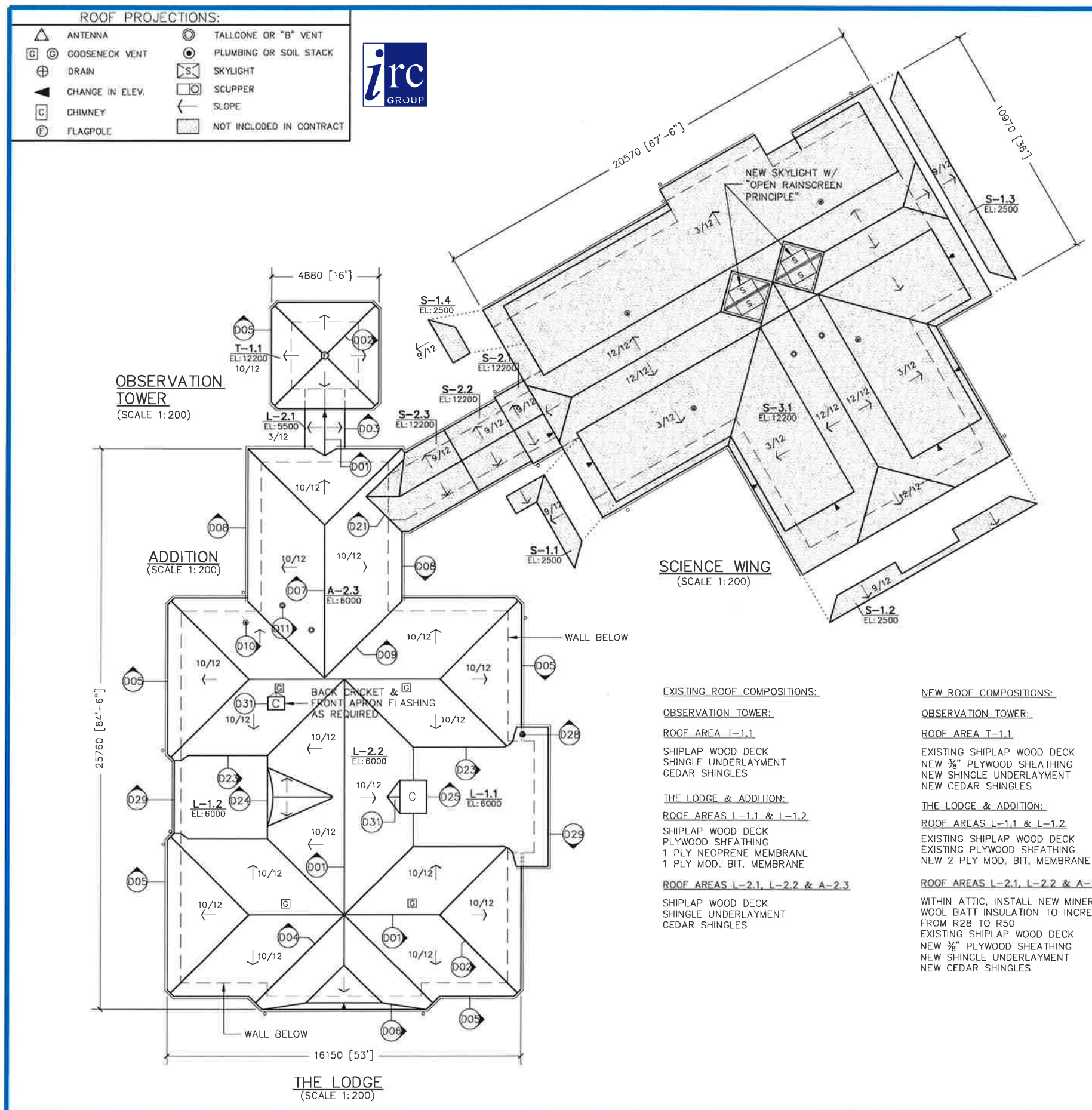

Plotted by: BWANG May 08, 2019 - 1:04pm



Environment Canada
Environnement Canada



IRC Building Sciences Group
Le Groupe IRC

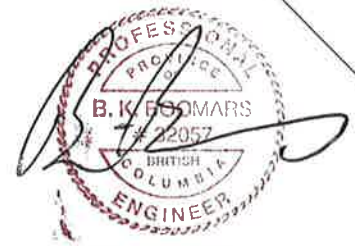
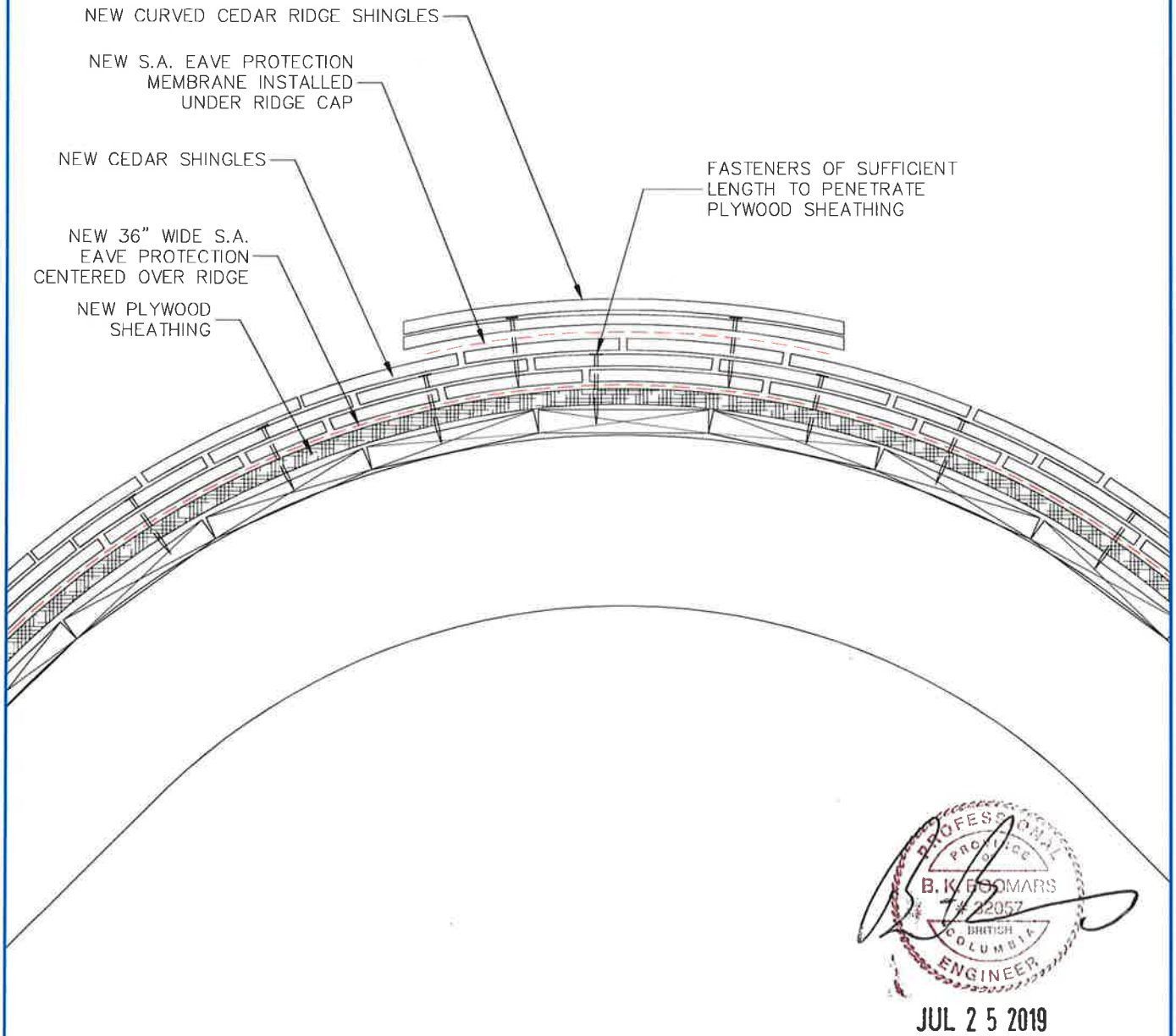

JUL 2 5 2019

Project Title		Drawing title		
ROOF REPLACEMENT PACIFIC WILDLIFE RESEARCH CENTRE 5241 ROBERTSON ROAD, DETAIL, BC		CURVED RIDGE DETAIL		
Designed By	IRC GROUP	Approved By	Scale	1:5
Drawn By	IRC GROUP	Date	Date	
Reviewed By		Tender	MAR 29/19	
Date		Project Manager	EC Project no.	Consultant Project No. VR18-117SP-21476
			Drawing no.	D01
			Revision/Revision	0



Environment Canada
Environnement Canada



IRC Building Sciences Group
Le Groupe IRC

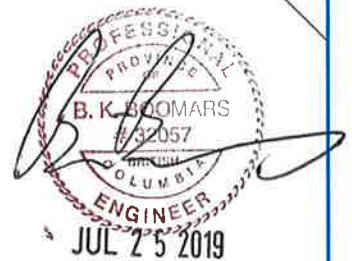
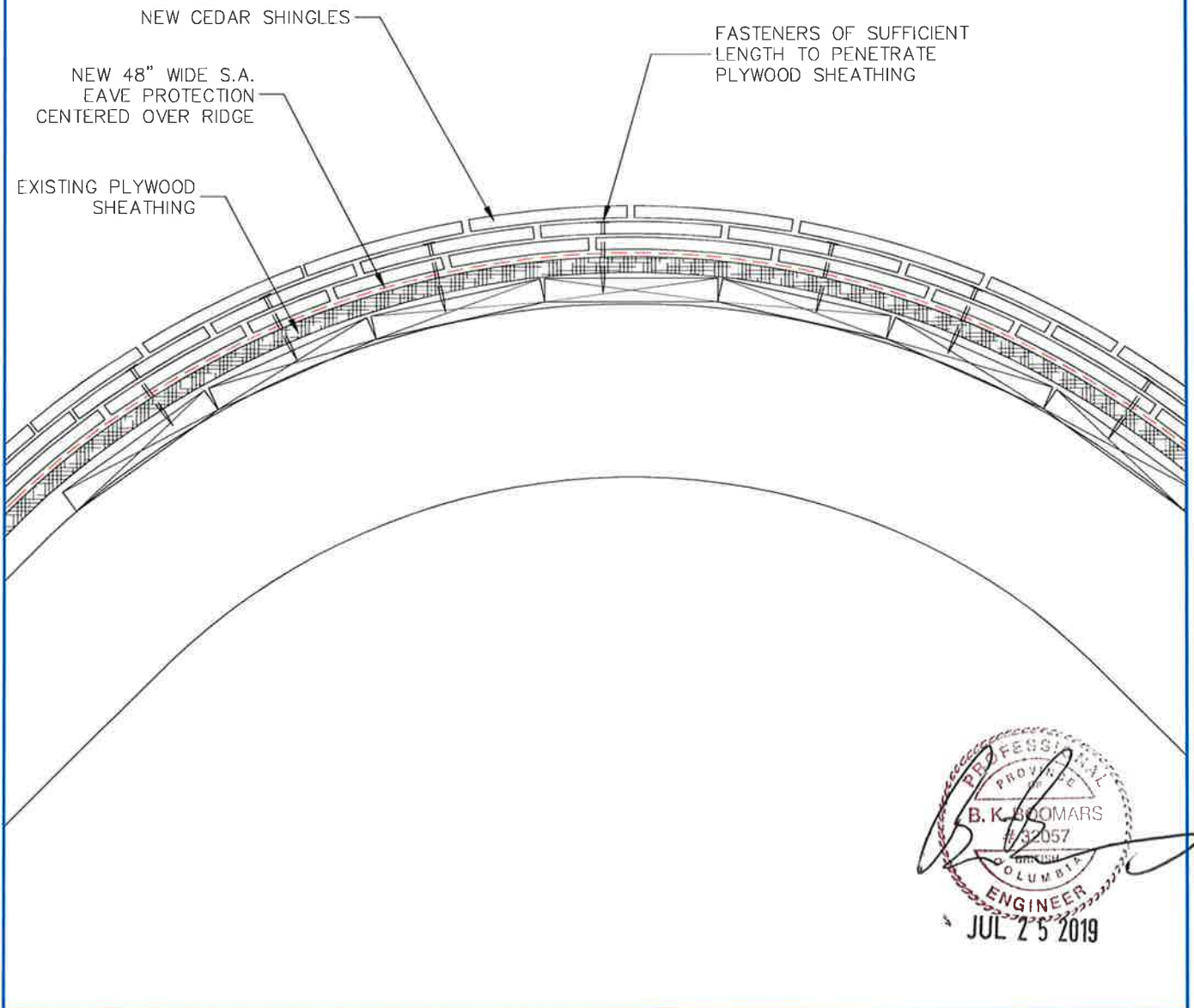

Project Title		Drawing title	
ROOF REPLACEMENT PACIFIC WILDLIFE RESEARCH CENTRE 5241 ROBERTSON ROAD, DETAIL, BC		CURVED HIP DETAIL	
Designed By	Approved By	Scale	
IRC GROUP	Date	1:5	
Drawn By	Tender	Date	
IRC GROUP	Project Manager	MAR 29/19	
Reviewed By	EC Project no.	Consultant Project No.	Drawing no.
Date		VR18-117SP-21476	D02
			Revision/ Revision
			0

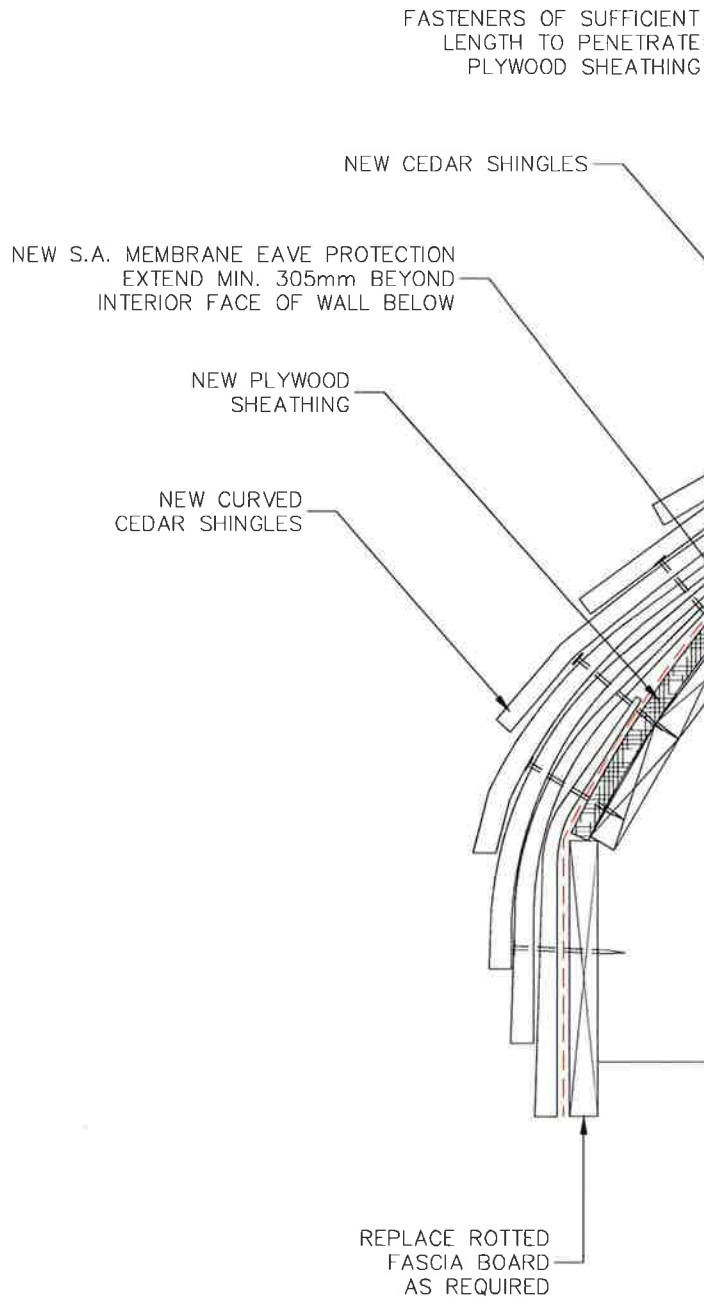

JUL 25 2019

Project Title ROOF REPLACEMENT PACIFIC WILDLIFE RESEARCH CENTRE 5241 ROBERTSON ROAD, DETAIL, BC		Drawing title CURVED EAVE DETAIL		
Designed By IRC GROUP	Approved By	Scale 1:5		
Drawn By IRC GROUP	Date	Tender	Date MAR 29/19	
Reviewed By	EC Project no.	Project Manager	Consultant Project No. VR18-117SP-21476	Drawing no. D03
Date				Revision/ Revision 0



Environment Canada
Environnement Canada



IRC Building Sciences Group
Le Groupe IRC

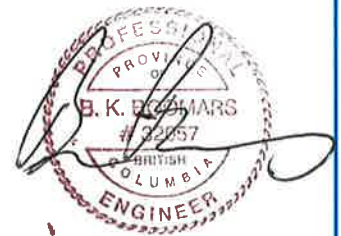
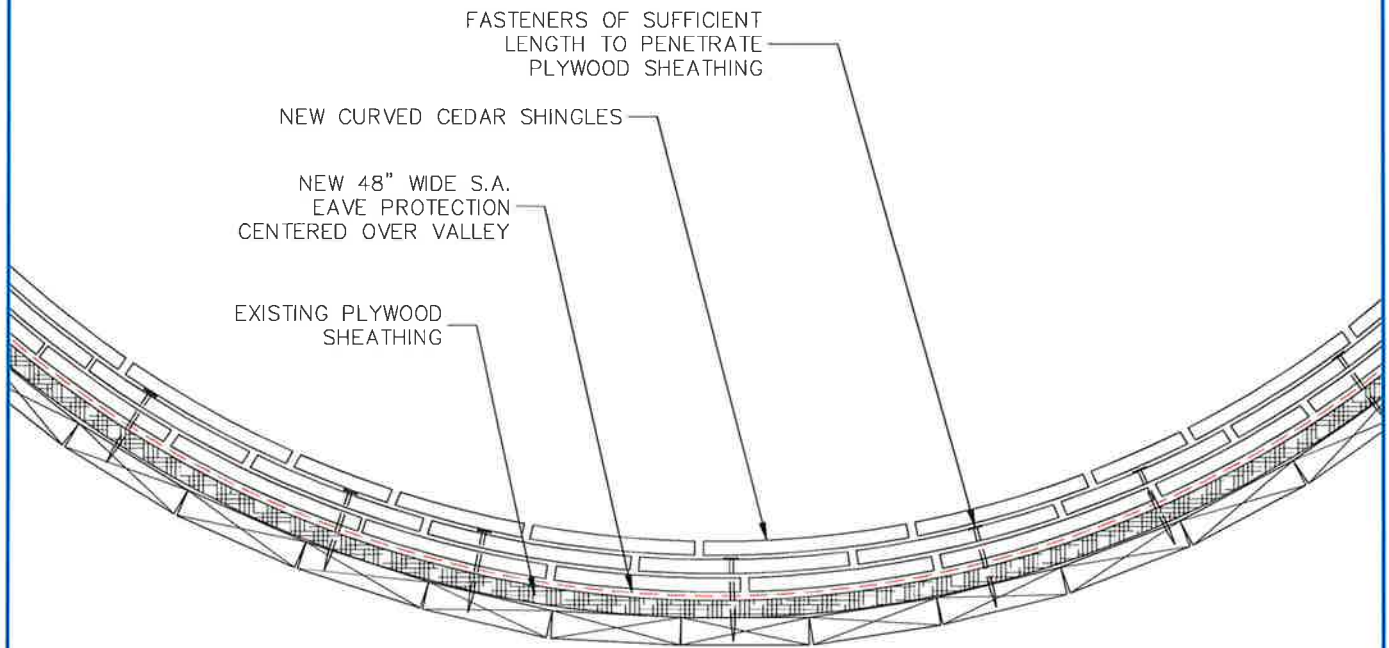

JUL 25 2019

Project Title		Drawing title		
ROOF REPLACEMENT PACIFIC WILDLIFE RESEARCH CENTRE 5241 ROBERTSON ROAD, DETAIL, BC		ROOF VALLEY DETAIL		
Designed By	IRC GROUP	Approved By	Scale	1:5
Drawn By	IRC GROUP	Date		
Reviewed By		Tender	Date	MAR 29/19
Date		Project Manager	Consultant Project No.	Drawing no.
		EC Project no.	VR18-117SP-21476	D04
				Revision/ Revision 0

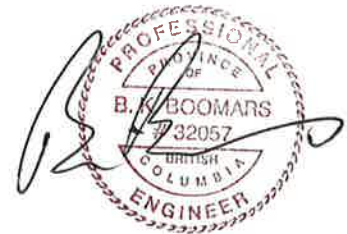
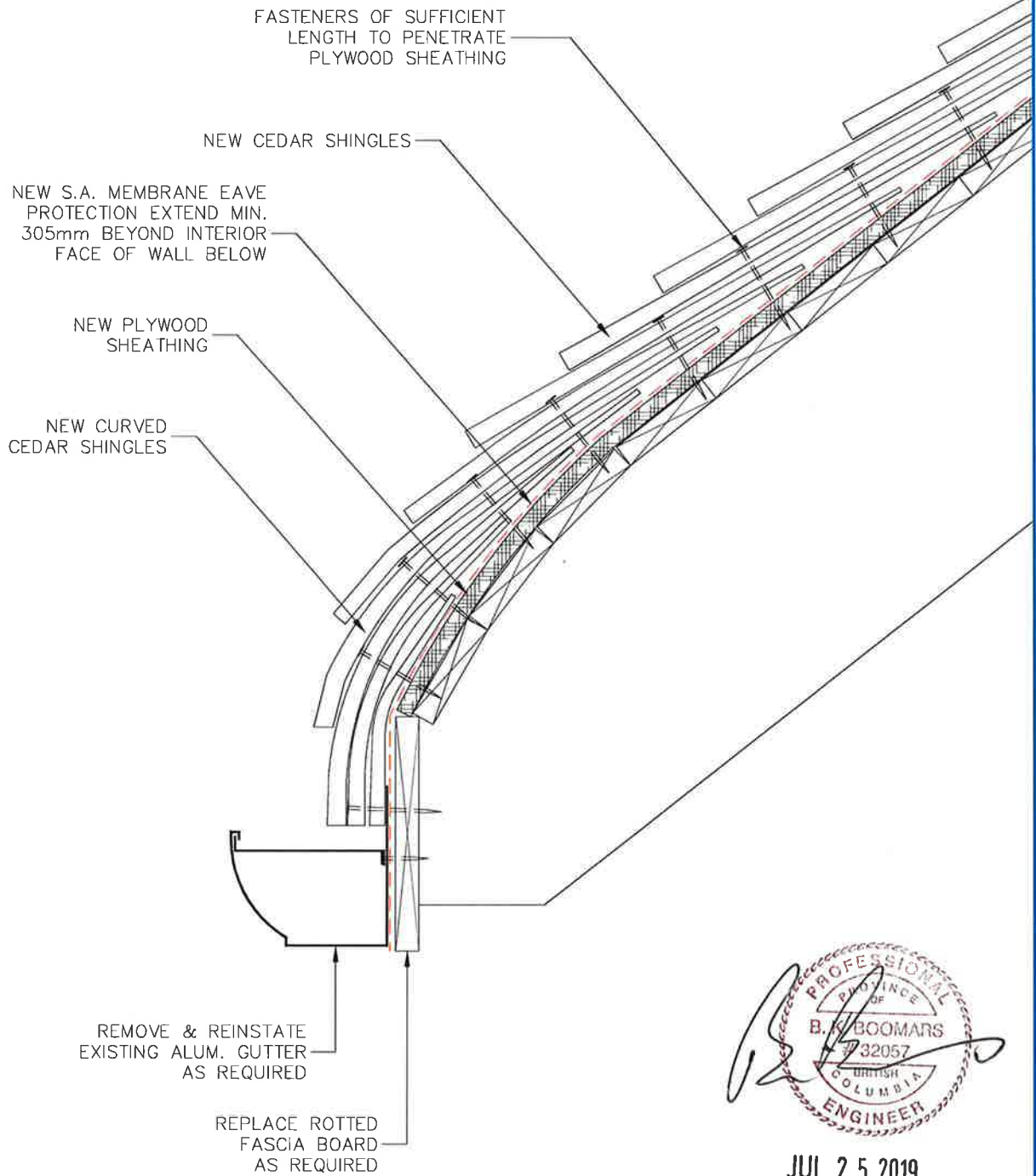

JUL 25 2019

Project Title		Drawing title	
ROOF REPLACEMENT PACIFIC WILDLIFE RESEARCH CENTRE 5241 ROBERTSON ROAD, DETAIL, BC		CURVED EAVE DETAIL WITH GUTTER	
Designed By	IRC GROUP	Approved By	Scale
		Date	1:5
Drawn By	IRC GROUP	Tender	Date
		Project Manager	MAR 29/19
Reviewed By		EC Project no.	Consultant Project No.
Date			VR18-117SP-21476
		Drawing no.	Revision/Revision
		D05	0



Environment Canada
Environnement Canada



IRC Building Sciences Group
Le Groupe IRC

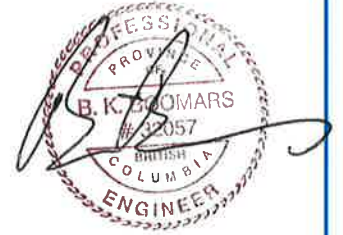

JUL 25 2019

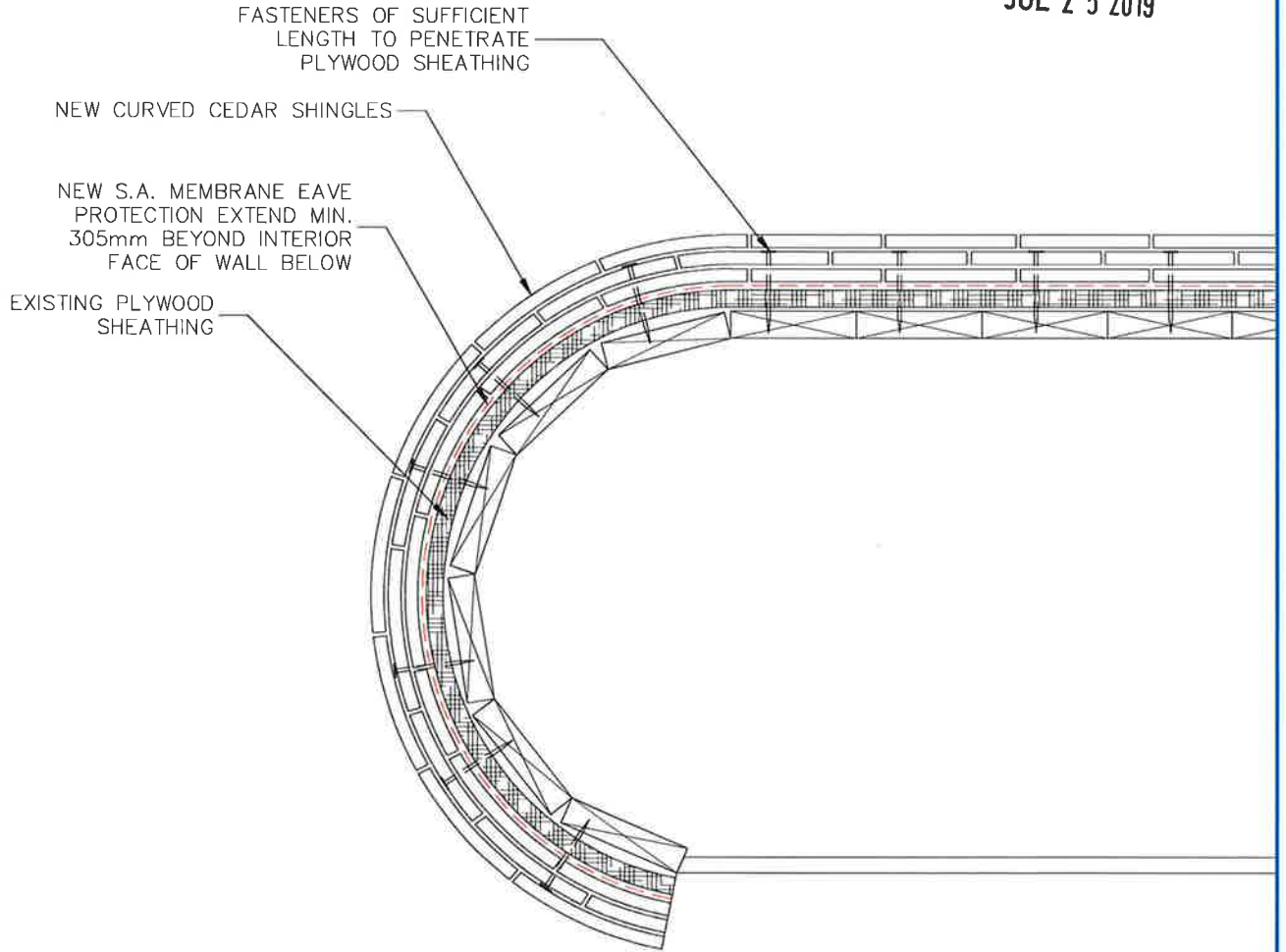

Project Title		Drawing title	
ROOF REPLACEMENT PACIFIC WILDLIFE RESEARCH CENTRE 5241 ROBERTSON ROAD, DETAIL, BC		CURVED RAKE DETAIL	
Designed By	Approved By	Scale	
IRC GROUP	Date	1:5	
Drawn By	Tender	Date	
IRC GROUP	Project Manager	MAR 29/19	
Reviewed By	EC Project no.	Consultant Project No.	Drawing no.
Date		VR18-117SP-21476	D06
			Revision/ Revision
			0



Environment Canada
Environnement Canada



IRC Building Sciences Group
Le Groupe IRC

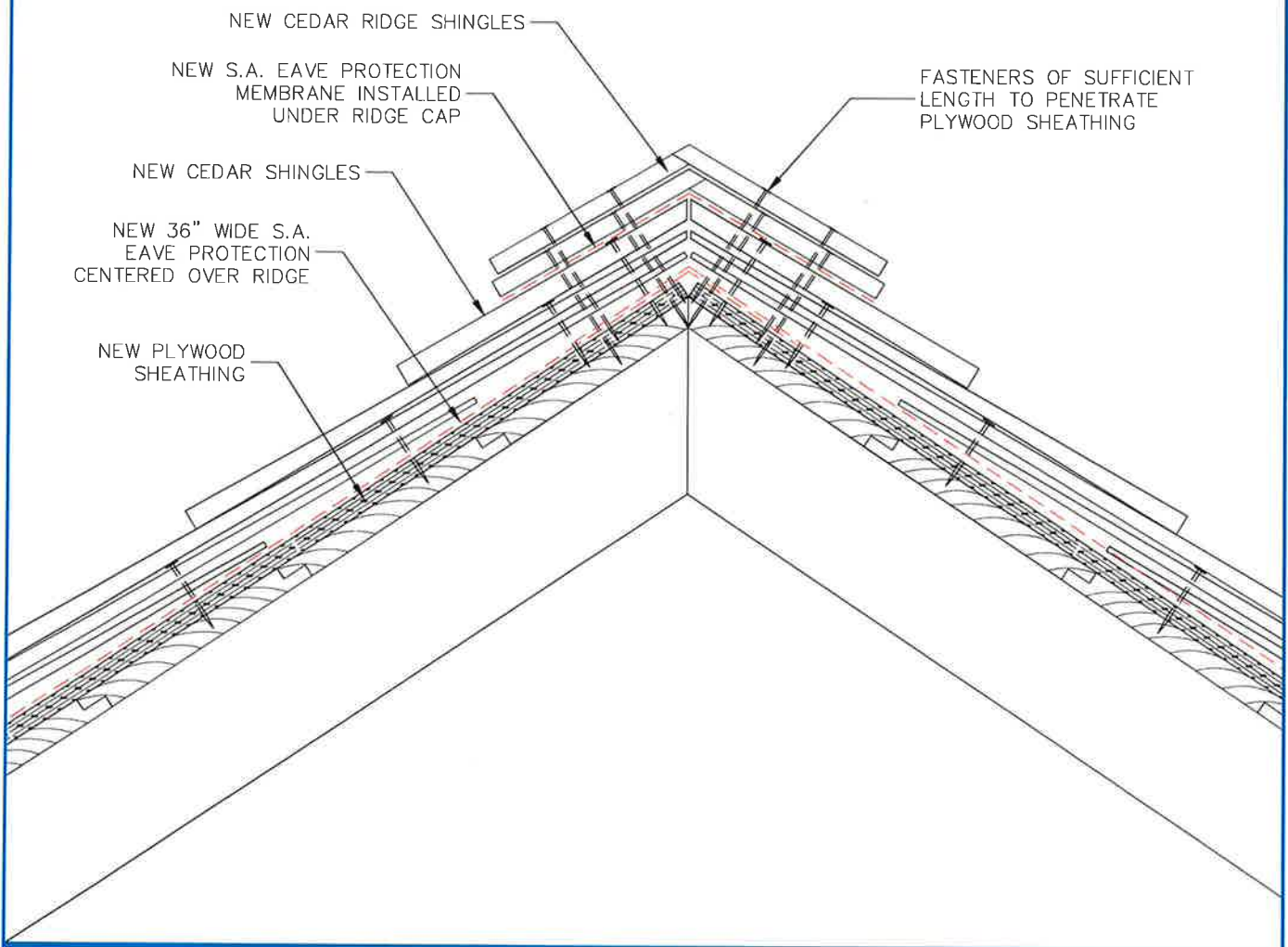
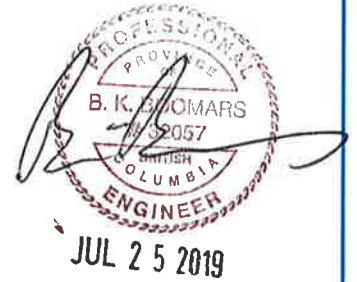

Project Title		Drawing title	
ROOF REPLACEMENT PACIFIC WILDLIFE RESEARCH CENTRE 5241 ROBERTSON ROAD, DETAIL, BC		RIDGE DETAIL	
Designed By	Approved By	Scale	
IRC GROUP		1:5	
Drawn By	Date	Tender	Date
IRC GROUP			MAR 29/19
Reviewed By	Project Manager	Consultant Project No.	Drawing no.
Date	EC Project no.	VR18-117SP-21476	D07
			Revision/ Revision 0



Environment Canada
Environnement Canada



IRC Building Sciences Group
Le Groupe IRC

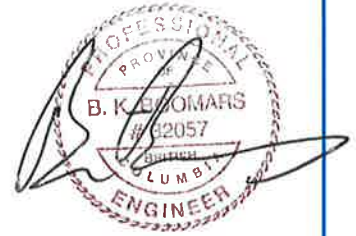

JUL 25 2019

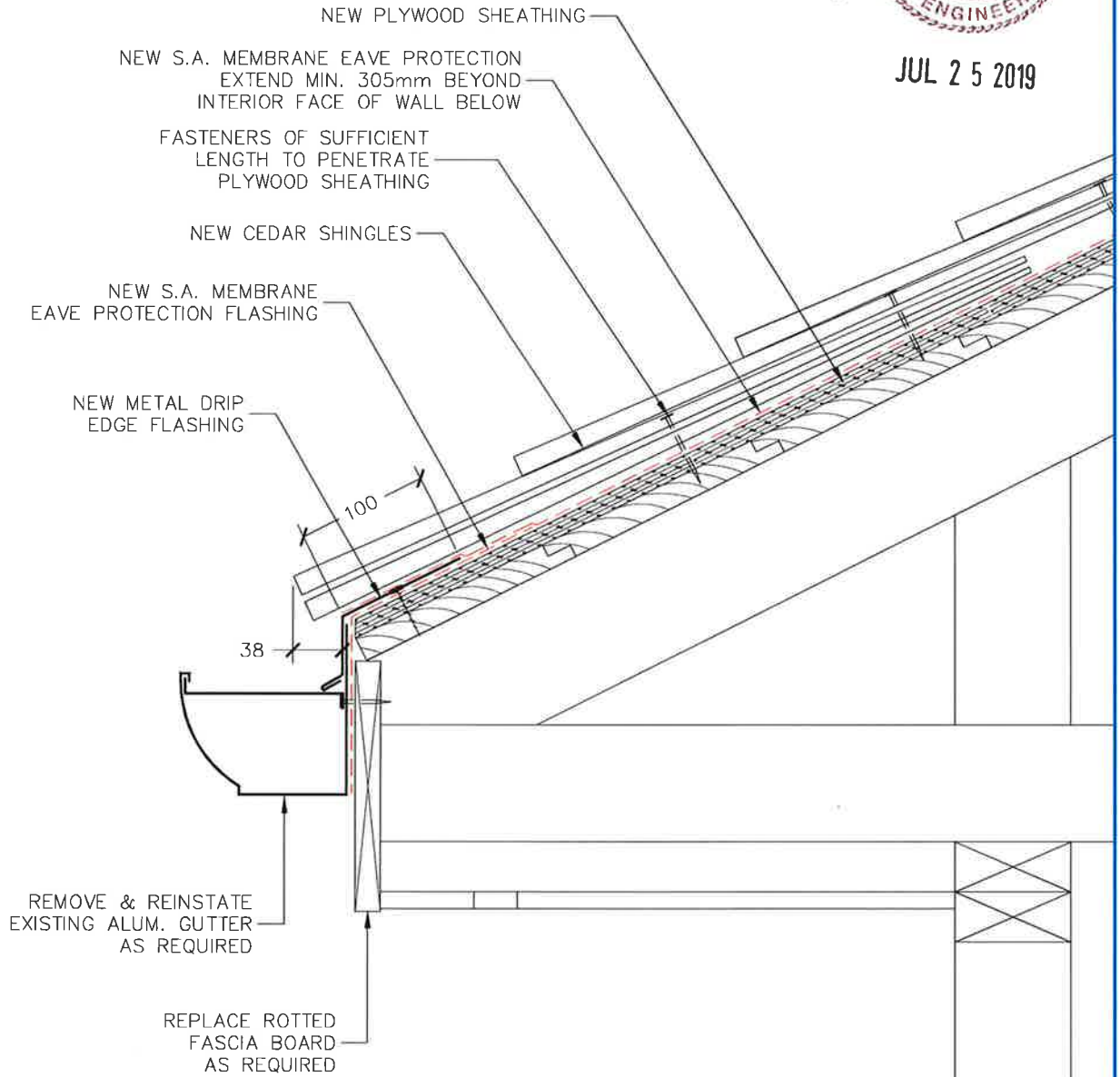

Project Title		Drawing title	
ROOF REPLACEMENT PACIFIC WILDLIFE RESEARCH CENTRE 5241 ROBERTSON ROAD, DETAIL, BC		EAVE WITH GUTTER DETAIL	
Designed By	Approved By	Scale	
IRC GROUP	Date	1:5	
Drawn By	Tender	Date	
IRC GROUP	Project Manager	MAR 29/19	
Reviewed By	EC Project no.	Consultant Project No.	Drawing no.
Date		VR18-117SP-21476	D08
			Revision/ Revision
			0



Environment Canada
Environnement Canada



IRC Building Sciences Group
Le Groupe IRC

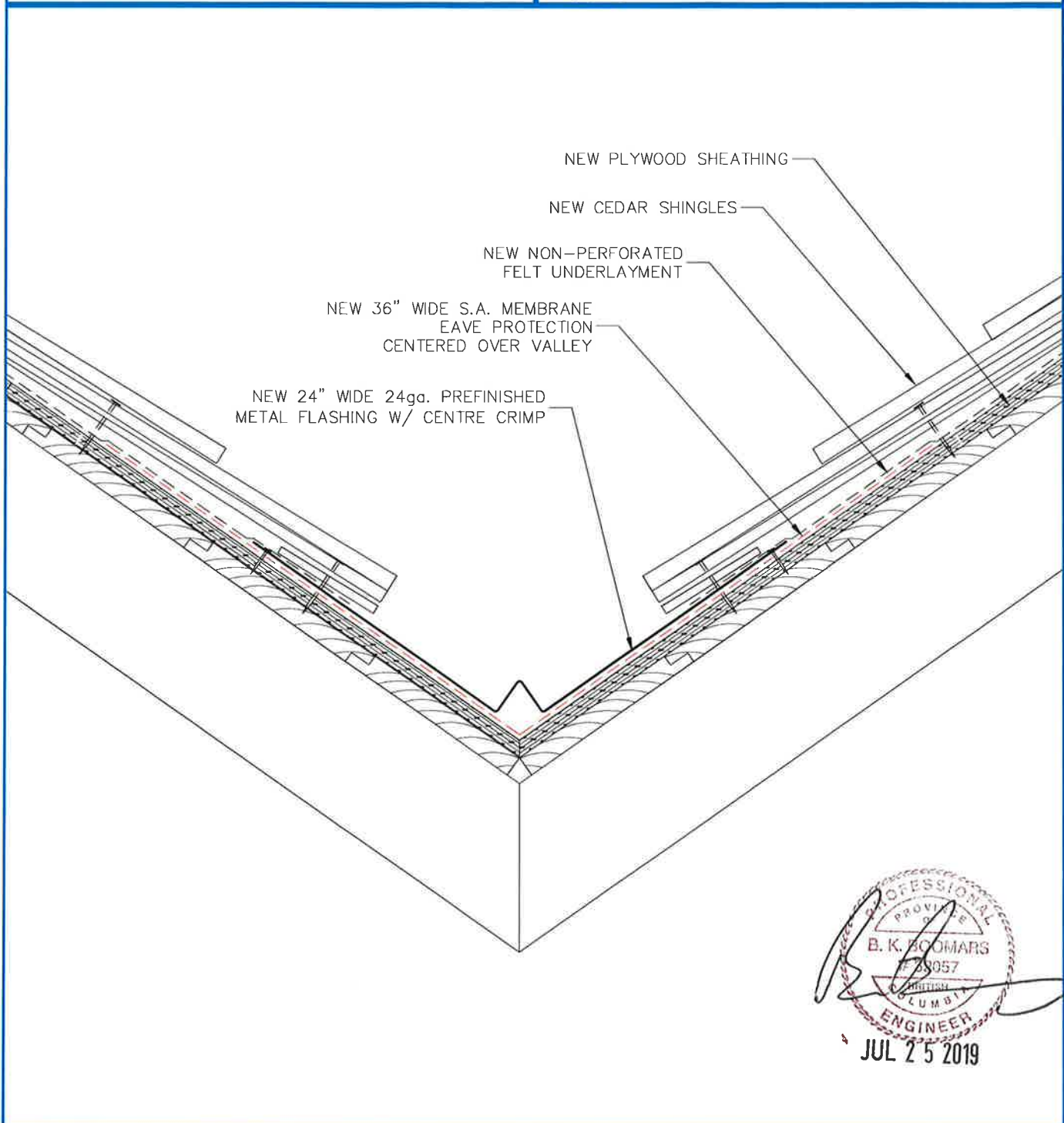

Project Title		Drawing title	
ROOF REPLACEMENT PACIFIC WILDLIFE RESEARCH CENTRE 5241 ROBERTSON ROAD, DETAIL, BC		VALLEY DETAIL	
Designed By	Approved By	Scale	
IRC GROUP	Date	1:5	
Drawn By	Tender	Date	
IRC GROUP	Project Manager	MAR 29/19	
Reviewed By	EC Project no.	Consultant Project No.	Drawing no.
Date		VR18-117SP-21476	D09
			Revision/ Revision
			0



Environment Canada
Environnement Canada



IRC Building Sciences Group
Le Groupe IRC

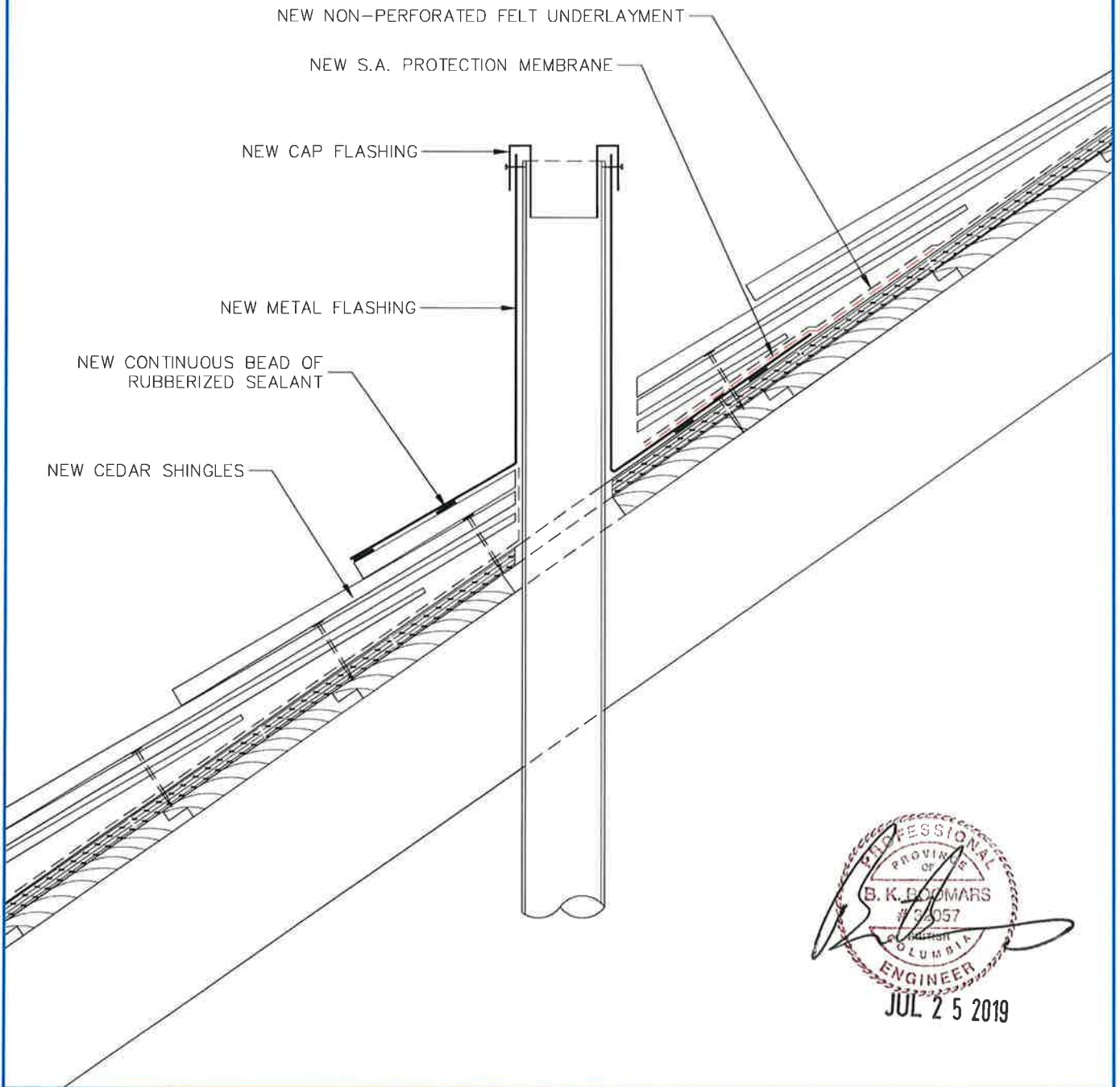

Project Title		Drawing title		
ROOF REPLACEMENT PACIFIC WILDLIFE RESEARCH CENTRE 5241 ROBERTSON ROAD, DETAIL, BC		PLUMBING STACK DETAIL		
Designed By	IRC GROUP	Approved By	Scale	
Drawn By	IRC GROUP	Date	1:5	
Reviewed By		Tender	Date	MAR 29/19
Date		Project Manager	Consultant Project No.	Drawing no.
		EC Project no.	VR18-117SP-21476	D10
				Revision/ Revision 0

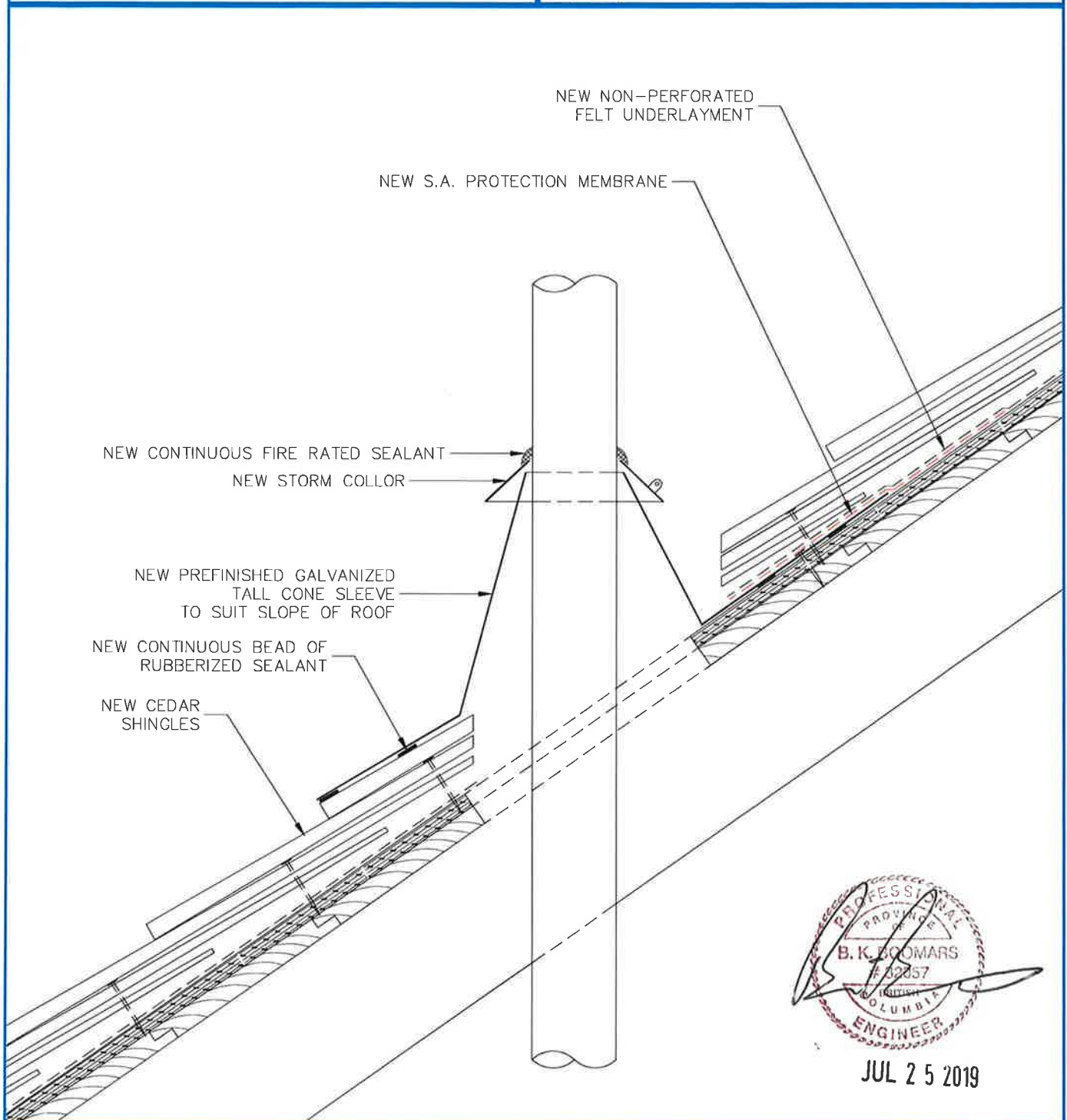

PROFESSIONAL
PROVINCE OF
B. K. BOOMARS
22857
COLUMBIA
ENGINEER
JUL 25 2019

Project Title		Drawing title	
ROOF REPLACEMENT PACIFIC WILDLIFE RESEARCH CENTRE 5241 ROBERTSON ROAD, DETAIL, BC		B-VENT DETAIL	
Designed By	Approved By	Scale	
IRC GROUP	Date	1:5	
Drawn By	Tender	Date	
IRC GROUP	Project Manager	MAR 29/19	
Reviewed By	EC Project no.	Consultant Project No.	Drawing no.
Date		VR18-117SP-21476	D11
			Revision/ Revision 0



Environment Canada
Environnement Canada



IRC Building Sciences Group
Le Groupe IRC

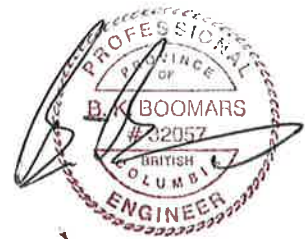
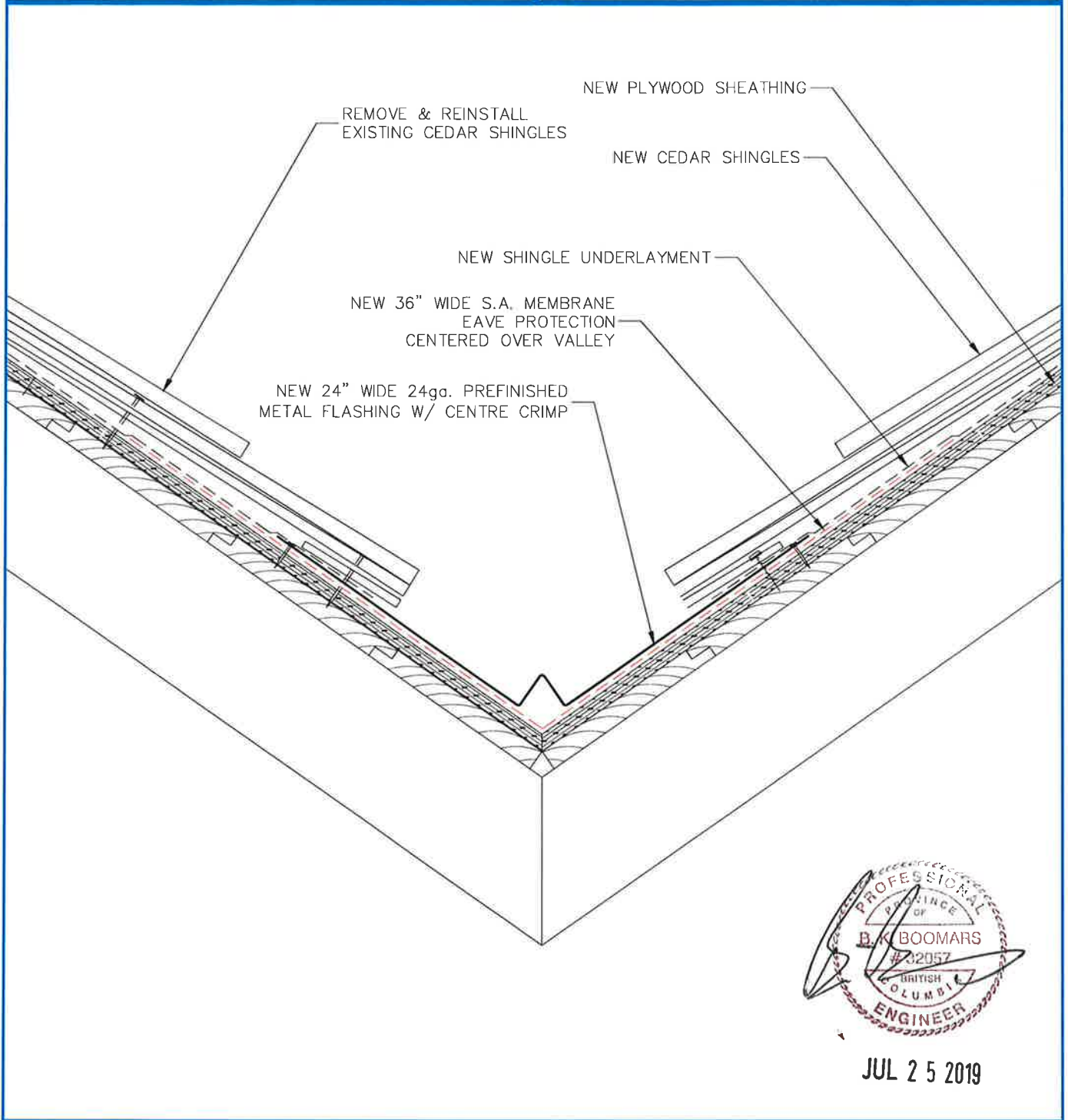

JUL 25 2019

Project Title		Drawing title	
ROOF REPLACEMENT PACIFIC WILDLIFE RESEARCH CENTRE 5241 ROBERTSON ROAD, DETAIL, BC		VALLEY DETAIL	
Designed By	Approved By	Scale	
IRC GROUP		1:5	
Drawn By	Date	Date	
IRC GROUP		MAR 29/19	
Reviewed By	Project Manager	Consultant Project No.	Drawing no.
Date	EC Project no.	VR18-117SP-21476	D21
			Revision/ Revision 0



Environment Canada
Environnement Canada



IRC Building Sciences Group
Le Groupe IRC

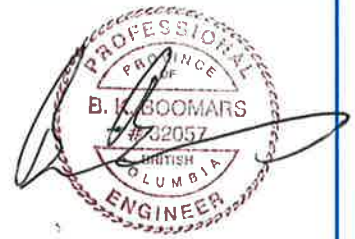

JUL 25 2019

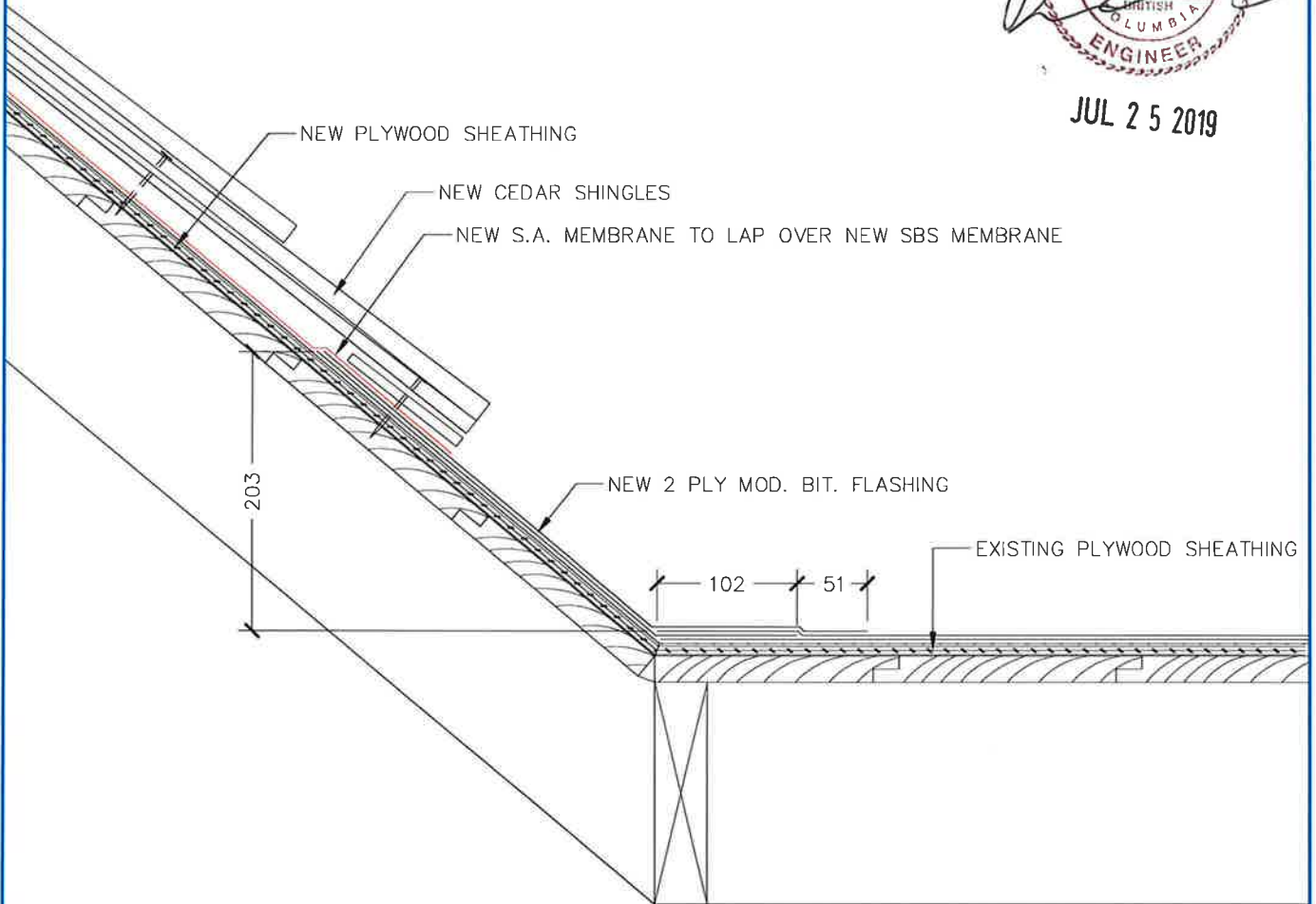

Project Title		Drawing title		
ROOF REPLACEMENT PACIFIC WILDLIFE RESEARCH CENTRE 5241 ROBERTSON ROAD, DETAIL, BC		TRANSITION DETAIL		
Designed By	IRC GROUP	Approved By	Scale	
		Date	1:5	
Drawn By	IRC GROUP	Tender	Date	MAR 29/19
Reviewed By		Project Manager	Consultant Project No.	Drawing no.
Date		EC Project no.	VR18-117SP-21476	D23
				Revision/ Revision 0



Environment Canada
Environnement Canada



IRC Building Sciences Group
Le Groupe IRC



NEW 2 PLY MOD. BIT. MEMBRANE
EXISTING PLYWOOD SHEATHING
EXISTING SHIPLAP WOOD DECK

EXISTING WINDOW

NEW MOD. BIT. BASE & CAP FLASHING

NEW REINFORCED ALSAN FLASHING

NEW PLYWOOD SHEATHING

102 51

Project Title		Drawing title		
ROOF REPLACEMENT PACIFIC WILDLIFE RESEARCH CENTRE 5241 ROBERTSON ROAD, DETAIL, BC		WINDOW SILL DETAIL		
Designed By	IRC GROUP	Approved By	Scale	1:5
Drawn By	IRC GROUP	Date		
Reviewed By		Tender	Date	MAR 29/19
Date		Project Manager	Consultant Project No.	Drawing no.
		EC Project no.	VR18-117SP-21476	D24
				Revision/ Revision 0



Environment Canada
Environnement Canada



IRC Building Sciences Group
Le Groupe IRC

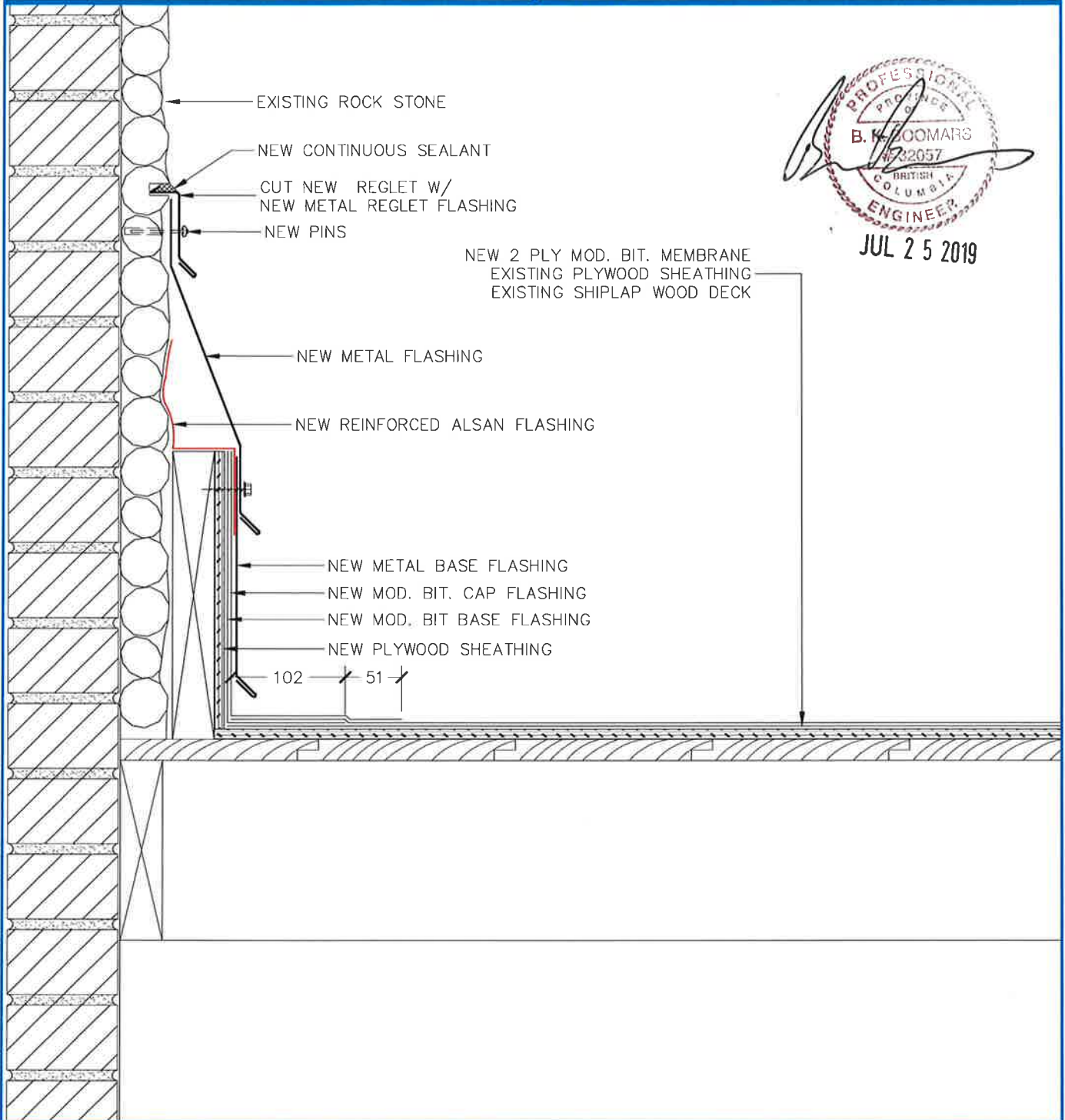

JUL 2 5 2019

Project Title		Drawing title	
ROOF REPLACEMENT PACIFIC WILDLIFE RESEARCH CENTRE 5241 ROBERTSON ROAD, DETAIL, BC		CHIMNEY DETAIL	
Designed By	Approved By	Scale	
IRC GROUP	Date	1:5	
Drawn By	Tender	Date	
IRC GROUP	Project Manager	MAR 29/19	
Reviewed By	EC Project no.	Consultant Project No.	Drawing no.
Date		VR18-117SP-21476	D25
			Revision/ Revision 0



Environment Canada
Environnement Canada



IRC Building Sciences Group
Le Groupe IRC



NEW 2 PLY MOD. BIT. MEMBRANE
EXISTING PLYWOOD SHEATHING
EXISTING SHIPLAP WOOD DECK

NEW STRAINER BOLT
NEW ALUMINUM STRINER
NEW MENZIE CLAMP-TITE
COPPER DRAIN

SET PRIMED FLANGE
IN LAYER OF SEALANT

NEW MOD. BIT. BASE FLASHING

100

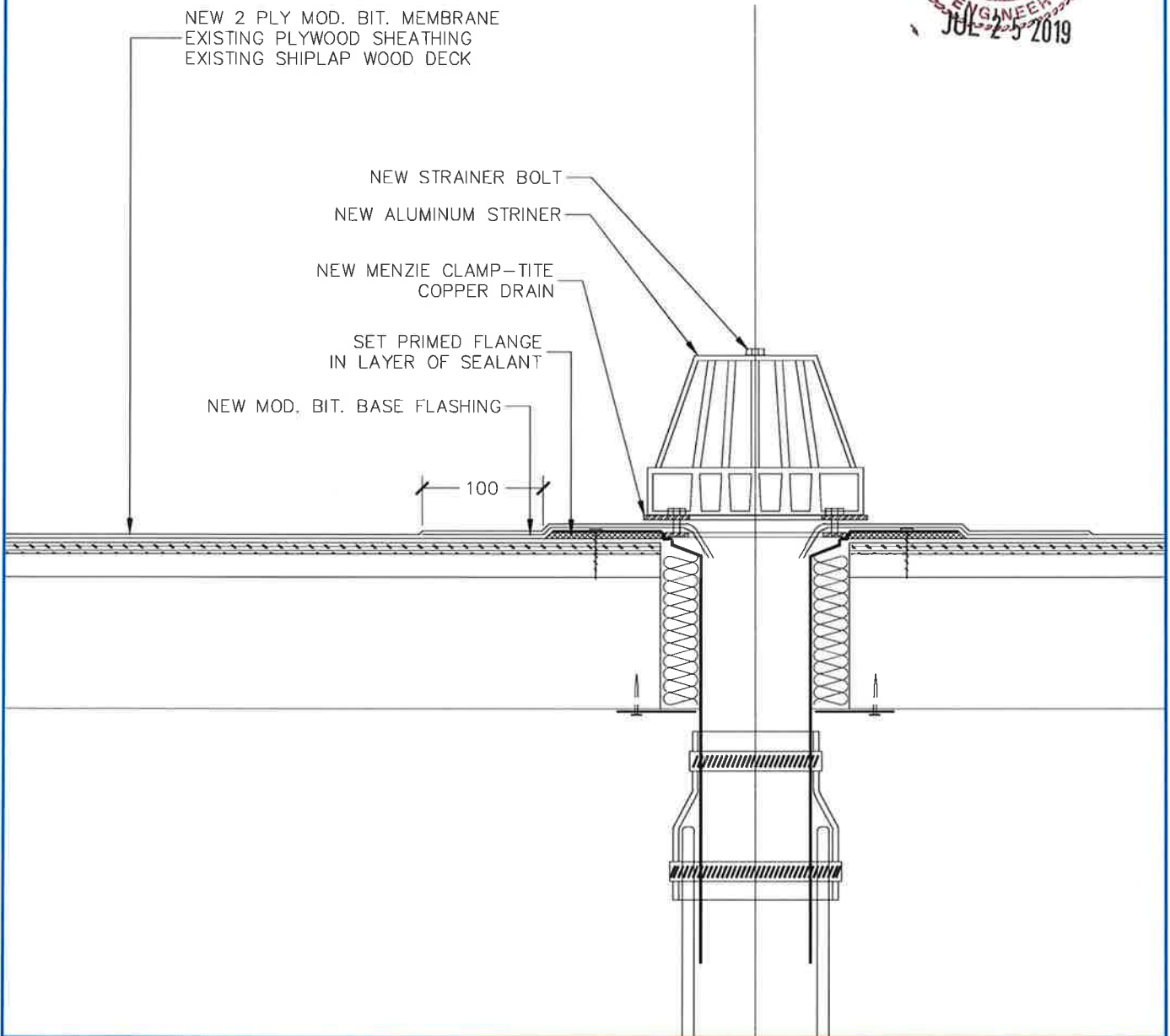

Project Title
**ROOF REPLACEMENT
PACIFIC WILDLIFE RESEARCH CENTRE
5241 ROBERTSON ROAD, DETAIL, BC**

Drawing title
DRAIN DETAIL

Designed By
IRC GROUP

Approved By
Date

Scale
1:5

Drawn By
IRC GROUP

Tender
Project Manager

Date
MAR 29/19

Reviewed By
Date

EC Project no.,

Consultant Project No.
VR18-117SP-21476

Drawing no.
D28

Revision/
Revision
0



Environment Canada
Environnement Canada



IRC Building Sciences Group
Le Groupe IRC

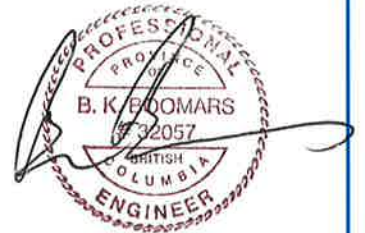

JUL 25 2019

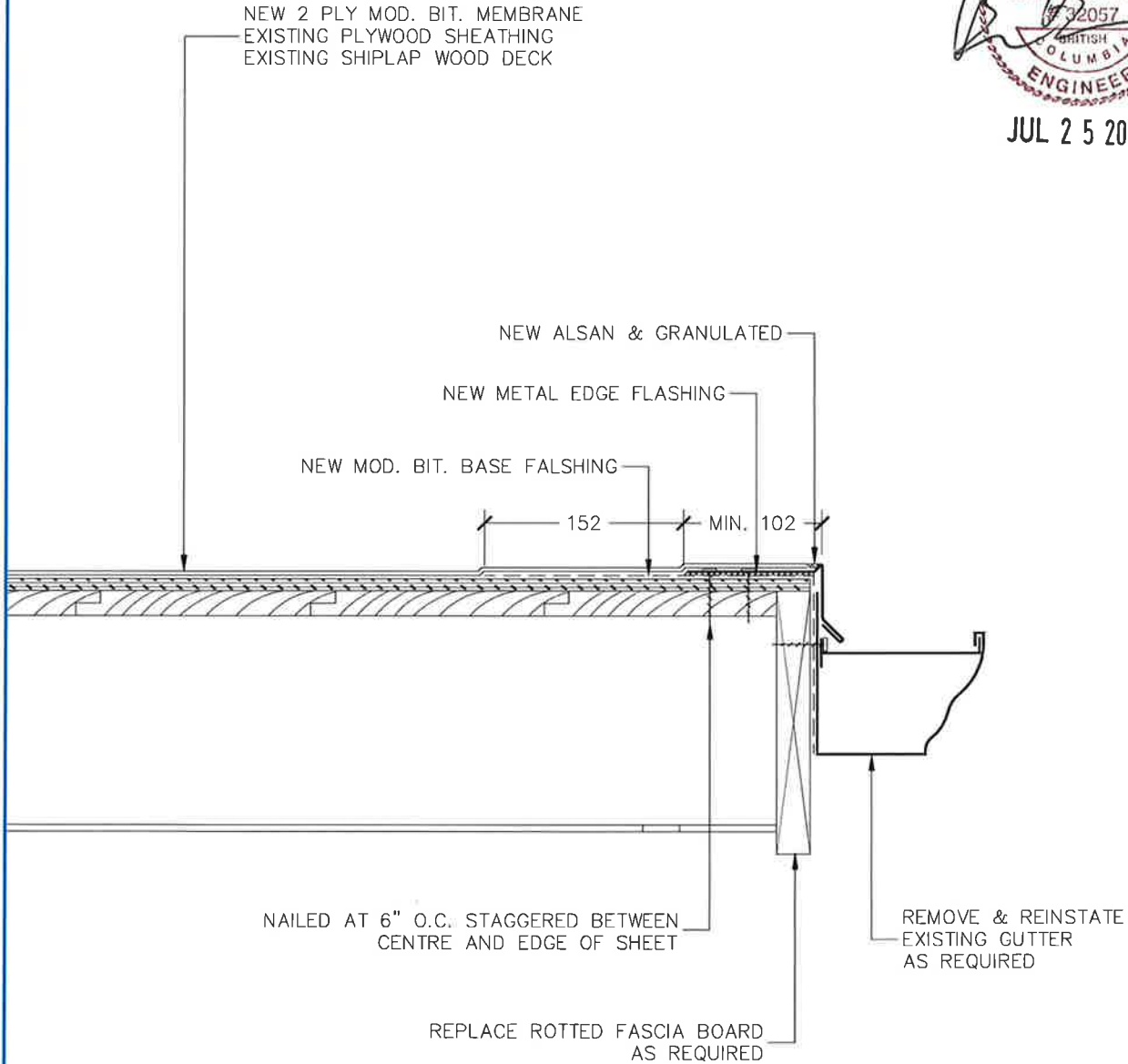

Project Title
**ROOF REPLACEMENT
PACIFIC WILDLIFE RESEARCH CENTRE
5241 ROBERTSON ROAD, DETAIL, BC**

Drawing title
ROOF EDGE WITH GUTTER DETAIL

Designed By
IRC GROUP

Approved By
Date

Scale
1:5

Drawn By
IRC GROUP

Tender
Project Manager

Date
MAR 29/19

Reviewed By
Date

EC Project no.

Consultant Project No.
VR18-117SP-21476

Drawing no.
D29

Revision/
Revision
0

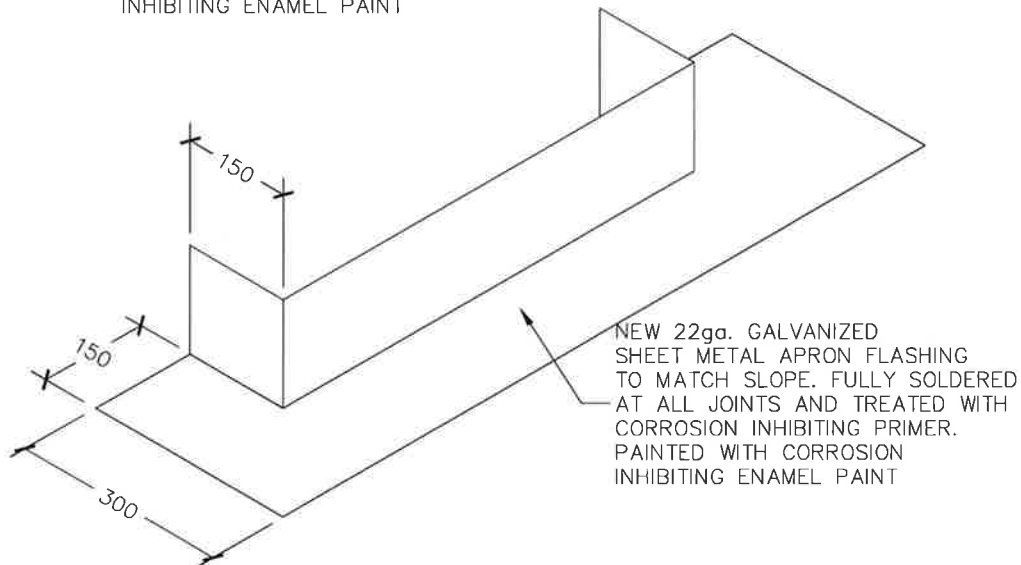
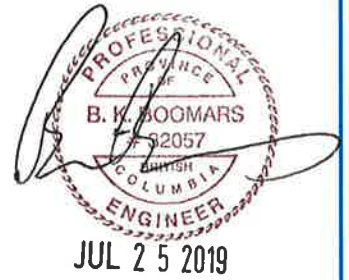
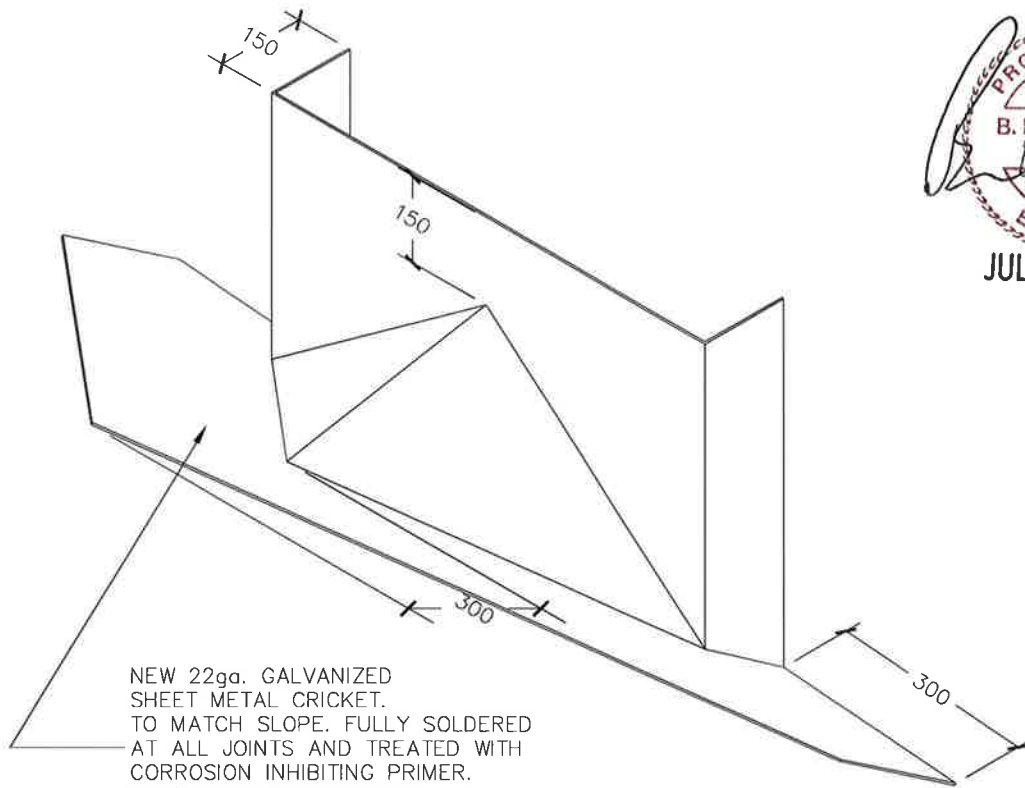

Project Title		Drawing title	
ROOF REPLACEMENT PACIFIC WILDLIFE RESEARCH CENTRE 5241 ROBERTSON ROAD, DETAIL, BC		TYPICAL CHIMNEY CRICKET & APRON DETAIL	
Designed By	Approved By	Scale	
IRC GROUP		1:5	
Drawn By	Date	Date	
IRC GROUP		MAR 29/19	
Reviewed By	Project Manager	Consultant Project No.	Revision/
Date	EC Project no.	VR18-117SP-21476	D31 0