

Office Furniture Work Package 2nd floor

Office Furniture Work Package
2nd floor

List of products from each 1A & 1B

Name	QNT.	Size	Desribthion	Panel Matrix	Location
Panels non powered CAT1a	2	54Hx24"W	24"W Base Height acoustic Panels + tackable fabric add-on with frame	panel matrix B	215
	1	54Hx48"W	48"W Base Height acoustic Panels+ tackable fabric add-on with frame	panel matrix B	215
	2	54Hx60"W	60"W Base Height Panels+ tackable fabric add-on with frame	panel matrix B	215
CAT 1b Personal Storage locker	3 Left	51.2"Hx24"Wx24"D	File, File, Metal, Left Ward.,keyed, Rect Pull Line #65 - - CAT 1B GOCUID #1BSPSCLGA242454XKXX		276
	6 Right	51.2"Hx24"Wx24"D	File, File, Metal, Right Ward., Rect Pull, keyed		215 and 276

List of products Cat 5(E)

Item No.	QTY.	Cat 5 (E)	material
1	9	Power Module, Power/USB, Desk Edge Clamp Line #20 - - CAT 5 GOCUID #5PMOWKSMTACUSBXXXX Case Finish: 83 - Very White	
2	9	Monitor arm, for dual monitors, edge clamp mount.	

List of products Cat 2-HA tables

Item No.	QTY.	Cat 2 -HA tables	size	material	location
1	3	individual, height adjustable work surface, electrically assisted; seat/stand range 23"-48.7" ,	30"Wx54"L	laminite worksurface	276
2	1	<u>Modular height adjustable benching:</u> 3 work surface long; each HA worksurface should be electric; benching should have 2 dual receptacles per each HA worksurface- total QNT.12 ; benching should have 1 DVO per each HA worksurface- 6 DVO total <u>Screen requirements:</u> 1. fixed to the center of the bench; 2. 42"high	30"Wx54"L	laminite worksurface fabric screen	217,216,215

List of products miscellaneous

Other	QTY.	Location	Size	Requirements
Task Chairs	9	7OCHNBMLAASSALMTCUBF		
Horizontal Cable management system	9		24"Lx3.6"Diameter	Should be installed underneath all Height Adjustable tables
Base feed for power	1	217,216,215		
Base feed for data	1	217,216,215		

Panel matrix-B █
24" , 48" , 60" Panels
Base Height + tackable fabric Add-On with frame,
Non-Powered

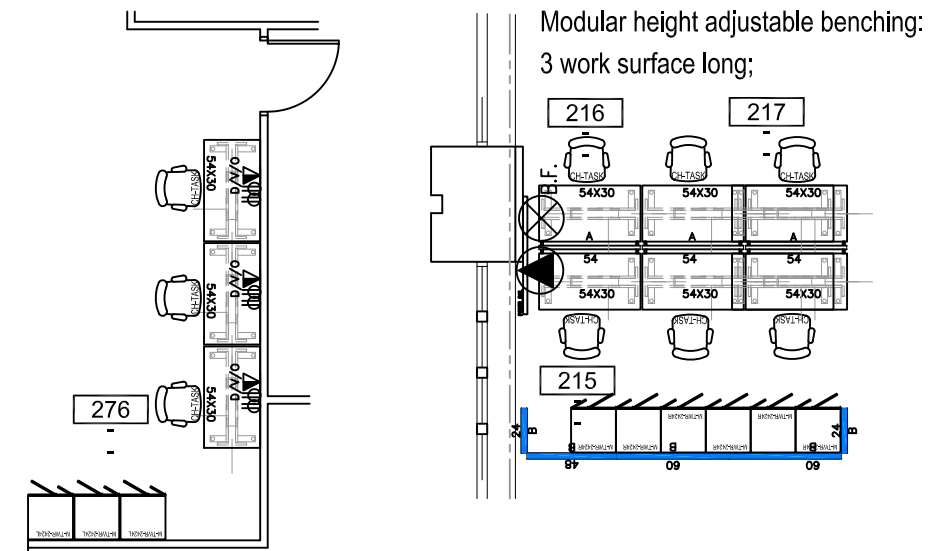
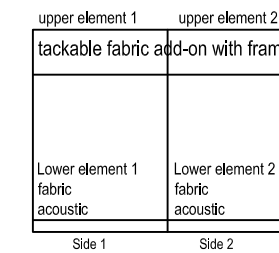

Office Furniture Work Package 3rd floor

List of products Cat 1B

Name	QNT.	Size	Desribthion	Location
CAT 1b Personal Storage locker	1 Left	51.2"Hx24"Wx24"D	File, File, Metal, Left Ward., Rect Pull, keyed	378
	1 Right	51.2"Hx24"Wx24"D	File, File, Metal, Right Ward., Rect Pull, keyed	378

List of products Cat 5(E)

Item No.	QTY.	Cat 5 (E)	material
1	2	Power Module, Power/USB, Desk Edge Clamp Line #20 - - CAT 5 GOCUID #5PMOWKSMTACUSBXXXXX Case Finish: 83 - Very White	
2	2	monitor arm, for dual monitors, edge clamp mount	

List of products Cat 2-HA tables

Item No.	QTY.	Cat 2 (Freestanding Height Adjustable Desk/Table Products)	material
1	2	seat/stand range height adjustable work surface 30"Wx 54"L electrically assisted, seat/stand range 23"-48.7" ,	laminata

List of products miscellaneous

Other	QTY.	Size	Requirements
Task Chairs	2	70CHNBMLAASSAL	MTCUBF
Horizontal Cable management system	2	24"Lx3.6"Diameter	Should be installed underneath all Height Adjustable tables

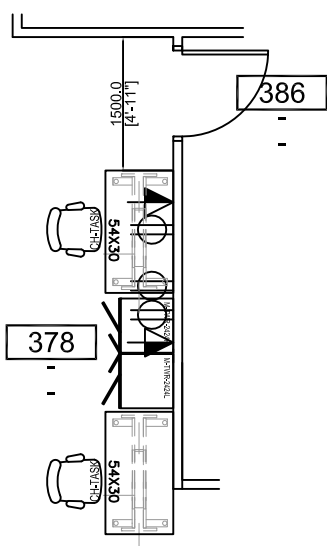

Office Furniture Work Package 5th floor

List of products from each 1A & 1B tackable fabric add-on with frame

Name	QNT.	Size	Desribthion	Panel Matrix	Location
Panels powered CAT1a	2	54"Hx24"W	24"w Base Height acoustic Panels + tackable fabric add-on with frame	panel matrix C	507
	1	54"Hx54"W	54"w Base Height acoustic Panels + tackable fabric add-on with frame	panel matrix C	507
Panels non powered CAT1a	3	54Hx24"W	24"w Base Height acoustic Panels + tackable add on, fabric	panel matrix B	507
	2	54Hx36"W	36"w Base Height acoustic Panels + tackable add on, fabric	panel matrix B	528
CAT 1b Personal Storage locker	6 Left	51.2"Hx24"Wx24"D	File, File, Metal, Left Ward., Rect Pull, keyed		
	1 Right	51.2"Hx24"Wx24"D	File, File, Metal, Right Ward., Rect Pull, keyed		

List of products Cat 5(E)

Item No.	QTY.	Cat 5 (E)	material
1	7	Power Module, Power/USB, Desk Edge Clamp Line #20 - - CAT 5 GOCUID #5PMOWKSMTACUSBXXXXX Case Finish: 83 - Very White	
2	7	monitor arm, for dual monitors, edge clamp mount	

List of products Cat 2-HA tables

Item No.	QTY.	Cat 2 (Freestanding Height Adjustable Desk/Table Products)	size	material	location
1	3	individual, seat/stand range height adjustable work surface electrically assisted, seat/stand range 23"-48.7"	30"W x 54"L	laminate	507
2	1	<u>Modular height adjustable benching:</u> 2 work surface long, 30"Wx54"L each desk; each HA worksurface should be electric; benching should have 2 dual receptacles per each HA worksurface- total QNT.8 ; benching should have 1 DVO per each HA worksurface- 4 DVO total; <u>Screen requirements:</u> 1. fixed to the center of the bench; 2. 42"high		laminate worksurface fabric screen	528

List of products miscellaneous

Other	QTY.	Location	Size	Requirements
Task Chairs	7	70CHNBMLAASSALMTTCUBF		
Horizontal Cable management system	7		24"Lx3.6"Diameter	Should be installed underneath all Height Adjustable tables
Base feed for power	2	528, 507		
Base feed for data	2	528, 507		

Office Furniture Work Package 5th floor

Panel matrix-C

24" Panels

Base Height + tackable fabric Add-On with frame, Powered outlet(s) and DATA below work surface (Double sided) access for the data and power base feeds

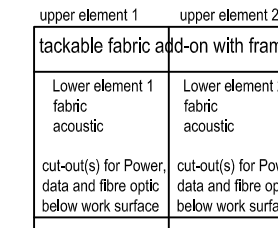

Side 1 Side 2

Panel matrix-B

24" and 36" Panels

Base Height + tackable fabric Add-On with frame, Non-Powered

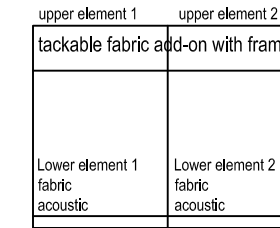

Side 1 Side 2

PANEL FOR VISUAL BARRIER AT SEATING POSITION

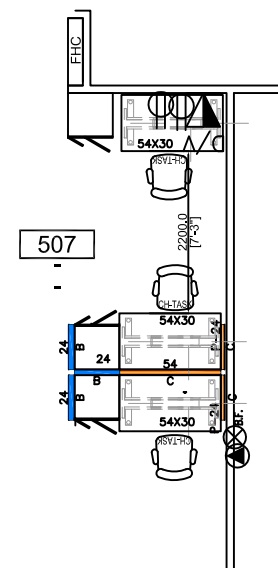
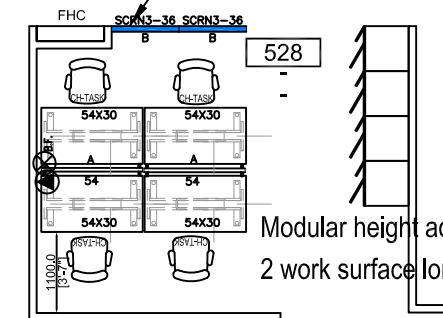

Office Furniture Work Package 6th floor

List of products Cat 1B

Name	QNT.	Size	Desribthion	Location
CAT 1b Personal Storage locker	2 Left	51.2"Hx24"Wx24"D	File, File, Metal, Left Ward., Rect Pull, keyed	378
	2 Right	51.2"Hx24"Wx24"D	File, File, Metal, Right Ward., Rect Pull, keyed	378

List of products Cat 5(E)

Item No.	QTY.	Cat 5 (E)	material
1	4	Power Module, Power/USB, Desk Edge Clamp Line #20 - - CAT 5 GOCUID #5PMOWKSMTACUSBXXXXX Case Finish: 83 - Very White	
2	4	monitor arm, for dual monitors, edge clamp mount	

List of products Cat 2-HA tables

Item No.	QTY.	Cat 2 (Freestanding Height Adjustable Desk/Table Products)	material
1	4	seat/stand range height adjustable work surface 30"W x 54"L electrically assisted, seat/stand range 23"-48.7" ,	laminata

List of products miscellaneous

Other	QTY.	Size	Requirements
Task Chairs	4	70CHNBMLAASSALMTCUBF	
Horizontal Cable management system	4	24"Lx3.6"Diameter	Should be installed underneath all Height Adjustable tables

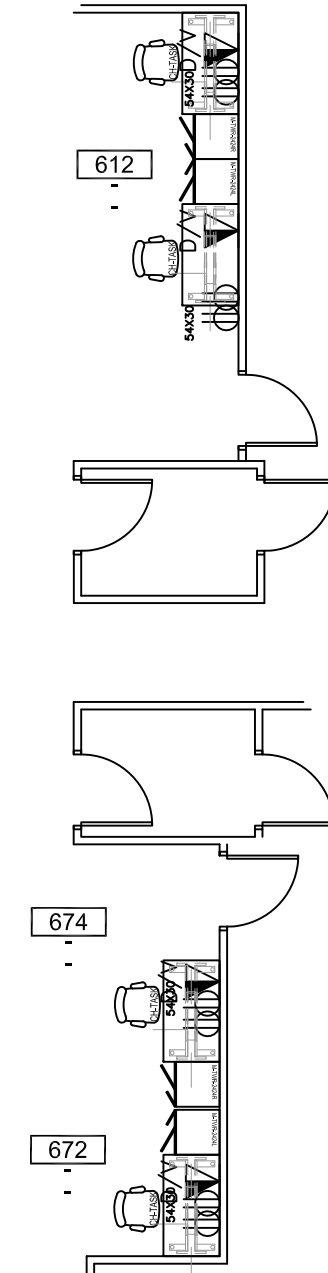

Office Furniture Work Package
7th floor

List of products from each 1A & 1B

Name	QNT.	Size	Material	Panel Matrix	Location
Panels powered CAT1a	2	54"Hx 48"W	54"W Base Height acoustic Panels + tackable fabric add-on with frame	panel matrix C	711A
	1	34"Hx30"W	Base Height acoustic	panel matrix E	711A
Panels non powered CAT1a	2	54Hx30"W	30"W Base Height acoustic Panels + tackable fabric add-on with frame	panel matrix B	711A
	1	54Hx24"W	24"W Base Height acoustic Panels + tackable fabric add-on with frame	panel matrix B	711A
CAT 1b Personal Storage locker	3 Left	51.2"Hx24"Wx24"D	File, File, Metal, Left Ward., Rect Pull, keyed		
	1 Right	51.2"Hx24"Wx24"D	File, File, Metal, Right Ward., Rect Pull, keyed		

List of products Cat 5(E)

Item No.	QTY.	Cat 5 (E)	material
1	4	Power Module, Power/USB, Desk Edge Clamp Line #20 - - CAT 5 GOCUID #5PMOWKSMTACUSBXXXXX Case Finish: 83 - Very White	
2	4	monitor arm, for dual monitors, edge clamp mount	

List of products Cat 2-HA tables

Item No.	QTY.	Cat 2 (Freestanding Height Adjustable Desk/Table Products)	Size	material	location
1	2	seat/stand range height adjustable work surface 30"W x 54"L electrically assisted, seat/stand range 23"-48.7" ,	30'Wx54"L	laminate	770
2	2	seat/stand range height adjustable work surface electrically assisted, seat/stand range 23"-48.7"	30'Wx48"L	laminate	711A

List of products miscellaneous

Other	QTY.	Size	Requirements
Task Chairs	4	70CHNBMLAASSALMTCUBF	
Horizontal Cable management system	4	24"Lx3.6"Diameter	Should be installed underneath all Height Adjustable tables

Office Furniture Work Package
7th floor

Panel matrix-C
54" Panel
Base Height + tackable fabric Add-On with frame,
(Double sided) access for the data and power base feeds

Panel matrix-B
24"and 30" Panels
Base Height + tackable fabric Add-On with frame,
Non-Powered

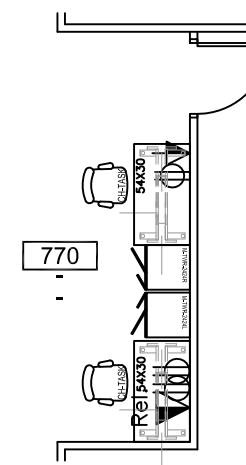
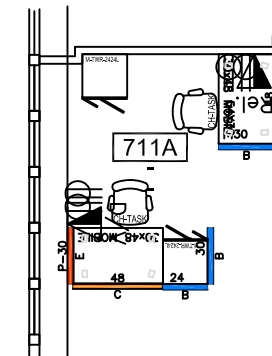
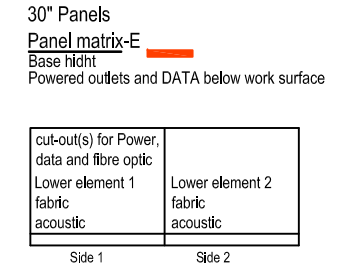
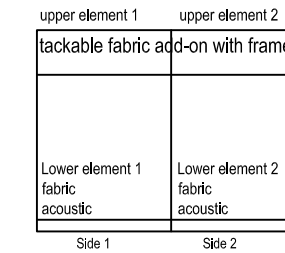
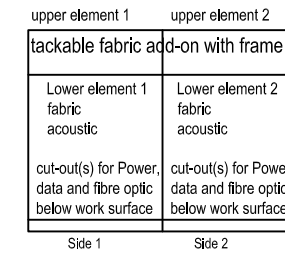

Office Furniture Work Package 11th floor

List of products from each 1A & 1B

Name	QNT.	Size	Material	Panel Matrix	Location
Panels powered	3	54"H X54"W	54"w Base Height acoustic Panels + tackable fabric add-on with frame	panel matrix C	1112
	2	54"H X30"W	30"w Base Height acoustic Panels + tackable fabric add-on with frame	panel matrix C	1112
	1	54Hx36"W	36"w Base Height acoustic Panels + tackable fabric add-on with frame	panel matrix C	1112
	4	34Hx54"W	Base Height acoustic, powered	panel matrix E	1112, 1155
	1	34Hx24"W	Base Height acoustic, powered	panel matrix E	1155
Panels non powered	1	34Hx30"W	Base Height acoustic, non powered	panel matrix A	1155
	1	34Hx24"W	Base Height acoustic, non powered	panel matrix A	1155
CAT 1b Personal Storage locker	13 Left	51.2"Hx24"Wx24"D	File, File, Metal, Left Ward., Rect Pull, keyed		
	4 Right	51.2"Hx24"Wx24"D	File, File, Metal, Right Ward., Rect Pull, keyed		

List of products Cat 5(E)

Item No.	QTY.	Cat 5 (E)	material
1	17	Power Module, Power/USB, Desk Edge Clamp Line #20 - - CAT 5 GOCUID #5PMOWKSMTACUSBXXXX Case Finish: 83 - Very White	
2	17	monitor arm, for dual monitors, edge clamp mount	

List of products Cat 2-HA tables

Item No.	QTY.	Cat 2 (Freestanding Height Adjustable Desk/Table Products)	Size	material	location
1	13	seat/stand range height adjustable work surface electrically assisted, seat/stand range 23"-48.7"	30"Wx54"L	laminate	1112, 1116, 1155
2	4	seat/stand range height adjustable work surface electrically assisted, seat/stand range 23"-48.7"	30"Wx48"L	laminate	1180, 1178

List of products miscellaneous

Other	QTY.	Location	Size	Requirements
Task Chairs	17	70CHNBMLAASSALMTTCUBF		
Horizontal Cable management system	17		24"Lx3.6"Diameter	Should be installed underneath all Height Adjustable tables
Base feed for power	2	1112, 1155		
Base feed for data	2	1112, 1155		

Office Furniture Work Package 11th floor

Panel matrix-C

54", 30", 36" Panels

Base Height + tackable fabric Add-On with frame,
Powered outlet(s) and DATA below work surface
(Double sided) access for the data and power base feeds

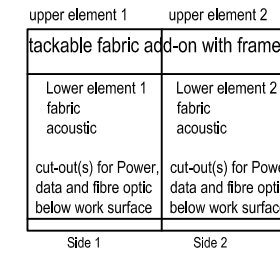

Panel matrix-A

24" and 30" Panels

Base Height,
Non-Powered

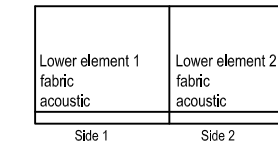

54", 24" Panels

Panel matrix-E

Base Height,
Powered outlets and DATA below work surface

