



EC 50180 – Official Seal
EC 50190 – Short Ballot Box Seal
EC 50200 – Long Ballot Box Seal

ANNEX A
Statement of Work

SPECIFICATIONS SHEET

Item 1 – EC 50180

1. DESCRIPTION OF DELIVERABLE

1.01. The official seals are used as a security measure to prevent tampering and to protect the integrity of the election process. They are used to seal paper envelopes and plastic bags. This production consists of security seals/labels with tamper-evident slit in the form of an X. A permanent adhesive is required and must be strong enough to prevent the seal/label, once attached, from being removed without damaging the paper envelope and/or plastic bag.

2. REFERENCE NUMBER: EC 50180 (10/2018)

3. TITLE: Official Seal

4. QUANTITIES

4.01. 150,000 packages of 25 – Total quantity 3,750,000 seals

4.02. OVERS

- a) **No over / No under**
- b) Elections Canada will not pay an invoice for items received in excess of the quantity stipulated in this specification, nor will it pay the full amount when items are sent in lower quantities than requested. It is the Supplier's responsibility to ensure that items are shipped in the correct quantities.

5. PRODUCTION DETAILS

5.01. **CARRIER SHEET DIMENSIONS:** 6.5" wide x 4" high (16.51 cm x 10.16 cm).

5.02. **SEAL DIMENSIONS:** Kiss cut to 5 15/16" wide x 3 3/8" high (15.08125 cm x 8.5725 cm) - with rounded corners.

5.03. **INK:** Black, 70% in coverage. No bleeds.

- a) All text and Elections Canada logo prints in black
- b) Text prints on carrier sheet and on label

5.04. **SECURITY SLIT:** Each seal/label **must** have a die cut security slit in the center of the seal in the form of an X.

- a) The kiss cut must not exceed the black border of the seal/label.

- b) The seal/label does not need to display a message if tampered with but must break down/tear to ensure inability of re-sticking the same label.
- c) Refer to **APPENDIX A-1** for the location of the die cut slit.

5.05. **NUMBERING:** The official seal **does not** require numbering.

5.06. **STOCK:** Semi-gloss high coat weight or equivalent with permanent self-adhesive.

5.07. **ADHESIVE:** Adhesive/glue must be very aggressive. Each seal/label must sticks aggressively and permanently to the paper envelope or plastic bag it was affixed on.

5.08. **SHELF LIFE:** The supplier must guarantee a shelf life of adhesive for a minimum of 2 years.

5.09. **BINDERY:** Stapled in packages of twenty-five (25) seals

- a) One stitch centered on the left edge of carrier sheet
- b) **IMPORTANT:** The stitch must be on carrier sheet and NOT on seal/label.

6. IMAGE

To be affixed to the envelopes so marked
À apposer sur les enveloppes portant des indications à cet effet

Official Seal / Sceau officiel EC 50180 (10/2018)

Election Officer / Fonctionnaire électoral		Signature
<input type="checkbox"/>	Deputy returning officer / scrutateur	
<input type="checkbox"/>	Poll clerk / greffier du scrutin	
<input type="checkbox"/>	Returning officer / directeur du scrutin	
<input type="checkbox"/>	Assistant returning officer / directeur adjoint du scrutin	
<input type="checkbox"/>	Service point supervisor / superviseur de point de service	
<input type="checkbox"/>	Other election officer / autre fonctionnaire électoral	

Candidates and/or representatives/agents may also sign below
Les candidats et/ou représentants ou agents peuvent aussi signer ci-dessous

1.	3.
2.	4.

7. COMPONENT

7.01. High resolution PDF supplied. A sample of a package of 25 official seals from the previous production is available upon request.

8. PROOF

8.01. The winning supplier must provide two sample sheets of proposed stock with adhesive for testing purposes.

8.02. A set of high and low resolution proof that meets the requirements described above before production is required.

8.03. Please send to Material Management, Elections Canada, OFG Directorate, 30 Victoria Street, Gatineau (QC) K1A 0M6. Attention: Project Authority

9. PACKAGING

- 9.01. The supplier will be responsible for providing the corrugated shipping boxes.
- 9.02. Package in corrugated boxes. Each box not to weigh more than 35 lbs.
- 9.03. **Packaging labels:** Clearly identify each box as to the content in a minimum 20 pts type size as follows:

<p><i>EC 50180 (10/2018)</i> <i>Official Seals / Sceaux officiels</i> <i>Qty — XX packages of 25 seals</i></p>

- 9.04. **NOTE:** Labeling of items going to the Distribution Centre must be exactly as indicated. If not, they will not be accepted.

10. SHIPPING INSTRUCTIONS

10.01. Skids

- a) Ship on non-returnable shipping skids measuring 48" wide by 42" deep, have three stringers with three blocks, each 48" in length;
- b) Each skid **must not** be higher than 54", including the skid;
- c) Each skid **must** have bottom boards and **must** be a **brewery-type skid (4 way entry)**;
- d) Each skid **must** be shrink-wrapped;
- e) The material **must** be accessible by hand-held hydraulic pallet movers;
- f) Items shipped to 100-440 Coventry that are not on requested skids will not be accepted upon delivery; and
- g) Refer to **APPENDIX B-1** for a diagram and specifications of a brewery-type skid.

10.02. Delivery

- a) Address of EC warehouse: Elections Canada, Distribution Centre, 100-440 Coventry Road, Ottawa, Ontario, K1K 2Y5;
- b) Delivery hours at 100-400 Coventry Road are 8:00 a.m. to 12:00 (noon) and 1:00 p.m. to 4:00 p.m. Ottawa time, Monday to Friday, excluding statutory holidays; and
- c) A written notice that a load is coming is appreciated. Please send to:
DistributionCentre-Centrededistribution@elections.ca

11. MANDATORY DELIVERY DATE

11.01. **On or before, but no later than September 30, 2020. This is a firm delivery date.**

11.02. Provided prior approval by the Project Authority, partial deliveries will be accepted, but entire production must be delivered by **September 30, 2020**.

12. ADDITIONAL INFORMATION

12.01. No change in in these specifications will be accepted unless approved by the project authority.

12.02. Elections Canada must be informed of the cost of any author's alterations as soon as possible. A contract amendment must be made as soon as any changes affecting cost occur.

12.03. The supplier must return to Elections Canada a final electronic file properly identified with all or any corrections made at the proofing stage before invoices are approved for payment.

APPENDIX A-1 — Sample of seal showing kiss cut (blue lines)

**To be affixed to the envelopes so marked
À apposer sur les enveloppes portant des indications à cet effet**

		Official Seal / Sceau officiel	EC 50180 (10/2018)
Election Officer / Fonctionnaire électoral		Signature	
<input type="checkbox"/>	Deputy returning officer / scrutateur		
	Poll clerk / greffier du scrutin		
<input type="checkbox"/>	Returning officer / directeur du scrutin		
	Assistant returning officer / directeur adjoint du scrutin		
<input type="checkbox"/>	Service point supervisor / superviseur de point de service		
<input type="checkbox"/>	Other election officer / autre fonctionnaire électoral		
Candidates and/or representatives/agents may also sign below Les candidats et/ou représentants ou agents peuvent aussi signer ci-dessous			
1.		3.	
2.		4.	

APPENDIX B-1 – Diagram and specifications of a brewery-type skid

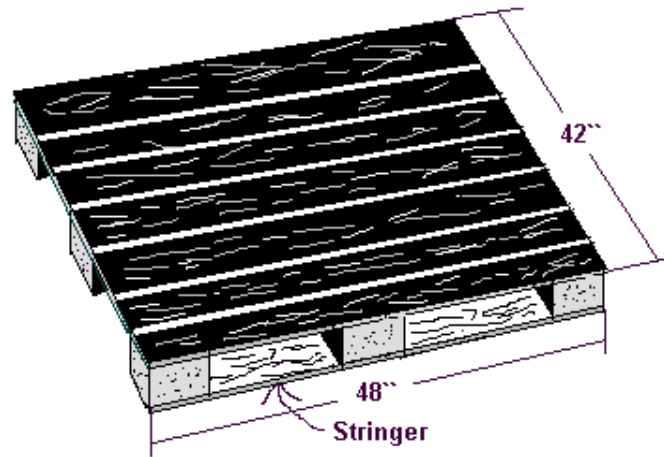

Stringer - SOLID BLOCKS - 4" X 6" X 3" High



Item 2 – EC 50190**13. DESCRIPTION OF DELIVERABLE**

- 13.01. The short seal is used to seal the short sides of the cardboard ballot box, on the top and bottom of the box. Before voting begins, the ballot box is sealed with the seals by election officials hired to work at a polling station. After the close of the poll, the ballot box is opened (by breaking the seals on the top) for the counting of ballots. Once the count is completed, the ballots and other documents are placed in the ballot box and a new seal is affixed over the first seal to reseal the ballot box. The ballot box is then taken to the local Elections Canada office and kept sealed until the results are validated. The ballot box may be reopened and resealed more than once if a judicial recount is required.
- 13.02. Refer to **APPENDIX A-2** for a diagram showing the location of the short seals.

14. REFERENCE NUMBER: EC 50190 (10/2018)**15. TITLE: Short Ballot Box Seal****16. QUANTITIES**

- 16.01. 146,000 packages of 10 fan-folded seals – Total 1,460,000 short seals

16.02. OVERS

- a) **No over / No under**
- b) Elections Canada will not pay an invoice for items received in excess of the quantity stipulated in this specification, nor will it pay the full amount when items are sent in lower quantities than requested. It is the Supplier's responsibility to ensure that items are shipped in the correct quantities.

17. PRODUCTION DETAILS

- 17.01. **CARRIER SHEET:** A carrier sheet is made of ten (10) seals, with a perforation between each seal and fan-folded in an accordion shape.
- 17.02. **CARRIER SHEET DIMENSIONS:** 9" wide x 40" high (22.86 cm x 101.6 cm).
- 17.03. **INDIVIDUAL CARRIER SHEET DIMENSIONS:** 9" wide x 4" high (22.86 cm x 10.16 cm).
- 17.04. **SEAL DIMENSIONS:** 8" wide x 3" high (20.32 cm x 7.62 cm)
- with rounded corners.
- a) Refer to **APPENDIX B-2** for a diagram of a carrier sheet with ten (10) seals.

- 17.05. **INK:** Black. No bleeds.
- Text, Elections Canada logo and item reference number prints in black on the carrier sheet.
 - No printing on seal itself.
- 17.06. **NUMBERING:** The short ballot box seal **does not** require numbering.
- 17.07. **OPERATION:** Kiss cut each seal to 8" wide x 3" high (20.32 cm x 7.62 cm) for seal with round corners.
- Also has a U-shaped thumb notch 1.25" wide x 1.125" high (3.175 cm x 286 cm), centred at the bottom of the seal.
 - NOTE:** A security die-cut is not required for the short seal.
- 17.08. **STOCK:** Laser cut sheets, 3Mil, Matte, White, Permanent Adhesive or equivalent.
- 17.09. **ADHESIVE:** Adhesive/glue must be very aggressive.
- Refer to **Section 18 – Special Instructions** for details on usage of seals.
- 17.10. **BINDERY:** Fan folded on the 9" side (22.86 cm), each carrier sheet includes 10 short seals.

18. SPECIAL INSTRUCTIONS

- 18.01. These seals are used as a security measure to prevent tampering and to protect the integrity of the electoral process. Seals must stay affixed for the duration of the Election Day (12 hours) and must not curl (come off). If removed, the seals must break down/tear to ensure inability of re-sticking the same label. Tests have been conducted and have shown that any attempt to remove the seals with an aggressive permanent adhesive would deteriorate the surface of the ballot box.

19. IMAGE

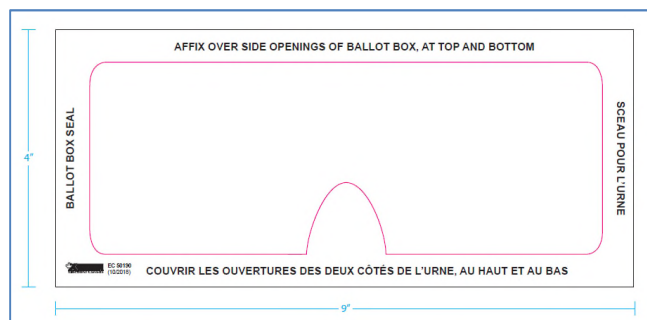

20. COMPONENT

20.01. High resolution PDF supplied. A sample of a package of 10 short seals from the previous production is available upon request.

21. PROOF

21.01. The winning supplier must provide two sample sheets with adhesive for testing purposes.

21.02. A set of high and low resolution proof that meets the requirements described above before production is required.

21.03. Please send to Material Management, Elections Canada, OFG Directorate, 30 Victoria Street, Gatineau (QC) K1A 0M6. Attention: Project Authority

22. PACKAGING

22.01. The supplier will be responsible for providing the corrugated shipping boxes.

22.02. Package in corrugated boxes. Each box not to weigh more than 35 lbs.

22.03. **Packaging labels:** Clearly identify each box as to the content in a minimum 20 pts type size as follows:

<p style="text-align: center;"><i>EC 50190 (10/2018)</i> <i>Short Ballot Box Seals / Petits sceaux pour l'urne</i> <i>Qty — XX packages of 10 short seals</i></p>
--

22.04. **NOTE:** Labeling of items going to the Distribution Centre must be exactly as indicated. If not, they will not be accepted.

23. SHIPPING INSTRUCTIONS

23.01. Skids

- a) Ship on non-returnable shipping skids measuring 48" wide by 42" deep, have three stringers with three blocks, each 48" in length;
- b) Each skid **must not** be higher than 54", including the skid;
- c) Each skid **must** have bottom boards and **must** be a **brewery-type skid (4 way entry)**;
- d) Each skid **must** be shrink-wrapped;
- e) The material **must** be accessible by hand-held hydraulic pallet movers;
- f) Items shipped to 100-440 Coventry that are not on requested skids will not be accepted upon delivery; and

- g) Refer to **APPENDIX C-2** for a diagram and specifications of a brewery-type skid.

23.02. **Delivery**

- a) Address of EC warehouse: Elections Canada, Distribution Centre, 100-440 Coventry Road, Ottawa, Ontario, K1K 2Y5;
- b) Delivery hours at 100-400 Coventry Road are 8:00 a.m. to 12:00 (noon) and 1:00 p.m. to 4:00 p.m. Ottawa time, Monday to Friday, excluding statutory holidays; and
- c) A written notice that a load is coming is appreciated. Please send to: DistributionCentre-Centrededistribution@elections.ca

24. MANDATORY DELIVERY DATE

24.01. **On or before, but no later than September 30, 2020. This is a firm delivery date.**

24.02. Provided prior approval by the Project Authority, partial deliveries will be accepted, but entire production must be delivered by **September 30, 2020**.

25. ADDITIONAL INFORMATION

25.01. No change in in these specifications will be accepted unless **approved** by the project authority.

25.02. Elections Canada must be informed of the cost of any author's alterations as soon as possible. A contract amendment must be made as soon as any changes affecting cost occur.

25.03. The supplier must return to Elections Canada a final electronic file properly identified with all or any corrections made at the proofing stage before invoices are approved for payment.

APPENDIX A-2 — Diagram showing seals location (EC 50190 – short seals)

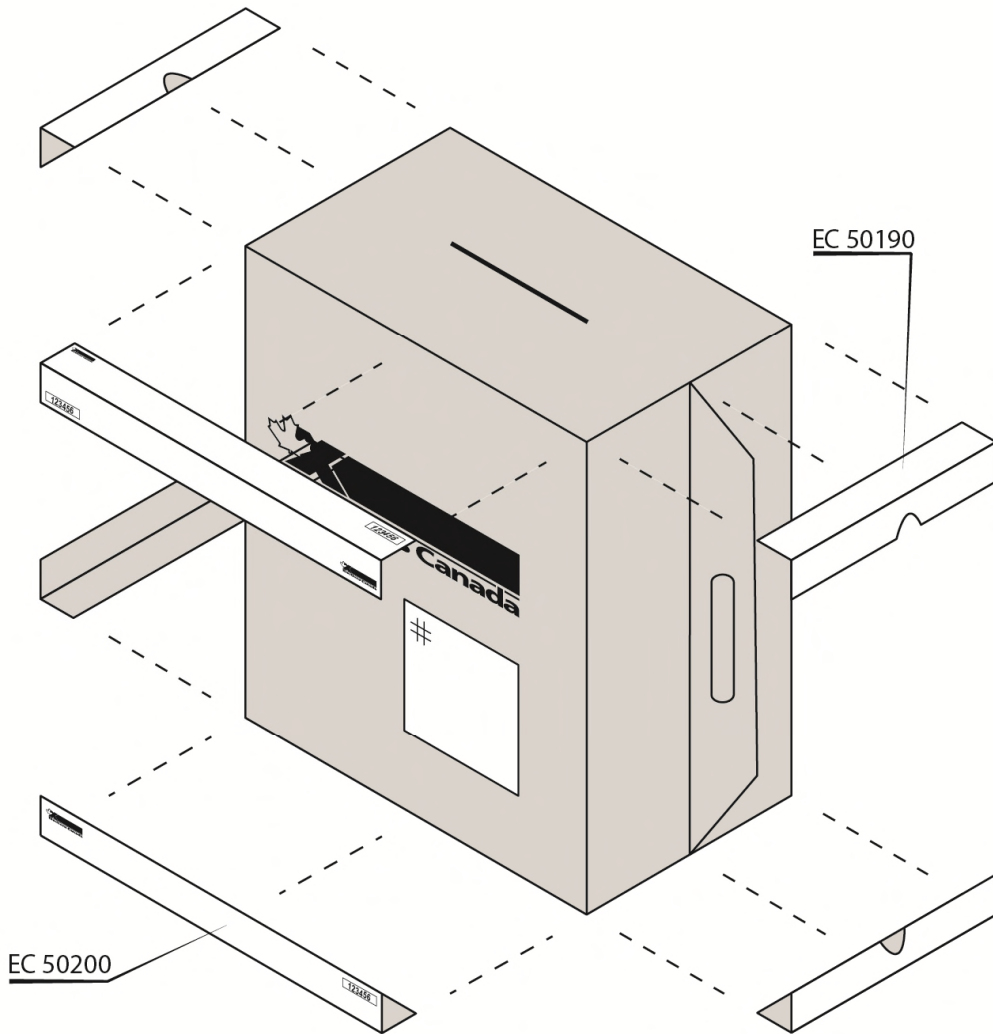

EC 50190 – Short seals

EC 50200 – Long seals

APPENDIX B-2 — Diagram of a carrier sheet with 10 seals

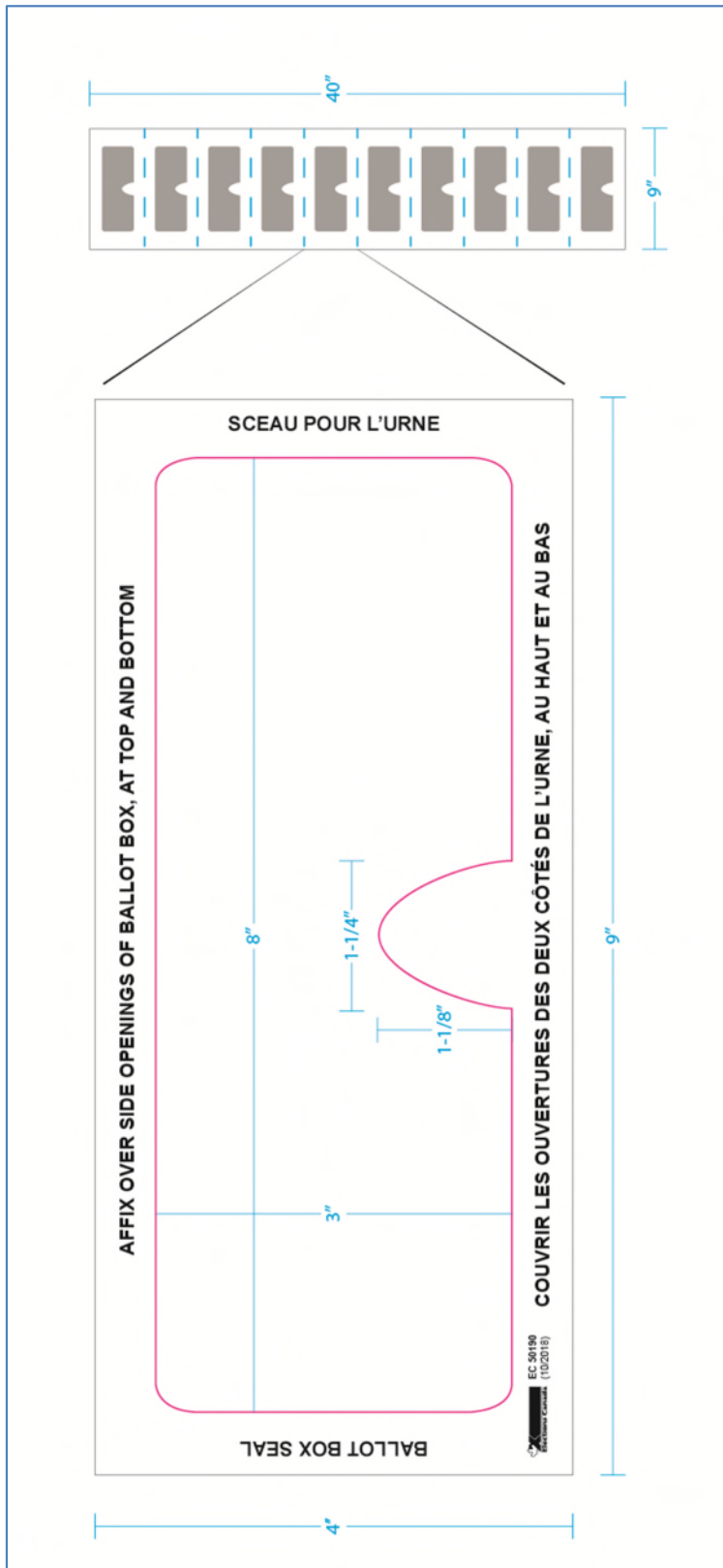

APPENDIX C-2 – Diagram and specifications of a brewery-type skid

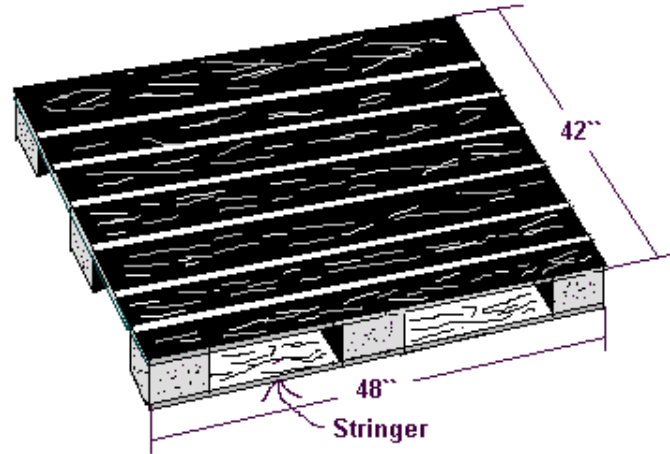

Stringer - SOLID BLOCKS - 4" X 6" X 3" High



Item 3 – EC 50200**26. DESCRIPTION OF DELIVERABLE**

- 26.01. The long seal is used to seal the top and bottom long edges of the cardboard ballot box. The serial number on the long seal is recorded to ensure the security of ballots and supplies in the ballot box. Before voting begins, the ballot box is sealed with two long seals as well as 4 short seals by election officials hired to work at a polling station. After the close of the poll, the ballot box is opened (by breaking the seals) for the counting of ballots and once the count is completed, the ballots and other documents are placed in the box and resealed by affixing another seal on top of the initial seal. The boxes are returned to the local Elections Canada office and kept sealed until the results are validated. In a situation where a judicial recount is required, the ballot box is reopened and resealed more than once.
- 26.02. Refer to **APPENDIX A-3** for a diagram showing the long seal location.

27. REFERENCE NUMBER: EC 50200 (10/2018)**28. TITLE: Long Ballot Box Seal****29. QUANTITIES**

- 29.01. 138,000 packages of 5 fan-folded seals - Total 690,000 long seals

29.02. OVERS

- a) **No over / No under**
- b) Elections Canada will not pay an invoice for items received in excess of the quantity stipulated in this specification, nor will it pay the full amount when items are sent in lower quantities than requested. It is the Supplier's responsibility to ensure that items are shipped in the correct quantities.

30. PRODUCTION DETAILS

- 30.01. **CARRIER SHEET:** A carrier sheet is made of five (5) seals, with a perforation between each seal and fan-folded in an accordion shape.
- 30.02. **CARRIER SHEET DIMENSION:** 15" wide x 20" high (38.1 cm x 50.8 cm).
- 30.03. **INDIVIDUAL CARRIER SHEET DIMENSION:** 15" wide x 4" high (38.1 cm x 10.16 cm).
- 30.04. **SEAL DIMENSION:** 14" wide x 3" high (35.56 cm x 7.62 cm).
- a) Refer to **APPENDIX B-3** for a diagram of a carrier sheet with 5 fan-folded seals.

- 30.05. **INK:** Black. No bleed.
- a) Text, item reference number and revision date prints in black on the individual carrier sheet.
 - b) The Elections Canada logo, numbering and the box outline in black on seal itself.
- 30.06. **NUMBERING:** Start from **741,002 and ends at 1,426,001** consecutively numbered.
- a) Each seal (in a package of 5) must have a unique and different number,-so 5 consecutive numbers per package.
 - b) Same number is printed twice on the long seal with a solid black outline (box).
 - c) Location of numbering:
 - o Right top approximately 0.625" (5/8" or 1.5875 cm) from top, 0.625" (5/8" or 1.5875 cm) from the right edge.
 - o Left bottom approximately 1.875" (1-7/8" or 4.7625 cm) from left top and 0.625" (5/8" or 1.5875 cm) from left edge.
 - o Numbers to be 0.3125" (5/16" or 0.79375 cm) high or in a 32 pts font size. The winning supplier can match font size to sample provided.
- 30.07. **OPERATION:** Kiss cut 14" wide x 3" high (38.1 cm x 10.16 cm) for seal with round corners.
- 30.08. **SECURITY CUT:** The long seal must have a V-shape kiss cut of 2" long (5.08 cm) at each end of the seal. V-shape d slits cutting marks do not print and must not touch the printed logo.
- 30.09. **STOCK:** Laser cut sheets, 3Mil, Matte, White, Permanent Adhesive or equivalent.
- 30.10. **ADHESIVE:** Adhesive/glue must be very aggressive.
- a) Refer to **Section 31 – Special Instructions** for details on usage of the seals.
- 30.11. **BINDERY:** Fan folded on the 15" side (38.1 cm), each carrier sheet includes 5 long seals.

31. SPECIAL INSTRUCTIONS

- 31.01. These seals are used as a security measure to prevent tampering and to protect the integrity of the election process. The seals must stay affixed during the duration of Election Day (12 hrs) and must not curl. The die-cut security slit in the form of V-shape at both ends of the label must tear if the seal/label is removed to ensure inability of re-sticking the same label. Tests have been conducted and showed that

any attempt to remove the seals with aggressive permanent adhesive would deteriorate the surface of the ballot box.

32. IMAGE

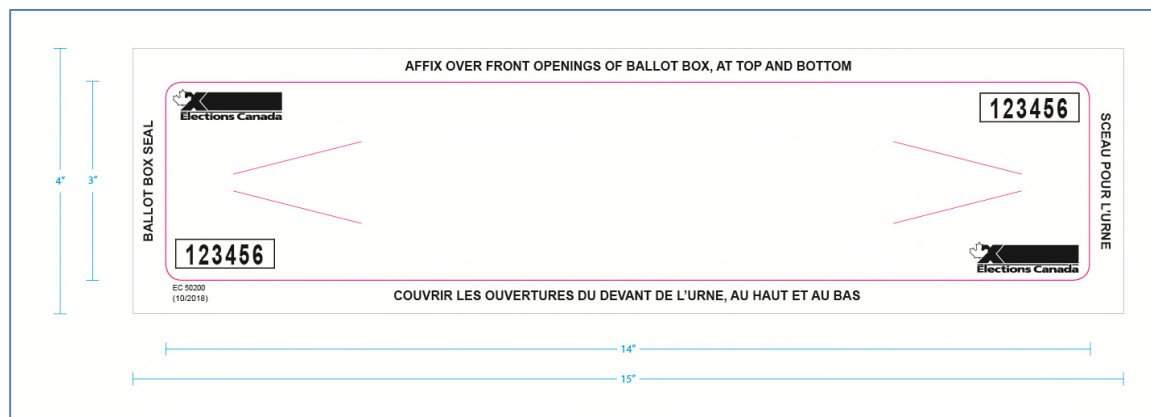

33. COMPONENT

33.01. High resolution PDF supplied. A sample of a package of 5 long seals from the previous production is available upon request.

34. PROOF

34.01. The winning supplier must provide two sample sheets with adhesive for testing purposes.

34.02. A set of high and low resolution proof that meets the requirements described above before production is required.

34.03. Please send to Material Management, Elections Canada, OFG Directorate, 30 Victoria Street, Gatineau (QC) K1A 0M6. Attention: Project Authority

35. PACKAGING

35.01. The supplier will be responsible for providing the corrugated shipping boxes.

35.02. Package in corrugated boxes. Each box not to weigh more than 35 lbs.

35.03. **Packaging labels:** Clearly identify each box as to the content in a minimum 20 pts type size as follows:

EC 50200 (10/2018)
Long Ballot Box Seals / Longs sceaux pour l'urne
Qty — XX packages of 5 long seals

35.04. **NOTE:** Labeling of items going to the Distribution Centre must be exactly as indicated. If not, they will not be accepted.

36. SHIPPING INSTRUCTIONS**36.01. Skids**

- a) Ship on non-returnable shipping skids measuring 48" wide by 42" deep, have three stringers with three blocks, each 48" in length;
- b) Each skid **must not** be higher than 54", including the skid;
- c) Each skid **must** have bottom boards and **must** be a **brewery-type skid (4 way entry)**;
- d) Each skid **must** be shrink-wrapped;
- e) The material **must** be accessible by hand-held hydraulic pallet movers;
- f) Items shipped to 100-440 Coventry that are not on requested skids will not be accepted upon delivery; and
- g) Refer to **APPENDIX C-3** for a diagram and specifications of a brewery-type skid.

36.02. Delivery

- a) Address of EC warehouse: Elections Canada, Distribution Centre, 100-440 Coventry Road, Ottawa, Ontario, K1K 2Y5;
- b) Delivery hours at 100-400 Coventry Road are 8:00 a.m. to 12:00 (noon) and 1:00 p.m. to 4:00 p.m. Ottawa time, Monday to Friday, excluding statutory holidays; and
- c) A written notice that a load is coming is appreciated. Please send to: DistributionCentre-Centrededistribution@elections.ca

37. MANDATORY DELIVERY DATE

37.01. On or before, but no later than September 30, 2020. This is a firm delivery date.

37.02. Provided prior approval by the Project Authority, partial deliveries will be accepted, but entire production must be delivered by **September 30, 2020**.

38. ADDITIONAL INFORMATION

38.01. No change in in these specifications will be accepted unless approved by the project authority.

38.02. Elections Canada must be informed of the cost of any author's alterations as soon as possible. A contract amendment must be made as soon as any changes affecting cost occur.

- 38.03. The supplier must return to Elections Canada a final electronic file properly identified with all or any corrections made at the proofing stage before invoices are approved for payment.

APPENDIX A-3 — Diagram showing seals location

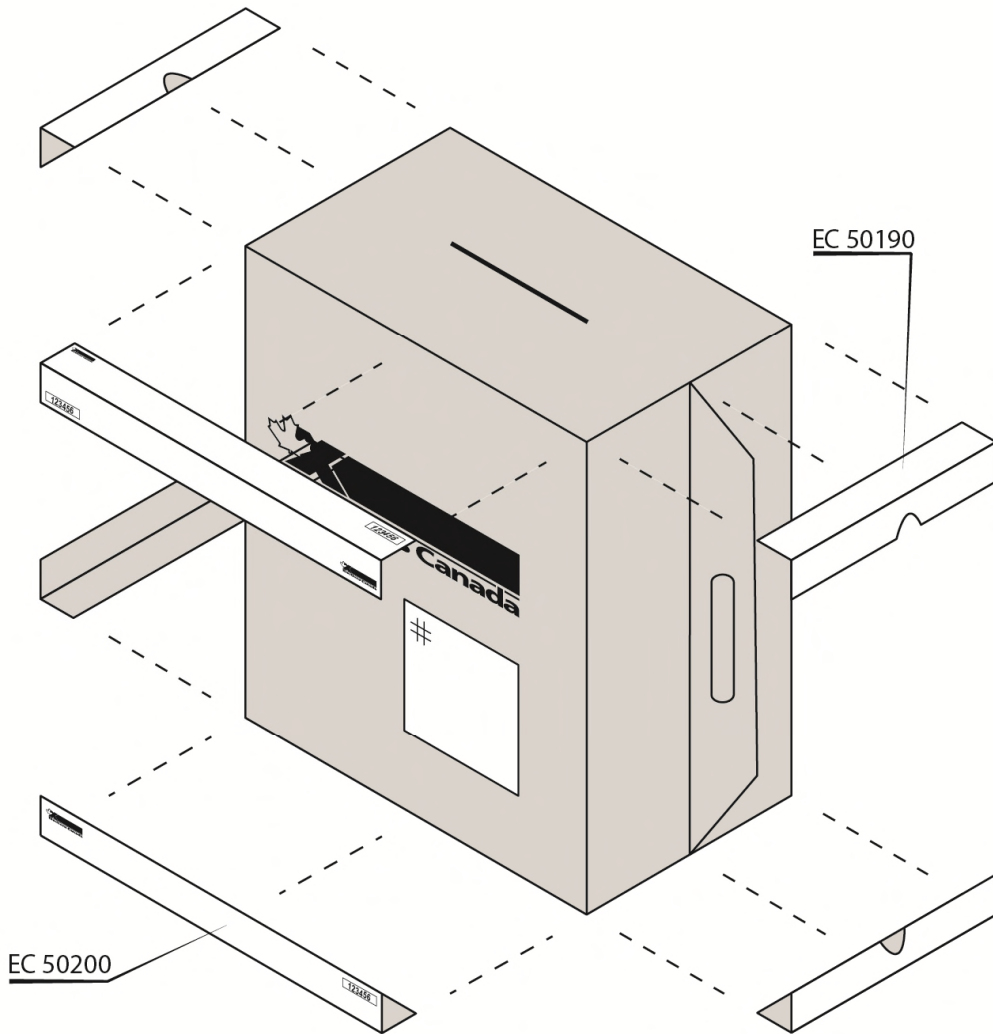

EC 50190 – Short seal

EC 50200 – Long seal

APPENDIX B-3 — Diagram of a carrier sheet with 5 long seals

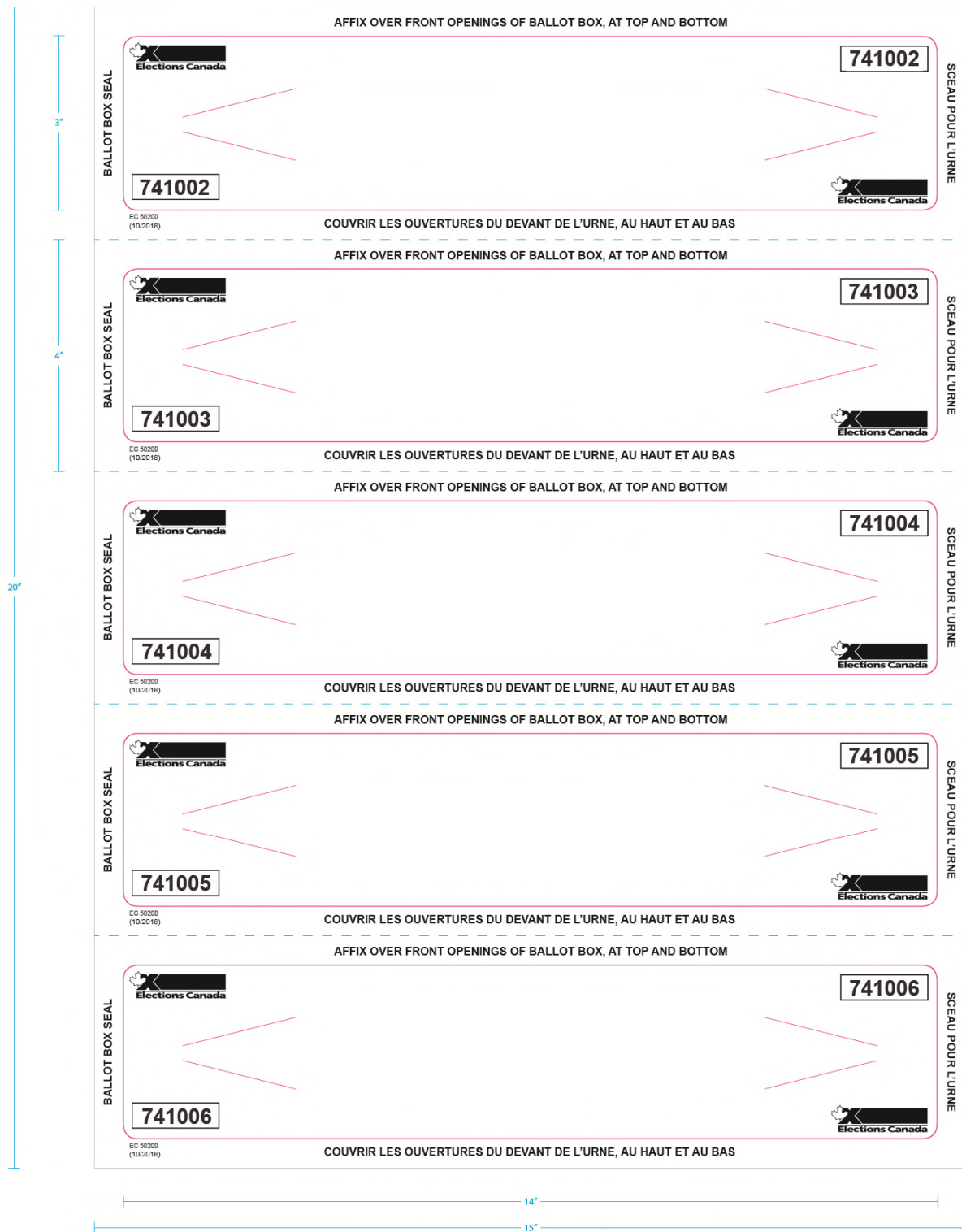

APPENDIX C-3 – Diagram and specifications of a brewery-type skid

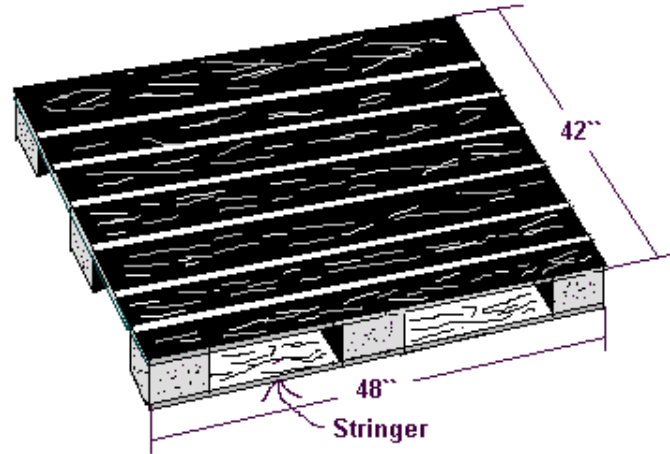

Stringer - SOLID BLOCKS - 4" X 6" X 3" High





EC 50180 – Official Seal
EC 50190 – Short Ballot Box Seal
EC 50200 – Long Ballot Box Seal

ANNEX B

Pricing Table

Annex B – Pricing Table

The Contractor will be paid in accordance with the firm all inclusive rates outlined below for the services outlined in Annex A – Statement of Work. Pricing is for the full period of the contract and does not include applicable sales tax.

The Firm price must include the cost of skids and transportation fee.

Initial Period: from Contract Award to March 31, 2022

Item #	Item Description	Unit of measure	Quantity	Firm Unit Price	Firm Extended Price
1.	EC 50180 – Official Seal *Purchase Order # insert at contract award	Package of 25	150,000 packages	\$ insert at contract award per package	\$ [insert at contract award]
Maximum cost of any author’s alterations (AA’s)					\$ [insert at contract award]
2.	EC 50190 – Short Ballot Box Seal *Purchase Order # insert at contract award	Package of 10	146,000 packages	\$ insert at contract award per package	\$ [insert at contract award]
Maximum cost of any author’s alterations (AA’s)					\$ [insert at contract award]
3.	EC 50200 – Long Ballot Box Seal *Purchase Order # insert at contract award	Package of 5	138,000 packages	\$ insert at contract award per package	\$ [insert at contract award]
Maximum cost of any author’s alterations (AA’s)					\$ [insert at contract award]
Total Cost					\$ [insert at contract award]

TO A MAXIMUM OF \$insert at contract award (applicable taxes extra)

All payments are subject to Government Audit.

***For invoicing purposes, please ensure to indicate on the invoice the PO number related to each item.**

No Overs / No Unders

Elections Canada will not pay an invoice for items received in excess of the quantity stipulated in Annex A – Statement of Work, nor will it pay the full amount when items are sent in lower quantities than requested. It is the supplier’s responsibility to ensure that items are shipped in the correct quantities.

Option for Additional Quantities during Initial Period (from Contract Award to March 31, 2022):

	A	B	C	D
Item #	Item Description	Unit of measure	Quantity	Firm Unit Price
1.	EC 50180 – Official Seal	Package of 25	25,000 to 50,000	\$ [insert at contract award] per package
1.	EC 50180 – Official Seal	Package of 25	50,001 to 100,000	\$ [insert at contract award] per package
1.	EC 50180 – Official Seal	Package of 25	100,001 to 150,000	\$ [insert at contract award] per package

	A	B	C	D
Item #	Item Description	Unit of measure	Quantity	Firm Unit Price
2.	EC 50190 – Short Ballot Box Seal	Package of 10	25,000 to 50,000	\$ [insert at contract award] per package
2.	EC 50190 – Short Ballot Box Seal	Package of 10	50,001 to 100,000	\$ [insert at contract award] per package

2.	EC 50190 – Short Ballot Box Seal	Package of 10	100,001 to 146,000	\$ [insert at contract award] per package
----	----------------------------------	---------------	--------------------	---

	A	B	C	D
Item #	Item Description	Unit of measure	Quantity	Firm Unit Price
3.	EC 50200 – Long Ballot Box Seal	Package of 5	25,000 to 50,000	\$ [insert at contract award] per package
3.	EC 50200 – Long Ballot Box Seal	Package of 5	50,001 to 100,000	\$ [insert at contract award] per package
3.	EC 50200 – Long Ballot Box Seal	Package of 5	100,001 to 138,000	\$ [insert at contract award] per package

Option Period: April 1, 2022 to March 31, 2024

	A	B	C	D
Item #	Item Description	Unit of measure	Quantity	Firm Unit Price
1.	EC 50180 – Official Seal	Package of 25	25,000 to 50,000	\$ [insert at contract award] per package
1.	EC 50180 – Official Seal	Package of 25	50,001 to 100,000	\$ [insert at contract award] per package
1.	EC 50180 – Official Seal	Package of 25	100,001 to 150,000	\$ [insert at contract award] per package

	A	B	C	D
Item #	Item Description	Unit of measure	Quantity	Firm Unit Price
2.	EC 50190 – Short Ballot Box Seal	Package of 10	25,000 to 50,000	\$ [insert at contract award] per package
2.	EC 50190 – Short Ballot Box Seal	Package of 10	50,001 to 100,000	\$ [insert at contract award] per package
2.	EC 50190 – Short Ballot Box Seal	Package of 10	100,001 to 150,000	\$ [insert at contract award] per package

	A	B	C	D
Item #	Item Description	Unit of measure	Quantity	Firm Unit Price
3.	EC 50200 – Long Ballot Box Seal	Package of 5	25,000 to 50,000	\$ [insert at contract award] per package

3.	EC 50200 – Long Ballot Box Seal	Package of 5	50,001 to 100,000	\$ [insert at contract award] per package
3.	EC 50200 – Long Ballot Box Seal	Package of 5	100,001 to 150,000	\$ [insert at contract award] per package

Annex C
General Conditions
Goods

Article 1 Interpretation

Section 1.01 Definitions

1.01.01 In the Contract, unless the context otherwise requires:

- “Articles of Agreement” means the clauses and conditions incorporated in full text in the body of the Contract; it does not include these general conditions, any supplemental general conditions, annexes, the Contractor’s bid or any other document;
- “Canada” means Her Majesty the Queen in right of Canada;
- “Contract” means the Articles of Agreement, these general conditions, any supplemental general conditions, annexes and any other document specified or referred to as forming part of the Contract, all as amended by agreement of the Parties from time to time;
- “Contracting Authority” means the person designated by that title in the Contract, or by notice to the Contractor, to act as Elections Canada’s representative to manage the Contract;
- “Contractor” means the person, entity or entities named in the Contract to supply goods, services or both to Elections Canada;
- “Contract Price” means the amount stated in the Contract to be payable to the Contractor for the Work, exclusive of applicable sales tax;
- “Cost” means cost determined according to Contract Cost Principles 1031-2 as revised to the date of the bid solicitation or, if there was no bid solicitation, the date of the Contract;
- “EC Property” means anything supplied to the Contractor by or on behalf of Elections Canada for the purposes of performing the Contract and anything acquired by the Contractor in any manner in connection with the Work, the cost of which is paid by Elections Canada under the Contract;
- “Elections Canada” means the Chief Electoral Officer and any other person duly authorized to act on his behalf;

“Party”	means Elections Canada, the Contractor, or any other signatory to the Contract and “Parties” means all of them;
“Specifications”	means the description of the essential, functional or technical requirements of the Work in the Contract, including the procedures for determining whether the requirements have been met; and
“Work”	means all the activities, services, goods, equipment, matters and things required to be done, delivered or performed by the Contractor under the Contract.

Section 1.02 Powers of Elections Canada

All rights, remedies, powers and discretions granted or acquired by Elections Canada under the Contract or by law are cumulative, not exclusive.

Section 1.03 Status of the Contractor

The Contractor is an independent contractor engaged by Elections Canada to perform the Work. Nothing in the Contract is intended to create a partnership, a joint venture or an agency between Elections Canada and the other Party or Parties. The Contractor must not represent itself as an agent or representative of Elections Canada to anyone. Neither the Contractor nor any of its personnel is engaged as an employee or agent of Elections Canada. The Contractor is responsible for all deductions and remittances required by law in relation to its employees.

Section 1.04 Severability

If any provision of the Contract is declared by a court of competent jurisdiction to be unenforceable, that provision is to be either adjusted the minimum necessary to make it enforceable (if permitted by law) or stricken (if not). If adjusting or striking the unenforceable provision would result in failure of an essential purpose of this agreement, the entire agreement is to be held unenforceable. After an unenforceable provision is adjusted or stricken in accordance with this Section 1.04, the rest of the Contract is to remain in effect as written and the unenforceable provision is to remain as written in any circumstances other than those in which the provision is held to be unenforceable.

Section 1.05 Entire Agreement

The Contract constitutes the entire and only agreement between the Parties and supersedes all previous negotiations, communications and other agreements, whether written or oral, unless they are incorporated by reference in the Contract. There are no terms, covenants, representations, statements or conditions binding on the Parties other than those contained in the Contract.

Article 2 Conduct of the Work

Section 2.01 Representation and Warranties

- 2.01.01 The Contractor represents and warrants that:
- (a) it is competent to perform the Work;
 - (b) it has everything necessary to perform the Work, including the resources, facilities, labour, technology, equipment, and materials; and
 - (c) it has the necessary qualifications, including knowledge, skill, know-how and experience, and the ability to use them effectively to perform the Work.
- 2.01.02 The Contractor must:
- (a) perform the Work diligently and efficiently;
 - (b) except for EC Property, supply everything necessary to perform the Work;
 - (c) use, as a minimum, quality assurance procedures, inspections and controls generally used and recognized by the industry to ensure the degree of quality required by the Contract; and
 - (d) ensure that the Work is of proper quality, using appropriate material and workmanship and meets all the requirements of the Contract.
- 2.01.03 Unless the Contracting Authority orders the Contractor to suspend the Work or part of the Work pursuant to Article 18, the Contractor must not stop or suspend the Work or part of the Work pending the settlement of any dispute between the Parties about the Contract.
- 2.01.04 The Contractor must provide all reports that are required by the Contract and any other information that Elections Canada may reasonably require from time to time.
- 2.01.05 The Contractor is fully responsible for performing the Work. Elections Canada will not be responsible for any negative consequences or extra costs if the Contractor follows any advice given by Elections Canada unless the Contracting Authority provides the advice to the Contractor in writing and includes a statement specifically relieving the Contractor of any responsibility for negative consequences or extra costs that might result from following the advice.

Article 3 Work

Section 3.01 Specification

- 3.01.01 All Specifications provided by Elections Canada or on behalf of Elections Canada to the Contractor in connection with the Contract belong to Elections Canada and must be used by the Contractor only for the purpose of performing the Work.

3.01.02 If the Contract provides that Specifications furnished by the Contractor must be approved by Elections Canada, that approval will not relieve the Contractor of its responsibility to meet all requirements of the Contract.

Section 3.02 Condition of Material

Unless provided otherwise in the Contract, material supplied must be new and conform to the latest issue of the applicable drawing, specifications and part number that is in effect on the bid closing date or, if there was no bid solicitation, the date of the Contract.

Section 3.03 Replacement of Specific Individuals

3.03.01 If specific individuals are identified in the Contract to perform the Work, the Contractor must provide the services of those individuals unless the Contractor is unable to do so for reasons beyond its control.

3.03.02 If the Contractor is unable to provide the services of any specific individual identified in the Contract, it must provide a replacement with similar qualifications and experience. The replacement must meet the criteria used in the selection of the Contractor and be acceptable to Elections Canada. The Contractor must, as soon as possible, give notice to the Contracting Authority of the reason for replacing the individual and provide:

(a) the name, qualifications and experience of the proposed replacement; and

(b) proof that the proposed replacement has the required security clearance granted by Elections Canada or Canada, if applicable.

3.03.03 Upon receiving the notice of replacement of a specific individual, if the Contracting Authority determines that the replacement is acceptable to Elections Canada, the Contracting Authority shall send a written notice to the Contractor confirming its acceptance of the replacement.

3.03.04 The Contractor must not, in any event, allow performance of the Work by unauthorized replacement persons. The Contracting Authority may order that a replacement stop performing the Work. In such a case, the Contractor must immediately comply with the order and secure a further replacement in accordance with Subsection 3.03.02. The fact that the Contracting Authority does not order that a replacement stop performing the Work does not relieve the Contractor from its responsibility to meet the requirements of the Contract.

Section 3.04 Inspection and Acceptance of the Work

3.04.01 All the Work is subject to inspection and acceptance by Elections Canada. Inspection and acceptance of the Work by Elections Canada do not relieve the Contractor of its responsibility for defects or other failures to meet the requirements of the Contract.

Elections Canada will have the right to reject any Work that is not in accordance with the requirements of the Contract and require its correction or replacement at the Contractor's expense.

- 3.04.02 The Contractor must provide representatives of Elections Canada access to all locations where any part of the Work is being performed at any time during working hours. Representatives of Elections Canada may make examinations and such tests of the Work as they may think fit. The Contractor must provide all assistance and facilities, test pieces, samples and documentation that the representatives of Elections Canada may reasonably require for the carrying out of the inspection. The Contractor must forward such test pieces and samples to such person or location as Elections Canada specifies.
- 3.04.03 The Contractor must inspect and approve any part of the Work before submitting it for acceptance or delivering it to Elections Canada. The Contractor must keep accurate and complete inspection records that must be made available to Elections Canada on request. Representatives of Elections Canada may make copies and take extracts of the records during the performance of the Contract and for up to three years after the end of the Contract.

Section 3.05 Time of the Essence

It is essential that the Work be delivered within or at the time stated in the Contract.

Article 4 Subcontracts

Section 4.01 Consent

- 4.01.01 Except as provided in Subsection 4.01.02, the Contractor must obtain the written consent of the Contracting Authority before subcontracting or permitting the subcontracting of any part of the Work. A subcontract includes a contract entered into by any subcontractor at any tier to perform any part of the Work.
- 4.01.02 The Contractor is not required to obtain consent for subcontracts specifically authorized in the Contract. The Contractor may also without the consent of the Contracting Authority:
- (a) purchase "off-the-shelf" items and any standard articles and materials that are ordinarily produced by manufacturers in the normal course of business;
 - (b) subcontract any incidental services that would ordinarily be subcontracted in performing the Work;
 - (c) in addition to purchases and services referred to in Paragraphs (a) and (b), subcontract any part or parts of the Work to one or more subcontractors up to a total value of 40 percent of the Contract Price; and
 - (d) permit its subcontractors at any tier to make purchases or subcontract as permitted in

Paragraphs (a), (b) and (c).

Section 4.02 Subcontractor to be bound by Contract

- 4.02.01 In any subcontract other than a subcontract referred to in Paragraph 4.01.02(a), the Contractor must, unless the Contracting Authority agrees in writing, ensure that the subcontractor is bound by conditions compatible with and, in the opinion of the Contracting Authority, not less favourable to Elections Canada than the conditions of the Contract.
- 4.02.02 Even if Elections Canada consents to a subcontract, the Contractor is responsible for performing the Contract and Elections Canada is not responsible to any subcontractor. The Contractor is responsible for any matters or things done or provided by any subcontractor under the Contract and for paying any subcontractors for any part of the Work they perform.

Article 5 Payment

Section 5.01 Invoice Submission

- 5.01.01 Invoices must be submitted in the Contractor's name. The Contractor must submit invoices for each delivery or shipment; invoices must only apply to the Contract. Each invoice must indicate whether it covers partial or final delivery.
- 5.01.02 Invoices must show:
- (a) the date, the name and address of Elections Canada, item or reference numbers, deliverable and/or description of the Work, contract number, Procurement Business Number (PBN), the Contractor's business number for tax remission purposes and financial code(s);
 - (b) details of expenditures in accordance with the basis of payment provision in the Articles of Agreement, exclusive of applicable sales tax (such as item, quantity, unit of issue, unit price, fixed time labour rates and level of effort, subcontracts, as applicable);
 - (c) deduction for holdback, if applicable;
 - (d) the extension of the totals, if applicable; and
 - (e) if applicable, the method of shipment together with date, case numbers and part or reference numbers, shipment charges and any other additional charges.
- 5.01.03 Applicable sales tax must be specified on all invoices as a separate item together with the corresponding registration numbers issued by the appropriate tax authorities. All items that are zero-rated, exempt or to which no sales tax applies, must be identified as such on

all invoices.

- 5.01.04 By submitting an invoice, the Contractor certifies that the invoice is consistent with the Work delivered and is in accordance with the Contract.

Section 5.02 Payment Period

- 5.02.01 Provided that Elections Canada has received a duly signed original copy of the Contract, Elections Canada's standard payment period is 30 calendar days. The payment period will commence the date the invoice, in acceptable form and content, is received in accordance with the Contract or the date the Work is delivered in acceptable condition as required in the Contract, whichever is later. A payment is considered overdue on the 31st day following that date and interest will be paid automatically in accordance with Section 5.04 .
- 5.02.02 If the content of the invoice and its substantiating documentation are not in accordance with the Contract or the Work is not in acceptable condition, Elections Canada will notify the Contractor within 15 calendar days of receipt. The 30-day payment period begins upon receipt of the revised invoice or replacement invoice or the Work being corrected. Failure by Elections Canada to notify the Contractor within 15 calendar days will only result in the date specified in Subsection 5.02.01 to apply for the sole purpose of calculating interest on overdue accounts.

Section 5.03 Withholding of Payment

Where a delay referred to in Article 17 – Excusable Delay has occurred, Elections Canada may, at Elections Canada's discretion, withhold all or a portion of any payment due to the Contractor until a "work-around" plan approved by Elections Canada has been implemented in accordance with Article 17 . Section 5.04 shall not apply to any amount withheld under this Subsection.

Section 5.04 Interest on Overdue Accounts

- 5.04.01 For the purpose of this Section:

"Average Rate" means the simple arithmetic mean of the Bank Rates in effect at 4:00 p.m. Eastern Time each day during the calendar month immediately before the calendar month in which payment is made;

"Bank Rate" means the rate of interest established from time to time by the Bank of Canada as the minimum rate at which the Bank of Canada makes short term advances to members of the Canadian Payments Association;

"date of payment" means the date of the negotiable instrument drawn by the Receiver General for Canada to pay any amount under the Contract; and

an amount becomes “overdue” when it is unpaid on the first day following the day on which it is due and payable according to the Contract.

- 5.04.02 Elections Canada will pay to the Contractor simple interest at the Average Rate plus 3 percent per year on any amount that is overdue, from the date that amount becomes overdue until the day before the date of payment, inclusive. The Contractor is not required to provide notice to Elections Canada for interest to be payable.
- 5.04.03 Elections Canada will pay interest in accordance with this Article only if Elections Canada is responsible for the delay in paying the Contractor. Elections Canada will not pay interest on overdue advance payments.

Article 6 Accounts and Audit

- 6.01.01 The Contractor must keep proper accounts and records of the cost of performing the Work and of all expenditures or commitments made by the Contractor in connection with the Work, including all invoices, receipts and vouchers. The Contractor must retain records, including bills of lading and other evidence of transportation or delivery, for all deliveries made under the Contract.
- 6.01.02 If the Contract includes payment for time spent by the Contractor, its employees, representatives, agents or subcontractors performing the Work, the Contractor must keep a record of the actual time spent each day by each individual performing any part of the Work.
- 6.01.03 Unless Elections Canada has consented in writing to its disposal, the Contractor must retain all the information described in this Article for six years after it receives the final payment under the Contract, or until the settlement of all outstanding claims and disputes, whichever is later. During this time, the Contractor must make this information available for audit, inspection and examination by the representatives of Elections Canada, who may make copies and take extracts. The Contractor must provide all reasonably required facilities for any audit and inspection and must furnish all the information as the representatives of Elections Canada may from time to time require to perform a complete audit of the Contract.
- 6.01.04 The amount claimed under the Contract, calculated in accordance with the basis of payment provision in the Articles of Agreement, is subject to audit both before and after payment is made. If an audit is performed after payment, the Contractor agrees to repay any overpayment immediately on demand by Elections Canada. Elections Canada may hold back, deduct and set off any credits owing and unpaid under this Article from any money that Elections Canada owes to the Contractor at any time (including under other contracts). If Elections Canada does not choose to exercise this right at any given time, Elections Canada does not lose this right.

Article 7 Taxes

Section 7.01 Municipal Taxes

Municipal Taxes do not apply.

Section 7.02 Provincial Taxes Exemption

7.02.01 Except as provided by law, Elections Canada is not required to pay any sales tax payable to the province in which the taxable goods or services are delivered. This exemption has been provided to federal government departments and agencies under the authority of one of the following:

(a) Provincial Sales Tax (PST) Exemption Licence Numbers, for the provinces of:

- i. British Columbia PST-1000-5001;
- ii. Manitoba 390-516-0;

(b) for Saskatchewan, the Yukon Territory, the Northwest Territories and Nunavut, an Exemption certification, which certifies that the goods or services purchased by Elections Canada are not subject to the provincial and territorial sales and consumption taxes because they are purchased by a federal government department or agency with Canada funds for the use of Elections Canada.

7.02.02 Currently, in Alberta, the Yukon Territory, the Northwest Territories and Nunavut, there is no general PST. However, if a PST is introduced in Alberta, the Yukon Territory, the Northwest Territories or Nunavut, PST will be payable unless an exemption certification is included in the purchasing document.

Section 7.03 Harmonized Sales Tax

Elections Canada must pay the HST in the participating provinces of Newfoundland and Labrador, Nova Scotia, New Brunswick, Ontario and Prince Edward Island.

Section 7.04 Quebec Sales Tax

Elections Canada must pay the Quebec Sales Tax in the province of Quebec.

Section 7.05 Provincial Taxes paid by the Contractor

The Contractor is not exempt from paying PST under the above Exemption Licence Numbers or Exemption Certification. The Contractor must pay the PST on taxable goods or services used or consumed in the performance of the Contract (in accordance with applicable provincial legislation), including material incorporated into real property.

Section 7.06 Changes to Taxes and Duties

7.06.01 If there is any change to any tax or duty payable to any level of government in Canada after the bid submission date that affects the costs of the Work to the Contractor, the

Contract Price will be adjusted to reflect the increase or decrease in the cost to the Contractor.

- 7.06.02 However, there will be no adjustment for any change that increases the cost of the Work to the Contractor if public notice of the change was given before bid submission date in sufficient detail to have permitted the Contractor to calculate the effect of the change on its cost. There will be no adjustment if the change takes effect after the date required by the Contract for delivery of the Work.

Section 7.07 Applicable Sales Tax

The estimated amount of applicable sales tax is included in the total estimated cost on page 1 of the Contract. The applicable sales tax is not included in the Contract Price but will be paid by Elections Canada as provided in Section 5.01. The Contractor agrees to remit to the appropriate government agency any amount of applicable sales tax paid or due.

Section 7.08 Tax Withholding of 15 Percent

Pursuant to the *Income Tax Act*, 1985, c. 1 (5th Supp.) and the *Income Tax Regulations*, Elections Canada must withhold 15 percent of the amount to be paid to the Contractor in respect of services provided in Canada if the Contractor is a non-resident unless the Contractor obtains a valid waiver. The amount withheld will be held on account for the Contractor in respect to any tax liability which may be owed to Canada.

Article 8 Transportation

Section 8.01 Transportation Costs

Unless provided otherwise in the Contract, if transportation costs are payable by Elections Canada under the Contract and the Contractor makes the transportation arrangements, shipments must be made by the most direct and economical means consistent with normal shipping practice. The costs must be shown as a separate item on the invoice.

Section 8.02 Transportation Carriers' Liability

In light of the federal government's policy of underwriting its own risks, Elections Canada is precluded to pay for insurance or valuation charges for transportation beyond the point at which ownership of goods passes to it (determined by the FOB point or Incoterms). Where increased carrier liability is available without charge, the Contractor must obtain the increased liability for shipment.

Article 9 Shipment Documentation

For the shipment of goods, the transportation bill of lading must accompany the original invoice, except for "collect" shipments (if and when stipulated), in which event it must accompany the shipment. In addition, a packing slip must accompany each shipment, showing item, quantity, part or reference numbers, description of the goods and contract number, including the PBN. If the goods

have been inspected at the Contractor's plant, the signed inspection voucher must be attached to the packing slip normally enclosed in the packing note envelope.

Article 10 Ownership

- 10.01.01 Unless provided otherwise in the Contract, the Work or any part of the Work belongs to Elections Canada after delivery and acceptance by or on behalf of Elections Canada.
- 10.01.02 However if any payment is made to the Contractor for or on account of any Work, either by way of progress or milestone payments, that Work paid for by Elections Canada belongs to Elections Canada upon such payment being made. This transfer of ownership does not constitute acceptance by Elections Canada of the Work or any part of the Work and does not relieve the Contractor of its obligation to perform the Work in accordance with the Contract.
- 10.01.03 Despite any transfer of ownership, the Contractor is responsible for any loss or damage to the Work or any part of the Work until it is delivered to Elections Canada in accordance with the Contract. Even after delivery, the Contractor remains responsible for any loss or damage to any part of the Work caused by the Contractor or any subcontractor.
- 10.01.04 Upon transfer of ownership to the Work or any part of the Work to Elections Canada, the Contractor must, if requested by Elections Canada, establish to Elections Canada's satisfaction that the title is free and clear of all claims, liens, attachments, charges or encumbrances. The Contractor must execute any conveyances and other instruments necessary to perfect the title that Elections Canada may require.

Article 11 Elections Canada Property

- 11.01.01 All EC Property must be used by the Contractor solely for the purpose of the Contract and remains the property of Elections Canada. The Contractor must maintain adequate accounting records of all EC Property and, whenever feasible, mark it as being the property of Elections Canada.
- 11.01.02 The Contractor must take reasonable and proper care of all EC Property while it is in its possession or subject to its control. The Contractor is responsible for any loss or damage resulting from its failure to do so other than loss or damage caused by ordinary wear and tear.
- 11.01.03 All EC Property, unless it is installed or incorporated in the Work, must be returned to Elections Canada on demand. All scrap and all waste materials, articles or things that are EC Property must, unless provided otherwise in the Contract, remain the property of Elections Canada and must be disposed of only as directed by Elections Canada.
- 11.01.04 At the time of completion of the Contract, and if requested by the Contracting Authority, the Contractor must provide to Elections Canada an inventory of all EC Property relating to the Contract.

Article 12 Warranty

- 12.01.01 Despite inspection and acceptance of the Work by or on behalf of Elections Canada and without restricting any other provision of the Contract or any condition, warranty or provision imposed by law, the Contractor warrants that, for 12 months (or any other period stated in the Contract), the Work will be free from all defects in design, material or workmanship, and will conform to the requirements of the Contract. The warranty period begins on the date of delivery, or if acceptance takes place at a later date, the date of acceptance. With respect to EC Property not supplied by the Contractor, the Contractor's warranty will extend only to its proper incorporation into the Work.
- 12.01.02 In the event of a defect or non-conformance in any part of the Work during the warranty period, the Contractor, at the request of Elections Canada to do so, must as soon as possible repair, replace or otherwise make good at its own option and expense the part of the Work found to be defective or not in conformance with the requirements of the Contract.
- 12.01.03 The Work or any part of the Work found to be defective or non-conforming will be returned to the Contractor's plant for replacement, repair or making good. However, when in the opinion of Elections Canada it is not expedient to remove the Work from its location, the Contractor must carry out any necessary repair or making good of the Work at that location. In such cases, the Contractor will be paid the fair and reasonable Cost (including reasonable travel and living expenses) incurred in so doing, with no allowance for profit, less an amount equal to the Cost of rectifying the defect or non-conformance at the Contractor's plant.
- 12.01.04 Elections Canada must pay the transportation cost associated with returning the Work or any part of the Work to the Contractor's plant pursuant to Subsection 12.01.03. The Contractor must pay the transportation cost associated with forwarding the replacement or returning the Work or part of the Work when rectified to the delivery point specified in the Contract or to another location directed by Elections Canada.
- 12.01.05 The Contractor must remedy all data and reports pertaining to any correction or replacement under this Article, including revisions and updating of all affected data, manuals, publications, software and drawings called for under the Contract, at no cost to Elections Canada.
- 12.01.06 If the Contractor fails to fulfill any obligation described in this Article within a reasonable time of receiving a notice, Elections Canada will have the right to remedy or to have remedied the defective or non-conforming work at the Contractor's expense. If Elections Canada does not wish to correct or replace the defective or non-conforming work, an equitable reduction will be made in the Contract Price.
- 12.01.07 The warranty period is automatically extended by the duration of any period or periods where the Work is unavailable for use or cannot be used because of a defect or non-

conformance during the original warranty period. The warranty applies to any part of the Work repaired, replaced or otherwise made good pursuant to Subsection 12.01.02, for the greater of:

- (a) the warranty period remaining, including the extension; or
- (b) ninety days or such other period as may be specified for that purpose by agreement between the Parties.

Article 13 Liability

The Contractor is liable for any damage caused by the Contractor, its employees, subcontractors, or agents to Elections Canada or any third party. Elections Canada is liable for any damage caused by Elections Canada, its employees or agents to the Contractor or any third party. The Parties agree that no limitation of liability or indemnity provision applies to the Contract unless it is specifically incorporated in full text in the Articles of Agreement or specifically provided for in any supplemental general conditions that form part of the Contract. Damage includes any injury to persons (including injury resulting in death) or loss of or damage to property (including real property) caused as a result of or during the performance of the Contract.

Article 14 Confidentiality

Section 14.01 Confidentiality

- 14.01.01 The Contractor must keep confidential all information provided or made available to the Contractor by or on behalf of Elections Canada in connection with the Work, including any information that is confidential or proprietary to third parties, and all information conceived, developed or produced by the Contractor as part of the Work when copyright or any other intellectual property rights in such information belongs to Elections Canada under the Contract (collectively, the “EC Information”). The Contractor must not disclose any EC Information without the written permission of Elections Canada. The Contractor may disclose to a subcontractor any EC Information necessary to perform the subcontract, as long as the subcontractor agrees to keep such EC Information confidential and that it will be used only to perform the subcontract.
- 14.01.02 The Contractor agrees to use the EC Information only for the purpose of the Contract. The Contractor acknowledges that all EC Information remains the property of Elections Canada or the third party, as the case may be. Unless provided otherwise in the Contract, the Contractor must deliver to Elections Canada all such EC Information, together with every copy, draft, working paper and note that contains such information, upon completion or termination of the Contract or at such earlier time as Elections Canada may require.
- 14.01.03 Subject to the *Access to Information Act*, R.S.C. 1985, c. A-1, and to any right of Elections Canada under the Contract to release or disclose, Elections Canada must not release or disclose outside the Government of Canada any information delivered to Elections Canada under the Contract that is proprietary to the Contractor or a subcontractor.

- 14.01.04 The obligations of the Parties set out in this Article do not apply to any information if the information:
- (a) is publicly available from a source other than the other Party;
 - (b) is or becomes known to a Party from a source other than the other Party, except any source that is known to be under an obligation to the other Party not to disclose the information; or
 - (c) is developed by a Party without use of the information of the other Party.
- 14.01.05 Wherever possible, the Contractor must mark or identify any proprietary information delivered to Elections Canada under the Contract as “Property of (Contractor’s name), permitted uses defined under Elections Canada Contract No. (fill in Contract Number)”. Elections Canada will not be liable for any unauthorized use or disclosure of information that could have been so marked or identified and was not.
- 14.01.06 If the Contract, the Work, or any information referred to in Subsection 14.01.01 is identified as TOP SECRET, SECRET, CONFIDENTIAL, or PROTECTED by Elections Canada, the Contractor must at all times take all measures reasonably necessary for the safeguarding of the material so identified, including those set out in the PWGSC Industrial Security Manual and its supplements and any other instructions issued by Canada.
- 14.01.07 If the Contract, the Work, or any information referred to in Subsection 14.01.01 is identified as TOP SECRET, SECRET, CONFIDENTIAL, or PROTECTED, by Elections Canada, representatives of Elections Canada are entitled to inspect the Contractor’s premises and the premises of a subcontractor at any tier for security purposes at any time during the term of the Contract. The Contractor must comply with, and ensure that any subcontractor complies with, all written instructions issued by Elections Canada dealing with the material so identified, including any requirement that employees of the Contractor or of any subcontractor execute and deliver declarations relating to reliability screenings, security clearances and other procedures.

Section 14.02 An Oath of Secrecy

The Parties hereby agree to sign any document that is necessary for the execution of this Contract, including but not limited to, an oath of secrecy pertaining to information contained in the Register of Electors, lists of electors and/or any record placed under the responsibility and/or owned by Elections Canada.

Article 15 Use and Translation of Written Material

- 15.01.01 Unless provided otherwise in the Contract, copyright in any written material used, produced or delivered under the Contract belongs to its author or rightful owner. Elections Canada has the right to use, copy and disclose, for its purposes, the written material

related to the Work that is delivered to Elections Canada.

- 15.01.02 If the Contract does not require the delivery of any written material in both of Canada's official languages, Elections Canada may translate the written material into the other official language. The Contractor acknowledges that Elections Canada owns the rights on the translation and that Elections Canada is under no obligation to provide the translation to the Contractor. Elections Canada agrees that any translation must include any copyright and any proprietary right notice that was part of the original. Elections Canada acknowledges that the Contractor is not responsible for any technical errors or other problems that may arise as a result of the translation.

Article 16 Intellectual Property Infringement and Royalties

- 16.01.01 The Contractor represents and warrants that, to the best of its knowledge, neither it nor Elections Canada will infringe any third party's intellectual property rights in performing or using the Work, and that Elections Canada will have no obligation to pay royalties of any kind to anyone in connection with the Work.
- 16.01.02 If anyone makes a claim against Elections Canada or the Contractor concerning intellectual property infringement or royalties related to the Work, that Party agrees to notify the other Party in writing immediately. If anyone brings a claim against Elections Canada, Elections Canada may either defend the claim or may request that the Contractor defend Elections Canada against the claim. In either case, the Contractor agrees to participate fully in the defence and any settlement negotiations and to pay all costs, damages and legal costs incurred or payable as a result of the claim, including the amount of any settlement. Both Parties agree not to settle any claim unless the other Party first approves the settlement in writing.
- 16.01.03 The Contractor has no obligation regarding claims that were only made because:
- (a) Elections Canada modified the Work or part of the Work without the Contractor's consent or used the Work or part of the Work without following a requirement of the Contract;
 - (b) Elections Canada used the Work or part of the Work with a product that the Contractor did not supply under the Contract (unless that use is described in the Contract or the manufacturer's specifications);
 - (c) the Contractor used equipment, drawings, specifications or other information supplied to the Contractor by Elections Canada (or by someone authorized by Elections Canada); or
 - (d) the Contractor used a specific item of equipment or software that it obtained because of specific instructions from the Contracting Authority; however, this exception only applies if the Contractor has included the following language in its own contract with the supplier of that equipment or software:

“[Supplier name] acknowledges that the purchased items will be used by the Elections Canada. If a third party claims that equipment or software supplied under this contract infringes any intellectual property right, [supplier name], if requested to do so by either [Contractor name] or Elections Canada, will defend both [Contractor name] and Elections Canada against that claim at its own expense and will pay all costs, damages and legal fees payable as a result of that infringement.”

Obtaining this protection from the supplier is the Contractor’s responsibility and, if the Contractor does not do so, it will be responsible to Elections Canada for the claim.

16.01.04 If anyone claims that, as a result of the Work, the Contractor or Elections Canada is infringing its intellectual property rights, the Contractor must immediately do one of the following:

- (a) take whatever steps are necessary to allow Elections Canada to continue to use the allegedly infringing part of the Work; or
- (b) modify or replace the Work to avoid intellectual property infringement, while ensuring that the Work continues to meet all the requirements of the Contract; or
- (c) take back the Work and refund any part of the Contract Price that Elections Canada has already paid.

If the Contractor determines that none of these alternatives can reasonably be achieved, or if the Contractor fails to take any of these steps within a reasonable amount of time, Elections Canada may choose either to require the Contractor to do (c), or to take whatever steps are necessary to acquire the rights to use the allegedly infringing part(s) of the Work itself, in which case the Contractor must reimburse Elections Canada for all the costs it incurs to do so.

Article 17 Excusable Delay

17.01.01 A delay in the performance by the Contractor of any obligation under the Contract that is caused by an event that

- (a) is beyond the reasonable control of the Contractor,
- (b) could not reasonably have been foreseen,
- (c) could not reasonably have been prevented by means reasonably available to the Contractor, and
- (d) occurred without the fault or neglect of the Contractor, will be considered an “Excusable Delay” if the Contractor advises the Contracting Authority of the

occurrence of the delay or of the likelihood of the delay as soon as the Contractor becomes aware of it.

17.01.02 Within 15 Business Days of an Excusable Delay, the Contractor must:

- (a) provide written notice to the Contracting Authority of all the circumstances relating to such Excusable Delay; and
- (b) provide for approval to the Contracting Authority within 15 Business Days a clear work around plan explaining in detail the steps that the Contractor proposes to take in order to minimize the impact of the event causing the delay.

17.01.03 Any delivery date or other date that is directly affected by an Excusable Delay will be postponed for a reasonable time that will not exceed the duration of the Excusable Delay.

17.01.04 However, if an Excusable Delay has continued for 30 calendar days or more, the Contracting Authority may, by giving notice in writing to the Contractor, terminate the Contract. In such a case, the Parties agree that neither will make any claim against the other for damages, costs, expected profits or any other loss arising out of the termination or the event that contributed to the Excusable Delay. The Contractor agrees to repay immediately to Elections Canada the portion of any advance payment that is unliquidated at the date of the termination.

17.01.05 Unless Elections Canada has caused the delay by failing to meet an obligation under the Contract, Elections Canada will not be responsible for any costs incurred by the Contractor or any of its subcontractors or agents as a result of an Excusable Delay.

17.01.06 If the Contract is terminated under this Article, the Contracting Authority may require the Contractor to deliver to Elections Canada, in the manner and to the extent directed by the Contracting Authority, any completed parts of the Work not delivered and accepted before the termination and anything that the Contractor has acquired or produced specifically to perform the Contract. Elections Canada will pay the Contractor:

- (a) the value, of all completed parts of the Work delivered to and accepted by Elections Canada, based on the Contract Price, including the proportionate part of the Contractor's profit or fee included in the Contract Price; and
- (b) the Cost to the Contractor that Elections Canada considers reasonable in respect of anything else delivered to and accepted by Elections Canada.

The total amount paid by Elections Canada under the Contract to the date of termination and any amounts payable under this Subsection must not exceed the Contract Price.

Article 18 Suspension of the Work

18.01.01 The Contracting Authority may at any time, by written notice, order the Contractor to

suspend or stop the Work or part of the Work under the Contract for a period of up to 180 calendar days. The Contractor must immediately comply with any such order in a way that minimizes the cost of doing so. While such an order is in effect, the Contractor must not remove any part of the Work from any premises without first obtaining the written consent of the Contracting Authority. Within these 180 calendar days, the Contracting Authority must either cancel the order or terminate the Contract, in whole or in part, under Article 19 or Article 20 .

- 18.01.02 The Contracting Authority may, whether in the notice of the order or during the 180 calendar days referred to in Subsection 18.01.01, request that the Contractor provide information regarding the status of the Work or outstanding invoices. The Contractor shall respond within the timeline provided in the request.
- 18.01.03 When an order is made under Subsection 18.01.01, unless the Contracting Authority terminates the Contract by reason of default by the Contractor or the Contractor abandons the Contract, the Contractor will be entitled to be paid its additional costs incurred as a result of the suspension plus a fair and reasonable profit.
- 18.01.04 When an order made under Subsection 18.01.01 is cancelled, the Contractor must resume work in accordance with the Contract as soon as practicable. If the suspension has affected the Contractor's ability to meet any delivery date under the Contract, the date for performing the part of the Work affected by the suspension will be extended for a period equal to the period of suspension plus a period, if any, that in the opinion of the Contracting Authority, following consultation with the Contractor, is necessary for the Contractor to resume the Work. Any equitable adjustments will be made as necessary to any affected conditions of the Contract.

Article 19 Default by the Contractor

- 19.01.01 If the Contractor is in default in carrying out any of its obligations under the Contract, the Contracting Authority may, by giving written notice to the Contractor, terminate for default the Contract or part of the Contract. The termination will take effect immediately or at the expiration of a cure period specified in the notice, if the Contractor has not cured the default to the satisfaction of the Contracting Authority within that cure period.
- 19.01.02 If the Contractor becomes bankrupt or insolvent, makes an assignment for the benefit of creditors, or takes the benefit of any statute relating to bankrupt or insolvent debtors, or if a receiver is appointed under a debt instrument or a receiving order is made against the Contractor, or an order is made or a resolution passed for the winding down of the Contractor, the Contracting Authority may, to the extent permitted by the laws of Canada, by giving written notice to the Contractor, immediately terminate for default the Contract or part of the Contract.
- 19.01.03 If Elections Canada gives notice under Subsection 19.01.01 or 19.01.02, the Contractor will have no claim for further payment except as provided in this Article. The Contractor will be liable to Elections Canada for all losses and damages suffered by Elections Canada because

of the default or occurrence upon which the notice was based, including any increase in the cost incurred by Elections Canada in procuring the Work from another source. The Contractor agrees to repay immediately to Elections Canada the portion of any advance payment that is unliquidated at the date of the termination.

19.01.04 Upon termination of the Contract under this Article, the Contracting Authority may require the Contractor to deliver to Elections Canada, in the manner and to the extent directed by the Contracting Authority, any completed parts of the Work, not delivered and accepted before the termination and anything the Contractor has acquired or produced specifically to perform the Contract. In such a case, subject to the deduction of any claim that Elections Canada may have against the Contractor arising under the Contract or out of the termination, Elections Canada will pay or credit to the Contractor:

- (a) the value, of all completed parts of the Work delivered to and accepted by Elections Canada, based on the Contract Price, including the proportionate part of the Contractor's profit or fee included in the Contract Price; and
- (b) the cost to the Contractor that Elections Canada considers reasonable in respect of anything else delivered to and accepted by Elections Canada.

The total amount paid by Elections Canada under the Contract to the date of the termination and any amount payable under this Subsection must not exceed the Contract Price.

19.01.05 Title to everything for which payment is made to the Contractor will, once payment is made, pass to Elections Canada unless it already belongs to Elections Canada under any other provision of the Contract.

19.01.06 If the Contract is terminated for default under Subsection 19.01.01, but it is later determined that grounds did not exist for a termination for default, the notice will be considered a notice of termination for convenience issued under Subsection 20.01.01.

Article 20 Termination for Convenience

20.01.01 At any time before the completion of the Work, the Contracting Authority may, by giving notice in writing to the Contractor, terminate for convenience the Contract or part of the Contract. Once such a notice of termination for convenience is given, the Contractor must comply with the requirements of the termination notice. If the Contract is terminated in part only, the Contractor must proceed to complete any part of the Work that is not affected by the termination notice. The termination will take effect immediately or, as the case may be, at the time specified in the termination notice.

20.01.02 If a termination notice is given pursuant to Subsection 20.01.01, the Contractor will be entitled to be paid, for costs that have been reasonably and properly incurred to perform the Contract to the extent that the Contractor has not already been paid or reimbursed by Elections Canada. The Contractor will be paid:

- (a) on the basis of the Contract Price, for all completed Work that is inspected and accepted in accordance with the Contract, whether completed before, or after the termination in accordance with the instructions contained in the termination notice;
- (b) the Cost to the Contractor plus a fair and reasonable profit for all work terminated by the termination notice before completion; and
- (c) all costs incidental to the termination of the Work incurred by the Contractor but not including the cost of severance payments or damages to employees whose services are no longer required, except wages that the Contractor is obligated by statute to pay.

Elections Canada may reduce the payment in respect of any part of the Work, if upon inspection, it does not meet the requirements of the Contract.

20.01.03 The total of the amounts, to which the Contractor is entitled to be paid under this Article, together with any amounts paid, due or becoming due to the Contractor must not exceed the Contract Price. The Contractor will have no claim for damages, compensation, loss of profit, allowance arising out of any termination notice given by Elections Canada under this Article except to the extent that this Article expressly provides. The Contractor agrees to repay immediately to Elections Canada the portion of any advance payment that is unliquidated at the date of the termination.

Article 21 Assignment

21.01.01 The Contractor must not assign the Contract without first obtaining the written consent of the Contracting Authority. Any assignment made without that consent is void and will have no effect. The assignment will be effective upon execution of an assignment agreement signed by the Parties and the assignee.

21.01.02 Assignment of the Contract does not relieve the Contractor from any obligation under the Contract and it does not impose any liability upon Elections Canada.

Article 22 Right of Set-Off

Without restricting any right of set-off given by law, Elections Canada may set-off against any amount payable to the Contractor under the Contract, any amount payable to Elections Canada by the Contractor under the Contract or under any other current contract. Elections Canada may, when making a payment pursuant to the Contract, deduct from the amount payable to the Contractor any such amount payable to Elections Canada by the Contractor which, by virtue of the right of set-off, may be retained by Elections Canada.

Article 23 Amendments and Waivers

Section 23.01 Amendment

- 23.01.01 To be effective, any amendment to the Contract must be done in writing by the Contracting Authority and the authorized representative of the Contractor.
- 23.01.02 While the Contractor may discuss any proposed modifications to the Work with other representatives of Elections Canada, Elections Canada will not be responsible for the cost of any modification unless it has been incorporated into the Contract in accordance with Subsection 23.01.01.

Section 23.02 Waiver

- 23.02.01 A waiver will only be valid, binding or affect the rights of the Parties if it is made in writing by, in the case of a waiver by Elections Canada, the Contracting Authority and, in the case of a waiver by the Contractor, the authorized representative of the Contractor.
- 23.02.02 The waiver by a Party of a breach of any condition of the Contract will not be treated or interpreted as a waiver of any subsequent breach and therefore will not prevent it from enforcing that term or condition in the case of a subsequent breach.

Article 24 Codes

Section 24.01 Conflict of Interest and Values and Ethics Codes for the Public Sector

The Contractor acknowledges that individuals who are subject to the provisions of the *Conflict of Interest Act*, 2006, c. 9, s. 2, the Conflict of Interest Code for Members of the House of Commons, the Values and Ethics Code for the Public Sector or all other codes of values and ethics applicable within specific organizations cannot derive any direct benefit resulting from the Contract.

Section 24.02 Code of Conduct for Procurement

The Contractor certifies that it has read the *Code of Conduct for Procurement* (<http://www.tpsgc-pwgsc.gc.ca/app-acq/cndt-cndct/index-eng.html>) and agrees to be bound by its terms.

Article 25 No Bribe or Conflict

Section 25.01 No Bribe

The Contractor declares that no bribe, gift, benefit, or other inducement has been or will be paid, given, promised or offered directly or indirectly to any official or employee of Elections Canada or to a member of the family of such a person, with a view to influencing the entry into the Contract or the administration of the Contract.

Section 25.02 No Conflict of Interest

- 25.02.01 The Contractor must not influence, seek to influence or otherwise take part in a decision of Elections Canada knowing that the decision might further its private interest. The

Contractor must have no financial interest in the business of a third party that causes or would appear to cause a conflict of interest in connection with the performance of its obligations under the Contract. If such a financial interest is acquired during the period of the Contract, the Contractor must immediately declare it to the Contracting Authority.

- 25.02.02 The Contractor warrants that, to the best of its knowledge after making diligent inquiry, no conflict exists. In the event the Contractor becomes aware of any matter that causes or is likely to cause a conflict in relation to the Contractor's performance under the Contract, the Contractor must immediately disclose such matter to the Contracting Authority in writing.
- 25.02.03 If the Contracting Authority is of the opinion that a conflict exists as a result of the Contractor's disclosure or as a result of any other information brought to the Contracting Authority's attention, the Contracting Authority may require the Contractor to take steps to resolve or otherwise deal with the conflict or, at its entire discretion, terminate the Contract for default. Conflict means any matter, circumstance, interest, or activity affecting the Contractor, its personnel or subcontractors, which may or may appear to impair the ability of the Contractor to perform the Work diligently and independently.

Article 26 Contingency Fees

- 26.01.01 The Contractor certifies that it has not, directly or indirectly, paid or agreed to pay and agrees that it will not, directly or indirectly, pay a contingency fee for the solicitation, negotiation or obtaining of the Contract to any person, other than an employee of the Contractor acting in the normal course of the employee's duties.
- 26.01.02 In this Article:
- (a) "contingency fee" means any payment or other compensation that depends or is calculated based on a degree of success in soliciting, negotiating or obtaining the Contract; and
 - (b) "person" includes any individual who is required to file a return with the registrar pursuant to section 5 of the *Lobbying Act*, 1985, c. 44 (4th Supplement).

Article 27 International Sanctions

- 27.01.01 Persons in Canada, and Canadians outside of Canada, are bound by economic sanctions imposed by Canada. As a result, Elections Canada cannot accept delivery of goods or services that originate, either directly or indirectly, from the countries or persons subject to economic sanctions.
- 27.01.02 The Contractor must not supply to Elections Canada any goods or services which are subject to economic sanctions.
- 27.01.03 The Contractor must comply with changes to the regulations imposed during the period of

the Contract. The Contractor must immediately advise Elections Canada if it is unable to perform the Work as a result of the imposition of economic sanctions against a country or person or the addition of a good or service to the list of sanctioned goods or services. If the Parties cannot agree on a work around plan, the Contract will be terminated for the convenience of Elections Canada in accordance with Article 20 .

Article 28 Notice

Any notice under the Contract must be in writing and may be delivered by hand, courier, mail, facsimile or other electronic method that provides a paper record of the text of the notice. It must be sent to the Party for whom it is intended at the address stated in the Contract or to such other address, from time to time designated in writing. Any notice will be effective on the day it is received at that address. Any notice to Elections Canada must be delivered to the Contracting Authority.

Article 29 Survival

All the Parties' obligations of confidentiality, representations and warranties set out in the Contract as well as the provisions, which by the nature of the rights or obligations might reasonably be expected to survive, will survive the expiry or termination of the Contract.

Article 30 Governing Law

Section 30.01 Compliance with Applicable Laws

- 30.01.01 The Contractor must comply with all laws applicable to the performance of the Contract. The Contractor must provide evidence of compliance with such laws to Canada at such times as Elections Canada may reasonably request.
- 30.01.02 The Contractor must obtain and maintain at its own cost all permits, licenses, regulatory approvals and certificates required to perform the Work. If requested by the Contracting Authority, the Contractor must provide a copy of any required permit, license, regulatory approvals or certificate to Elections Canada.

Article 31 Successor and Assigns

The Contract is binding upon and enures to the benefit of Elections Canada and its successors and assigns and the Contractor and its successors and permitted assigns.

Part 6 – Resulting Contract



Procurement and Contracting Services
30 Victoria Street, Gatineau QC K1A 0M6

CONTRACT

The Contractor, as identified below, agrees to sell to the Chief Electoral Officer of Canada, or any person authorized to act on his behalf, in accordance with the terms and conditions set out herein, referred to herein or attached hereto, the goods or services listed herein and on any attached sheets at the prices set out therefore.

Return one signed copy of the Contract forthwith.

Contractor's Name and Address:

[insert LEGAL NAME of Contractor]
[insert Contractor's ADDRESS]

Attention: [insert at contract award]
E-mail: [insert at contract award]

Contract No.: 05005-XX-XXXX	
Title: [insert Contract title]	Effective Date: [insert at contract award]
Term of Contract: [insert at contract award]	Financial Code: [insert at contract award]
Total Estimated Contract Cost (incl. applicable sales tax): [insert at contract award]	Applicable Sales Tax: [insert at contract award]

ENQUIRIES & INVOICES

Office of the Chief Electoral Officer of Canada
30 Victoria Street
Gatineau QC K1A 0M6

Send contract enquiries to:

[insert name at contract award] [insert title] Procurement and Contracting Services	Tel No. [insert at contract award]
	E-mail First.Last@elections.ca

Send invoices to:

[insert name at contract award] [insert title at contract award] [insert sector at contract award]	Tel No. [insert at contract award]
	E-mail First.Last@elections.ca

IN WITNESS WHEREOF, this Contract has been duly executed by the Chief Electoral Officer of Canada by his duly authorized representative and by the Contractor by the hands of its officer duly authorized in that behalf.

<p>[insert LEGAL NAME of Contractor]</p> <p>_____</p> <p>(signature of authorized representative)</p> <p>_____</p> <p>(print name of authorized representative)</p> <p>_____</p> <p>(print title of authorized representative)</p> <p>Date: _____</p>	<p>Chief Electoral Officer</p> <p>_____</p> <p>(signature of authorized representative)</p> <p>[insert name of delegated authority]</p> <p>[insert title of delegated authority] Procurement and Contracting Services [delete if N/A]</p> <p>Date: _____</p>
---	---

ARTICLES OF AGREEMENT

Article 1 Interpretation

Section 1.01 Definitions

1.01.01 In the Contract, unless the context otherwise requires:

“Business Day” means a day other than a Saturday, Sunday or statutory holiday in the province of Quebec;

“Effective Date” means the date stated as the “Date of the Contract” on the first page of the Contract;

“General Conditions” means the general conditions for goods attached hereto as Annex C;

“Initial Term” has the meaning ascribed to in Section 3.01;

“Pricing Table” means the table attached hereto as Annex B;

“SOW” means the Statement of Work attached hereto as Annex A and the appendices referred to therein, if any;

“SPOC” means the Contractor’s single point of contact referred to in Section 5.01 of the Articles of Agreement; and

“Term” means the Initial Term and any additional periods resulting from Elections Canada exercising its irrevocable option to extend the period of the Contract provided for in Section 3.02 of the Articles of Agreement.

1.01.02 The definitions of words and terms in the annexes and appendices apply to capitalized words and terms used in these Articles of Agreement as if those words and terms were defined herein.

ARTICLES OF AGREEMENT

- 1.01.03 The headings used in the Contract are inserted for convenience of reference only and shall not affect their interpretation.
- 1.01.04 In the Contract, words importing the singular number include the plural and vice versa, and words importing the masculine gender include the feminine gender and the neuter.

Section 1.02 Priority of Documents

- 1.02.01 The following annexes are attached to and form an integral part of this Contract. If there is a discrepancy between the wordings of any documents that appear on the list, the wording of the document that first appears on the list has priority over the wording of any document that subsequently appears on the list.
1. these Articles of Agreement;
 2. Annex A – Statement of Work;
 3. Annex B – Pricing Table;
 4. Annex C – General Conditions; and
 5. the Contractor’s proposal, dated [insert date of proposal at contract award].

Article 2 Statement of Work

- 2.01.01 The Contractor must perform the Work in accordance with the SOW.

Article 3 Period of Contract

Section 3.01 Term

- 3.01.01 The Contract period will be from the Effective Date of the Contract (the “Initial Term”) to March 31, 2022.

Section 3.02 Option to Extend

- 3.02.01 The Contractor grants to Elections Canada the irrevocable option to extend the period of the Contract by **one** additional period of **two** years under the same terms and conditions.

ARTICLES OF AGREEMENT

- 3.02.02 Elections Canada may exercise the option at any time during the Term by sending a written notice to the Contractor at least fifteen Business Days before the Contract expiry date.
- 3.02.03 The option to extend the term of the Contract may be exercised only by the Contracting Authority.
- 3.02.04 Upon exercising each option, the amount stated as the “total estimated cost (incl. applicable sales tax)” on the first page of the Contract shall be deemed to be increased to include the amount set out in Subsection 6.02.01.

Article 4 Authorities

Section 4.01 Contracting Authority

- 4.01.01 The Contracting Authority for the Contract is:

[insert at contract award]

Procurement and Contracting Services
Elections Canada
30 Victoria Street
Gatineau QC K1A 0M6
Tel: 819-
E-mail:

- 4.01.02 The Contracting Authority is responsible for the management of the Contract, and any changes to the Contract must be authorized in writing by the Contracting Authority. The Contractor must not perform work in excess of or outside the scope of the Contract based on verbal or written requests or instructions from anybody other than the Contracting Authority.
- 4.01.03 Elections Canada may change the name of the representative designated as Contracting Authority by sending a written notice to the Contractor.

Section 4.02 Technical Authority

- 4.02.01 The Technical Authority for the Contract is:

[insert at contract award]

Elections Canada
Tel: 819-

ARTICLES OF AGREEMENT

E-mail:

- 4.02.02 The Technical Authority named above is the representative of Elections Canada and is responsible for all matters concerning the technical content of the Work under the Contract. Technical matters may be discussed with the Technical Authority; however, the Technical Authority has no authority to authorize changes to the scope of the Work. Changes to the scope of the Work can be made only through a contract amendment issued by the Contract Authority.
- 4.02.03 Elections Canada may change the name of the representative designated as Technical Authority by sending a written notice to the Contractor.

Article 5 Contractor's Representative

Section 5.01 Single Point of Contact

5.01.01 SPOC between the Contractor and Elections Canada is:

[Note to Bidders]

Bidders are to provide in their proposal the name, title, telephone number, facsimile number and e-mail address of its representative which will be included in this Section at contract award.

- 5.01.02 The SPOC must liaise with the Contracting Authority and the Technical Authority and will be the first point of contact in terms of:
 - (a) managing any business issues with the Technical Authority and any Contract issues with the Contracting Authority and, in particular, providing guidance, support and coordination relative to requests;
 - (b) managing the day-to-day operational issues and technical requirements and, in particular, providing support and coordination relative to service; and
 - (c) meeting, as required, with Elections Canada on issues relating to this Contract, including, without limiting the generality of the foregoing, to review the performance of the service, suggest improvements and assist in analyzing statistical data.

Article 6 Basis of Payment

ARTICLES OF AGREEMENT

Section 6.01 Contract Price

6.01.01 The Contractor will be paid for the Work in accordance with the Pricing Table.

Section 6.02 Limitation of Expenditure

6.02.01 Elections Canada's total liability to the Contractor under the Contract must not exceed **#[insert at contract award]**. Customs duties are included and any applicable sales tax is extra.

6.02.02 No increase in the total liability of Elections Canada or in the price of the Work resulting from any design changes, modifications or interpretations of the Work, will be authorized or paid to the Contractor unless these design changes, modifications or interpretations have been approved in writing, by the Contracting Authority before their incorporation into the Work. The Contractor must not perform any work or provide any services that would result in Elections Canada's total liability being exceeded before obtaining the written approval of the Contracting Authority.

6.02.03 With respect to the amount set out in Subsections 6.02.01 the Contractor must notify the Contracting Authority in writing as to the adequacy of such amount:

- (a) when it is 75 percent committed, or
- (b) four months before the Contract expiry date, or
- (c) as soon as the Contractor considers that the contract funds provided are inadequate for the completion of the Work,

whichever comes first.

6.02.04 If the notification is for inadequate contract funds, the Contractor must provide to the Contracting Authority a written estimate for the additional funds required. Provision of such information by the Contractor does not increase Elections Canada's liability.

Section 6.03 Authors Alterations and Other Direct Expenses

6.03.01 The Contractor will be reimbursed for authors alterations and the direct expenses

ARTICLES OF AGREEMENT

reasonably and properly incurred in the performance of the Work. These expenses will be paid at actual cost without mark-up, upon submission of an itemized statement supported by copies of the invoices, receipts and vouchers.

- 6.03.02 All authors alterations and direct expenses must be approved in advance by the Technical Authority. All payments are subject to audit.
- 6.03.03 Subject to Subsection 6.03.01, the maximum cost of any authors alterations or the direct expenses is \$**[insert at contract award]**.

Section 6.04 Applicable Sales Tax

- 6.04.01 The estimated amount of sales tax, if applicable, is included in the total estimated cost specified on page 1 of the Contract. The applicable sales tax is not included in the Contract Price, but will be paid by Elections Canada as provided in Article 8 – Payments. The Contractor agrees to remit to the appropriate government agency any amounts of applicable sales tax paid or due.

Article 7 Liquidated Damages

Section 7.01 Liquidated Damages

- 7.01.01 If the Contractor fails to deliver the goods within the time specified in the Contract, the Contractor agrees to pay to Elections Canada liquidated damages in the amount of **\$250.00** for each calendar day of delay. The total amount of liquidated damages must not exceed 10 percent of the Contract Price.
- 7.01.02 Elections Canada and the Contractor agree that the amount stated above is their best pre-estimate of the loss to Elections Canada in the event of such failure, and that it is not intended to be, nor is it to be interpreted as, a penalty.
- 7.01.03 Elections Canada will have the right to hold back, drawback, deduct or set off from and against the amounts of any monies owing at any time by Elections Canada to the Contractor, any liquidated damages owing and unpaid under this Article.
- 7.01.04 Nothing in this Article must be interpreted as limiting the rights and remedies which Elections Canada may otherwise have under the Contract.

Article 8 Information Reporting

ARTICLES OF AGREEMENT

Section 8.01 Form T1204

- 8.01.01 Pursuant to paragraph 221(1)(d) of the *Income Tax Act*, R.S. 1985, c. 1 (5th Supp.), payments made by departments and agencies, which includes Elections Canada, to contractors under applicable services contracts (including contracts involving a mix of goods and services) must be reported on a T1204 Government Service Contract Payments slip.
- 8.01.02 To enable Elections Canada to comply with this requirement, the Contractor must provide the following information within 15 calendar days following the award of the Contract:
- (a) the legal name of the Contractor, i.e. the legal name associated with its business number or Social Insurance Number (SIN), as well as its address and postal code;
 - (b) the status of the Contractor, i.e. an individual, a sole proprietorship, a corporation, or a partnership;
 - (c) the business number of the Contractor if the Contractor is a corporation or a partnership and the SIN if the Contractor is an individual or a sole proprietorship. In the case of a partnership, if the partnership does not have a business number, the partner who has signed the Contract must provide its SIN; and
 - (d) in the case of a joint venture, the business number of all parties to the joint venture who have a business number or their SIN if they do not have a business number.
- 8.01.03 The information must be sent to the Contracting Authority. If the information includes a SIN, the information should be provided in an envelope marked "PROTECTED".

Article 9 Payment and Invoices

Section 9.01 Payment

- 9.01.01 Elections Canada will pay the Contractor on a monthly basis for that part of the Work performed during the month covered by the invoice in accordance with the Contract if:
- (a) an accurate and complete invoice and any other documents required by the

ARTICLES OF AGREEMENT

Contract have been submitted in accordance with the invoicing instructions provided in the Contract;

- (b) all such documents have been verified by Elections Canada; and
- (c) the Work performed has been accepted by Elections Canada.

Section 9.02 Invoices

9.02.01 The Contractor must submit invoices in accordance with the section entitled "Invoice Submission" of the General Conditions. Invoices cannot be submitted until all Work identified in the invoice is completed.

9.02.02 Each invoice must be supported by:

- (a) a copy of time sheets to support the time claimed if the basis of payment set out in Article 6 is based on hourly rates;
- (b) any other documents or progress reports as specified in the Contract to substantiate the Work performed; and
- (c) a copy of the invoices, receipts and vouchers for all authorized travel and living expenses and other direct expenses.

9.02.03 The original and one copy of each invoice along with one copy of the supporting documentation identified in Subsection 8.02.02 must be forwarded to the address shown on page 1 of the Contract for certification and payment.

Article 10 Option to Acquire Additional Goods or Services

Section 10.01 Option to Acquire Additional Goods or Services

10.01.01 The Contractor grants to Elections Canada the irrevocable option to acquire the goods, services or both described in the SOW under the same terms and conditions and at the prices and/or rates stated in the Contract.

10.01.02 Elections Canada may exercise the option at any time during the Term by sending a written notice to the Contractor at least five Business Days before the Contract expiry date.

ARTICLES OF AGREEMENT

10.01.03 The option may be exercised only by the Contracting Authority and will be evidenced, for administrative purposes, through a contract amendment.

Article 11 Security Requirement

11.01.01 There is no security requirement applicable to this Contract.

Article 12 Insurance

Section 12.01 Insurance

12.01.01 The Contractor is responsible for deciding if insurance coverage is necessary to fulfill its obligation under the Contract and to ensure compliance with any applicable law. Any insurance acquired or maintained by the Contractor is at its own expense and for its own benefit and protection. It does not release the Contractor from or reduce its liability under the Contract.

Article 13 Applicable Laws

Section 13.01 Applicable Laws

[Note to Bidders and Contracting Authority]

If the bidder has identified another province or territory in its proposal, this Section will be modified accordingly at contract award.

13.01.01 The Contract must be interpreted and governed by and construed in accordance with the laws of the province of Ontario and the laws of Canada therein.

Article 14 Certificates

Section 14.01 Certificates

14.01.01 Compliance with the certifications provided by the Contractor in its proposal (the “Certificates”) is a condition of the Contract and subject to verification by Elections Canada during the Term. If the Contractor does not comply with any certification or it is determined that any certification made by the Contractor in the Certificates is untrue, whether made knowingly or unknowingly, Elections Canada has the right,

ARTICLES OF AGREEMENT

pursuant to the default provision of the Contract, to terminate the Contract for default.

Article 15 Foreign Nationals

[Note to Bidders]

Either Option 1 or Option 2 will form part of the resulting contract, depending if the successful bidder is a Canadian contractor or a foreign contractor.

OPTION 1

The Contractor must comply with Canadian immigration requirements applicable to foreign nationals entering Canada to work temporarily in fulfillment of the Contract. If the Contractor wishes to hire a foreign national to work in Canada to fulfill the Contract, the Contractor should immediately contact the nearest Service Canada regional office to enquire about Citizenship and Immigration Canada’s requirements to issue a temporary work permit to a foreign national. The Contractor is responsible for all costs incurred as a result of non-compliance with immigration requirements.

OPTION 2

The Contractor must comply with Canadian immigration legislation applicable to foreign nationals entering Canada to work temporarily in fulfillment of the Contract. If the Contractor wishes to hire a foreign national to work in Canada to fulfill the Contract, the Contractor should immediately contact the nearest Canadian Embassy, Consulate or High Commission in the Contractor’s country to obtain instructions, information on Citizenship and Immigration Canada’s requirements and any required documents. The Contractor is responsible to ensure that foreign nationals have the required information, documents and authorizations before performing any work under the Contract in Canada. The Contractor is responsible for all costs incurred as a result of non-compliance with immigration requirements.

Article 16 Access to Information

Records created by the Contractor under the control of Elections Canada are subject to the

ARTICLES OF AGREEMENT

Access to Information Act. The Contractor acknowledges the responsibilities of Elections Canada under the *Access to Information Act* and must, to the extent possible, assist Elections Canada in discharging these responsibilities. Furthermore, the Contractor acknowledges that section 67.1 of the *Access to Information Act* provides that any person, who destroys, alters, falsifies or conceals a record, or directs anyone to do so, with the intent of obstructing the right of access that is provided by the *Access to Information Act* is guilty of an offence and is liable to imprisonment or a fine, or both.

[Note to Bidders]

If applicable, depending on the legal status of the successful bidder, the following Article will form part of the resulting contract and will be completed at the award of the contract.

Article 17 Joint Venture

Section 17.01 Joint Venture Contractor

17.01.01 The Contractor confirms that the name of the joint venture is _____ and that it is comprised of the following members:

[Insert at contract award]

(a) With respect to the relationship among members of the joint venture Contractor, each member agrees, represents and warrants (as applicable) that:

- i. _____ has been appointed as the “representative member” of the joint venture Contractor and has full authority to act as agent for each member regarding all matters relating to the Contract;
- ii. by giving notice to the representative member, Elections Canada will be considered to have given notice to all members of the joint venture Contractor; and
- iii. all payments made by Elections Canada to the representative member will act as a release by all the members.

17.01.02 All the members agree that Elections Canada may terminate the Contract at its

ARTICLES OF AGREEMENT

discretion if there is a dispute among the members that, in Elections Canada's opinion, affects the performance of the Work in any way.

- 17.01.03 All the members are jointly and severally liable for the performance of the entire Contract.

- 17.01.04 The Contractor acknowledges that any change in the membership of the joint venture (i.e., a change in the number of members or the substitution of another legal entity for an existing member) constitutes an assignment and is subject to the assignment provisions of the General Conditions.

- 17.01.05 The Contractor acknowledges that all security and controlled goods requirements in the Contract, if any, apply to each member of the joint venture Contractor.



EC 50180 – Official Seal
EC 50190 – Short Ballot Box Seal
EC 50200 – Long Ballot Box Seal

Part 7 – Mandatory Technical Evaluation Criteria

Part 7 – Mandatory Technical Evaluation Criteria

Mandatory Technical Evaluation Criteria

The Proposal must clearly demonstrate that the Bidder meets the following Mandatory Technical Evaluation Criteria.

Mandatory Technical Criteria	Description	Bidder must Complete this Section
M1 Compliance with Annex A – Statement of Work	<p>The Bidder acknowledges that they comply with all the requirements of Annex A – Statement of Work.</p> <p>Failure to comply with this requirement will deem your proposal non-responsive and therefore will not be given any further consideration in the evaluation process.</p>	<p>() Yes, I confirm that I will comply with all the requirements of Annex A – Statement of Work.</p> <p>() No, I cannot confirm that I will comply with all the requirements of Annex A – Statement of Work.</p>
M2 Compliance with the Mandatory Delivery Date	<p>The Bidder acknowledges that they comply with the Mandatory Delivery Date as stated in Part 1, Section 1.3.3.</p> <p>Failure to comply with this requirement will deem your proposal non-responsive and therefore will not be given any further consideration in the evaluation process.</p>	<p>() Yes, I confirm that I will comply with the Mandatory Delivery Date.</p> <p>() No, I cannot confirm that I will comply with the Mandatory Delivery Date.</p>



EC 50180 – Official Seal
EC 50190 – Short Ballot Box Seal
EC 50200 – Long Ballot Box Seal

Part 8 – Financial Evaluation Criteria

Part 8 – Financial Evaluation Criteria

In the tables below the Bidder must quote a firm unit price for the completion of all the services as defined in the Annex A – Statement of Work. The firm unit prices quoted by the Bidder must be in Canadian dollars and exclude all Applicable Sales Tax.

Part 8 must be completed in its entirety. Please indicate the price for each item below according to the quantities requested.

The Firm price must include the cost of skids and transportation fee.

Initial Period: from Contract Award to March 31, 2022

Item #	A Item Description	B Unit of measure	C Quantity	D Firm Unit Price	E Firm Extended Price
1.	EC 50180 – Official Seal	Package of 25	150,000 packages	\$ Bidder to insert per package	\$ Bidder to insert
2.	EC 50190 – Short Ballot Box Seal	Package of 10	146,000 packages	\$ Bidder to insert per package	\$ Bidder to insert
3.	EC 50200 – Long Ballot Box Seal	Package of 5	138,000 packages	\$ Bidder to insert per package	\$ Bidder to insert
Total Price (SUM of E1 to E3):					\$ Bidder to insert

Option for Additional Quantities during Initial Period (from Contract Award to March 31, 2022):

Item #	A Item Description	B Unit of measure	C Quantity	D Firm Unit Price
1.	EC 50180 – Official Seal	Package of 25	25,000 to 50,000	\$ Bidder to insert per package
1.	EC 50180 – Official Seal	Package of 25	50,001 to 100,000	\$ Bidder to insert per package
1.	EC 50180 – Official Seal	Package of 25	100,001 to 150,000	\$ Bidder to insert per package

Item #	A Item Description	B Unit of measure	C Quantity	D Firm Unit Price
2.	EC 50190 – Short Ballot Box Seal	Package of 10	25,000 to 50,000	\$Bidder to insert per package
2.	EC 50190 – Short Ballot Box Seal	Package of 10	50,001 to 100,000	\$Bidder to insert per package
2.	EC 50190 – Short Ballot Box Seal	Package of 10	100,001 to 146,000	\$Bidder to insert per package

Item #	A Item Description	B Unit of measure	C Quantity	D Firm Unit Price
3.	EC 50200 – Long Ballot Box Seal	Package of 5	25,000 to 50,000	\$Bidder to insert per package
3.	EC 50200 – Long Ballot Box Seal	Package of 5	50,001 to 100,000	\$Bidder to insert per package
3.	EC 50200 – Long Ballot Box Seal	Package of 5	100,001 to 138,000	\$Bidder to insert per package

Option Period (April 1, 2022 to March 31, 2024):

Item #	A Item Description	B Unit of measure	C Quantity	D Firm Unit Price
1.	EC 50180 – Official Seal	Package of 25	25,000 to 50,000	\$Bidder to insert per package
1.	EC 50180 – Official Seal	Package of 25	50,001 to 100,000	\$Bidder to insert per package
1.	EC 50180 – Official Seal	Package of 25	100,001 to 150,000	\$Bidder to insert per package

Item #	A Item Description	B Unit of measure	C Quantity	D Firm Unit Price
2.	EC 50190 – Short Ballot Box Seal	Package of 10	25,000 to 50,000	\$Bidder to insert per package
2.	EC 50190 – Short Ballot Box Seal	Package of 10	50,001 to 100,000	\$Bidder to insert per package
2.	EC 50190 – Short Ballot Box Seal	Package of 10	100,001 to 150,000	\$Bidder to insert per package

	A	B	C	D
Item #	Item Description	Unit of measure	Quantity	Firm Unit Price
3.	EC 50200 – Long Ballot Box Seal	Package of 5	25,000 to 50,000	\$Bidder to insert per package
3.	EC 50200 – Long Ballot Box Seal	Package of 5	50,001 to 100,000	\$Bidder to insert per package
3.	EC 50200 – Long Ballot Box Seal	Package of 5	100,001 to 150,000	\$Bidder to insert per package

Financial Evaluation:

For Financial Evaluation purposes only, the Total Evaluated Price will be calculated as the sum of the Unit Price of all quantities and all periods (initial period and option period, initial quantities and options for additional quantities).

No Overs / No Unders

Elections Canada will not pay an invoice for items received in excess of the quantity stipulated in Annex A – Statement of Work, nor will it pay the full amount when items are sent in lower quantities than requested. It is the supplier’s responsibility to ensure that items are shipped in the correct quantities.



EC 50180 – Official Seal
EC 50190 – Short Ballot Box Seal
EC 50200 – Long Ballot Box Seal

Part 9 – Certificates

Part 9 – Certificates

1. Independent Proposal

1.1. I, the undersigned, on behalf of _____ **[insert name of Bidder]** (the “Bidder”) in submitting the accompanying proposal (the “proposal”) to Elections Canada for **EC 50180 – Official Seal, EC 50190 – Short Ballot Box Seal & EC 50200 – Long Ballot Box Seal** hereby make the following statements, that I certify to be true and complete in every respect:

- (a) I have read and I understand the contents of this Certificate;
- (b) I understand that the proposal will be disqualified if this Certificate is found not to be true and complete in every respect;
- (c) I am authorized by the Bidder to sign this Certificate, and to submit the proposal, on behalf of the Bidder;
- (d) each person whose signature appears on the proposal has been authorized by the Bidder to determine the terms of, and to sign, the proposal, on behalf of the Bidder;
- (e) for the purpose of this Certificate and the proposal. I understand that the word “competitor” shall include any individual or organization, other than the Bidder, whether or not an Affiliate of the Bidder, who:
 - i. has been requested to submit a proposal in response to the request for proposal;
 - ii. could potentially submit a proposal in response to the request for proposal, based on their qualification, abilities or experience;
- (f) the Bidder disclosed that (check one of the following, as applicable):

- i. the Bidder has arrived at the proposal independently from, and without consultation, communication, agreement or arrangement with, any competitor;

OR

- ii. the Bidder has entered into consultations, communications, agreements or arrangements with one or more competitors regarding this call for proposals, and the Bidder disclosed, in the attached documents (s) complete details thereof, including the names of the competitors and the nature of,

and reasons for, such consultation, communications, agreements or arrangements.

- (g) in particular, without limiting the generality of subparagraphs (f)i. or (f)ii. above, there has been no consultation, communications, agreement or arrangement with any competitor regarding:
- i. prices
 - ii. methods, factors or formulas used to calculate prices;
 - iii. the intention or decisions to submit, or not to submit, a proposal; or
 - iv. the submission of a proposal which does not meet the specifications of the call for proposals;
- except as specifically disclosed pursuant to subparagraph (f)ii. above:
- (h) in addition, there has been no consultation, communications, agreement or arrangement with any competitor regarding the quality, quantity, specifications or delivery particulars of the products or services to which this call for proposals relates, except as specially authorized by the Contracting Authority or as specifically disclosed pursuant to subparagraph (f)ii. above;
- (i) the terms of the proposal have not been, and will not be, knowingly disclosed by the Bidder, directly or indirectly, to any competitor, prior to the date and time of the official proposal opening, or of the awarding of the contract, whichever comes first, unless otherwise required by law or as specially disclosed pursuant to subparagraph (f)ii. above.

2. General

- 2.1. This certification shall be true and correct throughout the term of the Contract with the same force and effect as if continuously made throughout the term of the Contract.
- 2.2. Furthermore, the Bidder acknowledges that Elections Canada shall rely on this certification to award the Contract. Should the Bidder fail to comply with this certification or in the event that verification or inspection by Elections Canada discloses a misrepresentation on the part of the Bidder, Elections Canada shall have the right to treat any contract resulting from this proposal as being in default and to terminate it pursuant to the default provisions of the Contract.

Signature of the Authorized Representative of Bidder

Date

Print Name of Authorized Representative of Bidder:

Print Title of Authorized Representative of Bidder:

