



Fisheries and Oceans  
Canada

Pêches et Océans  
Canada

Canadian  
Coast Guard

Garde côtière  
canadienne



# Statement of Work for the Vessel Life Extension of Canadian Coast Guard 47' Motor Life Boats

Specification Number: F7049-200038-47MLB-001

Revision: 1.2

Requisition Number: F7049-200038

Work Period: November 1, 2021 – April 1, 2029

Canada 

	<b>MLB Specification Index</b>	<b>Page #</b>
<b>H</b>	<b>HULL</b>	
H-1	General Notes	5
H-2	Fire Detection System	35
H-3	Add dampers on the ventilation duct between the survivor compartment and the wheelhouse	41
H-4	Replace Quick Close Fuel Valves and Actuators	44
H-5	Sacrificial Anodes	47
H-6	Sandblast and Paint Hull	50
H-7	Hull Inspection and Inserts	54
H-8	Overhaul Hatches/Doors	57
H-9	Superstructure Inspection and Repairs	60
H-10	Refurbish Windows	63
H-11	Replace Enclosed Bridge Ladder	67
H-12	Refurbish Mast and Buoyancy Tank	69
H-13	Replace Bilge Overboard Piping	73
H-14	Replace Through Hull Connections	76
H-15	Replace Stern Tubes	79
H-16	Refurbish Hand Railings	86
H-17	Insulation in Engine Room and Survivor Space	89
H-18	Hull Docking	92
H-19	Overhaul Seawater Strainers	95
H-20	Replace Survivor Space Deck Panels	98
H-21	Replace Bridge Shock Seats	101
H-22	Aluminum Renewal in Aft Buoyancy Compartments and Forward Deck Lockers	104
H-23	Replace Sea Water Piping	107
H-24	Replace Towing Reel	110
H-25	Replace Window Wiper System	113
H-26	Replace Windscreen on Open Bridge	116
H-27	Improve Bridge Defogging Fan Systems	119
H-28	Exterior Decks	122
H-29	Fuel Tank	125
H-30	Replace Gilman Fenders	128
H-31	Inclining and Lightship Survey	131
<b>M</b>	<b>MECHANICAL</b>	
M-50	Alarm and Monitoring (Remote system)	132
M-51	Replace Manual Fire Pump	136
M-52	Replace Dewatering Pump	139
M-53	Replace Main Engines	141
M-54	Replace Carbon Grounding Brush	147

M-55	Replace Rudders	149
M-56	Replace Propeller Shafts and Coupling Flanges	152
M-57	Inspect Exhaust Components	156
M-58	Replace Steering Components	169
M-59	Move Steering Header Tanks to the Steering Compartment	163
M-60	Replace the HVAC Unit	166
M-61	Replace HVAC Cooling Pumps	169
<b>E</b>	<b>ELECTRICAL</b>	
E-100	General Electronics and Informatics	172
E-101	Replace Battery Chargers	180
E-102	Replace Batteries	183
E-103	Replace Navigation Lights	186
E-104	Replace Electrical Breakers	189
E-105	Replace Shore Power Breaker and Receptacle	192
E-106	Replace/Refurbish Searchlights	195
E-107	Megger Test Wiring	198
E-108	Replace Fuel Gauges and Senders	201
E-109	Exterior Lights	204
E-110	Re-Orient Capsize Control Switches	207
E-111	Multifunction Displays and Network Switches	210
E-112	Open Array Radar	213
E-113	Electronic Charting System Displays	216
E-114	Electronic Charting System PC	219
E-115	Navigation Instrument Displays	222
E-116	National Marine Electronics Association (NMEA) Distribution Network	224
E-117	Satellite Compass	228
E-118	Combined Differential Global Navigation Satellite System and Automatic Identification System (DGNSS/AIS)	231
E-119	Sounder Transducer	235
E-120	Depth Finder/Speed/Temperature Sensor	238
E-121	Autopilot	241
E-122	Integrated Communication System (Wireless)	244
E-123	VHF Radio(s)	247
E-124	MF?HF Radio	251
E-125	Loudhailer/Internal Communication System	254
E-126	VHF DF	257
E-127	General Console Arrangement	262
E-128	General Antenna Arrangement	265
E-129	Weather Station Instrument	269
E-130	Cellular Repeater	272
E-131	Navtex	275

	<b>Annexes and Appendices</b>	
	Annex A - Inclining	278
	Appendix A – Original Supplier List	299
	Appendix B – Alternate Supplier List	301
	Appendix C – Fire System Signage	302
	Appendix D – Parts List	305

	MLB	
Spec Item #: H-1	SPECIFICATION	
GENERAL NOTES		

## 1. GENERAL NOTES

### 1.1. Introduction

1.2. The intent of the Canadian Coast Guard in this scope of work is to extend the working life of the fleet of 47' Motor Life Boats (MLBs). There are 36 MLBs across the country, and there will be 4 contracts awarded, one in each geographical region: Atlantic six (6) vessels, Quebec six (6) vessels, Ontario eleven (11) vessels, and British Columbia thirteen (13) vessels. Work will start in Quebec and Ontario in November 2021, with the intent of two (2) vessels being completed per year until they are all complete in 2024 for Quebec and 2027 for Ontario. Work in BC will start start in December 2021, with two (2) vessels being completed per year until completion in 2028. Work in Atlantic will start start in November 2022, with two (2) vessels being completed per year until completion in 2025.

### 1.3. Vessel Particulars

#### 1.3.1. Details

Name:	MLBs
Type:	SAR Lifeboat
Class:	
Year Built:	1998 to 2012
Principle Dimensions:	
Length:	14.6M
Breadth, molded:	4.3
Loaded Draft:	1.4
Tonnage, displacement	33.8
Propulsion	Twin geared drive diesel

#### 1.3.2. Equipment

Equipment	Make	Model	Serial#
Propulsion Diesel	Caterpillar	(2) x 3196	
Steering System	HyproMarine		
Ship Service Generators	(2) x Shaft Generator (2) x Alternator		

1.3.2.1. The nature of these vessels require strict weight control. The Contractor in selecting materials and equipment must select materials of the same weight and size as equipment being replaced. Equipment removed must be weighed and its location noted. The replacement equipment must also be weighed and relocated in the same position as the equipment being replaced. A record must be maintained

of the weights removed the weight of the replacement equipment and the difference in weight for each component. Refer to the Weight Management Plan details in Annex A.

- 1.3.2.2. The contractor is advised that in certain specification items the contractor is required to supply a particular make and model of equipment or equivalent. A complete list of these parts can be found in Appendix D. When the term “or equivalent” is used the contractor may substitute a different make and model of equipment provided the equivalent equipment is demonstrated to meet all the form, fit, function and service life of the specified piece of equipment. The contractor prior to purchasing the equipment must submit a copy of the specifications for the proposed equipment and the required interfacing into the existing vessel’s systems to the TA for review. The TA will advise of any discrepancy from the requirements included in the specifications. The review and comments provided by the TA will not absolve the contractor from meeting the required performance specified in the specification.
- 1.3.2.3. The contractor must include in its proposal all costs of fitting the equivalent equipment. This would include but not be limited to; engineering, changes to mounts, changes to piping, changes to controls and electrical requirements.

## **2. SERVICES**

### **2.1. Vessel Services**

- 2.1.1. The vessel while docked must be contained in a weather tight enclosure. Enclosure must be maintained at a minimum of 10 degrees Celsius and allow access for the conduct of work and access by workers. Shelter must provide full protection to allow for welding and painting on the vessel during inclement weather.
- 2.1.2. The vessel must be supplied with 110 Volt, 100 Amp, single phase AC power for the duration of the docking at the Contractor’s expense.
- 2.1.3. Contractor to ensure that all spaces, compartments, and areas where work has been carried out, or Shipyard staff has used for transit routes, are left in “as clean a condition as found” when the vessel commenced refit. All rags, debris, and associated garbage generated by the shipyard staff while on board must be removed to the garbage container(s) each day. The costs associated with the removal of dirt, debris, and garbage must be included in the quote.
- 2.1.4. Berthing and mooring facilities must be provided upon arrival of vessel. The Contractor is responsible for supplying and installing additional mooring lines if required while vessel is berthed at Contractors facility. During refit, while not dry-docked; vessel must be berthed at Contractor's wharf. There must be sufficient water beneath the vessel that it does not touch bottom at any time.

- 2.1.5. Shipyard is responsible for all movements of the vessel during the refit period; including arrangements and costs of linehandlers, tugs, pilots, initial tying up, any movement of the vessel during refit and letting go of lines from Contractor's wharf on vessel departure from yard upon completion of refit.
- 2.1.6. Contractor must supply and install one (1) gangway, while the vessel is removed from water. The gangway must be safe, well lit and structurally suitable for the passage of shipyard personnel and CCG personnel. Contractor must maintain the gangway in a safe condition throughout the duration of the refit while the vessel is out of the water. Initial installation and later removal of gangway must be included in quote, as well as maintenance and upkeep while vessel is in Contractor's yard. Any movement of gangway required by Contractor will be at their cost.

## **2.2 Workspace Services**

- 2.2.1. The Contractor must provide an office workspace for the duration of the contract adjacent to the dock. The office must be equipped with a minimum of one desk and two chairs for the exclusive use of the CGTA and PSPC. Each desk must be provided with a wired Ethernet LAN connection with direct internet access. The Contractor must supply a broadband high speed internet service to this connection.
- 2.2.2. The Contractor must supply clean toilet and wash-up facilities for the use of the CGTA and PSPC within the same building or contiguous to the same building for the duration of the work period.
- 2.2.3. Sufficient parking for DFO/CCG and PSPC representatives must be provided conveniently close to the berthed or docked vessel. Contractor must provide one (1) clearly designated for "DFO/CCG and PSPC use only" parking spaces for the duration of the docking period.
- 2.2.4. Contractor must supply a listing of shipyard contacts, fire, police and emergency telephone numbers to CGTA when vessel arrives at Contractor's facilities. Contractor must ensure that the CGTA is notified of any "on call personnel" and their contacts during non-working hours and days.

## **3. CORRESPONDENCE & REPORTS**

### **3.1. Inspection and Testing**

- 3.1.1. The Contractor must demonstrate that the completed work and equipment is in compliance with the performance requirements of this Specification. The Contractor must develop test and trial procedures, and conduct all tests and trials required by this Specification and as required by the regulatory bodies in order that all appropriate certificates for the vessel are issued. The Contractor must obtain all necessary certificates for the vessel to ensure that the vessel is fully certified and seaworthy for a vessel of its class prior to the completion of the contract.

- 3.1.2. The Contractor must provide the CGTA with a complete list of disturbed services and systems that require functional and operational tests prior to the completion of each specification requirement. The Contractor must develop specific test procedures to test the operational and functional condition of each of the disturbed services and/or ship's systems. The Contractor must submit the list of disturbed services and ship's systems and the associated specific test procedures for review to TA twenty (20) working days prior to the start of these system tests.
- 3.1.3. The Contractor must prepare a trials schedule showing dates, sequence, procedures, and duration of each trial or set of trials. This agenda, including the proposed trial record sheets for all trials, must be submitted for review and comment to the CGTA and the CGIA (Coast Guard Inspection Authority) twenty (20) working days prior to the start of any tests and trials.
- 3.1.4. The Contractor must coordinate the trials agenda with ABS to ensure attendance where necessary. The Contractor must ensure a manufacturer's FSR or written authorization from the manufacturer must be available prior to initial start-up of newly installed or modified equipment. All trials must be witnessed by the CGTA and where necessary, by ABS, FSR's and any sub-Contractors. All tests must be completed on individual components of a system and all defects repaired to meet the manufacturer's equipment specifications. Once defects are corrected, the test and trial must be repeated in the presence of the TA and where necessary ABS.
- 3.1.5. Contractor must note; when calling in for inspection services, it is required that the Surveyors be called to view more than one (1) item at a time. Contractor is to account for this when planning their work schedule or bar chart, which must be submitted to CGTA and their representatives. Contractor must note that when the Survey Authorities are called in to perform the required inspections on work they have completed and inspections fail, the next inspection fee for the work being re-inspected must be at the Contractor's expense. CGTA will pay the first inspection fee.
- 3.1.6. Shop testing, dock and sea trials procedures must be to the standards required by ABS. Where ABS have no requirements for shop test procedures, the Contractor must adhere to the S.N.A.M.E. (Society of Naval Architects and Marine Engineers) guidelines. The minimum standard for all electrical dock and sea trials must be in accordance with ABS, TP127E and IEEE Std 45-2002. All electronic equipment static tests must be completed prior to sea trials with only the operational tests to be carried out at sea.
- 3.1.7. Hydrostatic testing of piping and components forming part of any system must be completed prior to any operational testing of the system. The Contractor must have on hand signed and witnessed test sheets showing the results of hydrostatic tests prior to the



operational tests of the system. As a minimum the IA must be notified when any components are being hydrostatically tested.

- 3.1.8. All sub-assemblies and piping systems fabricated or assembled by the Contractor must be hydrostatically tested to 1.5 times the system's working pressure and proven tight to the satisfaction of the IA prior to installation on the vessel.
- 3.1.9. Machinery and equipment must not be subjected to pressures higher than their maximum allowable operating pressure during system pressure tests. Valves at the components may be closed, or the connection blanked off to protect such components from excessive pressure. Instruments, pressure switches and other components that could be damaged by excessive pressure of system tests must be removed or otherwise protected during the tests.
- 3.1.10. For tests, calibrated pressure gauges must be installed at the connections provided in the gauge piping for this purpose. During tests, readings of installed gauges must be checked with the calibrated test gauges. Installed gauges must be adjusted where necessary to register pressure accurately. The Contractor must provide calibration certificates for all instrumentation used for the testing of systems to the IA and the TA.
- 3.1.11. All components necessary for the safe operation of the system must be checked and adjusted during the operating tests to demonstrate compliance with the requirements specified and approved for the system. Operating tests must demonstrate that the piping design and installation meet the service demands.
- 3.1.12. Components, such as spring hangers must be adjusted where necessary and flexible piping connections slip joints, expansion joints and noise isolation pipe fittings must be checked for proper operation while the system in which they are installed is being operated.
- 3.1.13. All systems must have a visual inspection and must be leak-free during the specified tests.
- 3.1.14. All system pressure and operating tests must be completed before the system trials.
- 3.1.15. In addition to dock trials and commissioning tests of individual ship systems specified within this Specification the Contractor must perform a full set of sea trials in accordance with the "Guide for Sea Trials" as published by S.N.A.M.E. The Contractor must develop all sea trial procedures and data sheets. The sea trial procedures with attached data sheets must be submitted to the IA and the TA for review and approval twenty (20) working days prior to the start of the Sea Trials. This sea trial does not replace any trials required by the DPTS (Diesel Propulsion Train Shipset) Contractor.

3.1.16. All test, trials and inspection generated data must be documented by the Contractor and assembled as one complete data package and submitted to the TA at the end of the refit.

### **3.2. Schedule**

3.2.1. At the Pre Refit Meeting, the successful Contractor must provide a Production Bar Chart or Schedule showing commencement and completion dates for each item in this specification. This document must highlight any critical dates and be capable of showing the effects of late completion date of the work package. Contractor must provide updated Production Schedules to the CGTA, and PSPC Inspector whenever the schedule is revised.

3.2.2. The Contractor must provide weekly Progress Reports describing the status of the project time line, cost and performance as an introduction. Time, cost and performance must then be addressed in detail. The report must identify significant risks to the program and the actions taken to resolve these risks. The risk analysis must identify any impact upon delivery and actions taken to recover any slippage that may affect the contract delivery date. The report, in electronic format, must be delivered to the CGTA. The progress report must include sub-Contractor and major component supplier activity.

3.2.3. Unless otherwise agreed upon, all type written correspondence, reports, certificates and drawings presented to the CGTA must computer generated and be provided in English. Additional copies may be submitted in French.

All reports must be completed in a timely manner (with in a 24 hour period for small reports to a maximum of a week for detailed reports; timeline as identified by the CGTA) and provided to the CGTA immediately following their completion, and must continue as required throughout each specification item.

## **4. TECHNICAL DATA PACKAGE**

### **4.1. Regulations**

4.1.1. The latest edition, at the time of contract signing, of all Acts, Regulations, Standards, Publications, and Procedures listed below must be applied as reference. Only mandatory amendments that occur during the contract period, must take precedence as the reference to apply. The Contractor must ensure all work completed in the specification is done to all pertinent Federal and Territorial Regulations and Standards. CCG procedures must be used as a guide if no other regulation takes precedence.

<b>FSM Procedures</b>	<b>Title</b>	<b>Included Yes/No</b>
CCG/5737	Fleet Safety Manual (Latest Edition)	Yes
Ship Specific	Vessel Specific - Asbestos Risk Assessment Report and Management Plan	No
<b>Publications</b>	<b>Title</b>	<b>Included Yes/No</b>
	Guidelines for Canadian Drinking Water Quality <a href="https://www.canada.ca/en/health-canada/services/environmental-workplace-health/reports-publications/water-quality/guidelines-canadian-drinking-water-quality-summary-table.html">https://www.canada.ca/en/health-canada/services/environmental-workplace-health/reports-publications/water-quality/guidelines-canadian-drinking-water-quality-summary-table.html</a>	No
CCG/70-000-000-EU-JA-001	CCG Specification for the Installation of Shipboard Electronic Equipment	Yes
EPS Report 1/RA/2	Environmental Code of Practice for the Elimination of Fluorocarbon Emissions from Refrigeration and Air Conditioning Systems - Environment Canada <a href="https://www.canada.ca/en/environment-climate-change/services/canadian-environmental-protection-act-registry/publications/code-practice-elimination-fluorocarbon-emissions.html">https://www.canada.ca/en/environment-climate-change/services/canadian-environmental-protection-act-registry/publications/code-practice-elimination-fluorocarbon-emissions.html</a>	No
IEC 60533	Electrical and Electronic installations in ships – Electromagnetic Compatibility <a href="https://standards.ieee.org/">https://standards.ieee.org/</a>	No
IEC 60945	Maritime Navigation and Radio communication equipment and systems – methods of testing and required test results. <a href="https://standards.ieee.org/">https://standards.ieee.org/</a>	No
IEEE45	Institute of Electrical and Electronics Engineers, Recommended Practice for Electrical Installations on Shipboard <a href="https://standards.ieee.org/">https://standards.ieee.org/</a>	No
NFPA 10	Standard for portable fire extinguishers <a href="https://www.nfpa.org/">https://www.nfpa.org/</a>	No
NFPA 306 2014	Standard for the Control of Gas Hazards on Vessels <a href="https://www.nfpa.org/">https://www.nfpa.org/</a>	No
TC SSB 04/2019	Hydrostatic testing of pressure containers under the Vessel Fire Safety Regulations	No
TC SSB 06/1989	Grounding Safety in Dry-dock	No
TP 11469	Guide to Structural Fire Protection	No
TP 127E	Ships Electrical Standards	No
TP 14231	Marine Occupational Health and Safety Program	No
TP 14612	Procedures for Approval of Life-saving Appliances and Fire Safety Systems, Equipment and Products	No
TP 3668	Standards for Navigating Appliances and Equipment	No
TP 4414 E	Guidelines Respecting Helicopter Facilities on Ships – under review	No
<b>Standards</b>	<b>Title</b>	<b>Included Yes/No</b>

ASHRAE	American Society of Heating, Refrigerating, and Air Conditioning Engineers <a href="https://www.ashrae.org/">https://www.ashrae.org/</a>	No
ASME Y14.100	American Society of Mechanical Engineers Y14.100 - 2017 Engineering Drawing Practices - Nov. 14, 2017 <a href="https://www.ashrae.org/">https://www.ashrae.org/</a>	No
ASTM B88M-83	Standard Specification for Seamless Copper Water Tube <a href="https://www.astm.org/">https://www.astm.org/</a>	No
ASTM E165-18	Standard Practice for Liquid Penetrant Testing for General Industry <a href="https://www.astm.org/">https://www.astm.org/</a>	No
CAN/CGSB 48.9712	National Non-Destructive Testing Certification Body of Natural Resources Canada <a href="https://www.nrcan.gc.ca/science-data/national-non-destructive-testing-certification-body/22056">https://www.nrcan.gc.ca/science-data/national-non-destructive-testing-certification-body/22056</a>	No
Spec-caras-ca-014-000-NU-TD-001-ENG	CCG Specification for Electronic Data Deliverables	Yes
CCG/18-080-000-SG-003	CCG Paints and Coatings Standards	Yes
CCG/30-000-000-ES-TE-001	CCG Colour Coding Standard for Piping Systems	Yes
CCG/6016	CCG Fleet – Federal Identity Program Guide	Yes
CCG/CT-014-000-ES-TD-001G	CCG CAD using AutoCAD	Yes
CCG/CT-043-EQ-EG-001-E	CCG Welding Specification	Yes
CSA W178.1	Certification of Welding Inspection Organizations	No
CSA W178.2	Certification of Welding Inspectors Endorsement: Ships and Marine Structures; and Buildings and Industrial Structures	No
CSA W47.1	Certification of Companies for Fusion Welding of Steel Structures Division 2 Certification	No
CSA W47.2	Certification of Companies for Fusion Welding of Aluminum	No
CSA W48	Filler Metals and Allied Materials for Metal Arc Welding	No
CSA W59	Welded Steel Construction – Metal Arc Welding	No
CSA W59.2	Welded Aluminum Construction	No
CSA Z462	Workplace Electrical Safety	No
IACS Rec No 20	Non-destructive testing of ship hull steel welds <a href="http://www.iacs.org.uk/publications/">http://www.iacs.org.uk/publications/</a>	No
IACS Rec No 47	Shipbuilding and Repair Quality Standard <a href="http://www.iacs.org.uk/publications/">http://www.iacs.org.uk/publications/</a>	No
ISO 10816-1:1995	Mechanical vibration -- Evaluation of machine vibration by measurements on non-rotating parts -- Part 1: General guidelines <a href="https://www.iso.org/standards.html">https://www.iso.org/standards.html</a>	No
ISO 11126 Parts 1-8	Preparation of steel substrates before application of paints and related products — Specifications for non-metallic blast-cleaning abrasives <a href="https://www.iso.org/standards.html">https://www.iso.org/standards.html</a>	No

ISO Standard 4406/2017	Hydraulic Fluid Power – Fluids – Method for coding the level of contamination by solid particles <a href="https://www.iso.org/standards.html">https://www.iso.org/standards.html</a>	No
ISO 484/2-2015	Part 1, Propellers of Diameter 0.8m to 2.50 m <a href="https://www.iso.org/standards.html">https://www.iso.org/standards.html</a>	No
ISO 8501	Preparation of steel substrates before application of paints and related products <a href="https://www.iso.org/standards.html">https://www.iso.org/standards.html</a>	No
ISO 8502-6	Preparation of steel substrates before application of paints and related products — Tests for the assessment of surface cleanliness — Part 6: Extraction of soluble contaminants for analysis — The Bresle method <a href="https://www.iso.org/standards.html">https://www.iso.org/standards.html</a>	No
ISO 9712:2005	International Standards for NDT <a href="https://www.iso.org/standards.html">https://www.iso.org/standards.html</a>	No
NACE No. 2 /SSPC-SP10	Near-White Metal Blast Cleaning <a href="https://www.nace.org/home">https://www.nace.org/home</a>	No
NACE_WJ-3/SSPC-SP_WJ-3	Waterjet Cleaning of Metals—Thorough Cleaning (WJ-3) <a href="https://www.nace.org/home">https://www.nace.org/home</a>	No
NEMA AB 4 – 2017	Guidelines for Inspection and Preventive Maintenance of Molded-Case Circuit Breakers Used in Commercial and Industrial Applications <a href="https://www.nema.org/pages/default.aspx">https://www.nema.org/pages/default.aspx</a>	No
NSF/ANSI/CAN 61	Drinking Water System Components <a href="https://www.techstreet.com/nsf">https://www.techstreet.com/nsf</a>	No
S.M.A.C.N.A.	Sheet Metal and Air Conditioning Contractors' National Association <a href="https://www.smacna.org/">https://www.smacna.org/</a>	No
SSPC	The Society for Protective Coatings <a href="https://www.sspc.org/">https://www.sspc.org/</a>	No
UL 1066	Standard for Low-Voltage AC and DC Power Circuit Breakers Used in Enclosures <a href="https://standardscatalog.ul.com/standards/en/standard_1066_4">https://standardscatalog.ul.com/standards/en/standard_1066_4</a>	No
Regulations	Title	Included Yes/No
Canada Labour Code	Canada Labour Code (R.S.C., 1985, c. L-2)	No
CSA, 2001	Canada Shipping Act	No
MOHS SOR 2010-120	Maritime Occupational Health and Safety <a href="https://laws-lois.justice.gc.ca/eng/regulations/SOR-2010-120/index.html">https://laws-lois.justice.gc.ca/eng/regulations/SOR-2010-120/index.html</a>	No
Workers' Safety & Compensation Commission work-safe regulation of the province or territory where the work is performed	<a href="http://www.ccohs.ca/oshanswers/information/wcb_canada.html">http://www.ccohs.ca/oshanswers/information/wcb_canada.html</a>	No

#### 4.2. Guidance Drawings

4.2.1. See specific sections for relevant guidance drawings.

### 4.3. Tanks

- 4.3.1. Listed are the tanks found on board, their location by frame number and capacity (where available). These must be used as reference only and must not supersede any specification.
- 4.3.2. Fuel Tank – 1450 L at 90% capacity. Located on centerline, between Frame 5 and Frame 8, below survivors space deck.
- 4.3.3. Bilge Holding Tank – Between Frame 11 and Frame 12, located on centerline of vessel

### 4.4. Abbreviations

ACM: Asbestos Containing Material	MCA: Matériaux contenant de l'amiante
CFM: Contractor Furnished Material and/or Equipment	MFE: Matériel Fourni par l'Entrepreneur
CLC: Canada Labour Code	CCT: Code canadien du travail
CSA: Canadian Standards Association	CSA: Association canadienne de normalisation – ACNOR
CWB: Canadian Welding Bureau	BCS: Bureau canadien du soudage
DFO/CCG: Department of Fisheries and Oceans, Canadian Coast Guard	MPO/ GCC: Ministère des Pêches et des Océans, Garde côtière canadienne
FSR: Manufacturer's Field Service Representative	RSF: Représentant de service du fabricant
FSM: Fleet Safety Manual	MSSF: Manuel de Sûreté et de Sécurité de la Flotte
GSM: Government Supplied Material and/or Equipment	MFG: Matériel fourni par le Gouvernement
HC: Health Canada	SC: Santé Canada
IA – Inspection Authority	AI – Autorité Inspectant
IEEE: The Institute of Electrical & Electronic Engineers Inc.	IEEE: Institute of Electrical and Electronic Engineers
MSDS: Material Safety Data Sheet	FS: Fiche Signalétique
NDT: Non Destructive Testing	END: Essais Non Destructifs
OEM: Original Equipment Manufacturer	FEO: Fabricant d'Équipement d'Origine
OHS: Occupational Health and Safety	SST: Santé et sécurité au travail
PSPC – Public Service and Procurement Canada	SPAC – Service public et approvisionnement Canada
PSPC: Public Service and Procurement Canada	SPAC: Services Publics et Approvisionnement Canada
RO: Recognized Organization as defined by Canada Shipping Act.	OR: Organismes Reconnus par la Loi sur la marine marchande du Canada
SSMS: Safety and Security Management System	SGSS: Système de gestion de la sécurité et de la sûreté

TBS: Treasury Board of Canada Secretariat	SCT: Secrétariat du Conseil du Trésor du Canada
TA: Technical Authority -CCG Superintendent, Marine Engineering	AT: Autorité technique propriétaire (GCC)
TCMS: Transport Canada Marine Safety	SMTC: Sécurité Maritime de Transports Canada
TI: Technical Inspector – CCG delegated.	AI: Autorité de l'Inspection Inspecteur technique (GCC)
TSR – Technical Service Representative	RST – Représentant du Service Technique
VCS: Vessel Condition Survey	DCC: Demange de Changement de Configuration
VLE: Vessel Life Extension	PVN: Prolongement de vie d'un navire
WCB: Workers' Compensation Board	CNESST: Commission des normes, de l'équité, de la santé et de la sécurité du travail (CNESST)
WHMIS Workplace Hazardous Materials Information System	SIMDUT: Système d'information sur les matières dangereuses utilisées au travail

## 5. Conditions and Definitions

5.1. The following conditions and definitions are applicable to all work contained in the Specifications and are intended to outline the quality of workmanship and practice that is the minimum acceptable level:

- a) the word "install" means that the Contractor must connect mechanically and electrically. The Contractor must provide the labour and material to complete the installation;
- b) The word "reinstall" means a piece of equipment that the Contractor has affected repairs on and must be returned/installed in its original location and be mechanically and electrically connected. The Contractor must provide the labour and material to complete the reinstallation;
- c) The word "remove" means that the Contractor must provide all labour and material to remove the unit, equipment, material, or system in its entirety. Part of the removal process is to blank openings, restore insulation and paint;
- d) the word "relocate" means that the Contractor must provide all labour and material to remove the unit, piece of equipment, or system and to install the same unit, piece of equipment, or system in the new location;
- e) The term "or equivalent" means a substitute which has equal characteristics i.e. (size, materiel type, life, weight, input, and output) as approved by the TA. A comparison of the general specifications must be provided to the TA for the equipment specified and the "or equivalent" (i.e. old compared to the new);
- f) the term "overhaul" as applied to any mechanical equipment, structure or system comprises: disassembly into component parts; cleaning examination of parts for defects; gauging of parts for wear; reporting of parts worn beyond specification

- limits or otherwise defective and reassembly followed by specification adjustments; tests; and functional trials;
- g) the word "disconnect" means the Contractor must mechanically and electrically disconnect the piece of equipment of all piping, wiring, seating and other attachments permitting the removal of the unit as a whole;
  - h) the word "disassemble" means that the Contractor must provide all labour to take apart, piece by piece, the equipment, machinery or system must be examined or repaired;
  - i) the word "reassemble" means that the Contractor must provide all labour and material to put together, piece by piece, the equipment, machinery or system on completion of examination or repair;
  - j) the words "Additional Work Procedures" means the procedures as defined in solicitation and contract and includes any additional work required on a system, sub-system or equipment which the original specification did not specify;
  - k) the word "calibrate" means the adjustment of readings and measurements to a known OEM standard;
  - l) The word "check" means that the Contractor must provide labour to find faults by sighting, feeling or listening. The checking of any equipment does not involve the disturbance or removal of parts, components or sub-assemblies;
  - m) the word "examine" means that the Contractor must provide labour for the process of systematically examining, checking and testing equipment, records or administrative procedures to detect actual or potential defects or errors;
  - n) the word "test" means that the Contractor must provide labour, equipment, tools or other means to conduct the operation of a unit in relation to a stated standard or procedure;
  - o) The words "set-to-work" means the tuning, alignment and adjustment of equipment/systems required subsequent to satisfactory installation. Inspection to make the equipment/systems ready for technical acceptance trials;
  - p) the word "trials" is an element of QA that means an action(s) by which the Contractor proves by a visual or instrumental presentation that the equipment or system satisfies the requirements of the specified trials agenda; and
  - q) the term "functional test" means operation of a piece of equipment in all its normal operating modes and throughout its operating range to establish that it must perform its designed function within normal operating parameters as indicated in the manufacturer's documentation.

## **6. Miscellaneous Provisions**

### **6.1. Occupational Health and Safety**

- 6.1.1. The Contractor and all sub-Contractors must follow Occupational Health and Safety (OHS) procedures in accordance with applicable federal and provincial OHS



regulations ensuring that Contractor activities are carried out in a safe manner and do not endanger the safety of any personnel. Additionally the Contractor and Contractor's employees must not have access to the vessel's washrooms and crew mess facilities. The Contractor must provide the necessary amenities as required.

6.1.2. Where "Safety Management System" is referenced in this document, it is referring to the Contractor's Safety Management System, which must be in effect while in the Contractor's Care and Custody and must be in accordance with the applicable OHS regulations and procedures.

- a) The Contractor must, for all work on Canadian Coast Guard Vessels, meet or exceed the Safety Management System defined in the Fleet Safety Manual (FSM) unless a Contractor proposed comprehensive Safety Management System is presented and accepted by the TA.

6.1.3. When the Contractor works on the vessel, while in the Care and Custody of the Canadian Coast Guard, the Safety Management System of CCG must be followed:

- a) Contractor and all its representatives must attend an orientation session on vessel safety before beginning any work to familiarize the Contractor's employees with the dangers specific to the vessel and with its permit systems for work protocols as well as with the procedures for safety, risk prevention, hazard response and pre-work safety assessments. The Contractor must have access to an uncontrolled copy of the Fleet Safety Manual.
- b) The Contractor must comply with the Fleet Safety Manual, DFO/5737, as well as with the instructions for working on board the vessel. Additionally, the Contractor must comply to the relevant requirements of the Canada Labour Code during performance of the following types of work:
  - i. Work at heights;
  - ii. Entry into enclosed spaces;
  - iii. Degassing before entering into confined spaces and for hot work;
  - iv. Lockout and Tagout;
  - v. Pre-work safety assessments.
- d) For the purpose of the Lockout and identification procedure, the Contractor must provide the padlocks and locking devices for the Contractor's employees in addition to those provided by the Chief Engineer for the vessel's crew.
- e) The Contractor must adhere to local facilities shore based safety instructions and safety procedures.

6.1.4. The Contractor must identify a specified person that is responsible for the safety management of the work site. The Safety Manager must ensure that daily safety rounds are carried out and that safety issues are identified and safety precautions are maintained.

- 6.1.5. Areas that pose a hazard as a result of the specification work must be secured and clearly identified by the Contractor with signage to advise and protect all personnel from the hazard in accordance with applicable regulations.

## **6.2. Lead Paint and Paint Coatings**

- 6.2.1. The Contractor must not use lead based paints.
- 6.2.2. CCG ships have been painted with lead based paints in the past and as a result some of the Contractor's processes such as grinding, welding and burning may release this lead from the coatings. The Contractor must ensure that coatings in the affected work areas are tested for lead content and that the work is performed in accordance with applicable Federal and Provincial regulations.
- 6.2.3. The Contractor must provide Health Canada (HC) product approval for underwater hull surface paints controlled by HC and the Pest Management Regulatory Agency.
- 6.2.4. The Contractor must demonstrate that lead paint work procedures are in place and have been approved by the workplace Occupational Health and Safety Committee and that these safe work procedures are in compliance with provincial regulations.
- 6.2.5. The Contractor must demonstrate that supervisors and workers performing any lead abatement procedures have been trained and that records are available for inspection, proving that this training is current and has taken place. Training must at a minimum conform to section 6 of the Environmental Action Committee of Ontario (EACO) Lead Guideline for Construction, Renovation, Maintenance or Repair, latest edition.
- 6.2.6. The Contractor must demonstrate that their Quality Assurance department has the capacity to monitor on-site work progress, is capable of performing air quality monitoring on an ongoing basis as required by the Occupational Health and Safety Regulations and is able to assess the affected areas post abatement process.
- 6.2.7. The Contractor must provide the TA with all records from lead abatement processes and the final disposal certificates for all materials generated from the abatement process.

## **6.3. Touch-up / Disturbed Paint**

- 6.3.1. The Contractor, at a minimum, must repair coating systems disturbed as a result of the specified work. Coating systems must be in accordance with the coating system of the vessel, and be applied in accordance with the paint manufacturer's recommended procedures.

## **6.4. Coating Inspections**

An independent third party Surveyor, certified by the authoritative body known as the National Association of Corrosion Engineers (NACE) has been independently contracted to assist the CGTA with overseeing the preparation and application of coating to all areas identified in this specification. Surveyor will ensure that the manufacturer's specifications are met with respect to the preparation and application

of the coating and curing of the coating. This requirement is further clarified to state that the Surveyor will be a NACE level 2 Surveyor (minimum). The Surveyor is not an employee of the painting subcontractor and must be given access to the work areas described within this specification in order to perform inspections. Contractor will be provided with the NACE Surveyor contact information at the start of refit. Contractor to schedule the NACE Surveyor and inform CGTA prior to start of any coating applications so that they can be present prior to, during and after the completion of the application for inspection purposes.

## **6.5. Asbestos Containing Materials (ACM)**

- 6.5.1. The Contractor must NOT use any asbestos containing material.
- 6.5.2. The Contractor will be supplied the most recent Asbestos Risk Assessment Report and Asbestos Management Plan by CCG.
- 6.5.3. Handling of any asbestos containing materials must be performed by trained personnel and/or a company certified in the removal of asbestos in accordance with Federal, Provincial/Territorial and Municipal regulations.
- 6.5.4. The Contractor must provide the TA with disposal certificates for all asbestos containing material removed from the vessel indicating that the disposal was in accordance with Federal, Provincial and Municipal regulations in effect.
- 6.5.5. The Contractor must provide an "Observation Report (OR)" with reference to any concerns or intentions in regards to asbestos containing materials not already specified. The Contractor must identify any materials that are suspected to contain asbestos prior to any work being completed. Any approved work resulting from the OR must follow the Additional Work Procedures via PSPC 1379 action.

## **6.6. Confined Spaces**

- 6.6.1. Entry into any confined space onboard the vessel during the contract period must be conducted in accordance with the safety management system as determined in the Pre-Work Meeting. In addition to those requirements, the Contractor must also conduct the following:
  - a) Have a qualified person issues a "Gas Free Certificate" for spaces that will be entered and post the certificate outside the entrance to the space. Certificates must specify, "Safe for persons" or "safe for hot work" as appropriate.
  - b) Provide copies of all certificates generated to the TA in accordance with the Documentation section of the General Notes.

## **6.7. Hot Work**

- 6.7.1. All hot work conducted during the contract must be in accordance with the Safety Management System. In addition to the requirements of the Safety Management System the Contractor must as a minimum also:

- a) Certify confined spaces affected by hot work as “safe for hot work” in accordance with the Confined Spaces section of the General Notes.
- b) Remove all portable combustible materials from the vicinity, to a safe distance not less than two meters away;
- c) Supply and install protective material to prevent the spread of sparks, protect electrical cables and other services;
- d) Supply and post fire sentries in each space and in the adjacent space where welding, grinding, or burning is being carried out on bulkheads, deck heads or decks;
- e) Supply and provide appropriate fire extinguisher(s) to the fire sentries and ensure each sentry is trained in the extinguisher’s use. The fire sentry must maintain a watch in his designated area for a minimum of thirty (30) minutes after any hot work has been completed. The Contractor must record the sentry attendance time on all hot work permits indicating when hot work stopped, and time sentry left post;
- f) Provide a copy of the site generated hot work permits to the TA in accordance with the Documentation section of the General Notes; Named in accordance with the specification item generating the required work.

## **6.8. Work Aloft**

- 6.8.1. Any work aloft onboard the vessel during the maintenance/refit period must be conducted in accordance with the Safety Management System. Notices must be placed to prevent operation of Radars while personnel are working aloft on the mast or on the wheelhouse top.

## **6.9. Electrical Equipment**

- 6.9.1. When working on electrically operated equipment, the Contractor must lock-out equipment in accordance with the Safety Management System, and as a minimum conduct the following:
  - a) Isolate the main power source and any alternative power source to the equipment;
  - b) Install Electrical lock-outs and place electrical caution tags on the main power source and any alternate power sources for the switches/disconnects supplying the equipment under maintenance;
  - c) Verify at the terminals to ensure power is not present.
  - d) Ensure the lock-outs and electrical caution tags remain in place until completion of all work.
- 6.9.2. The TA must be notified of all such ongoing work.
- 6.9.3. All electrical installations and repairs must be done in accordance with the latest revisions of TP127E - Electrical Standards of Transport Canada Marine Safety and of

IEEE Standard 45 – Recommended Practice for Electrical Installation on Ships.  
Standard TP127E takes precedence over the IEEE standard.

#### **6.10. Workplace Hazardous Information Materials System (WHIMS)**

- 6.10.1. The Contractor must provide the TA with Safety Data Sheets (SDS) for all Contractor and Sub-Contractor supplied WHIMS controlled products. SDS sheets must be the formats requested in the Documentation section of the General Notes.
- 6.10.2. All SDS sheets must be maintained in accordance with OHS procedures.
- 6.10.3. The TA will provide the Contractor with access to SDS sheets for all controlled products on the ship for all specified work items on request.

#### **6.11. Smoking in the Work Space**

- 6.11.1. The Contractor must ensure compliance with the Non-Smokers' Health Act. The Contractor must ensure that there is absolutely no smoking onboard the vessel by their employees, including the employees of any Sub-Contractor.

#### **6.12. Contractor Furnished Materials (CFM) and Tools**

- 6.12.1. The Contractor must ensure replacement material such as jointing, packing, insulation, small hardware, oils, lubricants, cleaning solvents, preservatives, paints, coatings etc. are in accordance with the equipment manufacturer's drawings, manuals and/or instructions.
- 6.12.2. Where no particular item is specified or where substitution must be made, the Contractor must submit an Observation Report to the TA indicating the substitution or item not specified. The Contractor must provide information about materials used, certificate of grade and quality of various materials to the TA prior to use.
- 6.12.3. The Contractor must supply all but not limited to the following: All labour, materials, parts, tools, consumables, equipment, machinery, storage, shelters, staging, rigging, scaffolding, enclosures, power and heating, required to perform the specified work unless otherwise stated.
- 6.12.4. The Contractor must deliver and store all new CFM equipment at their facility. The CFM must be stored in a secure, environmentally controlled space in accordance with the equipment storage section of this specification.

#### **6.13. Government Supplied Materials (GSM) and Tools**

- 6.13.1. Where tools are supplied by Canada, they must be returned by the Contractor in the same condition as when they were borrowed. Borrowed tools must be inventoried and signed for by the Contractor on receipt and return to the TA.
- 6.13.2. Any GSM not specifically stated in the Technical Specification must be received by the Contractor and stored in accordance with the Equipment Storage section of this specification. These activities must be covered by the Procedures for Design Change or Additional Work via PSPC 1379 action.

**6.14. Storage**

- 6.14.1. Equipment (i.e. covers, cowling and other items that may need must be removed and stored) must be stored in accordance with the equipment manufacturer's or equipment vendor's specific storage instructions. The Contractor must make these instructions available to the TA.
- 6.14.2. All equipment and items must be stored in such a manner so as must be easily accessible for inspection. No items must be stored directly on floors.
- 6.14.3. All materials and equipment removed from the vessel by the Contractor, unless specifically identified within the project requirements for disposal as scrap, must remain the property of Canada.
- 6.14.4. All such equipment and materials must be held and retained in good condition by the Contractor pending instructions from the IA or TA.
- 6.14.5. Materials removed from the vessel must be classified as follows;
  - Cat A – Return to CCG – Either for disposal through CADC or long term storage
  - Cat B – Return to ship
  - Cat C – Must be disposed of by the contractor
- 6.14.6. The Contractor must obtain agreement with the IA or TA for the disposal of materials and equipment that will have no market value after removal from the vessel. Cost estimation must be supplied and environmental regulations may apply on some products.

**6.15. Regulatory Inspections and/or Class Surveys**

- 6.15.1. The Contractor must contact, coordinate, schedule, and be completely prepared for all regulatory inspections and surveys by the applicable authority: i.e. RO, HC, Environment Canada or others as indicated by individual specifications.
- 6.15.2. For the purposes of this contract all regulatory inspection must be conducted by RO, Canada will be paying all RO's fees, including all RO inspections. RO retains the authority to inspect the vessel at any time. Inspection expenses occurred by RO or the RO will be handled outside of this contract. Any work arising within this contract due to RO inspection results or additional work not covered by this statement of work will be handled via PSPC 1379 action.
- 6.15.3. Documentation generated by the above inspections and/or surveys indicating that the inspections and/or surveys were conducted (i.e. original signed and dated certificates) must be provided to the TA in accordance with the "Documentation" Section of these General Notes.
- 6.15.4. The Contractor must not substitute inspection by the TA for the required regulatory inspections.

- 6.15.5. The Contractor must provide timely advance notification (minimum of 5 working days) of scheduled regulatory inspections to the TA so they may witness the inspection. Additional time must be allowed due to changing COVID 19 travel restrictions.
- 6.15.6. The Contractor must arrange for all visits and inspections associated with RO's, HC, Environment Canada, or any other inspection required by the specification unless otherwise indicated. All costs and fees associated with these visits and inspections must be billed directly to Canada.

#### **6.16. Contractor Inspections**

- 6.16.1. The Contractor must afford the TA the opportunity to conduct an inspection with the Contractor on the condition and location of items must be removed prior to either carrying out the specified work or gaining access to a location to carry out the work.
- 6.16.2. The Contractor must take sufficient before pictures of conditions prior to removing any items. These photographs must be in accordance with the Documentation section of the General Notes, named according to the specification (H-5g Sacrificial Anodes, M-52 Replace Dewatering Pump, etc.) that resulted in removing those items.
- 6.16.3. Prior to the close out of any item under this specification, the Contractor must afford the TA the opportunity to verify the work has been completed in accordance with the specification. At that time the Contractor must have available all photographs, documents, reports, and trials in relation to the item being closed out as completed.

#### **6.17. Recording of Work in Progress**

- 6.17.1. The TA may record any work in progress using various means including, but not limited to, photography and video, digital or film.

#### **6.18. Access for Maintenance, Installation, and Removal.**

- 6.18.1. The layout of newly installed machinery and equipment must be designed and constructed to permit ready access for routine maintenance, operational checks and operational inspections without disturbance of other machinery, equipment or structure.
- 6.18.2. The Contractor must determine best routes for installing and removing equipment. All lifting points currently fitted on the ship must be treated as uncertified, and must be certified before use by the Contractor.
- 6.18.3. Temporary lifting points installed by the Contractor must be removed prior to transfer of custody with welds ground flush, and paint coatings applied in accordance with the vessel's paint specification.
- 6.18.4. Manufacturer's recommended removal clearances must be allowed for.
- 6.18.5. After equipment installation and/or removal the Contractor must make good all equipment relocations, blemishes, and penetrations and must return the affected areas of the ship to the As-Delivered working condition.

**6.19. Assembly of Components**

- 6.19.1. The Contractor must ensure that during installation of specified equipment, that parts and assembled equipment are cleaned of smudges, spatter or excess solder, weld metal and metal chips or any other foreign material which might detract from the intended operation, function, or appearance of the equipment. (This would include any particles that could loosen or become dislodged during the normal expected life of the equipment). All corrosive material must be removed. This cleaning must take place before the parts are assembled into the equipment.
- 6.19.2. Covers, cowlings and components damaged by the Contractor must be replaced with a new CFM cover, cowling, or component.
- 6.19.3. Where torque specifications are not provided by the manufacturer, the applicable SAE, ANSI, or BS1083 nut and bolt standard torques must be used.

**6.20. Protection of Equipment**

- 6.20.1. The Contractor must ensure that surfaces and components of equipment installed on the vessel are protected against damage, soiling, and contamination as a result of contracted work.
- 6.20.2. All electrical and electronic equipment and components must be protected during the contract against physical damage, internal damage, and by the effects of adverse temperatures or other environmental conditions.
- 6.20.3. The Contractor must protect equipment that could be damaged as a result of movement of materials and equipment nearby. The Contractor must also protect equipment from nearby sources of contamination, including but not limited to, burning, welding, media (sand) blasting, grinding and painting.
- 6.20.4. Any damage to surfaces, equipment, furnishings or decor incurred prior to acceptance must be returned to As-Delivered condition by the Contractor.
- 6.20.5. All openings in machinery and/or systems prior to connections being made must be kept covered by fitted secure solid inserts or covers at all times.
- 6.20.6. The Contractor must obtain and follow instructions from its OEM Sub-Contractors for any special protection required for their equipment during the project work. Such instructions must be made available to the TA.
- 6.20.7. Physical protection, including but not limited to, plastic sheets, fireproof covers, heavy weight material covers, wood plugs, wood encasements and heaters must be used as required.
- 6.20.8. The Contractor must protect the vessel from the possibility of vermin infestation (insect/mammal/bird). If an infestation does occur during the contract period, the Contractor must bear all costs to ensure the vessel is made vermin free before the vessel's departure and contract completion.

**6.21. Halocarbon Containing Systems**



- 6.21.1. All work conducted on Halocarbon containing systems, must be in accordance with the Federal Halocarbon Regulations, 2003 (SOR/2003-289). These regulations are available on the internet here: <http://laws-lois.justice.gc.ca/eng/regulations/SOR-2003-289/page-1.html>

**6.22. Welding Structures - Contractor Requirements**

6.22.1. Certification Requirements for Steel Structures

All welding contractors must be certified by the Canadian Welding Bureau (CWB) to Canadian Standards Association (CSA) Standard W47.1 -2019, Division 1 or 2. The contractor must meet all of the requirements of Annex M – Qualification of Welding Personnel and Procedures for Marine Applications.

6.22.2. Certification Requirements for Stainless Steel Structures

All welding contractors must be certified by the Canadian Welding Bureau (CWB) to CSA Standard W47.1 -2019, Division 1 or 2. The contractor must meet all of the requirements of Annex K – Qualification of Welding Personnel and Procedures for Stainless Steel Materials.

6.22.3. Certification Requirements for Aluminum Structures

All welding contractors must be certified by the CWB to CSA Standard W47.2-11 (R2015), Division 1 or 2.

6.22.4. Scope of Certification

The scope of certification filed with the CWB as required by CSA Standards W47.1-2019 and W47.2-11 (R2015) must include all welding work performed under the requirements of the CCG vessel specifications and statements of work.

Pipe used as hollow structural section material such as pillars, masts, supports, handrails, etc., must not be excluded from any company's scope of certification

6.22.5. Validation Certificates

Company welding certification validation certificates are required for each contractor and subcontractor facility where welding work will take place. Scope of certification indicated on the validation certificates must include all welding work performed under the requirements of the CCG vessel specifications and statements of work.

6.22.6. Welding Procedures

All welding procedure specifications and/or welding procedure data sheets must be qualified by procedure qualification testing and reviewed and approved by the CWB prior to use.

Welding procedures must be tested to the requirements of Annex M of CSA Standard W47.1-2019 for all steel welding work, Annex K of CSA Standard W47.1-2019 for

all stainless steel welding work and to the requirements of CSA Standard W47.2-11 (R2015) for all aluminum welding work.

6.22.7. Welding Personnel

All welding personnel must be approved by the CWB prior to their commencing any welding work.

Welders must be tested to the requirements of Annex M of CSA Standard W47.1-2019 for all steel welding work, Annex K of CSA Standard W47.1-2019 for all stainless steel welding work and to the requirements of CSA Standard W47.2-11 (R2015) for all aluminum welding work.

6.22.8. Performance and Qualification Testing

All welder performance and welding procedure qualification testing must be fully witnessed and documented by the CWB.

6.22.9. Limitations Prior to Commencing Welding Work

All Contractors must submit their welding personnel qualification records and approved welding procedures to the CGTA prior to commencing any welding work.

All welding procedures, including welding procedure specifications and welding procedure data sheets, must include an indication of acceptance by the Contractor's Welding Engineer (by signature, seal or other appropriate means) and a stamp of acceptance by the CWB.

6.22.10. Governing Standards for Welding

For structural steels  $\geq 3$  mm in thickness, welding must meet the requirements of CSA W47.1-2019 – Annex M, CSA W59-2018, and the CCG Welding Specification CT-0043-EQ-EG-1-E.

For structural stainless steels  $\geq 3$  mm in thickness, welding must meet the requirements of CSA W47.1-2019 – Annex K, AWS D1.6-2017 and the CCG Welding Specification CT-0043-EQ-EG-1-E.

For structural aluminum  $\geq 3$  mm in thickness, welding must meet the requirements of CSA W47.2-11 (R2015), CSA W59.2-2018 and the CCG Welding Specification CT-0043-EQ-EG-1-E.

**6.22.11. Welding Structures – Weld Design**

6.22.12. Weld design must be to the Rules of a Classification Society that is an approved Recognized Organization by Transport Canada Marine Safety and Security and/or as given on the supplied design drawings or welding schedules.

Unless otherwise approved by the CGTA, the following conditions must be met:

- all groove welds in butt joints of plate and pipe must be complete joint penetration; and,
- all corner joints must be complete joint penetration groove welds combined with single continuous fillet welds.

A weld design schedule must be submitted to the CGTA in drawing form for review prior to commencing any welding work.

Welds must not be made without an approved weld design requirement for each joint to be welded.

#### **6.22.13. Welding Structures – Symbols for Welding**

- 6.22.14. Design drawings must include weld requirement symbols and construction drawings must include welding symbols following the requirements of CSA Standards W59-2018 and W59.2-2018. For fillet welds, the drawings and welding schedules must indicate if the weld dimension shown in the symbol is throat size or leg length.

#### **6.22.15. Welding Structures - Surface Weld Inspection**

- 6.22.16. All completed welds must be examined visually by a third party welding inspector certified by the CWB to CSA Standard W178.2-2018, Level 2 or 3. The individual must have code endorsements for the standards of compliance being used for acceptance (CSA W47.1/W59, CSA W47.1/AWS D1.6 and/or W47.2/W59.2). Safe access must be given to the satisfaction of the CGTA. Lighting, viewing angle and viewing distance for close up examination must meet the requirements of ASME Section V.

Steel butt welds in thick plate ( $\geq 19$  mm) that have been visually examined must undergo examination by magnetic particle testing following the requirements of CSA W59-2018. Third party personnel performing magnetic particle examination must be qualified by the Certifying Agency of NRCAN to the requirements of CGSB 48.9712, Level 2 or 3. Procedures and techniques must meet the requirements of CSA W59-2018. The entire weld length (100%) must be examined.

Aluminum butt welds in thin plate ( $< 5$  mm) that have been visually examined must undergo examination by penetrant testing following the requirements of CSA W59.2-2018. Third party personnel performing penetrant examination must be qualified by the Certifying Agency of NRCAN to the requirements of CGSB 48.9712, Level 2 or 3. Procedures and techniques must meet the requirements of CSA W59.2-2018. The entire weld length (100%) must be examined.

#### **6.22.17. Welding Structures - Volumetric Weld Inspection**

- 6.22.18. All volumetric weld inspection examinations must be performed by a third party inspection organization certified by the CWB for the inspection methods to be used

in accordance with CSA Standard W178.1-2018. Volumetric weld inspection examinations must be performed in accordance with all of the requirements of the CCG Welding Specification CT-0043-EQ-EG-1-E.

The non-destructive examination methods used for volumetric weld inspection and the extent of the examinations must be as required in the vessel specifications and/or statements of work.

**6.22.19. Welding Structures - Vacuum Box Leak Testing**

6.22.20. Vacuum box leak testing of welds does not exclude the contractor from performing the third party non-destructive examination requirements specified herein and within the CCG Welding Specification CT-0043-EQ-EG-1-E.

**7. Documentation**

**7.1. Text Documentation**

- 7.1.1. All text deliverables must be accompanied by a PDF file that must contain the complete document. The Contractor must check the quality to verify that the content reflects the same content/formatting as the Master Document file. In the case of changes, a second PDF file that contains only the changed sheets must be supplied.
- 7.1.2. The Contractor must provide all text documentation in text searchable Adobe PDF format (lossless software conversion of the original and lossless scanning conversion of the original is both acceptable).

**7.2. Data Book**

- 7.2.1. The Contractor must provide all documentation generated as a result of specified deliverables, in both digital and paper formats. There must be 2 hard copies of each document, in two separate binders, as part of the Contractor's QA program. An electronic PDF copy of all documentation must also be provided to the TA in accordance with the formats described in this specification section.
- 7.2.2. All copies of documents generated as a result of specified deliverables must be referred to as the "Data Book".
- a) The Data Book must be indexed by the individual specification titles.
  - b) Documents must be clearly linked to the specification they were derived from.
  - c) Documents which identify 'parts purchased – model/part numbers' by the Contractor must be included in the Data Book for ease of future spare parts ordering, as well as the Supplier's contact information.
  - d) Each specification item must be signed off as being completed, with all corrective actions completed, before the Data Book will be considered complete.
- 7.2.3. The Contractor must provide to the TA all the files generated as part of the Data Book prior to the contract completion. The files must be in digital format (Flash Drive / Memory Stick). The contractor must ensure with the TA, that the digital

format is readable and accessible to Canada. Each specification item must have its own folder named according to the specification item. For example “G1.0 General Notes”.

- 7.2.4. Any documentation, media, and reports that are the result of Additional Work must be included as part of the Data Book.
- a) Additional Work must be linked to the specification it was derived from by the title and specification designator.
  - b) All tests, measurements, calibrations and readings recorded, must be signed by the person taking the measurements, dated and scanned into electronic format as part of the Data Book.
  - c) The Contractor’s quality assurance documents must be included into the Data Book.

### **7.3. File Naming**

- 7.3.1. File naming must be in the following format: Specification#.# – Date (yyyy-mm-dd) – File Name Describing Information. For Example: “G1.0 – 2016-12-01 – Details of file naming.pdf”.

### **7.4. E-mails**

- 7.4.1. Any files sent to the CA/TA by e-mail must be named as per the “File Naming” section of this specification. All files that are e-mailed must have in the subject name: “Contract# - DATA BOOK – Date – Specification #”. For Example: F1782- 0 – DATA BOOK – 2015-11-30 – G1.0 General Notes. Files sent by e-mail must also be included in the “Data Book”. File attachments should be limited in size to ensure deliverability. It is the Contractors responsibility to ensure the CA/TA has properly received all documentation.

### **7.5. File Formatting**

- 7.5.1. All documentation, reports, test results, certificates, or data obtained by the Contractor in paper form must be scanned into unprotected, searchable, Adobe PDF formatted files and named according to the File Naming section of this specification.
- 7.5.2. All reports, test results, certificates, or raw data obtained by the Contractor in electronic format must be converted to unprotected Adobe PDF formatted files and named according to the “File Naming” section of this specification. Both the original and the converted copy must be provided as part of the Data Book.

### **7.6. Photographs**

- 7.6.1. All photographs obtained by the Contractor as requested in the specification must be provided in .JPG formatted files at a resolution of at least 640 x 480 and named according to the “File Naming” section of this specification.

### **7.7. Measurements, Calibrations, and Readings.**

- 7.7.1. All measurements, calibrations and readings recorded, must be signed by the person taking the measurements, dated and scanned into electronic format as part of the Data Book.
- 7.7.2. Unless otherwise specified the Contractor must record dimensions to a precision of three significant digits in imperial along with the metric equivalent.
- 7.7.3. The Contractor must provide to the TA current and valid calibration certificates, and control values for all instrumentation used in the Test and Trials Plan, showing that the instruments have been calibrated in accordance with the manufacturer's instructions. These copies must be provided as part of the Data Book, under any specification where measurements are required.

## **7.8. Test/Inspection Records and Certificates**

- 7.8.1. Test and/or Inspection Records and Certificates are identified as a deliverable in the individual specification item requesting them.
- 7.8.2. Test and/or Inspection Records and Certificates, must be included as a separate section in the Data book and indexed/arranged in numeric order by specification number.
- 7.8.3. The Contractor is responsible for maintaining a complete and accurate record of all tests and trials conducted on the vessel and on each piece of equipment. Prior to the commencement of a trial, all relevant documentation and associated test sheets, including shop test data, must be complete and attached to the trials agenda.
- 7.8.4. All tests and trials data must be legible both in hard copy and electronic format. If necessary, handwritten records may require transcription into electronic format in order must be acceptable. The original must be signed by the regulatory body, the TA, the Contractor and where necessary, by the Sub-Contractors and/or FSR's who witnessed the tests. All the data must be submitted to the TA in accordance with the Documentation section of these General Notes.
- 7.8.5. The Contractor must, in addition, provide originals of each certificate document to the TA in an envelope marked with the vessel's name and the works "Original Certificates".

## **8. Drawings**

- 8.1.1. This section, must be referred to as the Drawings section of the General Notes, is intended must be used as reference for the minimum standards when specified deliverables must be drawings.
- 8.1.2. The Contractor must have on staff or through a Sub-Contractor a person qualified and experienced in the use of AutoCAD who will create or modify drawings that result from the work.
- 8.1.3. The Contractor must comply with the Canadian Coast Guard National CAD Standards titled "Computer Aided Design (CAD) using AUTOCAD" provided.

- 8.1.4. Each drawing Flash Drive / Memory Stick must be clearly labeled with the Contract Number, file names and drawing numbers. If a complete listing exceeds the label size, a “readme.txt” file in ASCII format must be provided with each Flash Drive / Memory Stick. A hard copy of the Readme file must accompany each disk. Disks must be labeled As-Fitted drawings for those drawings that have been approved and finalized.
- 8.1.5. Final As-Fitted prints/plots must not contain markings or corrections by hand (i.e. marker, pen, pencil, etc.). Drawings containing mark-ups must be revised and re-printed/plotted.
- 8.1.6. The Contractor must prepare all the working drawings necessary for the project requirements and modernization work.
- 8.1.7. The Contractor must furnish all drawings required by OEM sub-Contractors, trades and other consultants.
- 8.1.8. Schematic drawings of systems must include all pertinent system information, including sizes, dimensions, labeling, equipment locations, and all information relating to system fittings.
- 8.1.9. The Contractor must have in place a complete system of documenting and controlling all drawing revisions affected by the work of this project. Drawing numbering system and titles must match the original drawings for clarity and include a revision number with date.
- 8.1.10. The Contractor must use ASME Y14.100 for guidance for drawing deliverables.
- 8.1.11. The Contractor must ensure that if changes to an existing drawing are required, those changes and the revised drawing must be approved by the RO.

## **8.2. Guidance Drawings**

- 8.2.1. All technical guidance drawings are issued to the Contractor for guidance purposes only. It is the responsibility of the Contractor to develop working drawings and to ensure that all such drawings receive applicable regulatory approval. The Contractor must note that not all technical guidance drawings supplied are As-Fitted drawings. It is the responsibility of the Contractor to physically verify all affected items.
- 8.2.2. All departures from the provided guidance drawings and project specifications must be clearly indicated by the Contractor and written approval obtained from the TA before carrying out such alterations or departures.
- 8.2.3. Specification deviations must be documented using an Observation Report.

## **8.3. As Fitted Drawings**

- 8.3.1. The As-Fitted Drawings are identified as a deliverable in the specification item requesting them.
- 8.3.2. Upon completion of specified work, the Contractor must transfer the mark-ups from any working drawings where installation changes were made to drawings affected by the project work. These drawings become the As-Fitted drawings for the project

work. The Contractor is responsible for providing updated vessel drawings affected by the project work to the TA prior to completion of the contract. The affected drawings must be submitted in the following formats:

- a) Five (5) plotted copies of the latest revision of each of the As-Fitted drawings;
- b) Two (2) electronic copies of the latest revision of each As Fitted drawing.

8.3.3. Plotted drawings must be on standard ANSI paper sizes.

8.3.4. Marked up drawings must be AutoCAD drawings where original AutoCAD drawings are provided. If no AutoCAD drawings were provided then scanned files (raster format) must be supplied to CCG in one of the following formats:

- a) DXF format;
- b) TIFF format;
- c) PDF format.

## 9. Manuals

9.1. This section, must be referred to as the Manuals section of the General Notes, is intended must be used as reference for the minimum standards when specified deliverables must be manuals.

### 9.2. General

9.2.1. Instruction Manuals must be individually bound in a hard cover 3 ring book format with a page size of 8 1/2" x 11". Drawings must be legible and if of a larger size must be concertina folded to suit. The covers must have the following information printed thereon:

- a) Name of Vessel
- b) Equipment Identification;
- c) Equipment Manufacturer;
- d) Date.

9.2.2. Plastic tabbed indices must be provided for all sections of the manuals. Major equipment components must be subdivided into separate sections of the manuals.

9.2.3. A master index must be provided at the beginning of each binder indicating all items included in each section.

9.2.4. A list of names, addresses and telephone numbers of contacts associated with the equipment manufacturers must be provided that can be used after the project completion for maintenance and information data purposes.

9.2.5. A copy of the final reviewed and approved As-Fitted Drawing(s) must be provided within the maintenance manual.

9.2.6. One (1) electronic copy of each manual must be provided in accordance with the Data Book section of this specification.

9.2.7. Two (2) hard copies of manuals and data sheets must be supplied in English for all Contractor Furnished Equipment items.



### **9.3. Operation Manuals – As-Fitted**

9.3.1. Operation manuals must include the following items:

- a) General description of equipment operating sequence;
- b) Step by step procedure to follow in commissioning the equipment;
- c) Schematic wiring diagram for the fitted equipment; and
- d) All pertinent equipment performance criteria.

9.3.2. Where software/hardware systems are fitted, the operation manual must include the full software documentation manual in paper form for the system and an electronic copy in accordance with the Documentation Section. The minimum software documentation must include:

- a) System level diagrams describing the overall scheme of the software/hardware system;
- b) The functional specifications, which must describe in detail the functional capabilities of the system and each software components; and
- c) Project specific program listings including all comments describing the details of the code functions.

### **9.4. Maintenance Manuals – As-Fitted**

9.4.1. Maintenance manuals must include:

- a) Manufacturer's maintenance instructions for each item of the equipment requiring maintenance activity;
- b) Instructions must include installation instructions, part numbers, part lists, master drawings and exploded views with part identification for all mechanical, electrical and electronic parts, name of suppliers;
- c) Summary list of each item of the equipment requiring lubrication, indicating the name of the equipment item, location of all points of lubrication, type of lubricant recommended, and frequency of lubrication; and
- d) Troubleshooting sections must be included for all equipment in the maintenance manual under a separate heading.

## **10. Identification**

### **10.1. Nameplates**

10.1.1. Nameplates are identified as a deliverable in the individual specification item requesting them.

10.1.2. All nameplates must be in English, except where required in English and French by RO for reasons of emergency operation.

10.1.3. Lettering must be clear and concise with the minimum use of abbreviations. Primary information must be given in larger size lettering than secondary information.

10.1.4. The type of nameplates must suit the location in the vessel as specified below:

**10.2. Plastic:**

- a) Laminated plastic nameplates, black with white core engraved through to the center core, must be provided for all devices located on the exterior surfaces of switchboards, or local control panels. Nameplates must be secured to the equipment with machine screws.
- b) New nameplates must be fitted on the existing equipment must be consistent in size and lettering with those already fitted or those being replaced.
- c) Nameplates indicating feeder circuits must identify each circuit by name and number and the fuse size or trip element rating.
- d) The Following Labels must be of laminated plastic, red with white core engraved through to the center core:
  - i. Safe Working Loads,
  - ii. Warning/Caution labels,
  - iii. Circuit breakers with shunt trips requiring completion of remote circuits prior must being operated,
  - iv. Equipment with multiple power sources,
  - v. Circuit breaks having a potential power source connected to both sides
  - vi. Indication of any other potentially hazardous condition.

**10.3. Engraved on Metal:**

- 10.3.1. Must be used in machinery spaces and where exposed to the weather or susceptible to covering by paint, oil or grease. Nameplates exposed to weather must be stainless steel or brass. Engraved metal nameplates must be of stainless steel or brass with lettering accentuated by means of black wax unless otherwise noted, and secured with stainless steel or brass machine screws.
- 10.3.2. A complete list of nameplates, detailing size of plate, size of lettering and inscription must be submitted to the TA for review prior to ordering and/or manufacturing.

**10.4. Wire Labelling**

- 10.4.1. Wire Labeling is identified as a deliverable in the individual specification item requesting them.
- 10.4.2. All permanently installed cables must be tagged with the circuit designation at all points of connection and on both sides of bulkheads, decks, etc. Tags must be of metal compatible with the armor or cable sheathing. Both ends of the tags must be strapped to the cable with compatible metal strap after all painting has been completed. Straps must pass through holes in the tags so that tags are positively secured. Strap ends must be permanently folded and crimped. Adhesives of any kind will not be acceptable.
- 10.4.3. All wiring in panels specified must be labeled must be labeled with the Cable Number and their conductor # unless otherwise specified in equipment installation drawings.

	MLB	
Spec Item #: H-2	SPECIFICATION	
FIRE DETECTION SYSTEM		

## 1. PART 1 - SCOPE

- 1.1.** The intent of this specification is for the Contractor to arrange for the inspection, modification, testing and recertification of the vessels fixed and portable fire extinguishing equipment.
- 1.2.** The Contractor must provide all new warning signs for the vessel. These must be red background with white letters. The signs must be provided in both English and French. The required signs are shown in Appendix C – Fire System Signage.
- 1.3.** The Contractor must provide a Kidde Marine FSR to supply and install the required hardware for Integrated Logistic Support for the Kidde CO2 system. The system must be brought up to current marine system safety standards.
- 1.3.1. The Engine Room Smoke Detector must be replaced with type approved Smoke Detector
- 1.3.2. The Engine Room Heat Detector must be replaced with a dual action rate-of-rise and fixed temperature resettable type detector.
- 1.3.3. The existing CO2 System requires two (2) replacement Exterior Pull Station Enclosures, two (2) Replacement Pressure Switches, two (2) Replacement Dual Pull Mechanisms
- 1.3.4. The Existing CO2 system arrangement must be modified to include one (1) Supervised lock-out valve, One (1) Safety Relief device and 1x Discharge Indicator.

## 2. PART 2 – REFERENCES

### 2.1. Guidance Drawings/Nameplate Data

- 2.1.1. Drawing Number 47B MLB 436-014 – Control and Alarm Systems (Fire Alarm System)
- 2.1.2. Drawing Number 47B MLB 436-012 – Control and Alarm Systems (CO2 System)
- 2.1.3. Drawing Number 47B MLB 300-020 – Electrical One Line Diagram
- 2.1.4. Drawing Number 47B MLB 436-017 – Control and Alarm Systems (General Alarm)
- 2.1.5. Drawing Number 47B MLB 505-025 – Piping Arrangements in Hull (CO2 System)
- 2.1.6. Kidde Marine Carbon Dioxide DIOM (PN 220610)

### 2.2. Standards

- 2.2.1. Fleet Safety and Security Manual (DFO/5737)
- 2.2.2. See General Notes H-1

### 2.3. Regulations

- 2.3.1. VFSR SOR/2017-14
- 2.3.2. NFPA 12 – Ch 9.
- 2.3.3. Canada Shipping Act 2001 – Marine Machinery Regulations (SOR/90-264)
- 2.3.4. Maritime Occupational Health and Safety Regulations (SOR/87-183)
- 2.3.5. See General Notes H-1

## **2.4. Government Furnished Material**

2.4.1. N/A

## **2.5. Contractor Furnished Material**

2.5.1. The Contractor must supply everything that is required to perform the specified work unless otherwise stated, such as but not limited to the following: labour, materials, parts, tools, consumables, equipment, machinery, storage, shelters, staging, rigging, scaffolding, enclosures, power and heating.

2.5.2. Required materials are listed in 3.1.2.1.6

## **3. PART 3 – TECHNICAL DESCRIPTION**

### **3.1. General**

3.1.1. The Contractor must acquire the services of a TCMS RO approved fire protection service agency for fire detection systems to provide components, technical removal and installation guidance, commissioning and set to work for the fire detector replacement specification

3.1.1.1.1. The Contractor must remove the existing heat and fire detectors from the engine room of the vessel.

3.1.1.1.2. The smoke detector for the Engine Room must be Consilium Conventional Smoke Detector EC-P and include the base and base adaptor (5200175-00A + 5200178-00A + 046950).

3.1.1.1.3. The Heat Detector must be Kidde-Fenwal 27121-20 @ 225F. (Temperature must be above max expected ambient temperature, Temp must be provided by Canadian Coast Guard). 225F is an estimate only.

3.1.1.1.4. Where modifications are required to the existing General Alarm System this will be dealt with via PSPC 1379 action.

3.1.1.1.5. The Contractor is responsible for all electrical modifications and installations

3.1.1.1.6. Data Sheets must be supplied to the contractor which indicates thread size, gland size, and terminal connections required for all components.

3.1.2. The Contractor must acquire the services of a class approved and certified Kidde Fire Suppression System FSR to provide components, technical removal and installation guidance, commissioning and set to work for the carbon dioxide (CO<sub>2</sub>) modification specification. All piping, bracketing, penetrations, electrical and installation materials are the responsibility of the contractor. Pipe/tubing sizes are noted on the supplied drawings. All new equipment is listed in 3.1.2.1.6

3.1.2.1.1. All disconnects and reconnects of mechanical hardware for the CO<sub>2</sub> system must be completed by the FSR.

3.1.2.1.2. The two (2) Kidde 50lb CO<sub>2</sub> cylinders must be removed by the FSR and emptied of CO<sub>2</sub>, valves rebuilt, hydrostatically tested and

cylinders recharged. Rigging and transportation must be the responsibility of the Contractor. Final Weights and liquid level of cylinders must be recorded. A printed Hydrostatic test record must be provided as part of final certification deliverable.

3.1.2.1.3. The following components are showing signs of deterioration and must be removed from the vessel and replaced with new. Two (2) 3PDT Pressure Switches, two (2) Manual Pull Boxes (Exterior). Refer to supplied CO2 Arrangement drawings for equipment locations

3.1.2.1.3.1. The Contractor is responsible for all non-critical Electrical Disconnects and Reconnects

3.1.2.1.4. The Following equipment is not listed for use in Kidde Marine CO2, Tee-Pulley. They must be removed from the vessel and replaced with Kidde Dual Pull Mechanism. All stainless-steel cable must be removed from the vessel and replaced with new, Kidde PN 06-118316-100 or equivalent.

3.1.2.1.5. The following two items must be removed from the vessel and fitted with new: Kidde ½” flexible discharge hose (x2)

3.1.2.1.6. The required items for the Integrated Logistics Support are listed below.

- One (1) 10611108 Stainless Steel Lockout Valve with Limit Switch. (Bridge indication of Lockout Position must be provided by the contractor. Dash LED must indicate position of Valve. (Valve must be positioned before the discharge delay and siren line in CO2 manifold.
- Two (2) Dual Pull Mechanism – 81-840058-000 (replaces T-pulley at CO2 Cylinders)
- Two (2) Mechanical Pull Box – 81-871403-000
- Two (2) Pressure Operated Switches – 81-486536-000
- One (1) Safety Outlet – 81-803242-000 (must be piped/vented to exterior, must be located in closed section of pipe)
- One (1) Discharge Indicator – 81-967082-000 (must be located in closed section of pipe)
- Two (2½) Kidde Flexible CO2 Hose - 81-252184-000
- Two (2) Kidde Valve Rebuild Kits (1/2”) – 81-994706-500
- Approximately 10x Corner Pulley - WK-844648-000
- Data sheets must be supplied to the contractor which indicates thread size, gland size, and terminal connections required for each component.

3.1.3. The Contractor must ensure the separation between the Engine Room, Survivor Compartment and Auxiliary Machine Room remains gastight. All hatches and doors must be inspected by the contractor to ensure all seals are intact and provide the required protection.

- 3.1.4. The Contractor must acquire the services of a class approved fire protection service agency to inspect the vessels fire extinguishers. Where deficiencies or corrective actions are required these will be dealt with via PSPC 1379 action.
- 3.1.4.1. Where fire extinguishers must be removed from the vessel for service, equivalent quantity and type must be left in place.
- 3.1.5. The Contractor must remove all fire system signage from the vessel.
- 3.1.6. The Contractor must provide all new signs in both English and French. The signs are listed in Appendix C with dimensions. The contractor must ensure these are permanently affixed to the vessel using adhesive or equivalent. The signs must have red background with white text.
- 3.1.6.1. Operational Signs for the CO2 system must be modified to the following and be read vertically for the exterior sign:

“TO ACTIVATE CO2 EXTINGUISHING SYSTEM

- 1. ENSURE ALL PERSONNEL HAVE EVACUATED THE SPACE
- 2. CLOSE ALL OPENINGS, VENTILATION & FUEL SOURCES TO THE ENGINE ROOM
- 3. BREAK GLASS (MAIN) & PULL HANDLE  
SYSTEM WILL ACTIVATE IN 30 SEC.
- 4. IF FIRE IS NOT FULLY EXTINGUISHED AFTER DISCHARGE BREAK GLASS (RESERVE) & PULL HANDLE.
- 5. IF SYSTEM FAILS TO ACTIVATE GO TO CYLINDERS.”

“POUR ACTIVER LE SYSTÈME D'EXTINCTION CO2

- 1. ASSUREZ-VOUS QUE TOUT LE PERSONNEL A ÉVACUÉ L'ESPACE
- 2. FERMER TOUTES LES OUVERTURES, LA VENTILATION ET LES SOURCES DE CARBURANT À LA SALLE DES MACHINES
- 3. BRISEZ LE VERRE (PRINCIPAL) ET LA POIGNÉE DE TIRAGE  
LE SYSTÈME S'ACTIVERA DANS 30 SECONDES.
- 4. SI LE FEU N'EST PAS COMPLÈTEMENT ÉTEINT APRÈS LA DÉCHARGE, BRISEZ LE VERRE (RÉSERVEZ) ET TIRER LA POIGNÉE.
- 5. SI LE SYSTÈME NE S'ACTIVE PAS, ALLEZ AUX CYLINDRES. »

### **3.2. Location**

- 3.2.1. Engine room, auxiliary machinery space, signage and extinguishers throughout vessel

### **3.3. Interferences**

- 3.3.1. The Contractor is responsible for identifying all interface items, their removal storage and subsequent installation upon approval of the TA.

#### **4. PART 4 – PROOF OF PERFORMANCE**

##### **4.1. Inspection**

- 4.1.1. A visual verification inspection by the Contractor and TA in attendance, of general workmanship including that of piping, hardware, materials, and coatings must be conducted.
- 4.1.2. The Smoke and Heat detectors must be inspected and certified for operation by a Class Approved Fire Protection Service Agency.
- 4.1.3. The fixed CO2 system must be inspected and certified by a Class Approved and Kidde Factory Certified FSR.
- 4.1.4. The portable fire extinguishers must be inspected and certified for operation by a Class Approved Fire Protection Service Agency.
- 4.1.5. The Contractor is responsible for arranging with the TA for inspection of all firefighting equipment and fire detection systems.

##### **4.2. Testing**

- 4.2.1. The service provider must test and confirm the operation of the all fire system devices after installation.
- 4.2.2. The two (2) Kidde 50lb CO2 cylinders must be hydrostatically tested by a TC approved hydrotest facility.
- 4.2.3. All heat and smoke detectors must be tested for proper operation and reset to active monitoring status. All alarms and indicators must be tested for proper operation.
- 4.2.4. Upon completion the system must be tested for operation by using test CO2 gas. The following items must be tested and proven operational. Where components fail during testing, they will be replaced via PSPC 1379 action:
- Discharge Delay – Test and record time.
  - Nozzles are proven clear
  - Pressure Switch Operation
  - Fan/HVAC Shutdown (where applicable)
  - Discharge Indicator
  - CO2 Discharge Alarm and Status Signals
  - Check Valves (main & reserve)
  - Manual Pull Cables and Actuators.
  - Lockout valve - position indication
- 4.2.5. All portable fire extinguishers must be serviced in accordance with the applicable VFSR and Manufacturer requirements. Upon completion of tests all extinguishers must be certified for operation.

##### **4.3. Certification**

- 4.3.1. The Contractor must deliver to the TA an original, RO approved certification that the system is inspected and compliant with applicable Transport Canada Marine Regulations pursuant to the Canada Shipping Act.

## **5. PART 5 - DELIVERABLES**

### **5.1. Drawings/Reports**

- 5.1.1. The Contractor must mark up the Coast Guard supplied drawings in red to detail each modification made by the Contractor to the system and equipment changes. The Contractor must deliver a new, RO approved, as fitted drawing.
- 5.1.2. The Contractor must supply a final report in two (2) electronic PDF copies on a USB flash drive to the TA upon completion of the above noted scope of work. The final report must contain the results of testing which may include but not limited to: cylinder weights, equipment serial numbers and dates, recommendations, function testing results, delay times etc.
- 5.1.3. All certificates and service reports issued by the contractor for this work must reference each serviced component serial number, location or equipment ID.

### **5.2. Spares**

- 5.2.1. Any remaining spare parts that were purchased, but not used, for this specification must be supplied to the TA for onboard spares. Contractor to supply the TA all spare parts receipts with a paper or electronic PDF copy of the spare parts list for warranty purposes.

5.2.2.

### **5.3. Training**

- 5.3.1. N/A

### **5.4. Manuals**

- 5.4.1. The Contractor must include all associated manuals related to this specification as described in H-1 General Notes - Section 7 - Manuals



	MLB	
Spec Item #: H-3	SPECIFICATION	
<b>ADD DAMPERS ON THE VENILATION DUCT BETWEEN THE SURVIVOR COMPARTMENT AND THE WHEELHOUSE</b>		

## 1. PART 1 - SCOPE

- 1.1. The intent of this specification is to provide for a fire damper in the ventilation line between the survivor compartment and wheelhouse.

## 2. PART 2 – REFERENCES

### 2.1. Guidance Drawings/Nameplate Data

- 2.1.1. Drawing Number 47B MLB 513-010 – Machinery Space Ventilation  
2.1.2. Drawing Number 47B MLB 513 010 – Supplementary Ventilation Engine Intake Ducting  
2.1.3. Drawing Number 47B MLB 160-010 – Built in Ventilation Ducts

### 2.2. Standards

- 2.2.1. See General Notes H-1

### 2.3. Regulations

- 2.3.1. See General Notes H-1

### 2.4. Government Furnished Material

- 2.4.1. N/A

### 2.5. Contractor Furnished Material

- 2.5.1. The Contractor must supply everything that is required to perform the specified work unless otherwise stated, such as but not limited to the following: labour, materials, parts, tools, consumables, equipment, machinery, storage, shelters, staging, rigging, scaffolding, enclosures, power and heating.

## 3. PART 3 – TECHNICAL DESCRIPTION

### 3.1. General

- 3.1.1. The Contractor must ensure prior to any work commencing, that both the Contractor Basic Safety Familiarization and Pre Job Safety Assessment are completed and signed off.  
3.1.2. The Contractor must cut out a section of the vent trunking on the after end of the enclosed bridge and remove a section of sufficient length to install a Contractor supplied manually operated damper.  
3.1.3. The damper must be capable of being locked in the “open” or “closed position and must also be clearly “open” and “closed”.

- 3.1.4. The contractor must use care to not damage the surrounding equipment and aluminum structure.
- 3.1.5. The Contractor must install damper in existing trunking ensuring damper control does not obstruct passage in front of damper.
- 3.1.6. The Contractor must consult the Technical Authority to approve location and placement of the damper.
- 3.1.7. The Contractor must clean and paint the completed work to match surrounding area.
- 3.1.8. The Contractor must verify the function of the damper.

**3.2. Location**

- 3.2.1. After bulkhead of enclosed bridge.

**3.3. Interferences**

- 3.3.1. The Contractor is responsible for the identification of all interference items, their temporary removal, secure storage, and refitting to the vessel.

**4. PART 4 – PROOF OF PERFORMANCE**

**4.1. Inspection**

- 4.1.1. A visual inspection by the Contractor and TA in attendance, of general workmanship including that of piping, hardware, materials, and coatings must be conducted.
- 4.1.2. Refer to Regulations in H-1 General Notes

**4.2. Testing**

- 4.2.1. The Contractor must demonstrate all functions of the damper to the Technical Authority. The Contractor must correct any deficiencies found.

**4.3. Certification**

- 4.3.1. N/A

**5. PART 5 - DELIVERABLES**

**5.1. Drawings/Reports**

- 5.1.1. Contractor must produce two (2) electronic PDF copies of a final report for the TA upon completion of the above noted scope of work. The final report must contain the results of all inspections, testing, manufacturer information, part numbers and details of work completed.
- 5.1.2. The Contractor must include all associated documentation related to this specification as described H-1 General Notes - Section 5 – Documentation

5.1.3. The Contractor must include revised as fitted drawings as described in H-1 General Notes - Section 6 - Drawings.

**5.2. Spares**

5.2.1. N/A

**5.3. Training**

5.3.1. N/A

**5.4. Manuals**

5.4.1. N/A

	MLB	
Spec Item #: H-4	SPECIFICATION	
<b>REPLACE QUICK CLOSE FUEL VALVES AND ACTUATORS</b>		

## **1. PART 1 - SCOPE**

- 1.1.** The intent of this specification is to replace the two existing quick closing fuel valves and actuators with two equivalent units of the same size and function. Two trip lines must also be replaced.
- 1.2.** The Work must be done in conjunction with H-29 Fuel Tank and E-108 Replace Fuel Gauges and Senders.

## **2. PART 2 – REFERENCES**

### **2.1. Guidance Drawings/Nameplate Data**

- 2.1.1. Drawing Number 47B MLB 110-620 – Survivors Compartment Arrangement
- 2.1.2. Drawing Number 47B MLB 505-024 – Fuel System Piping Arrangement

### **2.2. Standards**

- 2.2.1. See General Notes H-1

### **2.3. Regulations**

- 2.3.1. See General Notes H-1

### **2.4. Government Furnished Material**

- 2.4.1. N/A

### **2.5. Contractor Furnished Material**

- 2.5.1. The Contractor must supply everything that is required to perform the specified work unless otherwise stated, such as but not limited to the following: labour, materials, parts, tools, consumables, equipment, machinery, storage, shelters, staging, rigging, scaffolding, enclosures, power and heating.
- 2.5.2. Refer to Appendix A for List of Original Suppliers or Appendix B for List of Alternate/Additional Suppliers

## **3. PART 3 – TECHNICAL DESCRIPTION**

### **3.1. General**

- 3.1.1. The Contractor must ensure prior to any work commencing, that both the Contractor Basic Safety Familiarization and Pre Job Safety Assessment are completed and signed off
- 3.1.2. The Contractor must remove the existing valves using care to not damage the aluminum deck and any equipment in the space.

- 3.1.3. The Contractor must clean and inspect bulkhead exposed by removal of the valves. Prior to installation of the new valves it must be inspected by the technical authority.
- 3.1.4. The Contractor, at a minimum, must repair coating systems disturbed as a result of the specified work. Coating systems must be in accordance with the coating system of the vessel, and be applied in accordance with the paint manufacturer's recommended procedures.
- 3.1.5. The Contractor must install the new valves and actuators to existing attachments.
- 3.1.6. The Contractor must install new pull handles and cables as per existing arrangement.
- 3.1.7. The Contractor must verify the function of the valves and actuators in accordance with the manufacturer's manual.
- 3.1.8. Valves must not be purchased until certification is reviewed and approved by the Technical Authority.

**3.2. Location**

- 3.2.1. Engine Room

**3.3. Interferences**

- 3.3.1. The Contractor is responsible for the identification of all interference items, their temporary removal, secure storage, and refitting to the vessel.

**4. PART 4 – PROOF OF PERFORMANCE**

**4.1. Inspection**

- 4.1.1. All work carried out must be verified correct and approved by the Technical Authority and the attending RO Class inspector or TCMS as required

**4.2. Testing**

- 4.2.1. The Contractor must demonstrate all functions of the valves and actuators to the Technical Authority and the attending RO Class inspector. The Contractor must correct any deficiencies found and retest the valves.
- 4.2.2. Valves must be examined for leaks in open and closed positions, when the fuel tank is filled, and when the engines are running.
- 4.2.3. Quick closing capability of the valves must function in accordance with manufacturer's guidelines.

**4.3. Certification**

- 4.3.1. Refer to Regulations in H-1 General Notes

**5. PART 5 – DELIVERABLES**

**5.1. Drawings/Reports**

- 5.1.1. The Contractor must produce two (2) electronic PDF copies of a final report for the TA upon completion of the above noted scope of work. The final report must contain the results of all inspections, testing, manufacturer information, part numbers and details of work completed..
- 5.1.2. The Contractor must include all associated documentation related to this specification as described H-1 General Notes - Section 5 – Documentation
- 5.1.3. If any alterations from the original drawings have been made, the Contractor must include revised as fitted drawings as described in H-1 General Notes - Section 6 - Drawings.
- 5.2. Spares**
- 5.2.1. N/A
- 5.3. Training**
- 5.3.1. The Contractor must demonstrate the operation of the valves to the Technical Authority.
- 5.4. Manuals**
- 5.4.1. The Contractor must include all associated manuals related to this specification as described in H-1 General Notes - Section 7 - Manuals

	MLB	
Spec Item #: H-5	SPECIFICATION	
<b>SACRIFICIAL ANODES</b>		

## **1. PART 1 - SCOPE**

- 1.1.** The intent of this specification is to replace the sacrificial anodes on the exterior hull and propeller shafts.
- 1.2.** Depending on the geographical location of the vessel, the sacrificial anodes may be Zinc, Magnesium or Aluminium. Contractor to consult the Technical Authority for verification.

## **2. PART 2 – REFERENCES**

### **2.1. Guidance Drawings/Nameplate Data**

- 2.1.1. Drawing Number 47B MLB 633-010 – Cathodic Protection

### **2.2. Standards**

- 2.2.1. See General Notes H-1

### **2.3. Regulations**

- 2.3.1. See General Notes H-1

### **2.4. Government Furnished Material**

- 2.4.1. N/A

### **2.5. Contractor Furnished Material**

- 2.5.1. The Contractor must supply everything that is required to perform the specified work unless otherwise stated, such as but not limited to the following: labour, materials, parts, tools, consumables, equipment, machinery, storage, shelters, staging, rigging, scaffolding, enclosures, power and heating.
- 2.5.2. Refer to Appendix A for List of Original Suppliers or Appendix B for List of Alternate/Additional Suppliers

## **3. PART 3 – TECHNICAL DESCRIPTION**

### **3.1. General**

- 3.1.1. The sacrificial anodes on the hull and shaft must be removed and disposed of in accordance with local regulations. Missing or wasted anodes must be replaced with new anodes; all old straps must be examined for damage and identified for replacement where required.
- 3.1.2. The Contractor must quote on supplying and installing two (2) 10 kilogram anodes with aluminum straps and four (4) collar type shaft anodes for a 2 ½ inch diameter shaft. The Contractor must measure with a digital multi-meter (i.e. Fluke 83) the resistance between the installed shaft anodes and the bare propeller shaft. The resistance must be below two (2) ohms.

3.1.3. All new hull anodes must be affixed prior to hull coating. The anodes must be protected during hull painting and the protection must be removed prior to refloating.

3.1.4. Any disturbed aluminum work must be coated as per the paint scheme in the area.

### **3.2. Location**

3.2.1. External Hull

### **3.3. Interferences**

3.3.1. The Contractor is responsible for the identification of interference items, their temporary removal, storage, and refitting to vessel.

## **4. PART 4 – PROOF OF PERFORMANCE**

### **4.1. Inspection**

4.1.1. All work carried out must be verified correct by and approved the Technical Authority and the attending RO Class inspector as required

4.1.2. Refer to Regulations in H-1 General Notes

### **4.2. Testing**

4.2.1. The Contractor must measure with a digital multi-meter (i.e. Fluke 83) the resistance between the installed anodes and bare propeller shaft. The resistance must be below two (2) ohms.

4.2.2. The Contractor must measure with a digital multi-meter (i.e. Fluke 83) the resistance between the installed anodes on the stern and the hull. The resistance must be below two (2) ohms.

### **4.3. Certification**

4.3.1. N/A

## **5. PART 5 – DELIVERABLES**

### **5.1. Drawings/Reports**

5.1.1. The Contractor must produce two (2) electronic PDF copies of a final report for the TA upon completion of the above noted scope of work. The final report must contain the results of all inspections, testing, manufacturer information, part numbers and details of work completed..

5.1.2. The Contractor must include all associated documentation related to this specification as described H-1 General Notes - Section 5 - Documentation

### **5.2. Spares**

5.2.1. N/A

### **5.3. Training**

5.3.1. N/A

### **5.4. Manuals**



5.4.1. N/A

	MLB	
Spec Item #: H-6	SPECIFICATION	
SANDBLAST AND PAINT HULL		

## 1. PART 1: SCOPE:

- 1.1. The intent of this spec is to grit blast the hull, coat the entire hull and to paint draft marks marks.
- 1.2. The work must be done in conjunction with H-1 Sacrificial Anodes and H-7 Hull Inspection and Inserts

## 2. PART 2: REFERENCES:

### 2.1. Guidance Drawings/Nameplate Data

- 2.1.1. Drawing Number 47B MLB 631-010 – Hull Visual Identification

### 2.2. Standards

- 2.2.1. See General Notes H-1
- 2.2.2. Must be approved by a Government supplied NACE Inspector.

### 2.3. Regulations

- 2.3.1. See General Notes H-1

### 2.4. Government Furnished Material

- 2.4.1. N/A

### 2.5. Contractor Furnished Material

- 2.5.1. The Contractor must supply everything that is required to perform the specified work unless otherwise stated, such as but not limited to the following: labour, materials, parts, tools, consumables, equipment, machinery, storage, shelters, staging, rigging, scaffolding, enclosures, power and heating.
- 2.5.2. The underwater hull must be coated with Intershield 300 aluminum epoxy anti-corrosive coating, using Intergard 263 epoxy as the tie-coat, top-coated with Tri-Lux II anti-fouling in black.
- 2.5.3. Wetted Hull Markings must be coated with Interlux Micron CSC used on underwater hull.
- 2.5.4. Above Waterline Hull Areas must be coated with (Red) Interprime 198 marine grade alkyd primer top coated with Interthane 990 polyurethane.

- 2.5.5. Above Waterline Hull Areas (White and Black Stripes) must be coated with Interprime 198 marine grade alkyd primer top coated with Interthane 990 polyurethane.
- 2.5.6. Above Water Hull Markings must be coated with Interthane 990 polyurethane.
- 2.5.7. The Contractor must adhere to the coating/paint manufacturer's guidelines at all times.
- 2.5.8. Refer to Appendix A for List of Original Suppliers or Appendix B for List of Alternate/Additional Suppliers

### **3. PART 3: TECHNICAL DESCRIPTION:**

#### **3.1. General**

- 3.1.1. The Contractor must ensure prior to any work commencing, that both the Contractor Basic Safety Familiarization and Pre Job Safety Assessment are completed and signed off
- 3.1.2. The Contractor must hydro blast the ships' hull within 2 hours of dry docking to remove all marine growth. Upon completion of hydro blasting, the contractor and Technical Authority must inspect the hull and agree upon a total square meter of hull must be grit blasted. The Contractor must supply the required scaffolding and/or man lift to carry out the required inspection.
- 3.1.3. Prior to any grit blasting taking place, the contractor must ensure all appropriate areas of the vessel are covered to prevent the ingress of grit. These areas include, but are not limited to,
  - i. All exhaust outlets,
  - ii. All tank vents,
  - iii. All air intake and exhaust plenums,
  - iv. All scupper pipes,
  - v. All overboard discharges,
  - vi. All sea bays and chest,
  - vii. Stern tube,
  - viii. Rudder stock gland,
  - ix. Sacrificial anodes and
  - x. Transducers.
- 3.1.4. All deck machinery including wires must be protected and any window/portholes that may be affected.
- 3.1.5. All sea bay grids must be protected from both the grit blasting and hull coating.
- 3.1.6. The Contractor must grit blast all damaged areas of the hull coating to SA 2.5, edges feathered to provide a suitable surface for the new coating to adhere. Entire underwater hull area must be sweep blast to SSPC-SP7.
- 3.1.7. The Contractor must provide unit cost for grit blasting per square meter.

- 3.1.8. The Contractor must remove all grit from the hull prior to any painting application.
- 3.1.9. All sacrificial anodes must be removed and new anodes installed prior to application of hull coating.
- 3.1.10. All blasted areas must be inspected and approved by the attending NACE Inspector prior to entire underwater hull being coated.
- 3.1.11. The Contractor must provide unit cost for coating repair per square meter.
- 3.1.12. Coating must be mixed and applied according to the manufactures recommendation and to the satisfaction of the NACE Inspector.
- 3.1.13. All blasted areas must be coated and allowed to cure as per manufacturer's coating application guidelines.
- 3.1.14. The waterline must be cut in and all draft marks, load lines and hull symbols must be painted using Interthane 990 polyurethane white.
- 3.1.15. All coating and paints must be contractor supplied.

**3.2. Location**

- 3.2.1. Entire hull area.

**3.3. Interferences**

- 3.3.1. The Contractor is responsible for the identification of all interference items, their temporary removal, storage, and refitting to the vessel.

**4. PART 4: PROOF OF PERFORMANCE:**

**4.1. Inspection**

- 4.2. The Coast Guard will be retaining the services of a NACE Inspector.

- 4.2.1. All work carried out must be verified correct and approved by the Technical Authority, the attending NACE Inspector and the attending RO Class inspector or TCMS as required.

- 4.2.2. Refer to Regulations in H-1 General Notes.

**4.3. Testing**

- 4.3.1. The NACE Inspector must be required to inspect and approve the preparation and application of all hull coatings.

**4.4. Certification**

- 4.4.1. Refer to Regulations in H-1 General Notes.

**5. PART 5: DELIVERABLES:**

**5.1. Drawings/Reports**

- 5.1.1. The Contractor must produce two (2) electronic PDF copies of a final report for the TA upon completion of the above noted scope of work. The final report must contain the results of all inspections, testing, manufacturer information, part numbers and details of work completed..
- 5.1.2. The Contractor must include all associated documentation related to this specification as described H-1 General Notes - Section 5 – Documentation.
- 5.1.3. Copy of the manufactures MSDS for the coating being applied must be supplied to the Technical Authority.

**5.2. Spares**

- 5.2.1. N/A

**5.3. Training**

- 5.3.1. N/A

**5.4. Manuals**

- 5.4.1. N/A

	MLB	
Spec Item #: H-7	SPECIFICATION	
<b>HULL INSPECTION AND INSERTS</b>		

## **1. PART 1 - SCOPE**

- 1.1.** The intent of this specification is for the Contractor to carry out a hull inspection and non-destructive testing on the hull and structure of the vessel.
- 1.2.** The Contractor must include a quote for the provision of twenty (20) UT Shots as indicated in 3.1.2.
- 1.3.** This work must be carried out in Conjunction with the following:
- H-18 Docking
  - H-6 Sandblast and Paint Hull
  - H-5 Sacrificial Anodes

## **2. PART 2 - REFERENCES**

### **2.1. Guidance Drawings/Nameplate Data**

- 2.1.1. Drawing Number 47B MLB 110-500 - Shell Plating

### **2.2. Standards**

- 2.2.1. See General Notes H-1

### **2.3. Regulations**

- 2.3.1. See General Notes H-1

### **2.4. Government Furnished Material**

- 2.4.1. N/A

### **2.5. Contractor Furnished Material**

- 2.5.1. The Contractor must supply everything that is required to perform the specified work unless otherwise stated, such as but not limited to the following: labour, materials, parts, tools, consumables, equipment, machinery, storage, shelters, staging, rigging, scaffolding, enclosures, power and heating. must
- 2.5.2. Refer to Appendix A for List of Original Suppliers or Appendix B for List of Alternate/Additional Suppliers.

## **3. PART 3 – TECHNICAL DESCRIPTION**

### **3.1. General**

- 3.1.1. After docking and hull cleaning the Contractor along with the Technical Authority and ABS Class Surveyor must carry out a visual inspection of the underwater hull of the vessel. This item must be carried out prior to the hull painting.

- 3.1.2. The Contractor must obtain the services of an ABS Certified company to carry out a minimum twenty (20) UT Shots for the hull and structure of the vessel. Individual taking the readings must be minimum Level 2 Certified. The Contractor must also include the unit cost per shot including prepping, priming and person lift and operator. Actual cost must be adjusted up or down via PSPC 1379 action.
- 3.1.3. The Contractor must carry out the hull inspection and the ultrasonic inspection.
- 3.1.4. The shots must be taken in the areas designated by the Technical Authority.
- 3.1.5. In areas where poor readings are found additional shots must be taken to confirm the extent of the wastage.
- 3.1.6. Contractor must inform the CG Technical Authority and RO Class Surveyor at least five(5) days prior to the shots being taken so that their attendance can be planned. Contractor must also account for COVID 19 travel restrictions in the area.
- 3.1.7. All plate thicknesses can be obtained from the ships drawings.
- 3.1.8. The Contractor must quote on the cutting out and replacement of one (1) meter square of plating in the area of the batteries. Exact area and extent of cut out must be determined in consultation with the Technical Authority and the RO Class Inspector. Actual area must be adjusted up or down via PSPC 1379 action.
- 3.1.9. The Contractor must remove the plugs from the spray rails (port and starboard bow area of hull) and visually inspect for damage.

### **3.2. Location**

- 3.2.1. Ship's hull and decks

### **3.3. Interferences**

- 3.3.1. The Contractor is responsible for the identification of interference items, their temporary removal, storage, and refitting to vessel.

## **4. PART 4 – PROOF OF PERFORMANCE**

### **4.1. Inspection**

- 4.1.1. All work carried out must be verified correct and approved by the Technical Authority and the attending RO Class Inspector or TCMS as required.
- 4.1.2. Refer to Regulations in H-1 General Notes

### **4.2. Testing**

- 4.2.1. NDT testing of any welds as per CCG Welding Specification CT-043-eg-eq-001
- 4.2.2. Ultrasonic Testing, minimum 20 shots.
- 4.2.3. The Contractor must test the integrity of the spray rails by pressurizing with air to two (2) psi while checking for leaks. The pressure must hold for 30 minutes.

### **4.3. Certification**

- 4.3.1. NDT Technician performing the shots must be minimum Level 2 Certified and certified to do so by RO Class Inspector or TCMS as required.

## **5. PART 5 - DELIVERABLES**

### **5.1. Drawings/Reports**

- 5.1.1. If any plates have been cut out and new plate installed, the Contractor must include revised as fitted drawings, including plate renewal, as described in H-1 General Notes - Section 6 - Drawings.
- 5.1.2. The Contractor must produce two (2) electronic PDF copies of a final report for the TA upon completion of the above noted scope of work. The final report must contain the results of all inspections, testing, manufacturer information, part numbers and details of work completed..
- 5.1.3. The Contractor must ensure NDT Technician supplies detailed reports showing exact locations of each measurement, thickness measured as well as the corresponding original thickness and percentage of wastage found.
- 5.1.4. The Contractor must include all associated documentation related to this specification as described H-1 General Notes - Section 5 - Documentation.

### **5.2. Spares**

- 5.2.1. N/A

### **5.3. Training**

- 5.3.1. N/A

### **5.4. Manuals**

- 5.4.1. N/A



	MLB	
Spec Item #: H-8	SPECIFICATION	
OVERHAUL HATCHES/DOORS		

### 1. PART 1: SCOPE:

1.1. The intent of this specification is to overhaul all the hatches and doors.

### 2. PART 2: REFERENCES:

#### 2.1. Guidance Drawings/Nameplate Data

- 2.1.1. Drawing Number 47B MLB 167-010 – List of Hatches and Manholes
- 2.1.2. Drawing Number 47B MLB 624-010 – Door and Hardware List
- 2.1.3. Drawing Number 47B MLB 150-100 – Upper BHD FR 8
- 2.1.4. Drawing Number 47B MLB 150-050 – Aft Bulkhead
- 2.1.5. Drawing Number 47B MLB 150-040 – Lower BHD FR 8
- 2.1.6. Drawing Number 47B MLB 110-206 – Transv. BHD 5
- 2.1.7. Drawing Number 47B MLB 110-207 – Transv. BHD 8
- 2.1.8. Drawing Number 47B MLB 110-209 – Transv. BHD 10

#### 2.2. Standards

2.2.1. See H-1 General Notes.

#### 2.3. Regulations

2.3.1. See H-1 General Notes

#### 2.4. Government Furnished Material

2.4.1. N/A

#### 2.5. Contractor Furnished Material

- 2.5.1. The Contractor must supply everything that is required to perform the specified work unless otherwise stated, such as but not limited to the following: labour, materials, parts, tools, consumables, equipment, machinery, storage, shelters, staging, rigging, scaffolding, enclosures, power and heating. must
- 2.5.2. Refer to Appendix A for List of Original Suppliers or Appendix B for List of Alternate/Additional Suppliers

### 3. PART 3: TECHNICAL DESCRIPTION:

#### 3.1. General

- 3.1.1. The Contractor must ensure prior to any work commencing, that both the Contractor Basic Safety Familiarization and Pre Job Safety Assessment are completed and signed off.
- 3.1.2. The Contractor must remove existing gaskets and seals on all external doors and hatches.

- 3.1.3. The Contractor must clean the landing surfaces to bare aluminium using hand tools. Cleaned surfaces must be presented to the Technical Authority for approval. Any defects found will be dealt with via PSPC 1379 action.
- 3.1.4. The Contractor must inspect all the doors and hatches for indication of damage or malformation. Damage found will be repaired via PSPC 1379 action.
- 3.1.5. The Contractor must disassemble; examine all hinges and closing mechanisms to check for wear and ensure freedom of operation. The Contractor must lubricate all such mechanisms on completion of the work. Defects must be reported to the Technical Authority and repaired via PSPC 1379 action.
- 3.1.6. The Contractor must repaint the landings, doors and hatches using the paint scheme and materials on the existing doors and hatches.
- 3.1.7. The Contractor must install new Contractor supplied gaskets of the same materials as indicated in the reference drawings.
- 3.1.8. The Contractor must verify the operation of each door and hatch.

### **3.2. Location**

- 3.2.1. Vessel topside

### **3.3. Interferences**

- 3.3.1. The Contractor is responsible for the identification of all interference items, their temporary removal, storage, and refitting to the vessel.

## **4. PART 4: PROOF OF PERFORMANCE:**

### **4.1. Inspection**

- 4.1.1. All work carried out must be verified correct and approved by the Technical Authority and the attending RO Class Inspector or TCMS as required
- 4.1.2. Refer to Regulations in H-1 General Notes

### **4.2. Testing**

- 4.2.1. The Contractor must conduct all specified testing and notify the Technical Authority and RO Class Inspector of the schedule for the testing and inspection.
- 4.2.2. The RO Class Inspector and the Technical Authority must witness all specified testing.
- 4.2.3. Doors and hatches must be tested for leaks using a ½ inch hose at 30 psi, or chalk tested for interior hatches, in presence of Technical Authority and RO Class Inspector. Any leaks found must be corrected and retested.

### **4.3. Certification**

- 4.3.1. N/A

## **5. PART 5: DELIVERABLES:**

### **5.1. Drawings/Reports**

5.1.1. The Contractor must produce two (2) electronic PDF copies of a final report for the TA upon completion of the above noted scope of work. The final report must contain the results of all inspections, testing, manufacturer information, part numbers and details of work completed..

5.1.2. The Contractor must include all associated documentation related to this specification as described H-1 General Notes - Section 5 - Documentation.

**5.2. Spares**

5.2.1. N/A

**5.3. Training**

5.3.1. N/A

**5.4. Manuals**

5.4.1. The Contractor must include all associated manuals related to this specification as described in H-1 General Notes - Section 7 - Manuals.

	MLB	
Spec Item #: H-9	SPECIFICATION	
<b>SUPERSTRUCTURE INSPECTION &amp; REPAIRS</b>		

## **1. PART 1 - SCOPE**

- 1.1.** The intent of this specification is for the Contractor to carry out an inspection and non-destructive testing on the superstructure of the vessel.
- 1.2.** The Contractor must include a quote for the provision of 20 UT Shots as indicated in 3.1.2.
- 1.3.** This work must be carried out in conjunction with:
- H-12 Mast and Buoyancy tank
  - H-10 Windows
  - H-7 Hull Inspection and Inserts

## **2. PART 2 - REFERENCES**

### **2.1. Guidance Drawings/Nameplate Data**

- 2.1.1. Drawing Number 47B MLB 150-010 – Deckhouse Side Starboard
- 2.1.2. Drawing Number 47B MLB 150-020 – Deckhouse Side Port
- 2.1.3. Drawing Number 47B MLB 150-030 – Open Bridge Deck
- 2.1.4. Drawing Number 47B MLB 150-050 – Aft Deckhouse Bulkhead
- 2.1.5. Drawing Number 47B MLB 150-060 – FWD Deck Locker
- 2.1.6. Drawing Number 47B MLB 150-080 – Enclosed Bridge Top
- 2.1.7. Drawing Number 47B MLB 631-010 – Hull Identification

### **2.2. Standards**

- 2.2.1. See General Notes H-1

### **2.3. Regulations**

- 2.3.1. See General Notes H-1

### **2.4. Government Furnished Material**

- 2.4.1. N/A

### **2.5. Contractor Furnished Material**

- 2.5.1. The Contractor must supply everything that is required to perform the specified work unless otherwise stated, such as but not limited to the following: labour, materials, parts, tools, consumables, equipment, machinery, storage, shelters, staging, rigging, scaffolding, enclosures, power and heating. must
- 2.5.2. Refer to Appendix A for List of Original Suppliers or Appendix B for List of Alternate/Additional Suppliers

### **3. PART 3 – TECHNICAL DESCRIPTION**

#### **3.1. General**

- 3.1.1. After completion of the work on windows, doors and hatches the Contractor must acid wash the superstructure and remove all loose paint, grease and dirt. On completion of the acid wash the Contractor must flush the superstructure with fresh water and wipe it dry.
- 3.1.2. The Contractor must obtain the services of an ABS Certified company to carry out a minimum twenty (20) UT Shots of the superstructure structure of the vessel. Individual taking the readings must be minimum Level 2 Certified. Contractor must also include the unit cost per shot including prepping, priming and person lift and operator. Actual cost must be adjusted up or down via PSPC 1379 action.
- 3.1.3. The Contractor must carry out the inspection and the ultrasonic inspection.
- 3.1.4. The shots must be taken in areas designated by the Technical Authority.
- 3.1.5. In areas where poor readings are found additional shots must be taken to confirm the extent of the wastage.
- 3.1.6. The Contractor must inform the CG Technical Authority and RO Class Inspector at least five (5) days prior to the shots being taken so that their attendance can be planned.
- 3.1.7. Original plate thicknesses can be obtained from the ships drawings.
- 3.1.8. The Contractor must quote on the cutting out and replacement of one (1) meter square of plating. Exact area and extent of cut outs must be determined in consultation with the Technical Authority and the RO Class Inspector. Actual area must be adjusted up or down via PSPC 1379 action.
- 3.1.9. The Contractor must paint the entire superstructure using the same paint system and colouring with Interprime 198 marine grade alkyd primer top coated with Interthane 990 polyurethane.
- 3.1.10. The Contractor must replace all decals with new as per Drawing Number 47B MLB 631-010.

#### **3.2. Location**

- 3.2.1. Ships superstructure and upper decks

#### **3.3. Interferences**

- 3.3.1. The Contractor is responsible for the identification of interference items, their temporary removal, storage and refitting to vessel.

### **4. PART 4 – PROOF OF PERFORMANCE**

#### **4.1. Inspection**

- 4.1.1. It is noted that Canadian Coast Guard will provide the services of an independent NACE Inspector.

4.1.2. All work carried out must be verified correct and approved by the Technical Authority and the attending RO Class Inspector or TCMS as required.

4.1.3. Refer to Regulations in H-1 General Notes

**4.2. Testing**

4.2.1. Ultrasonic Testing, minimum 20 shots.

**4.3. Certification**

4.3.1. NDT Technician performing the shots must be minimum Level 2 Certified and certified to do so by ABS.

**5. PART 5 - DELIVERABLES**

**5.1. Drawings/Reports**

5.1.1. The Contractor must produce two (2) electronic PDF copies of a final report for the TA upon completion of the above noted scope of work. The final report must contain the results of all inspections, testing, manufacturer information, part numbers and details of work completed..

5.1.2. The Contractor must ensure NDT Technician supplies detailed reports showing exact locations of each measurement, thickness measured as well as the corresponding original thickness and percentage of wastage found.

5.1.3. The Contractor must include all associated documentation related to this specification as described H-1 General Notes - Section 5 - Documentation.

**5.2. Spares**

5.2.1. N/A

**5.3. Training**

5.3.1. N/A

**5.4. Manuals**

5.4.1. N/A

	MLB	
Spec Item #: H-10	SPECIFICATION	
REFURBISH WINDOWS		

## 1. PART 1: SCOPE:

- 1.1.** The intent of this specification is to refurbish the windows in the wheelhouse and in the survivor space.
- 1.2.** This work must be carried out in conjunction with the topside painting and refurbishment of the mast.
- 1.3.** Work involves the four (4) heated windows on the wheelhouse, two (2) hinged windows in the wheel house, two (2) rectangular and two (2) shaped windows in the wheelhouse and the four (4) windows in the survivor space.

## 2. PART 2: REFERENCES:

### 2.1. Guidance Drawings/Nameplate Data

- 2.1.1. Drawing Number 47B MLB 320-030 – Window Heaters/Blowers/Wipers
- 2.1.2. Drawing Number 47B MLB 625-010 – Window List
- 2.1.3. Drawing Number 47B MLB 150-010 – DKHSE Side Stbd
- 2.1.4. Drawing Number 47B MLB 150-020 – DKHSE Side Port
- 2.1.5. Drawing Number 47B MLB 150-050 – Enclosed Bridge Top
- 2.1.6. Drawing Number 47B MLB 150-100 – Upper BHD FR 8

### 2.2. Standards

- 2.2.1. See H-1 General Notes.

### 2.3. Regulations

- 2.3.1. See H-1 General Notes

### 2.4. Government Furnished Material

- 2.4.1. N/A

### 2.5. Contractor Furnished Material

- 2.5.1. The Contractor must supply everything that is required to perform the specified work unless otherwise stated, such as but not limited to the following: labour, materials, parts, tools, consumables, equipment, machinery, storage, shelters, staging, rigging, scaffolding, enclosures, power and heating. must
- 2.5.2. Refer to Appendix A for List of Original Suppliers or Appendix B for List of Alternate/Additional Suppliers
- 2.5.3. All supplied and installed equipment must be certified by RO Class or TCMS as required

### **3. PART 3: TECHNICAL DESCRIPTION:**

#### **3.1. General**

- 3.1.1. The Contractor must ensure prior to any work commencing, that both the Contractor Basic Safety Familiarization and Pre Job Safety Assessment are completed and signed off.
- 3.1.2. The Contractor must disconnect the wiring from the heated windows and protect the wiring for reuse.
- 3.1.3. The Contractor must detach the windows and remove the windows from the vessel to secure protected storage.
- 3.1.4. All windows must be inspected on removal for damage. Any damaged windows will be replaced via PSPC 1379 action at the discretion of the TA.
- 3.1.5. The Contractor must remove any gasket material and hand tool clean the landing surfaces to bare aluminium and inspect for cracks and corrosion.
- 3.1.6. The Contractor must verify the wiring for the heated windows. The Technical Authority must be called to witness the test. Any defects found will be dealt with via PSPC 1379 action.
- 3.1.7. The Contractor must supply and install four (4) new heated windows of the same size and design.
- 3.1.8. The Contractor must clean the sealing surfaces of the hinged windows and verify the windows operate freely.
- 3.1.9. The Contractor must inspect all the windows for indication of broken seals. Windows with broken seals will be repaired via PSPC 1379 action.
- 3.1.10. The Contractor must clean the landing surface of all the windows using hand tools to prepare for reinstallation. Upon completion of cleaning the Technical Authority must inspect the windows to determine acceptability for re-installation.
- 3.1.11. The contractor must re-install the windows using new gaskets of the same materials as those removed.
- 3.1.12. The Contractor must reconnect the heating units, verify the operation and present the windows to the Technical Authority for inspection.
- 3.1.13. The Contractor must verify paint work has not been disturbed by the reinstallation and repair any disturbed paint.
- 3.1.14. Upon completion of reinstallation the RO Class Inspector and Technical Authority must inspect the installation. Any defects must be corrected and presented for re-inspection.

#### **3.2. Location**

- 3.2.1. Vessel topside

#### **3.3. Interferences**



- 3.3.1. The Contractor is responsible for the identification of all interference items, their temporary removal, storage, and refitting to the vessel.

**4. PART 4: PROOF OF PERFORMANCE:**

**4.1. Inspection**

- 4.1.1. A visual inspection by the Contractor and TA in attendance, of general workmanship including that of piping, hardware, materials, and coatings must be conducted.
- 4.1.2. It is noted that Canadian Coast Guard will provide the services of an independent NACE Inspector.
- 4.1.3. All work carried out must be verified correct by the Technical Authority and the attending RO Class Inspector or TCMS as required.
- 4.1.4. Refer to Regulations in H-1 General Notes

**4.2. Testing**

- 4.2.1. The Contractor must water test the windows using fresh water from a ½ inch hose at 30 psi. Testing must be witnessed by the Technical Authority. Contractor must correct any leaks and retest the windows until proven leak free.
- 4.2.2. The Contractor must conduct all specified testing and notify the Technical Authority and RO Class Inspector of the schedule for the testing and inspection.
- 4.2.3. The RO Class Inspector and the Technical Authority must witness all specified testing.
- 4.2.4. Wiring must be proven functional and free of grounds.

**4.3. Certification**

- 4.3.1. N/A

**5. PART 5: DELIVERABLES:**

**5.1. Drawings/Reports**

- 5.1.1. The Contractor must produce two (2) electronic PDF copies of a final report for the TA upon completion of the above noted scope of work. The final report must contain the results of all inspections, testing, manufacturer information, part numbers and details of work completed..
- 5.1.2. The Contractor must include all associated documentation related to this specification as described H-1 General Notes - Section 5 - Documentation.

**5.2. Spares**

- 5.2.1. N/A

**5.3. Training**

- 5.3.1. N/A

**5.4. Manuals**

- 5.4.1. The Contractor must include all associated manuals related to this specification as described in H-1 General Notes - Section 7 – Manuals.

	MLB	
Spec Item #: H-11	SPECIFICATION	
REPLACE ENCLOSED BRIDGE LADDER		

## 1. PART 1 - SCOPE

- 1.1. The intent of this specification is for the Contractor to remove the existing ladder in the enclosed wheelhouse, fabricate and install a new ladder.

## 2. PART 2 – REFERENCES

### 2.1. Guidance Drawings/Nameplate Data

- 2.1.1. Drawing Number 47B MLB 110-630 – Enclosed Bridge Arrangement

### 2.2. Standards

- 2.2.1. See General Notes H-1

### 2.3. Regulations

- 2.3.1. See General Notes H-1

### 2.4. Government Furnished Material

- 2.4.1. N/A

### 2.5. Contractor Furnished Material

- 2.5.1. The Contractor must supply everything that is required to perform the specified work unless otherwise stated, such as but not limited to the following: labour, materials, parts, tools, consumables, equipment, machinery, storage, shelters, staging, rigging, scaffolding, enclosures, power and heating. must
- 2.5.2. Refer to Appendix A for List of Original Suppliers or Appendix B for List of Alternate/Additional Suppliers

## 3. PART 3 – TECHNICAL DESCRIPTION

### 3.1. General

- 3.1.1. The Contractor must ensure prior to any work commencing, that both the Contractor Basic Safety Familiarization and Pre Job Safety Assessment are completed and signed off.
- 3.1.2. The Contractor must remove the existing ladder in the enclosed bridge.
- 3.1.3. Ladder must be treated as Class C material.
- 3.1.4. The Contractor must fabricate a ladder using five (5) inch aluminium channel bar for the side rails and rungs, and mount the ladder flush to the bulkhead.
- 3.1.5. This design will take up less deck space, allowing crew to pass in front of the ladder more easily.
- 3.1.6. The Contractor must use 3M non-skid on the rungs of the ladder.

### 3.2. Location

3.2.1. Enclosed bridge

**3.3. Interferences**

3.3.1. The Contractor is responsible for the identification of all interference items, their temporary removal, secure storage, and refitting to the vessel.

**4. PART 4 – PROOF OF PERFORMANCE**

**4.1. Inspection**

4.1.1. A visual inspection by the Contractor and TA in attendance, of general workmanship including that of piping, hardware, materials, and coatings must be conducted.

**4.2. Testing**

4.2.1. N/A

**4.3. Certification**

4.3.1. Refer to Regulations in H-1 General Notes

**5. PART 5 - DELIVERABLES**

**5.1. Drawings/Reports**

5.1.1. The Contractor must produce two (2) electronic PDF copies of a final report for the TA upon completion of the above noted scope of work. The final report must contain the results of all inspections, testing, manufacturer information, part numbers and details of work completed..

5.1.2. The Contractor must include all associated documentation related to this specification as described H-1 General Notes - Section 5 - Documentation.

5.1.3. If any alterations from the original drawings have been made, the Contractor must include revised as fitted drawings as described in H-1 General Notes - Section 6 - Drawings.

**5.2. Spares**

5.2.1. N/A

**5.3. Training**

5.3.1. N/A

**5.4. Manuals**

5.4.1. The Contractor must include all associated manuals related to this specification as described in H-1 General Notes - Section 7 - Manuals.

	MLB	
Spec Item #: H-12	SPECIFICATION	
REFURBISH MAST & BUOYANCY TANK		

### 1. PART 1: SCOPE:

- 1.2. The intent of this specification is to refurbish the mast and buoyancy tank.
- 1.3. The Contractor must provide the services of a Level 2 Certified UT Technician to conduct a minimum of ten (10) UT shots on the buoyancy tank.
- 1.4. This work must be carried out in conjunction with the topside painting, E-106 Refurbish Searchlight and E-103 Replace Navigation Lights.

### 2. PART 2: REFERENCES:

#### 2.1. Guidance Drawings/Nameplate Data

- 2.1.1. Drawing Number 47B MLB 171-010 – Mast
- 2.1.2. Drawing Number 47B MLB 150-030 – Open Bridge Deck
- 2.1.3. Drawing Number 47B MLB 612-010 – Handrails
- 2.1.4. Drawing Number 47B MLB 331-010 – Lights and Switches Installation
- 2.1.5. Drawing Number 47B MLB 405-010 – Antenna Arrangement and Installation

#### 2.2. Standards

- 2.2.1. See H-1 General Notes

#### 2.3. Regulations

- 2.3.1. See H-1 General Notes

#### 2.4. Government Furnished Material

- 2.4.1. N/A

#### 2.5. Contractor Furnished Material

- 2.5.1. The Contractor must supply everything that is required to perform the specified work unless otherwise stated, such as but not limited to the following: labour, materials, parts, tools, consumables, equipment, machinery, storage, shelters, staging, rigging, scaffolding, enclosures, power and heating.
- 2.5.2. All supplied and installed equipment must be certified by RO Class or TCMS as required
- 2.5.3. Refer to Appendix A for List of Original Suppliers or Appendix B for List of Alternate/Additional Suppliers

### 3. PART 3: TECHNICAL DESCRIPTION:

#### 3.1. General

- 3.1.1. The Contractor must ensure prior to any work commencing, that both the Contractor Basic Safety Familiarization and Pre Job Safety Assessment are completed and signed off.
- 3.1.2. The Contractor must disconnect the mast with buoyancy tank from the vessel and transport the tank to a shop for cleaning testing and painting.
- 3.1.3. The Contractor must remove all wiring and equipment from the mast and store in a protected heated environment until ready for reinstallation. Removal of electronic equipment must be overseen by a Contractor supplied marine electronics technician.
- 3.1.4. The Contractor must grit blast the mast and tank to bare metal.
- 3.1.5. The Contractor must provide the services of a Level 2 Certified UT Technician to conduct a minimum of ten (10) UT shots on the buoyancy tank.
- 3.1.6. The Contractor must clean the attachment points for the tank to the mast and following inspection by the RO Class Inspector and Technical Authority the Contractor must recoat these points using the painting scheme and paints used in that portion of the vessel.
- 3.1.7. Upon completion of cleaning the RO Class Inspector and Technical Authority must inspect the tank to determine overall condition.
- 3.1.8. Any repairs indicated necessary during the inspection and testing must be covered as a work arising. Any work arising within this contract due to RO inspection results or additional work not covered by this statement of work will be handled via PSPC 1379 action.
- 3.1.9. On completion of the repairs and testing the tank must be cleaned, dried and repainted using the paint scheme used for the mast and topside of the vessel.
- 3.1.10. The contractor must inspect the mast in the presence of the RO Class Inspector and Technical Authority. Any damage or repairs will be via PSPC 1379 action. Any work arising within this contract as a result of RO inspection will be dealt with 1379 action.
- 3.1.11. The Contractor must paint the mast using the same colour and paint scheme as the top side of the vessel.
- 3.1.12. The Contractor must reassemble the mast, buoyancy tank, all equipment and attachments
- 3.1.13. The Contractor must return the mast with tank to the vessel and reinstall using new bolts, nuts and washers. All fittings must be marine grade stainless steel.
- 3.1.14. Upon completion of reinstallation the RO Class Inspector and Technical Authority must inspect the installation. Any defects must be corrected and presented for re-inspection.

### **3.2. Location**

- 3.2.1. Vessel topside

### **3.3. Interferences**

- 3.3.1. The Contractor is responsible for the identification of all interference items, their temporary removal, storage, and refitting to the vessel.

#### **4. PART 4: PROOF OF PERFORMANCE:**

##### **4.1. Inspection**

- 4.1.1. The Coast Guard will be retaining the services of a NACE Inspector.
- 4.1.2. All work carried out must be verified correct and approved by the Technical Authority and the attending RO Class Inspector or TCMS as required
- 4.1.3. Refer to Regulations in H-1 General Notes

##### **4.2. Testing**

- 4.2.1. The Contractor must water test the tank to two (2) PSI and hold the test for one (1) hour while checking for leaks. On completion of the one (1) hour test the contractor must present the tank under pressure to the RO Class Inspector and Technical Authority.
- 4.2.2. The Contractor must conduct a high potential voltage test, in accordance with TP127, all wiring to ensure they are free from grounds. The Contractor must use the services of the Contractor supplied marine electronics technician to ensure the protection of the electronic equipment.
- 4.2.3. The Contractor must conduct all specified testing and notify the Technical Authority and RO Class Inspector of the schedule for the testing and inspection.
- 4.2.4. The RO Class Inspector and the Technical Authority must witness all specified testing.
- 4.2.5. NDT testing of any welds as per CCG Welding Specification CT-043-eg-eq-001

##### **4.3. Certification**

- 4.3.1. N/A

#### **5. PART 5: DELIVERABLES:**

##### **5.1. Drawings/Reports**

- 5.1.1. The Contractor must produce two (2) electronic PDF copies of a final report for the TA upon completion of the above noted scope of work. The final report must contain the results of all inspections, testing, manufacturer information, part numbers and details of work completed..
- 5.1.2. The Contractor must include all associated documentation related to this specification as described H-1 General Notes - Section 5 - Documentation.

##### **5.2. Spares**

- 5.2.1. N/A

##### **5.3. Training**

5.3.1. N/A

**5.4. Manuals**

5.4.1. N/A



	MLB	
Spec Item #: H-13	SPECIFICATION	
<b>REPLACE BILGE OVERBOARD PIPING</b>		

## 1. PART 1: SCOPE

- 1.1. The intent of this specification is to replace existing schedule 40 bilge piping between the check valve and the through hull with new schedule 80 pipe, threaded at the inboard end to mate with a new check valve of the same make and original design.
- 1.2. This work must be carried out in conjunction with the following specification items:
- a) H-14 Replace Through Hull Connections

## 2. PART 2: REFERENCES:

### 2.1. Guidance Drawings/Nameplate Data

- 2.1.1. Drawing Number 47B MLB 529-001 - Diagrammatic Bilge System
- 2.1.2. Drawing Number 47B MLB 201-010 – Machinery Arrangement
- 2.1.3. Drawing Number 47B MLB 505-023 – Piping in Hull, Bilge System
- 2.1.4. Drawing Number 47B MLB 521-010 – Dewatering Pump Arrangement and Details
- 2.1.5. Drawing Number 47B MLB 436-015 – Bilge Alarm System

### 2.2. Standards

- 2.2.1. See General Notes H-1

### 2.3. Regulations

- 2.3.1. See General Notes H-1

### 2.4. Government Furnished Material

- 2.4.1. N/A

### 2.5. Contractor Furnished Material

- 2.5.1. The Contractor must supply everything that is required to perform the specified work unless otherwise stated, such as but not limited to the following: labour, materials, parts, tools, consumables, equipment, machinery, storage, shelters, staging, rigging, scaffolding, enclosures, power and heating. .
- 2.5.2. Refer to Appendix A for List of Original Suppliers or Appendix B for List of Alternate/Additional Suppliers.
- 2.5.3. All supplied and installed equipment must be certified by RO Class or TCMS as required

### **3. PART 3: TECHNICAL DESCRIPTION**

#### **3.1. General**

- 3.1.1. The vessels are fitted with five (5) pumps and discharge valves in different spaces on the vessel. Existing piping is screw fitted aluminum schedule “40”, 1 ¼”. New schedule “80 1 ¼” piping must be installed between the check valves and the through hull fittings.
- 3.1.2. The through hull connections must be replaced as part of H-24 Replace Through Hull Connections.
- 3.1.3. The Contractor must remove the existing piping from the outboard side of the check valves to the hull.
- 3.1.4. The check valves must also be removed and replaced with new.
- 3.1.5. The Contractor must examine the existing piping from the discharge side of the bilge pumps to the check valve. Any deficiencies will be treated as work arising, via PSPC 1379 action.
- 3.1.6. The Contractor must supply and install new schedule 80 piping from each through hull to each check valve. Revised piping must be routed and function in accordance with original drawings (schedule 80 pipe being the exception).
- 3.1.7. The pipe must be threaded on the inboard side to mate with the new check valve and existing bilge pump piping arrangement.
- 3.1.8. The Contractor must install the piping following the same route as the existing piping using existing pipe hangers.
- 3.1.9. All fixed portions of pipe hangers and supports must be retained as found.
- 3.1.10. Contractor must treat all removals as Class C material.

#### **3.2. Installation**

- 3.2.1. The Contractor must install new material as per original system arrangement and in accordance with original system drawings.
- 3.2.2. All piping, valves, penetrations, and other fittings must be as defined on original drawings and Class approved for application (excepting requirement for schedule 80 pipe). If any discrepancy between drawings and Class approval requirements Class approval must take precedent.
- 3.2.3. The Contractor is responsible for cleaning any debris, touching up any disturbed coatings and presenting the completed work to the TA.

#### **3.3. Interference**

- 3.3.1. The contractor must remove and store any interference items and reinstall on completion of the work.

### **4. PART 4: PROOF OF PERFORMANCE**

#### **4.1. Inspection**

4.1.1. All work must be inspected by the Technical Authority and ABS Class Surveyor. The acceptance criteria must be that the completed work meets the specification, Transport Canada and ABS requirements and is free of leaks.

4.1.2. Refer to Regulations in H-1 General Notes

#### **4.2. Testing**

4.2.1. All bilge pumps must be tested in accordance with manufacturer's instructions.

4.2.2. All bilge alarms must be tested in accordance with manufacturer's instructions.

4.2.3. The Contractor must demonstrate correct function of each system.

### **5. PART 5: DELIVERABLES**

#### **5.1. Drawings/Reports**

5.1.1. The Contractor must provide complete Bill of Materials for new piping systems and OEM specification, parts and instruction information for all parts used where applicable.

5.1.2. The Contractor must produce two (2) electronic PDF copies of a final report for the TA upon completion of the above noted scope of work. The final report must contain the results of all inspections, testing, manufacturer information, part numbers and details of work completed..

5.1.3. The Contractor must include all associated documentation related to this specification as described H-1 General Notes - Section 5 – Documentation.

5.1.4. If any alterations from the original drawings have been made, the Contractor must include revised as fitted drawings as described in H-1 General Notes - Section 6 - Drawings.

#### **5.2. Spares**

5.2.1. N/A

#### **5.3. Training**

5.3.1. N/A.

#### **5.4. Manuals**

5.4.1. The Contractor must include all associated manuals related to this specification as described in H-1 General Notes - Section 7 - Manuals.

#### **5.5. Certification**

5.5.1. The Contractor must provide Class acceptance documents for installed system and all applicable system components.

	MLB	
Spec Item #: H-14	SPECIFICATION	
<b>THROUGH HULL CONNECTIONS</b>		

### 1. PART 1: SCOPE:

- 1.2. The scope of this specification is to remove all components of the existing through hull connections and must install new through hull fittings and valves with materials as per original arrangement and function in accordance with original drawings.
- 1.3. Work must be done in conjunction with H-23 Replace Seawater Piping and H-13 Replace Bilge Overboard Piping.

### 2. PART 2: REFERENCES:

#### 2.1. Guidance Drawings/Nameplate Data

- 2.1.1. Drawing Number 47B MLB 505-022 – Piping, Hull (Sea Water Cooling)
- 2.1.2. Drawing Number 47B MLB 505-023 – Piping, Hull (Bilge System)
- 2.1.3. Drawing Number 47B MLB 505-040 – Piping, Hull (Fire pump, hand operated)
- 2.1.4. Drawing Number 47B MLB 521-010 – Dewatering Pump Arrangement

#### 2.2. Standards

- 2.2.1. See H-1 General Notes

#### 2.3. Regulations

- 2.3.1. See H-1 General Notes

#### 2.4. Government Furnished Material

- 2.4.1. N/A

#### 2.5. Contractor Furnished Material

- 2.5.1. The Contractor must supply everything that is required to perform the specified work unless otherwise stated, such as but not limited to the following: labour, materials, parts, tools, consumables, equipment, machinery, storage, shelters, staging, rigging, scaffolding, enclosures, power and heating.
- 2.5.2. Through hull connections must have certification
- 2.5.3. All supplied and installed equipment must be certified by RO Class or TCMS as required.
- 2.5.4. Refer to Appendix A for List of Original Suppliers or Appendix B for List of Alternate/Additional Suppliers.

### 3. PART 3: TECHNICAL DESCRIPTION:

#### 3.1. General

- 3.1.1. The Contractor must remove all components of the existing through hull connections and must install new through hull fittings and valves with materials as per original arrangement and function in accordance with original drawings.

### **3.2. Removals**

- 3.2.1. The Contractor must remove all through hull fittings and valve materials from installed locations and remove from vessel.
- 3.2.2. Scope of removal must be from the outer hull, to and including, the inboard flange of the sea valves.
- 3.2.3. All associated valves must be included as removals.
- 3.2.4. All fixed portions of pipe hangers and supports must be retained as found.
- 3.2.5. The Contractor must treat all removals as Class C material.

### **3.3. Installation**

- 3.3.1. The Contractor must install new material as per original system arrangement and in accordance with original system drawings.
- 3.3.2. All piping, valves, penetrations, and other fittings must be as defined on original drawings and Class approved for application. If any discrepancy between drawings and Class approval requirements Class approval must take precedent.

### **3.4. Interference**

- 3.4.1. The Contractor must remove and store any interference items and reinstall on completion of the work.

## **4. PART 4: PROOF OF PERFORMANCE:**

### **4.1. Inspection**

- 4.1.1. All work carried out must be verified correct by the Technical Authority and the attending RO Class Inspector or TCMS as required
- 4.1.2. A visual inspection by the Contractor and TA in attendance, of general workmanship including that of piping, hardware, materials, and coatings must be conducted.

### **4.2. Testing**

- 4.2.1. The Contractor must pressure test completed work to ensure watertight integrity.
- 4.2.2. NDT testing of any welds as per CCG Welding Specification CT-043-eg-eq-001

### **4.3. Trials**

- 4.3.1. Trial must be carried out in conjunction with test of H-33 Replace Seawater Piping and M-75 Replace Bilge Overboard Pipes and Check Valves
- 4.3.2.

## **5. PART 5: DELIVERABLES:**

**5.1. Drawings/Reports**

- 5.1.1. The Contractor must provide a complete Bill of Materials for new valves and OEM specification, parts and instruction information for all parts used where applicable.
- 5.1.2. The Contractor must produce two (2) electronic PDF copies of a final report for the TA upon completion of the above noted scope of work. The final report must contain the results of all inspections, testing, manufacturer information, part numbers and details of work completed..
- 5.1.3. The Contractor must include all associated documentation related to this specification as described H-1 General Notes - Section 5 - Documentation.

**5.2. Spares**

- 5.2.1. N/A

**5.3. Training**

- 5.3.1. N/A.

**5.4. Manuals**

- 5.4.1. N/A

**5.5. Certification**

- 5.5.1. The Contractor must provide Class acceptance documents for installed system and all applicable system components.

	MLB	
Spec Item #: H-15	SPECIFICATION	
REPLACE STERN TUBES		

## 1. PART 1 - SCOPE

- 1.1. This specification covers work must be completed onboard the CCG 47' Motor Lifeboats to replace the heavily pitted, port and starboard side shaft stern tubes. The specification outlines the extent of work must be completed to prepare the area for the removal and replacement of the stern tubes and affected structure.

## 2. PART 2 – REFERENCES

### 2.1. Guidance Drawings/Nameplate Data

- 2.1.1. J20031-S01 CCG 47ft Motor Lifeboats Stern Tube Replacement Details

### 2.2. Standards

- 2.2.1. CSA W47.2-11, Certification of Companies for the Fusion Welding of Aluminum
- 2.2.2. CSA W59.2, Welded Aluminum Construction
- 2.2.3. CSA Standard 178.2-18, Certification of Welding Inspectors
- 2.2.4. CAN/CGSB Standard 48.98712-2012, Non-destructive Testing - Qualification and Certification of NDT personnel
- 2.2.5. IACS No. 47 - Shipbuilding and Repair Quality Standard (1996) Part B - Repair Quality Standard for Existing Ships.

Note: In case of conflict between any of the standards, then the most stringent requirements must prevail.

### 2.3. Regulations

- 2.3.1. Canada Shipping Act - Hull Construction Regulations
- 2.3.2. Canada Shipping Act - Hull Inspection Regulations
- 2.3.3. Canada Shipping Act - Safe Working Practices Regulations
- 2.3.4. MOSHR, Canada Labour Code - Marine Occupational Safety and Health Regulations

### 2.4. Government Furnished Material

- 2.4.1. N/A

### 2.5. Contractor Furnished Material

- 2.5.1. The Contractor must supply everything that is required to perform the specified work unless otherwise stated, such as but not limited to the following: labour, materials, parts, tools, consumables, equipment, machinery, storage, shelters, staging, rigging, scaffolding, enclosures, power and heating. . See also applicable structural guidance drawings for material requirements.
- 2.5.2. In preparation for new structural repair work, the Contractor must provide all ancillary services necessary to complete the subject modifications. These may include, but are not limited to strip out, temporary removal of interference items, staging, cleaning, debris removal, water, shore power, etc.
- 2.5.3. Belzona 1341 (Supermetalgilde) coatings are required must be supplied by the contractor.
- 2.5.4. Four (4) Johnson Cutless Non-Metallic Sleeve Bearings – commonly referred to as a ‘Josie’ bearing – suited for a 2 1/2” diameter shaft

### **3. PART 3 – TECHNICAL DESCRIPTION**

#### **3.1. General**

- 3.1.1. All new aluminum plate must be 5456-H116 and new shapes or extrusions must be 5456-H111 or equivalent. New aluminum tubing for stern tubes must be 5086-H32. Mill certificates must be provided for all materials installed and must be approved by the Technical Authority and/or the delegated ABS (DSIP) inspector for use.
- 3.1.2. All work must be consistent with good shipbuilding practice where standards are not applicable. The work must be conducted to the satisfaction of the Project Technical Authority and/or the delegated ABS (DSIP) inspector.
- 3.1.3. New aluminium material required must be stored by the Contractor in a dry, climate-controlled environment completely separate from any other material.
- 3.1.4. The Contractor must ensure that any contact between aluminium and any other metal component must be electrically isolated.
- 3.1.5. The existing stern tubes (P&S) must be removed from the bottom hull structure and the bulkhead at frame 5 in their entirety and discarded. A section of the bottom shell plating in way of the stern tubes must also be removed, along with a partial removal of the transverse bottom stiffening at frame 4 and 4.25” aft of frame 4, between shell longitudinals #3 and #4. A section of bulkhead plating at frame 5 must be removed in conjunction with the stern tube removal. The full extent of the required structural removals must must be as indicated on the guidance drawing J20031-S01.
- 3.1.6. Provide all appropriate permits for entrance into and completion of welding in confined spaces if required.



- 3.1.7. During the completion of hot work, the Contractor must supply fire watch while hot work is ongoing, with appropriate class portable fire extinguisher and charged fire hose ready for use.
- 3.1.8. Coordinate subject work inspection with Technical Authority and the delegated ABS (DSIP) inspector.
- 3.1.9. Following the completion of hot work in specific areas of the vessel, the Contractor must clean affected spaces and remove debris from vessel.
- 3.1.10. The Contractor must clean and apply primer, as applicable, to welded seams and other disturbed areas.
- 3.1.11. The Contractor must reinstate all disturbed outfitting, equipment, cables, pipes/hoses, coatings, fixtures etc. as per original. Where any items were damaged during the removal process, they must be replaced by the Contractor as per the original arrangement.
- 3.1.12. A new 5/16" thick shell insert plate must be installed, along with new partial transverse frames at frame 4 and 4.25" aft of frame 4 (P&S). New 3/16" thick insert plates must be installed in the bulkhead at frame 5 (P&S). New stern tubes (4" O.D. x 1/2" wall) must be fabricated and installed (P&S) within the new bottom hull structure and bulkhead at frame 5 and must be aligned with the existing shaft lines of the vessel. The new stern tubes must have their after ends machined to accept new shaft bearings. Holes must be drilled and tapped to accept set screws for the new bearings.
- 3.1.13. Final alignment of the new stern tubes must be in accordance with standard shaft line installation procedures. Contractor must provide alignment plan to the Technical Authority and/or the delegated ABS (DSIP) inspector for approval.
- 3.1.14. The full extent of the new structural details must be as indicated on the guidance drawing J20031-S01.
- 3.1.15. All aluminium welding must be performed in a permanent, heated and environmentally controlled facility that isolates the process from any form of contamination. All welding must be in accordance with the applicable section of the latest ABS Rules for aluminum vessels.
- 3.1.16. Welding of aluminum must not be carried out at a temperature lower than +5 degrees Celsius. Weld preparation and cleaning must be conducted immediately prior to welding.
- 3.1.17. Delays in aluminum welding following preparation and cleaning must necessitate the preparation and cleaning must be conducted again. The Contractor must define the

environmental limits (e.g. maximum humidity levels) at which welding can be performed and still meet quality requirements.

- 3.1.18. All new and disturbed aluminum work that is intended must be painted must be painted in accordance with the existing paint scheme of the vessel and the applicable Canadian Coast Guard Paint Specification. Preparation and application of coatings must be in accordance with the manufacturer's instructions.
- 3.1.19. Disturbed and/or new aluminum surfaces must have all burrs, sharp edges, rough areas, and weld splatter removed using industry recognised methods for aluminum.
- 3.1.20. Power tool clean aluminum areas that must be painted using a fine grinding pad or rotary flapper.
- 3.1.21. Feather back the intact coatings on existing structure a minimum of 50mm from the area must be painted.
- 3.1.22. Remove by solvent cleaning all welding slag, oil, grease, and salts.
- 3.1.23. Unless specified otherwise, disturbed and/or new aluminum work intended must be painted must be given a minimum of two (2) coats of marine primer immediately upon completion of work.
- 3.1.24. CCG requires that the internal surfaces of the new stern tubes must be suitably coated to prevent a recurrence of the pitting issues experienced with the existing stern tubes. The recommended coating is Belzona 1341 (Supermetalglide).
- 3.1.25. Lead-based paints must not be used.
- 3.1.26. New stern tube bearings must be supplied and installed at after end of the new stern tubes. Bearings must be water lubricated and must be the same make/model as the existing (Johnson Cutless Non-Metallic Sleeve Bearings – 'Josie' – suited for a 2 1/2" diameter shaft). These bearings must be installed as per the manufacturer's installation guidelines.
- 3.1.27. New shaft seals must be installed after final installation of the new stern tubes, hull structure and re-alignment of the existing shafts (P&S). Existing shaft seal water supply/air vent connection(s) must be reconnected after reinstallation of shaft seals.
- 3.1.28. When all the new structural repair work is completed, the Contractor must assume responsibility for restoring the area to the condition it was in before the work commenced.
- 3.1.29. The Contractor must reinstate all equipment, pipes/hoses, fixtures, cabling, etc. that had must be removed and/or temporarily relocated as per original. Where any items were damaged during the removal process, they must be replaced by the Contractor as per the original arrangement.

## **3.2. Location**

3.2.1. Stern of vessel, hull, engine room, survivors compartment

### **3.3. Interferences**

3.3.1. The Contractor must remove and/or protect fittings, fixtures, cables, pipes/hoses, machinery, etc. as required to complete hot work.

3.3.2. In those areas that are disturbed by the proposed work, the Contractor is responsible for identifying the locations and ensuring that all existing materials such as piping, hoses, cables etc. are removed or pulled back temporarily and the area made clear and safe for the work to proceed.

3.3.3. In order to provide access the existing stern tubes and bottom shell structure for removals, and subsequently for the installation of the new stern tubes, several items within the engine room will need must be temporarily relocated, disconnected and/or removed in their entirety to make way for the required work. These must include, but are not limited to:

- Main engines
- Propellers, propeller shafting and shaft seals
- Cardan shafts (w/ bulkhead seal)
- Silencers
- Exhaust piping/supports between engines and silencers
- 'North Sea' cross-connecting exhaust piping and supports
- Fuel filter/water separators and connected fuel piping and hoses
- Cooling water connections to engines

3.3.4. If required, the Contractor is responsible for tagging any items temporarily removed for the required structural removals and the installation of the new structural items. The Contractor must protect and store items in a heated, cleaned and dry environment.

3.3.5. When the work is completed, the Contractor must assume responsibility for restoring the area to the same condition it was in before the work commenced. Additional care must be taken to ensure that the areas in question are in no danger of fire risk while any hot work is undertaken.

## **4. PART 4 – PROOF OF PERFORMANCE**

### **4.1. Inspection**

4.1.1. Inspections must be carried out by the Technical Authority and the delegated ABS (DSIP) inspector. They must conduct a final inspection to determine acceptance of the work. The work must also be inspected by the Contractor to ensure the methods of installation and workmanship conform to the drawings and specification.

- 4.1.2. A physical inspection of all welding of new structure and repairs must be carried out by the Contractor to ensure that all welds are satisfactory and contain no visible defects or deficiencies. In addition to 100% visual inspection, welded joints must be examined using 100% x-ray for butt welds and/or corners and cruciform or as otherwise agreed with delegated ABS (DSIP) inspector. Weld inspections must be performed by a third party certified welding inspector provided by the Contractor.
- 4.1.3. Non-destructive examinations of welds must be undertaken by professional personnel qualified to do so. All visual results and readings must be tabulated, compiled and two typewritten bound copies must be provided to the Technical Authority with workers original handwritten notes.
- 4.1.4. The full extent of any weld defect must be ascertained by applying additional non-destructive examinations where required. Unacceptable defects must be completely removed and where necessary, re-welded. The repair must be examined after re-welding.

#### **4.2. Testing**

- 4.2.1. Any equipment, electrical system, piping system, etc. that had must be temporarily moved/removed or disconnected to facilitate the structural repair work must be tested after the structural work has been completed to ensure that it is operational in accordance with its intended use.

#### **4.3. Certification**

- 4.3.1. Mill certificates must be provided to the TA for all materials installed.

### **5. PART 5 – DELIVERABLES**

#### **5.1. Drawings/Reports**

- 5.1.1. The Contractor must produce two (2) electronic PDF copies of a final report for the TA upon completion of the above noted scope of work. The final report must contain the results of all inspections, testing, manufacturer information, part numbers and details of work completed..
- 5.1.2. The Contractor must include all associated documentation related to this specification as described H-1 General Notes - Section 5 - Documentation
- 5.1.3. The Contractor must provide new As-Fitted Drawings as per H-1 General Notes Section 6 Drawings

#### **5.2. Spares**

- 5.2.1. N/A

#### **5.3. Training**

- 5.3.1. N/A

**5.4. Manuals**

- 5.4.1. The Contractor must include all associated manuals related to this specification as described in H-1 General Notes - Section 7 - Manuals.

	MLB	
Spec Item #: H-16	SPECIFICATION	
REFURBISH HAND RAILINGS		

### 1. PART 1: SCOPE:

- 1.1. The intent of this spec is to sandblast and clean hand rails and D rings to bare aluminum, inspect repair and recoat.
- 1.2. Work must be done in conjunction with topside painting in H-9.

### 2. PART 2: REFERENCES:

#### 2.1. Guidance Drawings/Nameplate Data

- 2.1.1. Drawing Number 47B MLB 612-010 - Handrails

#### 2.2. Standards

- 2.2.1. See General Notes H-1

#### 2.3. Regulations

- 2.3.1. See General Notes H-1

#### 2.4. Government Furnished Material

- 2.4.1. N/A

#### 2.5. Contractor Furnished Material

- 2.5.1. The Contractor must supply everything that is required to perform the specified work unless otherwise stated, such as but not limited to the following: labour, materials, parts, tools, consumables, equipment, machinery, storage, shelters, staging, rigging, scaffolding, enclosures, power and heating. .
- 2.5.2. Refer to Appendix A for List of Original Suppliers or Appendix B for List of Alternate/Additional Suppliers.

### 3. PART 3: TECHNICAL DESCRIPTION:

#### 3.1. General

- 3.1.1. The Contractor must ensure prior to any work commencing, that both the Contractor Basic Safety Familiarization and Pre Job Safety Assessment are completed and signed off.
- 3.1.2. The Contractor must sandblast the handrails and 34 D rings to bare metal.
- 3.1.3. The Contractor must examine the hand rails and D rings to determine if any cracks or Defects exists.
- 3.1.4. The Contractor must present the bare cleaned rails and rings prior to painting must be inspected by the Technical Authority.

3.1.5. The Contractor must remove all grit or debris from the area prior to any painting application.

3.1.6. The Contractor must paint and preserve the rails and rings using the same painting scheme and materials as the surrounding area.

**3.2. Location**

3.2.1. Exterior decks.

**3.3. Interferences**

3.3.1. The Contractor is responsible for the identification of all interference items, their temporary removal, secure storage, and refitting to the vessel.

**4. PART 4: PROOF OF PERFORMANCE:**

**4.1. Inspection**

4.1.1. All work carried out must be verified correct by the Technical Authority and the attending RO Class Inspector or TCMS as required

4.1.2. A visual inspection by the Contractor and TA in attendance, of general workmanship including that of piping, hardware, materials, and coatings must be conducted.

4.1.3. All exposed aluminum on completion of sand blasting must be 100% visually inspected.

4.1.4. The Contractor must examine all welds using dye penetrant and present their findings to the TA.

**4.2. Testing**

4.2.1. Welds must be tested using dye penetrant; Repairs will be treated as additional work and processed via PSPC 1379 action.

4.2.2. A sample of 5 D rings selected by the Technical Authority must be subjected to a proof load of 200 KGs

**4.3. Certification**

4.3.1. N/A

**5. PART 5: DELIVERABLES:**

**5.1. Drawings/Reports**

5.1.1. The Contractor must produce two (2) electronic PDF copies of a final report for the TA upon completion of the above noted scope of work. The final report must contain the results of all inspections, testing, manufacturer information, part numbers and details of work completed..

5.1.2. Contractor must include all associated documentation related to this specification as described H-1 General Notes - Section 5 - Documentation.

**5.2. Spares**

5.2.1. N/A

**5.3. Training**

5.3.1. N/A

**5.4. Manuals**

5.4.1. N/A



	MLB	
Spec Item #: H-17	SPECIFICATION	
<b>REPAIR INSULATION IN ENGINE ROOM &amp; SURVIVOR SPACE</b>		

### **1. PART 1: SCOPE:**

- 1.1. The intent of this spec is to repair the existing insulation in the engine room and the survivor space.
- 1.2. The Contractor must remove and install new insulation of the same make and quality up to a surface area of two (2) square meters.
- 1.3. This work must be carried out in conjunction with the engine replacement work, and deck replacement in the survivor space.

### **2. PART 2: REFERENCES:**

#### **2.1. Guidance Drawings/Nameplate Data**

- 2.1.1. Drawing Number 47B MLB 635-010 – Hull Insulation

#### **2.2. Standards**

- 2.2.1. See General Notes H-1

#### **2.3. Regulations**

- 2.3.1. See General Notes H-1

#### **2.4. Government Furnished Material**

- 2.4.1. N/A

#### **2.5. Contractor Furnished Material**

- 2.5.1. The Contractor must supply everything that is required to perform the specified work unless otherwise stated, such as but not limited to the following: labour, materials, parts, tools, consumables, equipment, machinery, storage, shelters, staging, rigging, scaffolding, enclosures, power and heating. must.
- 2.5.2. Refer to Appendix A for List of Original Suppliers or Appendix B for List of Alternate/Additional Suppliers.
- 2.5.3. All supplied and installed equipment must be certified by RO Class or TCMS as required.

### **3. PART 3: TECHNICAL DESCRIPTION:**

#### **3.1. General**

- 3.1.1. The Contractor must ensure prior to any work commencing, that both the Contractor Basic Safety Familiarization and Pre Job Safety Assessment are completed and signed off.

- 3.1.2. The Contractor must quote on the removal and installation of new insulation of the same make and quality up to a surface area of two (2) square meters.
- 3.1.3. Actual locations of removal/repair of insulation must be agreed upon with the Technical Authority.
- 3.1.4. Any repairs greater than the quoted two (2) square meters will be completed by 1379.
- 3.1.5. The Contractor must remove and dispose of the damaged areas of the existing insulation and dispose of the waste in respects with all environmental regulations in the geographical area.
- 3.1.6. The Contractor must wash the entire exposed area on completion of the removal of the insulation and debris.
- 3.1.7. The Contractor must hand dry the area.
- 3.1.8. The Contractor must install new insulation securing pins to meet the requirements of the insulation manufacturer's instructions.
- 3.1.9. Contractor must install new hard surface insulation of the same manufacture as currently fitted.
- 3.1.10. All insulation must be contractor supplied via 1379.
- 3.1.11. The Contractor must paint the entire surface of insulation in accordance with the vessel painting scheme.

### **3.2. Location**

- 3.2.1. Engine room and Survivor spaces

### **3.3. Interferences**

- 3.3.1. The Contractor is responsible for the identification of all interference items, their temporary removal, storage, and refitting to the vessel.

## **4. PART 4: PROOF OF PERFORMANCE:**

### **4.1. Inspection**

- 4.1.1. A visual inspection by the Contractor and TA in attendance, of general workmanship including that of piping, hardware, materials, and coatings must be conducted.
- 4.1.2. All work must be carried out must be verified correct by both the Technical Authority.

### **4.2. Testing**

- 4.2.1. N/A

### **4.3. Certification**

- 4.3.1. N/A

## **5. PART 5: DELIVERABLES:**

**5.1. Drawings/Reports**

- 5.1.1. The Contractor must produce two (2) electronic PDF copies of a final report for the TA upon completion of the above noted scope of work. The final report must contain the results of all inspections, testing, manufacturer information, part numbers and details of work completed..
- 5.1.2. The Contractor must include all associated documentation related to this specification as described H-1 General Notes - Section 5 – Documentation.
- 5.1.3. Copy of the manufactures MSDS for the coating being applied must be supplied to the Technical Authority.

**5.2. Spares**

- 5.2.1. N/A

**5.3. Training**

- 5.3.1. N/A

**5.4. Manuals**

- 5.4.1. N/A

	MLB	
Spec Item #: H-18	SPECIFICATION	
HULL DOCKING		

## 1. PART 1 - SCOPE

- 1.1. The intent of this specification must be for the contractor to dry dock the vessel in its facility.
- 1.2. The vessel must be docked and undocked with the necessary days required to carry out the specified work with a time allowance to deal with any new work arising, as determined by PSPC.
- 1.3. The vessel while docked must be contained in a weather tight enclosure. Enclosure must be maintained at a minimum of 10 degrees Celsius and allow access for the conduct of work and access by workers.
- 1.4. The vessel must be supplied with 110 Volt, 100 Amp, single phase AC power for the duration of the docking at the Contractor's expense.

## 2. PART 2 – REFERENCES

### 2.1. Guidance Drawings/Nameplate Data

- 2.1.1. Drawing Number 47B MLB 691-010 – Hull Cradle

### 2.2. Standards

- 2.2.1. See General Notes H-1

### 2.3. Regulations

- 2.3.1. See General Notes H-1

### 2.4. Government Furnished Material

- 2.4.1. N/A

### 2.5. Contractor Furnished Material

- 2.5.1. The Contractor must supply everything that is required to perform the specified work unless otherwise stated, such as but not limited to the following: labour, materials, parts, tools, consumables, equipment, machinery, storage, shelters, staging, rigging, scaffolding, enclosures, power and heating. must
- 2.5.2. Refer to Appendix A for List of Original Suppliers or Appendix B for List of Alternate/Additional Suppliers

## 3. PART 3 – TECHNICAL DESCRIPTION

### 3.1. General

- 3.1.1. Docking must be undertaken during the first week of the contract period. If necessary, the Contractor must prepare the dock in advance of the ship's arrival and the official start of the contract.
- 3.1.2. The vessel must be docked for the entire period of the contract period in such a way that must not interfere with its scheduled refloating.
- 3.1.3. A Guidance Docking Plan is available on board the vessel and will be provided to the successful contractor. The Contractor is responsible to ensure drawing is returned to the vessel upon completion of work.
- 3.1.4. The Contractor to prepare blocks and necessary shoring to maintain true alignment of the vessel's hull and machinery throughout the dry-docking period. The Contractor to dock and undock vessel and allow sufficient lay days to complete both the work described in this specification as well as a margin of time to cover work arising. The Contractor must include unit cost/lay day for adjustment.
- 3.1.5. The vessel must be docked so that all docking plugs, transducers, anodes and sea inlet grids are clear and accessible. A minimum clearance of 1.22 meters (4') must be available below the keel. If any hull fittings are covered, the Contractor is responsible for all labour and materials required for making alternative arrangements to drain tanks or move blocks to gain access to areas of specified work. Care must be taken that blocks are set under frames and not between. Any damage as a result of blocks not set properly is the responsibility of the contractor and must be repaired back to original. The docking arrangement must accommodate the removal and re-installation of the rudders.
- 3.1.6. Within two (2) hours of docking, the underwater hull must be cleaned by high-pressure fresh water washing to remove all marine growth and allow preliminary inspection. The hull above the water line is also must be water blasted clean at this time.
- 3.1.7. The Contractor is responsible to remove or relocate any items (spare tail shafts, propellers, etc.) stored on deck, prior to docking or undocking, that will aid in obtaining the required draft and trim for settling on the docking blocks. All items must be secured in original locations after vessel has been undocked.
- 3.1.8. Frame spacing must be marked on the hull as to aid in the initial hull survey by the Technical Authority and or RO Class Surveyor. Immediately after hydro-blasting, but prior to any grit blasting for the underwater hull coating, the Contractor must mark the frame spacing at 5 frame intervals from the stern post (Fr"0"); markings must be in a contrasting colour, approx. 6" in height, and must be at the turn of the bilge, port and stbd.
- 3.1.9. All underwater valves must be shut prior to undocking and checked for water-tightness during the undocking period by the contractor.

- 3.1.10. Prior to flooding the dock the contractor must re-check the security of keel/bilge blocks and docking plugs in the presence of the TA. The condition of the vessel must be the same at undocking as at the time of docking.

**3.2. Location**

- 3.2.1. N/A

**3.3. Interferences**

- 3.3.1. The Contractor is responsible for the identification of interference items, their temporary removal, storage, and refitting to vessel.

**4. PART 4 – PROOF OF PERFORMANCE**

**4.1. Inspection**

- 4.1.1. A visual inspection by the Contractor and TA in attendance, of general workmanship including that of piping, hardware, materials, and coatings must be conducted.
- 4.1.2. All work carried out must be verified correct by the Technical Authority and the attending RO Class Inspector or TCMS as required

**4.2. Testing**

- 4.2.1. N/A

**4.3. Certification**

- 4.3.1. N/A

**5. PART 5 -DELIVERABLES**

**5.1. Drawings/Reports**

- 5.1.1. The Contractor must produce two (2) electronic PDF copies of a final report for the TA upon completion of the above noted scope of work. The final report must contain the results of all inspections, testing, manufacturer information, part numbers and details of work completed..
- 5.1.2. The Contractor must include all associated documentation related to this specification as described H-1 General Notes - Section 5 - Documentation.

**5.2. Spares**

- 5.2.1. N/A

**5.3. Training**

- 5.3.1. N/A

**5.4. Manuals**

- 5.4.1. N/A

	MLB	
Spec Item #: H-19	SPECIFICATION	
OVERHAUL SEA STRAINERS		

## 1. PART 1 - SCOPE

- 1.1. The scope of this spec is to remove the two (2) (port and starboard) duplex Groco seawater strainers from the vessel and completely overhaul.

## 2. PART 2 – REFERENCES

### 2.1. Guidance Drawings/Nameplate Data

- 2.1.1. Drawing Number 47B MLB 505-022 – Piping, Hull (Sea Water Cooling)

### 2.2. Standards

- 2.2.1. See General Notes H-1

### 2.3. Regulations

- 2.3.1. See General Notes H-1

### 2.4. Government Furnished Material

- 2.4.1. N/A

### 2.5. Contractor Furnished Material

- 2.5.1. The Contractor must supply everything that is required to perform the specified work unless otherwise stated, such as but not limited to the following: labour, materials, parts, tools, consumables, equipment, machinery, storage, shelters, staging, rigging, scaffolding, enclosures, power and heating. must
- 2.5.2. Refer to Appendix A for List of Original Suppliers or Appendix B for List of Alternate/Additional Suppliers.

## 3. PART 3 – TECHNICAL DESCRIPTION

### 3.1. General

- 3.1.1. The Contractor must disconnect the Groco duplex sea suction strainers and remove them from the vessel.
- 3.1.2. The Contractor must disassemble to its base components, clean and inspect the duplex strainer for damage. Any damage found will be repaired via PSPC 1379 action.
- 3.1.3. The Contractor must provide and install a rebuild kit for the Groco duplex sea strainer, including but not limited to new o-rings and seals.
- 3.1.4. The Contractor must reinstall the duplex strainers with new gaskets of the same type that was removed from the vessel.

3.1.5. Upon reinstallation, the Contractor must prove that the system is free of leaks and functions as per the manufacturers guidelines.

3.1.6. The changeover handle must move through it's full stroke without obstruction.

**3.2. Location**

3.2.1. Engine Room

**3.3. Interferences**

3.3.1. Contractor is responsible for the identification of all interference items, their temporary removal, secure storage, and refitting to the vessel.

**4. PART 4 – PROOF OF PERFORMANCE**

**4.1. Inspection**

4.1.1. A visual inspection by the Contractor and TA in attendance, of general workmanship including that of piping, hardware, materials, and coatings must be conducted.

4.1.2. All work carried out must be verified correct by the Technical Authority and the attending RO Class inspector or TCMS inspector as required

**4.2. Testing**

4.2.1. Contractor must conduct a function test and test for watertight integrity.

**4.3. Certification**

4.3.1. Refer to Regulations in H-1 General Notes

**5. PART 5 - DELIVERABLES**

**5.1. Drawings/Reports**

5.1.1. The Contractor must produce two (2) electronic PDF copies of a final report for the TA upon completion of the above noted scope of work. The final report must contain the results of all inspections, testing, manufacturer information, part numbers and details of work completed..

5.1.2. The Contractor must include all associated documentation related to this specification as described H-1 General Notes - Section 5 - Documentation.

5.1.3. If any alterations from the original drawings have been made, the Contractor must include revised as fitted drawings as described in H-1 General Notes - Section 6 - Drawings.

**5.2. Spares**

5.2.1. N/A

**5.3. Training**

5.3.1. N/A



**5.4. Manuals**

- 5.4.1. The Contractor must include all associated manuals related to this specification as described in H-1 General Notes - Section 7 – Manuals.

	MLB	
Spec Item #: H-20	SPECIFICATION	
REPLACE SURVIVOR SPACE DECK PANELS		

### 1. PART 1: SCOPE:

- 1.1. The intent of this spec is to remove the existing survivor space deck panels and to replace with a new contractor supplied deck panels and matching hardware of black colour and same quality and specifications as indicated in the provided drawings.

### 2. PART 2: REFERENCES:

#### 2.1. Guidance Drawings/Nameplate Data

- 2.1.1. Drawing Number 47B MLB 110-600 – Survivors Compartment Flat  
 2.1.2. Drawing Number 47B MLB 110-620 – Survivors Compartment Arrangement and Securing Details

#### 2.2. Standards

- 2.2.1. See general Notes H-1

#### 2.3. Regulations

- 2.3.1. See General Notes H-1

#### 2.4. Government Furnished Material

- 2.4.1. N/A

#### 2.5. Contractor Furnished Material

- 2.5.1. The Contractor must supply everything that is required to perform the specified work unless otherwise stated, such as but not limited to the following: labour, materials, parts, tools, consumables, equipment, machinery, storage, shelters, staging, rigging, scaffolding, enclosures, power and heating. must
- 2.5.2. Refer to Appendix A for List of Original Suppliers or Appendix B for List of Alternate/Additional Suppliers.
- 2.5.3. All supplied and installed equipment must be certified by RO Class or TCMS as required.

### 3. PART 3: TECHNICAL DESCRIPTION:

#### 3.1. General

- 3.1.1. The Contractor must ensure prior to any work commencing that both the Contractor Basic Safety Familiarization and Pre Job Safety Assessment are completed and signed off.

- 3.1.2. The Contractor must remove the existing deck panels using care to not damage the aluminum deck framework and any equipment in the space. Any damaged support framework will be repaired or replaced via PSPC 1379 action.
- 3.1.3. The Contractor must remove any interference equipment ashore and store in an environment controlled space for re-installation.
- 3.1.4. The Contractor must install new deck panels of the same make, colour and quality of the material removed.
- 3.1.5. New flush mount hardware must be used for new deck panel installation.
- 3.1.6. The Contractor must re-install any interference items removed at the start of the work in the same location using new fittings.

### **3.2. Location**

- 3.2.1. Survivor Space

### **3.3. Interferences**

- 3.3.1. The Contractor is responsible for the identification of all interference items, their temporary removal, secure storage, and refitting to the vessel.

## **4. PART 4: PROOF OF PERFORMANCE:**

### **4.1. Inspection**

- 4.1.1. A visual inspection by the Contractor and TA in attendance, of general workmanship including that of piping, hardware, materials, and coatings must be conducted.
- 4.1.2. Refer to Regulations in H-1 General Notes

### **4.2. Testing**

- 4.2.1. All deck panels must be tested for fit and function.

### **4.3. Certification**

- 4.3.1. N/A

## **5. PART 5: DELIVERABLES:**

### **5.1. Drawings/Reports**

- 5.1.1. The Contractor must produce two (2) electronic PDF copies of a final report for the TA upon completion of the above noted scope of work. The final report must contain the results of all inspections, testing, manufacturer information, part numbers and details of work completed..
- 5.1.2. The Contractor must include all associated documentation related to this specification as described H-1 General Notes - Section 5 - Documentation.

### **5.2. Spares**

- 5.2.1. N/A

**5.3. Training**

5.3.1. N/A

**5.4. Manuals**

5.4.1. The Contractor must include all associated manuals related to this specification as described in H-1 General Notes - Section 7 - Manuals.

	MLB	
Spec Item #: H-21	SPECIFICATION	
<b>REPLACE BRIDGE SHOCK SEATS</b>		

## 1. PART 1: SCOPE:

- 1.1. The intent of this spec is to remove the existing four shock seats with pedestals and replace with new contractor supplied ShockWave seats and pedestals as described in section 2.5.

## 2. PART 2: REFERENCES:

### 2.1. Guidance Drawings/Nameplate Data

- 2.1.1. Drawing Number 47B MLB 110-630 – Enclosed Bridge Arrangement and Securing Details

Drawing Number 47B MLB150-030 – Open Bridge Deck

- 2.1.2. Drawing Number 47B MLB 600-010 – Outfit and Furnishings

### 2.2. Standards

- 2.2.1. See general Notes H-1

### 2.3. Regulations

- 2.3.1. See General Notes H-1

### 2.4. Government Furnished Material

- 2.4.1. N/A

### 2.5. Contractor Furnished Material

- 2.5.1. The Contractor must supply everything that is required to perform the specified work unless otherwise stated, such as but not limited to the following: labour, materials, parts, tools, consumables, equipment, machinery, storage, shelters, staging, rigging, scaffolding, enclosures, power and heating.

- 2.5.2. One (1) x SWP-1156A S2A High Mount G-Force with Folding Footrest – Enclosed bridge port

- 2.5.3. One (1) x SWP-1157A S2A High Mount G-Force with Folding Footrest – Enclosed bridge stbd

- 2.5.4. One (1) x SWP-1154A S3A G-Force Flip Up Seat With Deck Adapter – Open bridge stbd

- 2.5.5. One (1) x SWP-1155A S3A G-Force Seat With Deck Adapter – Open bridge port

- 2.5.6. Two (2) x SW-01983 High Pressure Pump

- 2.5.7. All parts must be approved by Technical Authority prior to Contractor purchasing.

- 2.5.8. Refer to Appendix A for List of Original Suppliers or Appendix B for List of Alternate/Additional Suppliers

- 2.5.9. All supplied and installed equipment must be certified by RO Class or TCMS as required

### **3. PART 3: TECHNICAL DESCRIPTION:**

#### **3.1. General**

- 3.1.1. The Contractor must ensure prior to any work commencing, that both the Contractor Basic Safety Familiarization and Pre Job Safety Assessment are completed and signed off.
- 3.1.2. The Contractor must remove the four existing shock seats and pedestals using care to not damage the aluminum deck.
- 3.1.3. The Contractor must remove the old equipment ashore and crate for shipment to CCG. Shipping charges will be treated as additional work and processed via PSPC 1379 action.
- 3.1.4. The Contractor must clean and inspect area in way of the old shock seats and pedestals. Prior to painting the area it must be inspected by the Technical Authority.
- 3.1.5. The Contractor must paint and preserve the disturbed area using the same painting scheme and materials as the surrounding area.
- 3.1.6. The Contractor must remove all grit or debris from the area prior to any painting application.
- 3.1.7. The Contractor must supply and install the new ShockWave seats and pedestals and connect to existing attachments.
- 3.1.8. The Contractor must verify the function of the seats and pedestals in accordance with the manufacturer's manual.
- 3.1.9. Contractor must supply two (2) ShockWave air pumps per vessel.

#### **3.2. Location**

- 3.2.1. Enclosed bridge and open bridge.

#### **3.3. Interferences**

- 3.3.1. The Contractor is responsible for the identification of all interference items, their temporary removal, secure storage, and refitting to the vessel.

### **4. PART 4: PROOF OF PERFORMANCE:**

#### **4.1. Inspection**

- 4.1.1. A visual inspection by the Contractor and TA in attendance, of general workmanship including that of piping, hardware, materials, and coatings must be conducted.

#### **4.2. Testing**

4.2.1. The Contractor must demonstrate all functions of the seats and pedestals to the Technical Authority. The Contractor must correct any deficiencies found and retest the seats.

**4.3. Certification**

4.3.1. The supplied seats and pedestals must be approved for heavy duty marine applications and must be delivered with certification documentation. Seats and pedestals must not be installed until certification is reviewed and approved by the Technical Authority.

**5. PART 5: DELIVERABLES:**

**5.1. Drawings/Reports**

5.1.1. The Contractor must supply the Technical Authority with three (3) electronic copies of drawing of the seats and pedestals and installation.

5.1.2. The Contractor must produce two (2) electronic PDF copies of a final report for the TA upon completion of the above noted scope of work. The final report must contain the results of all inspections, testing, manufacturer information, part numbers and details of work completed..

5.1.3. The Contractor must include all associated documentation related to this specification as described H-1 General Notes - Section 5 - Documentation.

**5.2. Spares**

5.2.1. N/A

**5.3. Training**

5.3.1. N/A

**5.4. Manuals**

5.4.1. The Contractor must include all associated manuals related to this specification, in English and French, as described in H-1 General Notes - Section 7 – Manuals.

	MLB	
Spec Item #: H-22	SPECIFICATION	
<b>ALUMINUM RENEWAL IN AFT BUOYANCY COMPARTMENTS AND FORWARD DECK LOCKERS</b>		

## 1. PART 1: SCOPE

- 1.1. The intent of this specification is to cut out and replace pitted aluminum in the three aft buoyancy compartments and two forward deck lockers.
- 1.2. This work must be carried out in conjunction with the following specification items:
- a) H-08 Overhaul Hatches/Doors
  - b) Topside painting

## 2. PART 2: REFERENCES

### 2.1. Guidance Drawings/Nameplate Data

- 2.1.1. Drawing Number 47B MLB 150-060 – Forward Deck Locker
- 2.1.2. Drawing Number 47B MLB 150-090 – Aft Buoyancy Box
- 2.1.3. Drawing Number 47B MLB 110-100 – Main Deck

### 2.2. Standards

- 2.2.1. See General Notes H-1

### 2.3. Regulations

- 2.3.1. See General Notes H-1

### 2.4. Government Furnished Material

- 2.4.1. N/A

### 2.5. Contractor Supplied Material

- 2.5.1. The Contractor must supply everything that is required to perform the specified work unless otherwise stated, such as but not limited to the following: labour, materials, parts, tools, consumables, equipment, machinery, storage, shelters, staging, rigging, scaffolding, enclosures, power and heating.
- 2.5.2. Refer to Appendix A for List of Original Suppliers or Appendix B for List of Alternate/Additional Suppliers

## 3. PART 3: TECHNICAL DESCRIPTION:

### 3.1. General

- 3.1.1. The vessels have three buoyancy compartments at the stern of the vessel and two storage lockers forward. These spaces have pitting on the deck of the buoyancy compartment and around the anchor pocket in the storage lockers.



- 3.1.2. The Contractor must open up the spaces and remove any interference items to allow a complete survey of the spaces.
- 3.1.3. The Contractor must clean the entire space to bare aluminum and prepare for inspection by the Technical Authority and the ABS Inspector. The areas must be replaced must be identified and written confirmation of the area must be dealt with provided the Contractor.
- 3.1.4. The Contractor must obtain the services of an ABS Certified company to carry out a minimum twenty (20) UT Shots for the deck in the aft buoyancy box and forward deck lockers. Individual taking the readings must be minimum Level 2 Certified. Contractor must also include the unit cost per shot including prepping, priming and person lift and operator. Actual cost must be adjusted up or down via PSPC 1379 action.
- 3.1.5. The Contractor must quote on replacing one (1) square meter of aluminum plate in each space of aluminum plate of the same thickness and type as currently fitted. Quoted prices will be used to prorate the cost to reflect an increase or decrease in area must be replaced.
- Port-10sq foot
  - Mid- 7.9sq foot
  - Stbd- 7sq foot
  - Anchor holds are both 12.5sq foot.
- 3.1.6. The Contractor must cut out the identified area using care to not damage structure and protecting edges for welding inserts. On completion of removals the Contractor must present the area to the Technical Authority and the ABS Inspector for a further inspection. Insertion of new plate must not commence until approval received from the Technical Authority
- 3.1.7. The Contractor must prepare edges and insert plates for reinsertion. All work must be overseen and verified by an independent Contractor supplied W47.2 approved welding inspector.
- 3.1.8. The Contractor must weld in the inserts and prepare welds for inspection. The contractor must quote on having an approved NDT specialist provide twenty (20) x-rays of welds in sites selected by the Technical Authority and the RO Class Inspector. Any rejected welds must be redone and re x-rayed. The Technical Authority and the RO Class Inspector will be the final judge of workmanship.
- 3.1.9. The Contractor must close up the spaces using new gaskets in the forward spaces.
- 3.2. Paint**
- 3.3.** The Contractor must paint and preserve the disturbed area using the same painting scheme and materials as the surrounding area.
- 3.4. Interference**

- 3.4.1. The Contractor must remove and store any interference items and reinstall on completion of the work.

**4. PART 4: PROOF OF PERFORMANCE:**

**4.1. Inspection**

- 4.1.1. A visual inspection by the Contractor and TA in attendance, of general workmanship including that of piping, hardware, materials, and coatings must be conducted.
- 4.1.2. All work carried out must be verified correct by the Technical Authority and the attending RO Class Inspector or TCMS as required

**4.2. Testing**

- 4.2.1. The Contractor must conduct a leak test using water of each space and present for inspection by the Technical Authority and the RO Class Inspector. Any leaks must be repaired and retested.

**4.3. Certification**

- 4.3.1. Contractor must provide Class acceptance documents for the repaired tanks.

**5. PART 5: DELIVERABLES:**

**5.1. Drawings/Reports**

- 5.1.1. The Contractor must produce two (2) electronic PDF copies of a final report for the TA upon completion of the above noted scope of work. The final report must contain the results of all inspections, testing, manufacturer information, part numbers and details of work completed.
- 5.1.2. The Contractor must include all associated documentation related to this specification as described H-1 General Notes - Section 5 - Documentation

**5.2. Spares**

- 5.2.1. N/A

**5.3. Training**

- 5.3.1. N/A

**5.4. Manuals**

- 5.4.1. N/A

	MLB	
Spec Item #: H-23	SPECIFICATION	
REPLACE SEAWATER PIPING		

### 1. PART 1: SCOPE:

- 1.1. The intent of this specification is to replace existing seawater piping with new material.
- 1.2. This work must be carried out in conjunction with the following specification items:
- a) H-14 Replace Through Hull Connections
  - b) H-17 Repair Insulation in Engine room and Survivor Space

### 2. PART 2: REFERENCES:

#### 2.1. Guidance Drawings/Nameplate Data

- 2.1.1. Drawing Number 47B MLB 505-022 - Piping, Hull (Sea Water Cooling)
- 2.1.2. Drawing Number 47B MLB 505-023 – Piping in Hull, Bilge System
- 2.1.3. Drawing Number 47B MLB 521-010 – Dewatering Pump Arrangement and Details
- 2.1.4. Drawing Number 47B MLB 505-040 – Piping, Hull Fire Pump Hand Operated

#### 2.2. Standards

- 2.2.1. See General Notes H-1

#### 2.3. Regulations

- 2.3.1. See General Notes H-1

#### 2.4. Government Furnished Material

- 2.4.1. N/A

#### 2.5. Contractor Supplied Material

- 2.5.1. The Contractor must supply everything that is required to perform the specified work unless otherwise stated, such as but not limited to the following: labour, materials, parts, tools, consumables, equipment, machinery, storage, shelters, staging, rigging, scaffolding, enclosures, power and heating.
- 2.5.2. Refer to Appendix A for List of Original Suppliers or Appendix B for List of Alternate/Additional Suppliers
- 2.5.3. All supplied and installed equipment must be certified by RO Class or TCMS as required

### 3. PART 3: TECHNICAL DESCRIPTION:

#### 3.1. General

- 3.1.1. The Contractor must remove all components of the existing piping systems and must install new piping system materials as per original arrangement and function in accordance with original drawings.

### **3.2. Removals**

- 3.2.1. The Contractor must isolate, release, disconnect and remove all salt water piping system materials from installed locations and remove from vessel.
- 3.2.2. Scope of removal must include all suction and discharge piping used for seawater cooling of the various systems, suction and discharge piping of hand operated fire pump.
- 3.2.3. All associated valves must be included as removals.
- 3.2.4. All deck and bulkhead penetrations must be cleaned and presented to the TA for inspection. Repairs will be completed via PSPC 1379 action.
- 3.2.5. All fixed portions of pipe hangers and supports must be retained as found.
- 3.2.6. The Contractor must treat all removals as Class C material.

### **3.3. Installation**

- 3.3.1. The Contractor must install new material as per original system arrangement and in accordance with original system drawings.
- 3.3.2. All piping, valves, penetrations, and other fittings must be as defined on original drawings and Class approved for application. If any discrepancy between drawings and Class approval requirements Class approval must take precedent.
- 3.3.3. New pipe runs must be as per original arrangement and original pipe hangers and supports must be used to carry new piping systems.

### **3.4. Interference**

- 3.4.1. The Contractor must remove and store any interference items and reinstall on completion of the work.

## **4. PART 4: PROOF OF PERFORMANCE:**

### **4.1. Inspection**

- 4.1.1. All work carried out must be verified correct and approved by the Technical Authority and the attending RO Class Inspector or TCMS as required
- 4.1.2. Refer to Regulations in H-1 General Notes

### **4.2. Testing**

- 4.2.1. The Contractor must pressure test completed sea water systems to 1.5 times working pressure.
- 4.2.2. The Contractor must demonstrate the correct function of all sea water piping system valves.

4.2.3. The Contractor must demonstrate the system is free of leaks. If leaks are found, the leaks must be repaired and tested again until proven leak free.

**4.3. Trials**

4.3.1. The Contractor must pressurize salt water piping systems and prove correct function of all components.

**5. PART 5: DELIVERABLES:**

**5.1. Drawings/Reports**

5.1.1. The Contractor must provide complete Bill of Materials for new piping systems and OEM specification, parts and instruction information for all parts used where applicable.

5.1.2. The Contractor must produce two (2) electronic PDF copies of a final report for the TA upon completion of the above noted scope of work. The final report must contain the results of all inspections, testing, manufacturer information, part numbers and details of work completed..

5.1.3. The Contractor must include all associated documentation related to this specification as described H-1 General Notes - Section 5 - Documentation.

**5.2. Spares**

5.2.1. N/A

**5.3. Training**

5.3.1. N/A

**5.4. Manuals**

5.4.1. N/A

**5.5. Certification**

5.5.1. The Contractor must provide Class acceptance documents for installed system and all applicable system components.

	MLB	
Spec Item #: H-24	SPECIFICATION	
REPLACE TOW REEL		

### 1. PART 1: SCOPE:

- 1.1. The intent of this spec is to remove the existing tow reel and to replace with a new contractor supplied tow reel system of the same size and quality IAW the original drawings.

### 2. PART 2: REFERENCES:

#### 2.1. Guidance Drawings/Nameplate Data

- 2.1.1. Drawing Number 47B MLB 582-030 – Towline Reel Arrangement  
 2.1.2. Drawing Number 47B MLB 150-020 – Deckhouse Side Port  
 2.1.3. Drawing Number 47B MLB 150-050 – Aft Bulkhead  
 2.1.4. Drawing Number 47B MLB 300-020 – Electrical One Line Diagram

#### 2.2. Standards

- 2.2.1. See General Notes H-1

#### 2.3. Regulations

- 2.3.1. See General Notes H-1

#### 2.4. Government Furnished Material

- 2.4.1. N/A

#### 2.5. Contractor Furnished Material

- 2.5.1. The Contractor must supply everything that is required to perform the specified work unless otherwise stated, such as but not limited to the following: labour, materials, parts, tools, consumables, equipment, machinery, storage, shelters, staging, rigging, scaffolding, enclosures, power and heating. must
- 2.5.2. Refer to Appendix A for List of Original Suppliers or Appendix B for List of Alternate/Additional Suppliers.
- 2.5.3. All supplied and installed equipment must be certified by RO Class or TCMS as required.

### 3. PART 3: TECHNICAL DESCRIPTION:

#### 3.1. General

- 3.1.1. The Contractor must ensure prior to any work commencing that both the Contractor Basic Safety Familiarization and Pre Job Safety Assessment are completed and signed off.

- 3.1.2. The Contractor must remove the existing tow reel using care to not damage the aluminum deck and any equipment in the vicinity.
- 3.1.3. The Contractor must remove the old equipment ashore and crate for shipment to CCG. Shipping charges will be treated as additional work and processed via PSPC 1379 action.
- 3.1.4. The Contractor must clean and inspect area in way of the old tow reel. Prior to painting the area it must be inspected by the Technical Authority.
- 3.1.5. The Contractor must paint and preserve the disturbed area using the same painting scheme and materials as the surrounding area.
- 3.1.6. The Contractor must supply and install the new tow reel and connect to existing attachments.
- 3.1.7. The Contractor must supply and install new light weight rope of the same length and size as currently fitted on large and small tow reels.
- 3.1.8. The Contractor must remove all grit from the area prior to any painting application.
- 3.1.9. The Contractor must verify the function of the reel in accordance with the manufacturer's manual.

**3.2. Location**

- 3.2.1. After deck

**3.3. Interferences**

- 3.3.1. The Contractor is responsible for the identification of all interference items, their temporary removal, secure storage, and refitting to the vessel.

**4. Part 4: PROOF OF PERFORMANCE:**

**4.1. Inspection**

- 4.1.1. A visual inspection by the Contractor and TA in attendance, of general workmanship including that of piping, hardware, materials, and coatings must be conducted.
- 4.1.2. All work carried out must be verified correct by the Technical Authority and the attending RO Class Inspector or TCMS as required
- 4.1.3. Refer to Regulations in H-1 General Notes

**4.2. Testing**

- 4.2.1. The Contractor must demonstrate all functions of the reel to the Technical Authority and the attending RO Class inspector.
- 4.2.2. The reel must function in accordance with the manufacturer's specifications.
- 4.2.3. The Contractor must correct any deficiencies found and retest the reel.

**4.3. Certification**

4.3.1. The supplied reel must be approved for heavy duty marine applications and must be delivered with certification documentation. Reel must not be installed until certification is reviewed by the Technical Authority.

4.3.2. Ropes or towlines must be supplied with certificate from TCMS RO.

**5. Part 5: DELIVERABLES:**

**5.1. Drawings/Reports**

5.1.1. The Contractor must produce two (2) electronic PDF copies of a final report for the TA upon completion of the above noted scope of work. The final report must contain the results of all inspections, testing, manufacturer information, part numbers and details of work completed..

5.1.2. See H-1 General Notes Section 6 Drawings

5.1.3. The Contractor must include all associated documentation related to this specification as described H-1 General Notes - Section 5 - Documentation.

**5.2. Spares**

5.2.1. N/A

**5.3. Training**

5.3.1. The Contractor must demonstrate the operation of the reel to the Technical Authority.

**5.4. Manuals**

5.4.1. The Contractor must supply three (3) hard copies of the manufacturer's operation and maintenance manual to the Technical Authority in Bi-lingual format French/English as described in H-1 General Notes - Section 7 - Manuals.



	MLB	
Spec Item #: H-25	SPECIFICATION	
REPLACE WINDOW WIPER SYSTEM		

### 1. PART 1: SCOPE:

- 1.1. The intent of this spec is to replace the window wipers on the wheelhouse windows.
- 1.2. This work must be carried out in conjunction with the topside painting and H-20 Refurbish Windows.
- 1.3. Work involves the four front windows on the wheelhouse.

### 2. PART 2: REFERENCES:

#### 2.1. Guidance Drawings/Nameplate Data

- 2.1.1. Drawing Number 47B MLB 320-030 – Window Heaters/Blowers/Wipers
- 2.1.2. Drawing Number 47B MLB 320-010 – Electrical One Line Diagram

#### 2.2. Standards

- 2.2.1. See H-1 General Notes

#### 2.3. Regulations

- 2.3.1. See H-1 General Notes

#### 2.4. Government Furnished Material

- 2.4.1. N/A

#### 2.5. Contractor Furnished Material

- 2.5.1. The Contractor must supply everything that is required to perform the specified work unless otherwise stated, such as but not limited to the following: labour, materials, parts, tools, consumables, equipment, machinery, storage, shelters, staging, rigging, scaffolding, enclosures, power and heating. must
- 2.5.2. Wynn, Model Type C Straight Line Wiper, Stroke or equivalent
- 2.5.3. 533MM Motor; Parvalux, Model PM3d M, 24V DC, 4.5A, 68W, 300RPM or equivalent.
- 2.5.4. Refer to Appendix A for List of Original Suppliers or Appendix B for List of Alternate/Additional Suppliers.
- 2.5.5. All supplied and installed equipment must be certified by RO Class or TCMS as required.

### 3. Part 3: TECHNICAL DESCRIPTION:

#### 3.1. General

- 3.1.1. The Contractor must ensure prior to any work commencing that both the Contractor Basic Safety Familiarization and Pre Job Safety Assessment are completed and signed off
- 3.1.2. The Contractor must detach the wipers and motors and remove from the vessel to secure protected storage.
- 3.1.3. The Contractor must hand tool clean the area exposed by the wiper removal and prepare for inspection by the Technical Authority.
- 3.1.4. The Contractor must paint the exposed area using the same paint system as used for the rest of the superstructure.
- 3.1.5. The Contractor must protect the wiring and controls for reuse.
- 3.1.6. The Contractor must install the new Contractor supplied wipers and motors. Supplied system must be of equal or better quality and performance than the system removed and be approved for operation in a marine environment.
- 3.1.7. The Contractor must demonstrate the operation of the new wipers to the Technical Authority.
- 3.1.8. Upon completion of reinstallation the Technical Authority must inspect the installation and operation. Any defects must be corrected and presented for re-inspection.

### **3.2. Location**

- 3.2.1. Vessel wheelhouse front.

### **3.3. Interferences**

- 3.3.1. The Contractor is responsible for the identification of all interference items, their temporary removal, storage, and refitting to the vessel.

## **4. Part 4: PROOF OF PERFORMANCE:**

### **4.1. Inspection**

- 4.1.1. A visual inspection by the Contractor and TA in attendance, of general workmanship including that of piping, hardware, materials, and coatings must be conducted.
- 4.1.2. All work carried out must be verified correct by the Technical Authority and the attending RO Class Inspector or TCMS as required

### **4.2. Testing**

- 4.2.1. The Contractor must prove the correct function of the window wipers.
- 4.2.2. The Contractor must conduct all specified testing and notify the Technical Authority of the schedule for the testing and inspection.
- 4.2.3. The Technical Authority must witness all specified testing.

### **4.3. Certification**

- 4.3.1. Refer to Regulations in H-1 General Notes

**5. Part 5: DELIVERABLES:**

**5.1. Drawings/Reports**

- 5.1.1. The Contractor must produce two (2) electronic PDF copies of a final report for the TA upon completion of the above noted scope of work. The final report must contain the results of all inspections, testing, manufacturer information, part numbers and details of work completed..
- 5.1.2. The Contractor must include all associated documentation related to this specification as described H-1 General Notes - Section 5 - Documentation.

**5.2. Spares**

- 5.2.1. N/A

**5.3. Training**

- 5.3.1. N/A

**5.4. Manuals**

- 5.4.1. The Contractor must supply two Bi-lingual English-French manuals to the Technical Authority as described in H-1 General Notes - Section 7 – Manuals.

	MLB	
Spec Item #: H-26	SPECIFICATION	
REPLACE WINDSCREEN ON OPEN BRIDGE		

### 1. PART 1: SCOPE:

- 1.1. The intent of this spec is to remove the existing windscreen on the open bridge and to replace with a new contractor supplied windscreen of the same material and quality.

### 2. PART 2: REFERENCES:

#### 2.1. Guidance Drawings/Nameplate Data

- 2.1.1. Drawing Number 47B MLB 625-020 – Windscreen  
 2.1.2. Drawing Number 47B MLB 801-005 – Deckhouse Lines  
 2.1.3. Drawing Number 47B MLB 150-080 – Enclosed Bridge Top

#### 2.2. Standards

- 2.2.1. See General Notes H-1

#### 2.3. Regulations

- 2.3.1. See General Notes H-1

#### 2.4. Government Furnished Material

- 2.4.1. N/A

#### 2.5. Contractor Furnished Material

- 2.5.1. The Contractor must supply everything that is required to perform the specified work unless otherwise stated, such as but not limited to the following: labour, materials, parts, tools, consumables, equipment, machinery, storage, shelters, staging, rigging, scaffolding, enclosures, power and heating. must
- 2.5.2. Refer to Appendix A for List of Original Suppliers or Appendix B for List of Alternate/Additional Suppliers.

### 3. PART 3: TECHNICAL DESCRIPTION:

#### 3.1. General

- 3.1.1. The Contractor must ensure prior to any work commencing that both the Contractor Basic Safety Familiarization and Pre Job Safety Assessment are completed and signed off
- 3.1.2. The Contractor must remove the existing windscreen and any fitted gaskets using care to not damage the aluminum supports.
- 3.1.3. The Contractor must remove any interference equipment ashore and store in an environment controlled space for re-installation

- 3.1.4. The Contractor must clean the supports to bare aluminum and prepare for inspection by the Technical Authority. Any defects will be treated as a work arising via PSPC 1379 action.
- 3.1.5. The Contractor must install new windscreens of the same material, make and quality of the material removed using new rubber gaskets.
- 3.1.6. The Contractor must re-install any interference items removed at the start of the work in the same location using new fittings.
- 3.1.7. The Contractor must paint the exposed area using the same paint system as used for the surrounding area.

**3.2. Location**

- 3.2.1. Open bridge

**3.3. Interferences**

- 3.3.1. The Contractor is responsible for the identification of all interference items, their temporary removal, secure storage, and refitting to the vessel.

**4. PART 4: PROOF OF PERFORMANCE:**

**4.1. Inspection**

- 4.1.1. A visual inspection by the Contractor and TA in attendance, of general workmanship including that of piping, hardware, materials, and coatings must be conducted.
- 4.1.2. Refer to Regulations in H-1 General Notes

**4.2. Testing**

- 4.2.1. N/A

**4.3. Certification**

- 4.3.1. N/A

**5. PART 5: DELIVERABLES:**

**5.1. Drawings/Reports**

- 5.1.1. The Contractor must produce two (2) electronic PDF copies of a final report for the TA upon completion of the above noted scope of work. The final report must contain the results of all inspections, testing, manufacturer information, part numbers and details of work completed..
- 5.1.2. The Contractor must include all associated documentation related to this specification as described H-1 General Notes - Section 5 - Documentation.

**5.2. Spares**

- 5.2.1. N/A

**5.3. Training**

5.3.1. N/A

**5.4. Manuals**

5.4.1. N/A

	MLB	
Spec Item #: H-27	SPECIFICATION	
<b>IMPROVE BRIDGE DEFOGGING FAN SYSTEMS</b>		

## 1. PART 1 - SCOPE

- 1.1. The intent of this spec is to improve the function of the defogging system for windows in the wheelhouse.
- 1.2. This work must be carried out in Conjunction with the topside painting, wiper replacement and refurbishment of the windows.

## 2. PART 2 – REFERENCES

### 2.1. Guidance Drawings/Nameplate Data

- 2.1.1. Drawing Number 47B MLB 320-030 – Window Heaters/Blowers/Wipers
- 2.1.2. Drawing Number 47B MLB 320-010 – Electrical One Line Diagram
- 2.1.3. Drawing Number 47B MLB 438-010 – Console Arrangement
- 2.1.4. Drawing Number 47B MLB 505-030 – Piping Arrangement in Deck House
- 2.1.5. Drawing Number 47B MLB 625-101 – Window List
- 2.1.6. Drawing Number 47B MLB 512-010 – HVAC Details and Arrangement

### 2.2. Standards

- 2.2.1. See General Notes H-1

### 2.3. Regulations

- 2.3.1. See General Notes H-1

### 2.4. Government Furnished Material

- 2.4.1. N/A

### 2.5. Contractor Furnished Material

- 2.5.1. The Contractor must supply everything that is required to perform the specified work unless otherwise stated, such as but not limited to the following: labour, materials, parts, tools, consumables, equipment, machinery, storage, shelters, staging, rigging, scaffolding, enclosures, power and heating. must
- 2.5.2. Current blower ATTWOOD, Turbo 3000, 120 CFM, 12V, 2.6 A. Replacement must be same make delivering 250 CFM
- 2.5.3. Refer to Appendix A for List of Original Suppliers or Appendix B for List of Alternate/Additional Suppliers

## 3. PART 3 – TECHNICAL DESCRIPTION

**3.1. General**

- 3.1.1. The Contractor must ensure prior to any work commencing that both the Contractor Basic Safety Familiarization and Pre Job Safety Assessment are completed and signed off.
- 3.1.2. The Contractor must disconnect the wiring from the current blower and protect the wiring for reuse.
- 3.1.3. The Contractor must detach the blower fan unit and remove from the vessel to secure protected storage.
- 3.1.4. The Contractor must remove any gasket material and hand tool clean the landing surfaces.
- 3.1.5. The Contractor must verify the wiring and determine it is free of defects. Any defects found will be dealt with via PSPC 1379 action.
- 3.1.6. The Contractor must install the new blower unit using new gasket material.
- 3.1.7. The Contractor must reconnect the electrical system and verify the operation and present the system to the Technical Authority for inspection.

**3.2. Location**

- 3.2.1. Wheelhouse front windows.

**3.3. Interferences**

- 3.3.1. The Contractor is responsible for the identification of all interference items, their temporary removal, storage, and refitting to the vessel.

**4. PART 4 – PROOF OF PERFORMANCE**

**4.1. Inspection**

- 4.1.1. A visual inspection by the Contractor and TA in attendance, of general workmanship including that of piping, hardware, materials, and coatings must be conducted.

**4.2. Testing**

- 4.2.1. The Contractor must demonstrate the system by allowing the blower to operate for one hour. The Technical must be called to witness the test.
- 4.2.2. The Contractor must prove the system is free of electrical grounds.

**4.3. Certification**

- 4.3.1. N/A

**5. PART 5 – DELIVERABLES**

**5.1. Drawings/Reports**



5.1.1. The Contractor must produce two (2) electronic PDF copies of a final report for the TA upon completion of the above noted scope of work. The final report must contain the results of all inspections, testing, manufacturer information, part numbers and details of work completed..

5.1.2. The Contractor must include all associated documentation related to this specification as described H-1 General Notes - Section 5 - Documentation.

**5.2. Spares**

5.2.1. N/A

**5.3. Training**

5.3.1. N/A

**5.4. Manuals**

5.4.1. The Contractor must include all associated manuals related to this specification as described in H-1 General Notes - Section 7 - Manuals.

	MLB	
Spec Item #: H-28	SPECIFICATION	
EXTERIOR DECKS		

## 1. PART 1 - SCOPE

- 1.1.** The intent of this spec is to remove the existing non-skid deck decals, clean the entire deck and to replace decals with a new contractor supplied 3M 710 Safety Walk (not 3M 610 Safety Walk as in original drawings) decals of the same make colour and quality.

## 2. PART 2 – REFERENCES

### 2.1. Guidance Drawings/Nameplate Data

- 2.1.1. Drawing Number 47B MLB 634-010 Deck Covering

### 2.2. Standards

- 2.2.1. See General Notes H-1

### 2.3. Regulations

- 2.3.1. See General Notes H-1

### 2.4. Government Furnished Material

- 2.4.1. N/A

### 2.5. Contractor Furnished Material

- 2.5.1. The Contractor must supply everything that is required to perform the specified work unless otherwise stated, such as but not limited to the following: labour, materials, parts, tools, consumables, equipment, machinery, storage, shelters, staging, rigging, scaffolding, enclosures, power and heating. must
- 2.5.2. Refer to Appendix A for List of Original Suppliers or Appendix B for List of Alternate/Additional Suppliers.

## 3. PART 3 – TECHNICAL DESCRIPTION

### 3.1. General

- 3.1.1. The Contractor must ensure prior to any work commencing that both the Contractor Basic Safety Familiarization and Pre Job Safety Assessment are completed and signed off.
- 3.1.2. The Contractor must remove the existing non-skid decals using care to not damage the aluminum deck and any equipment.
- 3.1.3. Any gouging damage to the aluminium deck must be repaired by clad welding and then ground flush.

- 3.1.4. The Contractor must remove any interference equipment ashore and store in an environment controlled space for re-installation.
- 3.1.5. The Contractor must clean the bare aluminum decks using an acid wash and prepare for inspection by the Technical Authority and the ABS Class Inspector. Special attention must be paid to ensure complete removal of old decal adhesive. Any defects will be treated as a work arising via PSPC 1379 action.
- 3.1.6. On completion of the acid wash the deck must be rinsed with fresh water and wiped dry.
- 3.1.7. The Contractor must apply new deck decals of the 3M 710 Safety Walk. Installation it must be in accordance with the manufacturer's instructions and Drawing Number 47B MLB 634-010 Deck Covering. Final sizes and location of decals must be verified by the Technical Authority.
- 3.1.8. The Contractor must re-install any interference items removed at the start of the work in the same location using new fittings.

**3.2. Location**

- 3.2.1. Exterior Decks

**3.3. Interferences**

- 3.3.1. The Contractor is responsible for the identification of all interference items, their temporary removal, secure storage, and refitting to the vessel.

**4. PART 4 – PROOF OF PERFORMANCE**

**4.1. Inspection**

- 4.1.1. A visual inspection by the Contractor and TA in attendance, of general workmanship including that of piping, hardware, materials, and coatings must be conducted.

**4.2. Testing**

- 4.2.1. N/A

**4.3. Certification**

- 4.3.1. N/A

**5. PART 5 – DELIVERABLES**

**5.1. Drawings/Reports**

- 5.1.1. The Contractor must produce two (2) electronic PDF copies of a final report for the TA upon completion of the above noted scope of work. The final report must contain the results of all inspections, testing, manufacturer information, part numbers and details of work completed..

5.1.2. The Contractor must include all associated documentation related to this specification as described H-1 General Notes - Section 5 - Documentation.

**5.2. Spares**

5.2.1. The Contractor must supply one (1) complete set of spare decals per vessel to the Technical Authority.

**5.3. Training**

5.3.1. N/A

**5.4. Manuals**

5.4.1. The Contractor must include all associated manuals related to this specification as described in H-1 General Notes - Section 7 – Manuals.

	MLB	
Spec Item #: H-29	SPECIFICATION	
FUEL TANK		

## 1. PART 1 - SCOPE

- 1.1. The intent of this specification is to open the Fuel Tank, drain, clean and reseal the manholes using new gaskets suitable for use with diesel fuel oil.
- 1.2. This work must be carried out in conjunction with E-108 Replace Fuel Gauges and Senders and H-4 Replace Quick Closing Fuel Valves.

## 2. PART 2 – REFERENCES

### 2.1. Guidance Drawings/Nameplate Data

- 2.1.1. Drawing Number 47B MLB 110-208 – Fuel Tank
- 2.1.2. Drawing Number 47B MLB 167-010 – Hatches and Manholes

### 2.2. Standards

- 2.2.1. See H-1 General Notes

### 2.3. Regulations

- 2.3.1. See H-1 General Notes

### 2.4. Government Furnished Material

- 2.4.1. N/A

### 2.5. Contractor Furnished Material

- 2.5.1. The Contractor must supply everything that is required to perform the specified work unless otherwise stated, such as but not limited to the following: labour, materials, parts, tools, consumables, equipment, machinery, storage, shelters, staging, rigging, scaffolding, enclosures, power and heating. must
- 2.5.2. Refer to Appendix A for List of Original Suppliers or Appendix B for List of Alternate/Additional Suppliers.
- 2.5.3. All supplied and installed equipment must be certified by the RO.

## 3. PART 3 – TECHNICAL DESCRIPTION

### 3.1. General

- 3.1.1. The Contractor must ensure prior to any work commencing that both the Contractor Basic Safety Familiarization and Pre Job Safety Assessment are completed and signed off

- 3.1.2. The Contractor must pump out and dispose of any fuel in the tank when the vessel arrives at the shipyard. Contractor must dispose of the fuel in a manner approved by the government regulations in its province.
- 3.1.3. The Contractor must remove the tank covers and gaskets. Tank covers must be removed ashore, cleaned and prepared for re-installation.
- 3.1.4. The Contractor must remove any residual fuel in the tank, ensure the tank is gas free and wipe the tank clean. Cleaned tank must be inspected by the Technical Authority and the ABS Inspector.
- 3.1.5. The Contractor must re-close the tank using new gasket material of the same material as the existing gasket. Note: Centre of the gasket must be cut out.
- 3.1.6. The Contractor must fill the tank to 90% capacity using contractor supplied fuel. This Fuel must be used for dock and sea trials. Technical Authority will indicate the type of diesel used in the vessels area of operation.

### **3.2. Location**

- 3.2.1. Below the deck in the Survivor's Compartment, on the centerline of the vessel.

### **3.3. Interferences**

- 3.3.1. Contractor is responsible for the identification of all interference items, their temporary removal, storage, and refitting to the vessel.

## **4. PART 4 – PROOF OF PERFORMANCE**

### **4.1. Inspection**

- 4.1.1. A visual inspection by the Contractor and TA in attendance, of general workmanship including that of piping, hardware, materials, and coatings must be conducted.
- 4.1.2. All work must be carried out in accordance to Class and Transport Canada requirements as verified by the ABS Class Inspector and the Technical Authority
- 4.1.3. Refer to Regulations in H-1 General Notes

### **4.2. Testing**

- 4.2.1. The Contractor must hydrostatically test the tank. Contractor must remove all water from the tank and fuel piping prior to filling with diesel fuel.
- 4.2.2. The Technical Authority must witness all specified testing.

### **4.3. Certification**

- 4.3.1. N/A

## **5. PART 5 – DELIVERABLES**

### **5.1. Drawings/Reports**

- 5.1.1. The Contractor must produce two (2) electronic PDF copies of a final report for the TA upon completion of the above noted scope of work. The final report must contain

the results of all inspections, testing, manufacturer information, part numbers and details of work completed..

5.1.2. The Contractor must include all associated documentation related to this specification as described H-1 General Notes - Section 5 - Documentation.

**5.2. Spares**

5.2.1. N/A

**5.3. Training**

5.3.1. N/A

**5.4. Manuals**

5.4.1. N/A

	MLB	
Spec Item #: H-30	SPECIFICATION	
REPLACE GILMAN FENDERS		

## 1. PART 1 - SCOPE

- 1.1. The intent of this specification is to renew the Gilman Fenders. Contractor must quote on all fenders but TA may elect to retain certain fenders in exchange for a credit via PSPC 1379 action.
- 1.2. This work must be carried out in Conjunction with the painting of the hull and superstructure.

## 2. PART 2 – REFERENCES

### 2.1. Guidance Drawings/Nameplate Data

- 2.1.1. Drawing Number 47B MLB 611-020 - Fender Arrangement

### 2.2. Standards

- 2.2.1. See General Notes H-1

### 2.3. Regulations

- 2.3.1. See General Notes H-1

### 2.4. Government Furnished Material

- 2.4.1. N/A

### 2.5. Contractor Furnished Material

- 2.5.1. The Contractor must supply everything that is required to perform the specified work unless otherwise stated, such as but not limited to the following: labour, materials, parts, tools, consumables, equipment, machinery, storage, shelters, staging, rigging, scaffolding, enclosures, power and heating. must
- 2.5.2. Refer to Appendix A for List of Original Suppliers or Appendix B for List of Alternate/Additional Suppliers.
- 2.5.3. All supplied and installed equipment must be certified by the RO.
- 2.5.4. 51917-BOW

MLB FENDER, BOW  
 TYPE: 600; COLOR: BLACK  
 P/N 47 MLB-011-BW

51917-STERN

MLB FENDER, STERN  
 TYPE: 600; COLOR: BLACK



P/N 47 MLB-011-ST

51917-MPORT

MLB MID RAIL (PORT)

TYPE: 600; COLOR: BLACK

P/N 47 MLB-011-MP

51917-MSTBD

MLB MID RAIL (STBD)

TYPE: 600; COLOR: BLACK

P/N 47 MLB-011-MS

51917-LPORT

MLB LOWER RAIL (PORT)

TYPE: 600; COLOR: BLACK

P/N 47 MLB-011-LP

51917-LSTBD

MLB LOWER RAIL (STBD)

TYPE: 600; COLOR: BLACK

P/N 47 MLB-011-LS

### **3. PART 3 – TECHNICAL DESCRIPTION**

#### **3.1. General**

- 3.1.1. The Contractor must ensure prior to any work commencing that both the Contractor Basic Safety Familiarization and Pre Job Safety Assessment are completed and signed off.
- 3.1.2. The Contractor must remove and dispose of the existing fenders. The contractor must provide a disposal certificate indicating fenders were disposed of in accordance with the local government regulations.
- 3.1.3. The Contractor must hand tool clean the area behind the fenders and present the cleaned area to the Technical authority and the ABS inspector for inspection.
- 3.1.4. The Contractor must inspect the connection pieces and present to the Technical Authority for inspection.
- 3.1.5. The Contractor must supply and install new fenders using new nuts and washers. Nuts and washers must be the same material and quality as the fittings removed.

- 3.1.6. The Contractor must follow manufacturers installation instructions.
- 3.1.7. The Contractor must present the installed fenders to the Technical Authority for inspection and acceptance.

**3.2. Location**

- 3.2.1. Exterior Hull

**3.3. Interferences**

- 3.3.1. The Contractor is responsible for the identification of all interference items, their temporary removal, storage, and refitting to the vessel.

**4. PART 4 – PROOF OF PERFORMANCE**

**4.1. Inspection**

- 4.1.1. A visual inspection by the Contractor and TA in attendance, of general workmanship including that of piping, hardware, materials, and coatings must be conducted.
- 4.1.2. All work must be carried out in accordance to Class and Transport Canada requirements as verified by the ABS Class Inspector and the Technical Authority.
- 4.1.3. Refer to Regulations in H-1 General Notes

**4.2. Testing**

- 4.2.1. N/A

**4.3. Certification**

- 4.3.1. Disposal certificate for old material.

**5. PART 5 - DELIVERABLES**

**5.1. Drawings/Reports**

- 5.1.1. The Contractor must produce two (2) electronic PDF copies of a final report for the TA upon completion of the above noted scope of work. The final report must contain the results of all inspections, testing, manufacturer information, part numbers and details of work completed..
- 5.1.2. The Contractor must include all associated documentation related to this specification as described H-1 General Notes - Section 5 - Documentation.

**5.2. Spares**

- 5.2.1. The Contractor must supply one (1) set of spare fenders per region

**5.3. Training**

- 5.3.1. N/A

**5.4. Manuals**

- 5.4.1. N/A

	MLB	
Spec Item #: H-31	SPECIFICATION	
<b>INCLINING AND LIGHTSHIP SURVEY</b>		

**1. PART 1 – SCOPE**

- 1.1.** Refer to Annex A for the statement of work for the Inclining and Lightship Survey and Weight Management Plan details on page 275.

	MLB	
Spec Item #: M-50	SPECIFICATION	
<b>ALARM &amp; MONITORING (REMOTE SYSTEM)</b>		

## 1. PART 1 - SCOPE

- 1.1.** The intent of this specification item is for the Contractor to provide and install new upgraded components to the MarineNav Engine and Vessel Monitoring system
- 1.2.** The Engine Room Alarm and Vessel Monitoring System parts must be replaced with MarineNav's new and current Monitoring system hardware and parts and must also include the latest software and firmware revisions.

## 2. PART 2 – REFERENCES

### 2.1. Guidance Drawings/Nameplate Data

- 2.1.1. Drawing Number 47B MLB 252-020 – Propulsion Control System
- 2.1.2. Drawing Number 47B MLB 252-020 – Engine Remote Shutdown
- 2.1.3. Drawing Number 47B MLB 300-020 – Electrical One Line Diagram
- 2.1.4. Drawing Number 47B MLB 436-017 – Control and Alarm Systems

### 2.2. Standards

- 2.2.1. See H-1 General Notes

### 2.3. Regulations

- 2.3.1. See H-1 General Notes

### 2.4. Government Furnished Material

- 2.4.1. N/A

### 2.5. Contractor Furnished Material

- 2.5.1. The Contractor must supply everything that is required to perform the specified work unless otherwise stated, such as but not limited to the following: labour, materials, parts, tools, consumables, equipment, machinery, storage, shelters, staging, rigging, scaffolding, enclosures, power and heating. must
- 2.5.2. The Vessel's Alarm Monitoring System AVM Computer System w/ 12" Display must be replaced with MarineNav Part #: SYP-AVM-001
- 2.5.3. The Vessel's Alarm Monitoring System - Alarm Acknowledge Button must be replaced with MarineNav Part #: SYP-AVM-ACK
- 2.5.4. The Vessel's Alarm Monitoring System Data Backup & Restore Kit must be replaced with MarineNav Part #: SYP-AVM-010

- 2.5.5. The Vessel's Alarm Monitoring System BNC Splitter must be replaced with MarineNav Part #: SYP-AVM-BNC
- 2.5.6. The Vessel's Alarm Monitoring System Buzzer must be Replace with MarineNav Part #: SYP-AVM-BUZZER
- 2.5.7. The Vessel's Alarm Monitoring System Engine Room Camera must be replaced with MarineNav Part #: SYP-AVM-CAM
- 2.5.8. The Vessel's Alarm Monitoring System CO Detector must be replaced with MarineNav Part #: SYP-AVM-CO
- 2.5.9. The Vessel's Alarm Monitoring System Horn must be replaced with MarineNav Part #: SYP-AVM-HORN
- 2.5.10. The Vessel's Alarm Monitoring System GPS/Satellite Position Integrated Receiver must be replaced with MarineNav Part # SYP-AVM-GPS-SAT
- 2.5.11. The Vessel's must be equipped with AVM Wireless Monitoring Tablet MarineNav Part # SYP-AVM-TAB
- 2.5.12. The Vessel's Alarm Monitoring System Ethernet to Wireless Cellular Modem must be replaced with MarineNav Part# SYP-AVM-MODEM
- 2.5.13. The Vessel's Alarm Monitoring System Engine Room Camera must be replace with Pan/tilt/Zoom Camera. MarineNav Part # SYP-AVM-CAM-PTZ
- 2.5.14. The Vessel's Alarm Monitoring System must run Windows 10 Pro-64 Licence Key with Disc, MarineNav Part# SYP-SOFT-OS-WIN10PRO-64
- 2.5.15. The Vessel's MarineNav Enclosed Bridge display must be replaced with MarineNav part # CG-ELITE-12
- 2.5.16. The Vessel's MarineNav Open Bridge display must be replaced with MarineNav part # CG-ELITE-12
- 2.5.17. All supplied and installed equipment must be certified by the RO.

### **3. PART 3 – TECHNICAL DESCRIPTION**

#### **3.1. General**

- 3.1.1. The Contractor must ensure prior to any work commencing that both the Contractor Basic Safety Familiarization and Pre Job Safety Assessment are completed and signed off.
- 3.1.2. The Contractor must ensure all Purchase Orders are reviewed by the Technical Authority prior must being issued to the supplier.
- 3.1.3. The Contractor must remove all existing MarineNav equipment from the vessel, taking care not to damage existing wiring, and protecting it for reuse.

- 3.1.4. Care must be taken not to damage any painted surfaces, wiring and mounting brackets.
- 3.1.5. Any damage caused by the Contractor must be repaired to original condition.
- 3.1.6. All removed equipment must be treated as Class A, and shipped to a location decided upon by the TA. Shipping costs will be via PSPC 1379 action.
- 3.1.7. The Contractor must install the new MarineNav equipment listed in Section 2.5 using existing wiring and mounting hardware unless damage is found. Any damage to the wiring will be treated as work arising via PSPC 1379 action.
- 3.1.8. Installation of the new MarineNav equipment must be done in conjunction with the installation of the new main engines.

### **3.2. Location**

- 3.2.1. Open bridge, Enclosed Wheelhouse, Engine Room, Survivors Compartment

### **3.3. Interferences**

- 3.3.1. The Contractor is responsible for the identification of all interference items, their temporary removal, storage, and refitting to the vessel.

## **4. PART 4 – PROOF OF PERFORMANCE**

### **4.1. Inspection**

- 4.1.1. All work must be carried in accordance to Class and Transport Canada requirements as verified by the ABS Class Inspector and the Technical Authority
- 4.1.2. A visual verification inspection by the Contractor, MarineNav Technician and CGTA in attendance, of general workmanship including that of installation, hardware, materials, and coatings must be conducted.
- 4.1.3. Refer to Regulations in H-1 General Notes

### **4.2. Testing**

- 4.2.1. The Contractor and MarineNav Representative, after installation of the engines, must verify the activation, silence, and acknowledge function of each alarm point, each alarm monitor, and each alarm annunciator on each vessel. The Contractor must deliver to the TA, in writing the alarm test results complete with system alarm point, test alarm reading, time of the test, and name of the person conducting the test. The Contractor must demonstrate to the TA the function of the alarm system after this verification and before acceptance.
- 4.2.2. Where components fail during testing, they will be replaced via PSPC 1379 action.
- 4.2.3. The Contractor must conduct all specified testing and notify the Technical Authority and ABS Class Inspector of the schedule for the testing and inspection.

4.2.4. The ABS Class Inspector and the Technical Authority must witness all specified testing.

**4.3. Certification**

4.3.1. Refer to Regulations in H-1 General Notes

**5. PART 5 – DELIVERABLES**

**5.1. Drawings/Reports**

5.1.1. The Contractor must produce two (2) electronic PDF copies of a final report for the TA upon completion of the above noted scope of work. The final report must contain the results of all inspections, testing, manufacturer information, part numbers and details of work completed..

5.1.2. The Contractor must include all associated documentation related to this specification as described H-1 General Notes - Section 5 – Documentation.

5.1.3. The Contractor must provide new As-Fitted Drawings as per H-1 General Notes Section 6 - Drawings

**5.2. Spares**

5.2.1. Any remaining spare parts that were purchased, but not used, for this specification must be supplied to the TA for onboard spares.

**5.3. Training**

5.3.1. N/A

**5.4. Manuals**

5.4.1. The Contractor must include all associated manuals related to this specification as described in H-1 General Notes - Section 7 – Manuals.

	MLB	
Spec Item #: M-51	SPECIFICATION	
REPLACE MANUAL FIRE PUMP		

## 1. PART 1 - SCOPE

- 1.1. The intent of this specification is to replace the manual fire pump
- 1.2. This work must be carried out in conjunction with:
- H-22 AI Renewal in Aft Buoyancy Compartments and Fwd Deck Lockers
  - H-14 Replace Through Hull Connections
  - H-23 Replace S/W Piping

## 2. PART 2 – REFERENCES

### 2.1. Guidance Drawings/Nameplate Data

- 2.1.1. Drawing Number 47B MLB 505-040 – Piping, Hull Fire Pump, Hand Operated
- 2.1.2. Drawing Number 47B MLB 150-090 – Aft Buoyancy Box
- 2.1.3. Drawing Number 47B MLB 521-010 – Dewatering Pump Arrangement and Details

### 2.2. Standards

- 2.2.1. See General Notes H-1

### 2.3. Regulations

- 2.3.1. See General Notes H-1

### 2.4. Government Furnished Material

- 2.4.1. N/A

### 2.5. Contractor Furnished Material

- 2.5.1. The Contractor must supply everything that is required to perform the specified work unless otherwise stated, such as but not limited to the following: labour, materials, parts, tools, consumables, equipment, machinery, storage, shelters, staging, rigging, scaffolding, enclosures, power and heating. must
- 2.5.2. Existing pump is a Whale Gusher Pump model 3020
- 2.5.3. Refer to Appendix A for List of Original Suppliers or Appendix B for List of Alternate/Additional Suppliers
- 2.5.4. All supplied and installed equipment must be certified by the RO.

## 3. PART 3 – TECHNICAL DESCRIPTION

### 3.1. General



- 3.1.1. The Contractor must ensure prior to any work commencing that both the Contractor Basic Safety Familiarization and Pre Job Safety Assessment are completed and signed off.
- 3.1.2. The Contractor must disconnect the existing pump and remove from the space (Stbd. Buoyancy tank aft).
- 3.1.3. The Contractor must hand tool clean the areas exposed by the pump and handle removal and prepare for inspection by the Technical Authority.
- 3.1.4. The Contractor must supply and install new pump and handle of the same make and model as currently fitted.
- 3.1.5. The Contractor must demonstrate the operation of the new pump to the Technical Authority.

**3.2. Location**

- 3.2.1. Starboard after buoyancy tank and starboard after deck.

**3.3. Interferences**

- 3.3.1. The Contractor is responsible for the identification of all interference items, their temporary removal, storage, and refitting to the vessel.

**4. PART 4 – PROOF OF PERFORMANCE**

**4.1. Inspection**

- 4.1.1. A visual inspection by the Contractor and TA in attendance, of general workmanship including that of piping, hardware, materials, and coatings must be conducted.
- 4.1.2. All work must be carried out in accordance to Class and Transport Canada requirements as verified by the ABS Class Inspector and the Technical Authority.
- 4.1.3. Refer to Regulations in H-1 General Notes.

**4.2. Testing**

- 4.2.1. The Contractor must function test the pump and show the system is free of leaks. The Contractor must repair any deficiencies and re-test.
- 4.2.2. The Contractor must conduct all specified testing and notify the Technical Authority of the schedule for the testing and inspection.
- 4.2.3. The Technical Authority must witness all specified testing.

**4.3. Certification**

- 4.3.1. N/A

**5. PART 5 – DELIVERABLES**

**5.1. Drawings/Reports**

5.1.1. The Contractor must produce two (2) electronic PDF copies of a final report for the TA upon completion of the above noted scope of work. The final report must contain the results of all inspections, testing, manufacturer information, part numbers and details of work completed..

5.1.2. The Contractor must include all associated documentation related to this specification as described H-1 General Notes - Section 5 - Documentation.

**5.2. Spares**

5.2.1. N/A

**5.3. Training**

5.3.1. N/A

**5.4. Manuals**

5.4.1. The Contractor must supply two Bi-lingual English-French manuals to the Technical Authority as described in H-1 General Notes - Section 7 - Manuals.

	MLB	
Spec Item #: M-52	SPECIFICATION	
REPLACE DEWATERING PUMP		

## 1. PART 1 - SCOPE

- 1.1. The intent of the spec is for the Contractor to replace the existing dewatering pump with a CGP1B-GX120 high pressure pump.

## 2. PART 2 – REFERENCES

### 2.1. Guidance Drawings/Nameplate Data

- 2.1.1. N/A

### 2.2. Standards

- 2.2.1. See General Notes H-1

### 2.3. Regulations

- 2.3.1. See General Notes H-1

### 2.4. Government Furnished Material

- 2.4.1. N/A

### 2.5. Contractor Furnished Material

- 2.5.1. The Contractor must supply everything that is required to perform the specified work unless otherwise stated, such as but not limited to the following: labour, materials, parts, tools, consumables, equipment, machinery, storage, shelters, staging, rigging, scaffolding, enclosures, power and heating. must
- 2.5.2. Refer to Appendix A for List of Original Suppliers or Appendix B for List of Alternate/Additional Suppliers.
- 2.5.3. CGP1B-GX120 high pressure pump

## 3. PART 3 – TECHNICAL DESCRIPTION

### 3.1. General

- 3.1.1. The Contractor must ensure prior to any work commencing that both the Contractor Basic Safety Familiarization and Pre Job Safety Assessment are completed and signed off
- 3.1.2. The contractor must remove the existing dewatering pump and drum that contains it from the vessel. The pump and drum must be treated as Class A material.
- 3.1.3. The Contractor must supply a new CGP1B-GX120 high pressure pump with A528 drum.
- 3.1.4. The drum must be fitted with a rubber gasket and a hand operated locking ring.
- 3.1.5. The drum must also have handles, similar to the original, for portability.

### 3.2. Location

- 3.2.1. Stern of vessel, main deck

**3.3. Interferences**

- 3.3.1. The Contractor is responsible for the identification of all interference items, their temporary removal, secure storage, and refitting to the vessel.

**4. PART 4 – PROOF OF PERFORMANCE**

**4.1. Inspection**

- 4.1.1. A visual inspection by the Contractor and TA in attendance, of general workmanship including that of piping, hardware, materials, and coatings must be conducted.

**4.2. Testing**

- 4.2.1. N/A

**4.3. Certification**

- 4.3.1. Refer to Regulations in H-1 General Notes.

**5. PART 5 - DELIVERABLES**

**5.1. Drawings/Reports**

- 5.1.1. The Contractor must produce two (2) electronic PDF copies of a final report for the TA upon completion of the above noted scope of work. The final report must contain the results of all inspections, testing, manufacturer information, part numbers and details of work completed..
- 5.1.2. The Contractor must include all associated documentation related to this specification as described H-1 General Notes - Section 5 - Documentation.
- 5.1.3. If any alterations from the original drawings have been made, the Contractor must include revised as fitted drawings as described in H-1 General Notes - Section 6 - Drawings.

**5.2. Spares**

- 5.2.1. N/A

**5.3. Training**

- 5.3.1. N/A

**5.4. Manuals**

- 5.4.1. Contractor must include all associated manuals related to this specification as described in H-1 General Notes - Section 7 - Manuals

	MLB	
Spec Item #: M-53	SPECIFICATION	
REPLACE MAIN ENGINES		

## 1. PART 1: SCOPE:

- 1.1.** The Canadian Coast Guard operate a fleet of thirty six (36) Motorized Life Boats. Thirty one of these vessels are fitted with the out of production Caterpillar 3196 diesel engines and five with its replacement model the Caterpillar C-12 diesel engine. The vessels are built as a class and designed to accommodate both engines with minimal modifications to the vessel or to its control and monitoring systems.
- 1.2.** The intent of this specification is to remove the existing Caterpillar 3196 engines, gearboxes, controls and monitoring systems and to replace with new contractor supplied Caterpillar C-12 diesel marine propulsion engines, gearboxes, controls and monitoring systems.

## 2. PART 2: REFERENCES:

### 2.1. Guidance Drawings/Nameplate Data

- 2.1.1. Drawing Number 47B MLB 201-010 – Machinery Arrangement
- 2.1.2. Drawing Number 47B MLB 259-020 – Engine Exhaust Arrangement
- 2.1.3. Drawing Number 47B MLB 180-010 – Foundation Booklet
- 2.1.4. Drawing Number 47B MLB 505-022 – Piping, Hull (SW Cooling)
- 2.1.5. Drawing Number 47B MLB 505-024 – Piping, Hull (Fuel Oil System)
- 2.1.6. Drawing Number 47B MLB 110-100 – Main Deck (soft patches)
- 2.1.7. Drawing Number 47B MLB 252-010 – Propulsion Control System
- 2.1.8. Drawing Number 47B MLB 252-020 – Engine Remote Shutdown
- 2.1.9. Drawing Number 47B MLB 243-010 – Propeller, Shafting, Bearings and Seals

### 2.2. Standards

- 2.2.1. See General Notes H-1

### 2.3. Regulations

- 2.3.1. See General Notes H-1

### 2.4. Government Furnished Material

- 2.4.1. NA

### 2.5. Contractor Furnished Material

- 2.5.1. The contractor shall supply all: materials, equipment, labor, including staging, rigging, scaffolding, enclosures, heating, painting equipment and parts required to perform the specified work unless otherwise stated.

- 2.5.2. The Contractor supplied engine must be a Caterpillar C-12 de-rated to 450 BHP or equivalent. Where a contractor proposes an equivalent engine it must fully describe the equivalent engine and any required changes to the vessel to accommodate the alternate engine.
- 2.5.3. The Contractor supplied gearboxes must be Twin Disc MG5114RV or equivalent. One with clockwise output shaft rotation and one with counter clockwise output shaft rotation. Where a contractor proposes an equivalent gearbox it must fully describe the equivalent gearbox and any required changes to the vessel to accommodate the alternate gearbox.
- 2.5.4. The Contractor supplied controls must be Twin Disc EC300 Marine Control System or equivalent. Where a contractor proposes an equivalent control system it must fully describe the equivalent control system and any required changes to the vessel to accommodate the alternate control system.
- 2.5.5. The proposal must address measures required to maintain the vessels existing performance and classification. The contractor will have total system responsibility to deliver vessels meeting the existing performance and classification. The contractor must include in their proposal all costs for the supply and fitting of the proposed engines and gearboxes and any required modifications. For alternate engines and gearboxes, cost must include replacing the Caterpillar C-12 and Twin Disc MGX5114RV gearboxes already fitted to the five existing vessels, training of two (2) crew members per vessel on the proposed propulsions system, replacement of existing spares inventory (for bid purposes use \$30,000 per vessel), repopulating the Cape Class Maximo maintenance management system (for bid purposes use \$10,000 per vessel) and any other required costs associated with the change of engine and gearbox type.

### **3. Part 3: TECHNICAL DESCRIPTION:**

#### **3.1. General**

- 3.1.1. Contractor to ensure prior to any work commencing that both the Contractor Basic Safety Familiarization and Pre Job Safety Assessment are completed and signed off
- 3.1.2. The Contractor must consult with the engine supplier's FSR and conduct the removal and reinstallation of the DPTS (Diesel Propulsion Train Shipset) in accordance with their directions.
- 3.1.3. The contractor must open access to the engine space by removing the vessels soft patches. Soft patches are to be removed from the vessel and stored for re-installation.
- 3.1.4. Contractor must disconnect the existing engines and gear boxes from the shafting, mounts, wiring, piping, exhausts and any other attachments to prepare the fitted engines to be removed. The Contractor is responsible to repair any Contractor

inflicted damage to the connections, the aluminum framing and any equipment in the space.

- 3.1.5. The contractor must remove the existing shaft line and remove ashore to prepare for shipping to CCG. Cost of shipping will be by 1379 action.
- 3.1.6. The contractor must remove existing control system and engine monitoring system and transport ashore to crate and prepare for shipment to CCG. Cost of shipping will be by 1379 action.
- 3.1.7. The contractor must remove ashore existing DC generators ashore to crate and prepare for shipment to CCG. Cost of shipping will be by 1379 action.
- 3.1.8. Contractor must remove any interference equipment ashore and store in an environment controlled space for re-installation
- 3.1.9. The contractor must remove the existing engines and gear boxes from the vessel. Partial disassembly of the engine is required to remove the engines through the soft patch.
- 3.1.10. The removed engines and gear boxes must be treated as Class A material and crated for shipment to a site identified by the Technical Authority. Any components removed from the engine during the removal must be re-installed on the engine in operating condition and presented to the Technical Authority for acceptance prior to crating. Cost of shipping will be covered by 1379 action.
- 3.1.11. Contractor must clean the emptied space and prepare it for inspection by the Technical Authority and the ABS Class Inspector. Any defects not caused by the Contractor during the removal process will be treated as a work arising.
- 3.1.12. The Contractor must prepare all disconnected fittings and systems for inspection by the Technical Authority and the ABS Class Inspector. Any found defects exposed by the engine removal and not caused by the contractor shall be repaired using the 1379 process.
- 3.1.13. Any modifications required to fit the engines into the MLB, demonstration and testing must be at the Contractors expense.
- 3.1.14. Each gearbox must be fitted with an input shaft belt driven, 290 Amp, 28V DC charging alternator with voltage regulator. Equivalent to Leece-Neville model 2272A, currently fitted, which is no longer in production.
- 3.1.15. The contractor must supply and install a compatible 5kW AC generator to each engine, and connect to the existing wiring.
- 3.1.16. The engines must be fitted with a local gauge panel and emergency stop. Local reading must be tied into the remote gauge panels.
- 3.1.17. The engines must be fitted with a Contractor supplied immersion type jacket water heater, 1000W, 120V, 60 Hz, single-phase, complete with thermostat rated at 120F.

- 3.1.18. The Contractor must paint the gearboxes the same color as the engines prior to installing the gearboxes. The Contractor must touch up and damaged paint on the engines and gearboxes after installation.
- 3.1.19. Any modifications required to fit the engines into the MLB, demonstration and testing will be at the Contractors expense.
- 3.1.20. The Contractor must install the engines and gearboxes in accordance with the manufacturer's instructions and under the direction of the manufacturer's Field Service Representative (FSR) and reattach all connections.
- 3.1.21. The Contractor must present the installed engines and gear boxes for inspection prior to alignment to the FSR, Technical Authority and the ABS Class Inspector.
- 3.1.22. The contractor is to install the shafts and complete all connections in the propulsion driveline.
- 3.1.23. The Contractor must align the engines in accordance with the manufacturer's guidelines and present to Technical Authority and the ABS Class Inspector for verification. Any adjustments are to be to the Contractor's expense.
- 3.1.24. The Contractor must install the new engine controls and monitoring system and make all connections.
- 3.1.25. The Contractor must demonstrate that the engine and gear boxes as fitted are connected with the vessels alarm, monitoring and control systems. Demonstration must be presented to the Technical Authority and the ABS Class Inspector.
- 3.1.26. The Contractor must fill the engines and gear boxes with the manufacturer's liquids and coolants.
- 3.1.27. The contractor must prepare and follow a start-up and trial plan prior to commencing the engine start up and run in under the direct supervision of the engine manufacturer's FSR. The plan is to be presented for review and acceptance by the Technical Authority and the ABS Class Inspector prior to implementing the plan.
- 3.1.28. The Contractor must start up the new engines and gear boxes following the engine manufacturer's FSR instructions and in the presence of the Technical Authority and the ABS Class Inspector.
- 3.1.29. The contractor must verify the operation of all gauges, alarms and shut down settings. The Contractor must correct any deficiencies.
- 3.1.30. The Contractor must carry out a four hour dock trial under the direction of the FSR, and in the presence of Technical Authority and the ABS Class Inspector. Engine speeds and duration of time at each speed must be included in the set up and trial plan.
- 3.1.31. The Contractor, using Contractor supplied fuel and liquids conduct a two hour maneuvering trial followed by a four hour full power sea trial of the engines in the



presence of the FSR, Technical Authority and the ABS Class Inspector. Should the engines require to be reduced from full power for adjustments or other work the full trials must be repeated.

- 3.1.32. On completion of the trial the engines and gear boxes must be inspected for leaks and fluid levels verified. The Contractor must correct any issues and demonstrate the rework to the Technical Authority and the ABS Class Inspector.
- 3.1.33. The contractor must supply all relevant part numbers, serial numbers and maintenance procedures to the TA for entry into Maximo vessel maintenance management software.

### **3.2. Location**

- 3.2.1. Engine Room and Survivors Compartment

### **3.3. Interferences**

- 3.3.1. Contractor is responsible for the identification of all interference items, their temporary removal, secure storage, and refitting to the vessel.

## **4. PART 4: PROOF OF PERFORMANCE:**

### **4.1. Inspection**

- 4.1.1. A visual inspection by the Contractor and TA in attendance, of general workmanship including that of piping, hardware, materials, and coatings must be conducted.
- 4.1.2. All work carried out must be verified correct by the FSR, Technical Authority and the ABS Class Inspector.
- 4.1.3. Refer to Regulations in H-5 General Notes

### **4.2. Testing**

- 4.2.1. The engines and gear boxes must be tested and demonstrated in accordance with the Contractor prepared and Technical Authority and ABS Class Inspector approved test and trial plan described above.

### **4.3. Certification**

- 4.3.1. All supplied and installed equipment must be certified by the RO.

## **5. PART 5: DELIVERABLES:**

### **5.1. Drawings/Reports**

- 5.1.1. The Contractor must produce two (2) electronic PDF copies of a final report for the TA upon completion of the above noted scope of work. The final report must contain the results of all inspections, testing, manufacturer information, part numbers and details of work completed.
- 5.1.2. Contractor must include all associated documentation related to this specification as described H-5 General Notes - Section 5 – Documentation

5.1.3. The Contractor must supply two (2) electronic and two (2) hard copies of class approved as fitted drawings of the engine, gear boxes and connections. Copies must be presented to the Technical Authority as described in H-1 General Notes Section 6 Drawings.

**5.2. Spares**

5.2.1. If an equivalent engine and/or gearbox is chosen, the Contractor must supply spare parts in accordance with section 2.5.5.

**5.3. Training**

5.3.1. The Contractor must supply 24 hours (3 days) of familiarization training, conducted by the engine manufacturer's representative, on the maintenance, operation and troubleshooting of the engines and gear boxes to the Technical Authority and two crew members per vessel at the Contractor's facility.

**5.4. Manuals**

5.4.1. The contractor must provide 3 electronic and 3 hard copies of the engine and gear box manuals. Manuals must be in bi-lingual format French/English as described in H-1 General Notes - Section 7 - Manuals

	MLB	
Spec Item #: M-54	SPECIFICATION	
<b>REPLACE CARBON GROUNDING BRUSH</b>		

## 1. PART 1 - SCOPE

- 1.1. The intent of this specification is to replace the shaft carbon brushes and holders.
- 1.2. This work must be carried out in conjunction with the renewal of the main engine and shaft line.

## 2. PART 2 – REFERENCES

### 2.1. Guidance Drawings/Nameplate Data

- 2.1.1. Drawing Number 47B MLB 633-010 – Cathodic Protection

### 2.2. Standards

- 2.2.1. See General Notes H-1

### 2.3. Regulations

- 2.3.1. See General Notes H-1

### 2.4. Government Furnished Material

- 2.4.1. N/A

### 2.5. Contractor Supplied Material

- 2.5.1. The Contractor must supply everything that is required to perform the specified work unless otherwise stated, such as but not limited to the following: labour, materials, parts, tools, consumables, equipment, machinery, storage, shelters, staging, rigging, scaffolding, enclosures, power and heating.
- 2.5.2. Refer to Appendix A for List of Original Suppliers or Appendix B for List of Alternate/Additional Suppliers
- 2.5.3. All supplied and installed equipment must be certified by the RO.

## 3. PART 3 – TECHNICAL DESCRIPTION

### 3.1. General

- 3.1.1. The Contractor must ensure prior to any work commencing that both the Contractor Basic Safety Familiarization and Pre Job Safety Assessment are completed and signed off.
- 3.1.2. The Contractor must disconnect the existing brush holders, hand tool clean and prepare for reinstallation after new shaft is installed.
- 3.1.3. The Contractor must disconnect the existing brushes and give to the Technical Authority.

- 3.1.4. The Contractor must reinstall the brush holder after the shaft installation.
- 3.1.5. The Contractor must supply and install the new brushes, ensure their freedom of motion in the holder and contact with the shaft.

**3.2. Location**

- 3.2.1. Survivors Compartment

**3.3. Interferences**

- 3.3.1. Contractor is responsible for the identification of all interference items, their temporary removal, storage, and refitting to the vessel.

**4. PART 4 – PROOF OF PERFORMANCE**

**4.1. Inspection**

- 4.1.1. A visual inspection by the Contractor and TA in attendance, of general workmanship including that of piping, hardware, materials, and coatings must be conducted.

**4.2. Testing**

- 4.2.1. The Contractor must verify contact with the shaft and freedom of motion in the holder.
- 4.2.2. The Technical Authority must witness all testing.

**4.3. Certification**

- 4.3.1. N/A

**5. PART 5 - DELIVERABLES**

**5.1. Drawings/Reports**

- 5.1.1. The Contractor must produce two (2) electronic PDF copies of a final report for the TA upon completion of the above noted scope of work. The final report must contain the results of all inspections, testing, manufacturer information, part numbers and details of work completed..
- 5.1.2. The Contractor must include all associated documentation related to this specification as described H-1 General Notes - Section 5 - Documentation.

**5.2. Spares**

- 5.2.1. N/A

**5.3. Training**

- 5.3.1. N/A

**5.4. Manuals**

- 6. N/A

	MLB	
Spec Item #: M-55	SPECIFICATION	
REPLACE RUDDERS		

### 1. PART 1: SCOPE:

- 1.1. The intent of this spec is to remove the existing rudders and replace with new contractor supplied rudders of the same design, materials and quality.

### 2. PART 2: REFERENCES:

#### 2.1. Guidance Drawings/Nameplate Data

- 2.1.1. Drawing Number 47B MLB 561-020 – Rudder Arrangement  
 2.1.2. Drawing Number 47B MLB 562-010 – Rudder Construction  
 2.1.3. Drawing Number 47B MLB 201-010 – Machinery Arrangement  
 2.1.4. Drawing Number 47B MLB 561-010 – Steering Gear and Control  
 2.1.5. Drawing Number 47B MLB 180-010 - Foundation Booklet

#### 2.2. Standards

- 2.2.1. See General Notes H-1

#### 2.3. Regulations

- 2.3.1. See General Notes H-1

#### 2.4. Government Furnished Material

- 2.4.1. N/A

#### 2.5. Contractor Furnished Material

- 2.5.1. The Contractor must supply everything that is required to perform the specified work unless otherwise stated, such as but not limited to the following: labour, materials, parts, tools, consumables, equipment, machinery, storage, shelters, staging, rigging, scaffolding, enclosures, power and heating.
- 2.5.2. Refer to Appendix A for List of Original Suppliers or Appendix B for List of Alternate/Additional Suppliers.
- 2.5.3. All supplied and installed equipment must be certified by the RO.

### 3. PART 3: TECHNICAL DESCRIPTION:

#### 3.1. General

- 3.1.1. The Contractor must ensure prior to any work commencing that both the Contractor Basic Safety Familiarization and Pre Job Safety Assessment are completed and signed off.
- 3.1.2. The Contractor must remove the two existing rudders using care to not damage the stern post connections.

- 3.1.3. The Contractor must remove the old rudders ashore and crate for shipment to CCG. Shipping charges will be treated as additional work and processed via PSPC 1379 action.
- 3.1.4. The Contractor must clean and inspect the rudder attachment and present to the Technical Authority and ABS inspector for inspection. Defects will be repaired via PSPC 1379 action and presented for re-inspection.
- 3.1.5. The Contractor must fabricate replacement rudders and cover plates of the same material and design as existing rudders as per the drawings. Contractor must ensure fairing of the welds at the trailing edge does not impede the strength of the welds.
- 3.1.6. The Contractor must engage the services of an NDT specialist to conduct 100% x-rays of the welds. Copies of the X-rays must be presented to the Technical Authority and ABS inspector for review. Defects must be corrected at the Contractor's expense and X-rayed.
- 3.1.7. Rudder must be pressure tested to 2 PSI and the pressure held for one (1) hour. Test must be presented to the Technical Authority and ABS inspector for review. Defects must be corrected at the Contractor's expense and re X-rayed.
- 3.1.8. The Contractor must re-install the rudder using new contractor supplied bearings, bolts, lock washers and nuts of the same size and material of that removed.
- 3.1.9. The Contractor must use torque values indicated in the drawings.
- 3.1.10. The Contractor must verify the function of the rudders to the Technical Authority and ABS inspector.

**3.2. Location**

- 3.2.1. Stern underwater.

**3.3. Interferences**

- 3.3.1. Contractor is responsible for the identification of all interference items, their temporary removal, secure storage, and refitting to the vessel.

**4. PART 4: PROOF OF PERFORMANCE:**

**4.1. Inspection**

- 4.1.1. A visual inspection by the Contractor and TA in attendance, of general workmanship including that of piping, hardware, materials, and coatings must be conducted.
- 4.1.2. All work must be carried out must be verified correct and approved by the Technical Authority and ABS Inspector.

**4.2. Testing**

- 4.2.1. The Contractor must demonstrate all functions of the rudders to the Technical Authority and ABS Inspector. The Contractor must correct any deficiencies found and retest.
- 4.2.2. The Contractor must hydrostatically test each new rudder.

**4.3. Certification**

4.3.1. The fitted rudders must be approved by the ABS Inspector and certification provided.

**5. PART 5: DELIVERABLES:**

**5.1. Drawings/Reports**

5.1.1. The Contractor must produce two (2) electronic PDF copies of a final report for the TA upon completion of the above noted scope of work. The final report must contain the results of all inspections, testing, manufacturer information, part numbers and details of work completed..

5.1.2. The Contractor must supply the Technical Authority with three electronic copies of drawing of the rudders and installation. See H-1 General Notes Section 6 Drawings.

5.1.3. The Contractor must include all associated documentation related to this specification as described H-1 General Notes - Section 5 - Documentation.

**5.2. Spares**

5.2.1. N/A

**5.3. Training**

5.3.1. N/A

**5.4. Manuals**

5.4.1. N/A

	MLB	
Spec Item #: M-56	SPECIFICATION	
<b>REPLACE PROPELLER SHAFTS AND COUPLING FLANGES</b>		

## 1. PART 1 - SCOPE

- 1.1. The intent of this specification is to replace the two (2) tail shafts, including all components from the propeller nuts to the drive saver couplings, with new, as per original drawings.
- 1.2. This work must be carried out in conjunction with the Stern Tube Replacement, Rudder Replacement and Engine Gear Box Replacement.

## 2. PART 2 – REFERENCES

### 2.1. Guidance Drawings/Nameplate Data

- 2.1.1. Drawing Number 47B MLB 243-010 – Propeller, Shafting, Bearings and Seals

### 2.2. Standards

- 2.2.1. See General Notes H-1

### 2.3. Regulations

- 2.3.1. See General Notes H-1

### 2.4. Government Furnished Material

- 2.4.1. N/A

### 2.5. Contractor Furnished Material

- 2.5.1. The Contractor must supply everything that is required to perform the specified work unless otherwise stated, such as but not limited to the following: labour, materials, parts, tools, consumables, equipment, machinery, storage, shelters, staging, rigging, scaffolding, enclosures, power and heating.
- 2.5.2. Refer to Appendix A for List of Original Suppliers or Appendix B for List of Alternate/Additional Suppliers.
- 2.5.3. All supplied and installed equipment must be certified by the RO and is the responsibility of the Contractor.
- 2.5.4. The items to be supplied by the Contractor include:
- 2.5.4.1. Propeller nut, Bronze
  - 2.5.4.2. Jam nut, Bronze
  - 2.5.4.3. Cotter Pin, Stainless Steel
  - 2.5.4.4. Propeller Key
  - 2.5.4.5. Complete Rope Cutter Assembly



- 2.5.4.6. 2 ½” Propeller Shaft, Aquamet 22
- 2.5.4.7. Strut Shaft Bearing
- 2.5.4.8. Sterntube Shaft Bearing
- 2.5.4.9. PSS 2.5 400 Shaft Seal
- 2.5.4.10. Coupling Flange
- 2.5.4.11. Coupling Key
- 2.5.4.12. Coupling Bolt
- 2.5.4.13. Drivesaver Coupling

\*Note: The Contractor is to supply two (2) of each item listed. All details can be found on Drawing Number 47B MLB 243-010 – Propeller, Shafting, Bearings and Seals

### **3. PART 3 – TECHNICAL DESCRIPTION**

#### **3.1. General**

- 3.1.1. The Contractor must ensure prior to any work commencing, that both the Contractor Basic Safety Familiarization and Pre Job Safety Assessment are completed and signed off.
- 3.1.2. The Contractor must remove the existing propeller nuts, cotter pins and propellers from the vessel. The Contractor must protect and store the propellers for reuse.
- 3.1.3. The Contractor must disconnect the propeller shafts at the forward end and remove the drivesavers and coupling flanges.
- 3.1.4. The Contractor must remove the shaft anodes, as part of H-5 Sacrificial Anodes, and remove the rope cutter assemblies from the vessel.
- 3.1.5. The Contractor must remove the shafts from the vessel and treat them as Class A material.
- 3.1.6. The Contractor must remove the shaft bearings from the struts and sterntubes.
- 3.1.7. All shafting components must be crated and prepared for shipment to a location designated by the CGTA. This shall be done via 1379 action.
- 3.1.8. The new shafts must not be installed until after the completion of H-15 Replace Stern Tubes.
- 3.1.9. The Contractor must supply and install all of the items listed in 2.5.4.
- 3.1.10. The Contractor must use the torque values listed in Drawing Number 47B MLB 243-010 – Propeller, Shafting, Bearings and Seals.

- 3.1.11. The Contractor must include the cost of verifying the fit of the propeller to the shaft taper. Fit of the propeller to the taper and hardening up of the propeller nuts must be witnessed by the Technical Authority and the ABS Inspector.
- 3.1.12. Upon completion of installation the Technical Authority must inspect the installation and locking mechanism. Any defects must be corrected and presented for re-inspection

**3.2. Location**

- 3.2.1. Vessel stern, survivors compartment

**3.3. Interferences**

- 3.3.1. The Contractor is responsible for the identification of all interference items, their temporary removal, storage, and refitting to the vessel.

**4. PART 4 – PROOF OF PERFORMANCE**

**4.1. Inspection**

- 4.1.1. A visual inspection by the Contractor and TA in attendance, of general workmanship including that of piping, hardware, materials, and coatings must be conducted.
- 4.1.2. All work must be carried out in accordance to the RO and Transport Canada requirements as verified and approved by the ABS Class Inspector and the Technical Authority.

**4.2. Testing**

- 4.2.1. The Contractor must conduct all specified testing and notify the Technical Authority and ABS Inspector of the schedule for the testing and inspection.

**4.3. Certification**

- 4.3.1. The Contractor must provide the certification documentation to the Technical Authority.

**5. PART 5 – DELIVERABLES**

**5.1. Drawings/Reports**

- 5.1.1. The Contractor must produce two (2) electronic PDF copies of a final report for the TA upon completion of the above noted scope of work. The final report must contain the results of all inspections, testing, manufacturer information, part numbers and details of work completed..
- 5.1.2. The Contractor must include all associated documentation related to this specification as described H-1 General Notes - Section 5 - Documentation.

**5.2. Spares**

5.2.1. N/A

**5.3. Training**

5.3.1. N/A

**5.4. Manuals**

5.4.1. N/A

	MLB	
Spec Item #: M-57	SPECIFICATION	
<b>INSPECT EXHAUST COMPONENTS</b>		

## **1. PART 1 - SCOPE**

- 1.1.** The intent of this spec is to remove existing exhaust system insulation and conduct a thorough inspection of the metallic components, repair and to reinsulate. Repairs if required will be via PSPC 1379 action.

## **2. PART 2 – REFERENCES**

### **2.1. Guidance Drawings/Nameplate Data**

- 2.1.1. Drawing Number 47B MLB 259-020 – Exhaust System
- 2.1.2. Drawing Number 47B MLB 201-010 – Machinery Arrangement
- 2.1.3. Drawing Number 47B MLB 110-202 – Transverse Bulkhead #1
- 2.1.4. Drawing Number 47B MLB 505-022 – Piping, Hull (Cooling Water)

### **2.2. Standards**

- 2.2.1. See General Notes H-1

### **2.3. Regulations**

- 2.3.1. See General Notes H-1

### **2.4. Government Furnished Material**

- 2.4.1. N/A

### **2.5. Contractor Furnished Material**

- 2.5.1. The Contractor must supply everything that is required to perform the specified work unless otherwise stated, such as but not limited to the following: labour, materials, parts, tools, consumables, equipment, machinery, storage, shelters, staging, rigging, scaffolding, enclosures, power and heating.
- 2.5.2. Refer to Appendix A for List of Original Suppliers or Appendix B for List of Alternate/Additional Suppliers.
- 2.5.3. All supplied and installed equipment must be certified by the RO.

## **3. PART 3 – TECHNICAL DESCRIPTION**

### **3.1. General**

- 3.1.1. The Contractor must ensure prior to any work commencing that both the Contractor Basic Safety Familiarization and Pre Job Safety Assessment are completed and signed off.

- 3.1.2. The Contractor must remove the existing insulation using care to not damage the piping and hangers.
- 3.1.3. The Contractor must dispose of the insulation in accordance with Provincial Regulations in the Contractor's province and provide disposal certificates.
- 3.1.4. The Contractor must supply and install new flexible joints at hull connection.
- 3.1.5. The Contractor must hand tool clean the exhaust piping and inspect for cracks or corrosion.
- 3.1.6. Pipe hangers must be cleaned and inspected for corrosion.
- 3.1.7. Ultrasonic testing must be conducted on the through hull fitting and final section before the hull. Contractor must quote on six ultrasonic shots per side
- 3.1.8. The Contractor must present the cleaned exhaust system to the Technical Authority and ABS Inspector for inspection. Any defects will be repaired via PSPC 1379 action.
- 3.1.9. The Contractor must supply and replace all exhaust system gaskets with gaskets of the same type and quality.
- 3.1.10. The Contractor must reinsulate the exhaust system using the same type, make and rating of insulation.
- 3.1.11. The Contractor must verify the exhaust system is leak free prior to delivery of the vessel.

### **3.2. Location**

- 3.2.1. Engine room

### **3.3. Interferences**

- 3.3.1. The Contractor is responsible for the identification of all interference items, their temporary removal, secure storage, and refitting to the vessel.

## **4. PART 4 – PROOF OF PERFORMANCE**

### **4.1. Inspection**

- 4.1.1. A visual inspection by the Contractor and TA in attendance, of general workmanship including that of piping, hardware, materials, and coatings must be conducted.
- 4.1.2. All work must be carried out must be verified correct and approved by the Technical Authority.

### **4.2. Testing**

- 4.2.1. The Contractor must demonstrate the exhaust is leak free to the Technical Authority and ABS Inspector. The Contractor must correct any deficiencies found and retest.

**4.3. Certification**

4.3.1. N/A

**5. PART 5 – DELIVERABLES**

**5.1. Drawings/Reports**

5.1.1. The Contractor must produce two (2) electronic PDF copies of a final report for the TA upon completion of the above noted scope of work. The final report must contain the results of all inspections, testing, manufacturer information, part numbers and details of work completed..

5.1.2. The Contractor must include all associated documentation related to this specification as described H-1 General Notes - Section 5 - Documentation.

**5.2. Spares**

5.2.1. N/A

**5.3. Training**

5.3.1. N/A

**5.4. Manuals**

5.4.1. N/A

	MLB	
Spec Item #: M-58	SPECIFICATION	
<b>REPLACE STEERING COMPONENTS</b>		

## **1. PART 1 - SCOPE**

- 1.1.** The intent of this specification is to refurbish by replacement the steering system. Refurbishment must include the supply and install of new components to replace the entire system.
- 1.2.** This work must be carried out in conjunction with replacing the steering gear overboard discharge valve, relocation of steering gear header tank and M-55 Rudders.

## **2. PART 2 – REFERENCES**

### **2.1. Guidance Drawings/Nameplate Data**

- 2.1.1. Drawing Number 47B MLB 436-013 – Steering/Autopilot System
- 2.1.2. Drawing Number 47B MLB 561-010 – Piping Arrangements, in Hull (Steering Gear and Controls)
- 2.1.3. Drawing Number 47B MLB 438-010 – Console Arrangement
- 2.1.4. Drawing Number 47B MLB 180-010 – Foundation Booklet
- 2.1.5. Drawing Number 47B MLB 562-010 – Rudder
- 2.1.6. Drawing Number 47B MLB 561-020 – Rudder Arrangement
- 2.1.7. Drawing Number 47B MLB 150-100 – Upper BHD FR 8
- 2.1.8. Drawing Number 47B MLB 110-301 – Web Frame 2

### **2.2. Standards**

- 2.2.1. See General Notes H-1

### **2.3. Regulations**

- 2.3.1. See General Notes H-1

### **2.4. Government Furnished Material**

- 2.4.1. N/A

### **2.5. Contractor Furnished Material**

- 2.5.1. The Contractor must supply everything that is required to perform the specified work unless otherwise stated, such as but not limited to the following: labour, materials, parts, tools, consumables, equipment, machinery, storage, shelters, staging, rigging, scaffolding, enclosures, power and heating.

- 2.5.2. Refer to Appendix A for List of Original Suppliers or Appendix B for List of Alternate/Additional Suppliers
- 2.5.3. All supplied and installed equipment must be certified by the RO.
- 2.5.4. Steering System: Hypromarine Ltd. Mount Pleasant Ln, Sway, Lymington SO41 8LS, United Kingdom
- 2.5.5. Replacement Part List Numbers
- One (1) Helm Unit, 2.75 cubic inch, Part Number HM1099/2.75
  - One (1) Integrated Power Cylinder/Servo/Valve Assembly, Part Number HM1647
  - One (1) Combined Reservoir Assembly, Part Number HM2042
  - Two (2) Parker Gear Pumps, SAE spline shaft 11 tooth 16/32 pitch, 8 cm<sup>3</sup>/rev (0.49 cu in/ rev) displacement Rear SAE ports CW rotation, 2 bolt A flange mount, 3-1/4 pilot, Max press 3625 psi, Max rpm 4000 – verify correct rotation
  - One (1) 18” Diameter Steering Wheel, Stainless Steel Type, Part Number HM1168
  - Three (3) Joystick Assemblies, Part Number HM1973
  - One (1) Feedback Reference Unit, Part Number HM1094
  - One (1) Control Electronics Assembly, Part Number HM2106
  - Two (2) Jog Steering Cancel, Push Button Assemblies, Part Number HM2107
  - Two (2) Display Meters Complete With Gaskets, Part Number HM1096
  - Two (2) Clevis Ends, Stainless Steel Type, Part Number HM2045
  - One (1) Autopilot Pump Assembly, 12 Volt Reversing Type, Part Number HM2072
- 2.5.6. Each shipset of spare parts must consist of the following: items:
- One (1) Seal Kit For Helm Unit HM1099, Part Number HM2138
  - One (1) Seal Kit For Servo Assembly HM1870, Part Number HM1647
  - One (1) Seal Kit For Reservoir Assembly HM2042, Part Number HM2229
  - One (1) Seal Kit For Power Pump HM1886/8, Part Number HM2771
  - One (1) Micro Filter Element, HM1272

### **3. PART 3 – TECHNICAL DESCRIPTION**

#### **3.1. General**

- 3.1.1. The Contractor must ensure prior to any work commencing that both the Contractor Basic Safety Familiarization and Pre Job Safety Assessment are completed and signed off.



- 3.1.2. All removed steering components must be treated as Class A material.
- 3.1.3. The Contractor must dismantle the existing steering gear in the steering compartment and transport ashore for crating and shipping. Cost of shipping must be covered via PSPC 1379 action.
- 3.1.4. The Contractor must remove steering components on the open bridge and in the enclosed bridge and transport ashore for crating and shipping. Cost of shipping must be covered via PSPC 1379 action.
- 3.1.5. The Contractor must disconnect the existing steering pump in the engine compartment and transport ashore for crating and shipping. Cost of shipping must be covered via PSPC 1379 action. Replace with same make and model (Parker Gear Pumps, SAE spline shaft 11 tooth 16/32 pitch, 8 cm<sup>3</sup>/rev (0.49 cu in/ rev) displacement Rear SAE ports CW rotation, 2 bolt A flange mount, 3-1/4 pilot, Max press 3625 psi, Max rpm 4000) NOT Hypomarine.
- 3.1.6. The Contractor must build a new system by supplying and installing replacement components. The installed components must be made up of Hypomarine components, with the exception of the engine driven pump.
- 3.1.7. The Contractor must use existing wiring and piping.
- 3.1.8. The Contractor must verify the wiring and determine it is free of defects. Any defects found will be dealt via PSPC 1379 action.

### **3.2. Location**

- 3.2.1. Wheelhouse and steering compartment.

### **3.3. Interferences**

- 3.3.1. The Contractor is responsible for the identification of all interference items, their temporary removal, storage, and refitting to the vessel.

## **4. PART 4 – PROOF OF PERFORMANCE**

### **4.1. Inspection**

- 4.1.1. A visual inspection by the Contractor and TA in attendance, of general workmanship including that of piping, hardware, materials, and coatings must be conducted.
- 4.1.2. All work must be verified correct by the Technical Authority and the RO Class inspector.

### **4.2. Testing**

- 4.2.1. The Contractor must test the system for leaks in the presence of the Technical Authority and the ABS Inspector. If any leaks are found, the Contractor must repair and test again until proven leak free.
- 4.2.2. The Contractor must operate the system while alongside and demonstrate that the assembled system is leak free and operates in accordance with the Hypomarine

specified performance. Demonstration must be witnessed by the Technical Authority and the ABS Class inspector.

- 4.2.3. The Contractor must trial the steering system at sea during the vessels scheduled sea trials. Testing must include a demonstration of all functions of the system plus movement of the rudder from hard over to hard over and a turning trial through full 360 degree turns at full speed in both directions. Time for each maneuver must be recorded.
- 4.2.4. Trials must be witnessed and accepted by the Technical Authority and the RO Class Inspector.

#### **4.3. Certification**

- 4.3.1. The Contractor must obtain ABS Certification for the reassembled system.

### **5. PART 5 – DELIVERABLES**

#### **5.1. Drawings/Reports**

- 5.1.1. The Contractor must produce two (2) electronic PDF copies of a final report for the TA upon completion of the above noted scope of work. The final report must contain the results of all inspections, testing, manufacturer information, part numbers and details of work completed..
- 5.1.2. The Contractor must include all associated documentation related to this specification as described H-1 General Notes - Section 5 - Documentation.

#### **5.2. Spares**

- 5.2.1. N/A

#### **5.3. Training**

- 5.3.1. N/A

#### **5.4. Manuals**

- 5.4.1. The Contractor must supply manuals describing the system and include a parts list with part numbers as described in H-1 General Notes - Section 7 – Manuals. Manual must be in bi-lingual format English/French.

	MLB	
Spec Item #: M-59	SPECIFICATION	
<b>MOVE STEERING HEADER TANKS TO THE STEERING COMPARTMENT</b>		

## **1. PART 1 - SCOPE**

- 1.1.** The intent of this spec is to move the existing steering header tank to the forward bulkhead of the steering compart. The work must be conducted to coincide with the rebuild of the steering gear.

## **2. PART 2 – REFERENCES**

### **2.1. Guidance Drawings/Nameplate Data**

- 2.1.1. Drawing Number 47B MLB 561-010 – Piping Arrangements, in Hull (Steering Gear and Controls)

### **2.2. Standards**

- 2.2.1. See General Notes H-1

### **2.3. Regulations**

- 2.3.1. See General Notes H-1

### **2.4. Government Furnished Material**

- 2.4.1. N/A

### **2.5. Contractor Furnished Material**

- 2.5.1. The Contractor must supply everything that is required to perform the specified work unless otherwise stated, such as but not limited to the following: labour, materials, parts, tools, consumables, equipment, machinery, storage, shelters, staging, rigging, scaffolding, enclosures, power and heating.
- 2.5.2. Refer to Appendix A for List of Original Suppliers or Appendix B for List of Alternate/Additional Suppliers.
- 2.5.3. All supplied and installed equipment must be certified by Transport Canada and ABS.

## **3. PART 3 – TECHNICAL DESCRIPTION**

### **3.1. General**

- 3.1.1. The Contractor must ensure prior to any work commencing, that both the Contractor Basic Safety Familiarization and Pre Job Safety Assessment are completed and signed off.
- 3.1.2. The Contractor must remove the steering gear header tank currently located on the starboard side of the engine room for relocation to a spot on the forward bulkhead of the steering compartment. Technical Authority must approve the new location.

- 3.1.3. The Contractor must remove the piping leading to and from the steering compartment to the old tank location.
- 3.1.4. The Contractor must remove the mounting brackets and any pipe hanger in the engine room and repaint where the disturbed spots. Paint must match the existing paint scheme in the area.
- 3.1.5. The Contractor must fabricate new mounting brackets for attaching tank to the bulkhead.
- 3.1.6. The Contractor must weld the mounting brackets to the bulkhead and paint the disturbed area using the same painting scheme as the surrounding space.
- 3.1.7. In conjunction with the other work in the steering gear (M-58) the Contractor must fabricate new piping and connect to the steering gear and header tank.

**3.2. Location**

- 3.2.1. Engine room and steering compartment.

**3.3. Interferences**

- 3.3.1. The Contractor is responsible for the identification of all interference items, their temporary removal, secure storage, and refitting to the vessel.

**4. PART 4 – PROOF OF PERFORMANCE**

**4.1. Inspection**

- 4.1.1. A visual inspection by the Contractor and TA in attendance, of general workmanship including that of piping, hardware, materials, and coatings must be conducted.
- 4.1.2. Installation must be presented to the Technical Authority ABS Inspector for inspection and acceptance. Completed work must meet the requirements of TC Marine Safety.

**4.2. Testing**

- 4.2.1. The Contractor must charge the system and demonstrate system is free of leaks to the Technical Authority and ABS Inspector. Testing must be synchronous with the other work in the steering gear M-58. Any leaks or defects must be repaired and retested.
- 4.2.2. The Contractor must demonstrate all functions of the steering system to the Technical Authority and the attending ABS Class inspector. The Contractor must correct any deficiencies found and retest the system.

**4.3. Certification**

- 4.3.1. N/A

**5. PART 5 – DELIVERABLES**

**5.1. Drawings/Reports**

5.1.1. The Contractor must produce two (2) electronic PDF copies of a final report for the TA upon completion of the above noted scope of work. The final report must contain the results of all inspections, testing, manufacturer information, part numbers and details of work completed..

5.1.2. The Contractor must include all associated documentation related to this specification as described H-1 General Notes - Section 5 – Documentation.

5.1.3. See H-1 General Notes Section 6 Drawings

**5.2. Spares**

5.2.1. N/A

**5.3. Training**

5.3.1. N/A

**5.4. Manuals**

5.4.1. N/A

	MLB	
Spec Item #: M-60	SPECIFICATION	
REPLACE HVAC UNITS		

## 1. PART 1 - SCOPE

- 1.1. The intent of this specification must be for the Contractor to replace the HVAC Units with a new contractor supplied units
- 1.2. This work must be carried out in conjunction with the following specification items:  
M-61 Replace HVAC Cooling pumps  
H-23 Replace Seawater Piping

## 2. PART 2 - REFERENCES

### 2.1. Guidance Drawings/Nameplate Data

- 2.1.1. Drawing Number 47B MLB 512-010 – HVAC Details
- 2.1.2. Drawing Number 47B MLB 150-070 – Consoles, Structure
- 2.1.3. Drawing Number 47B MLB 513-010 – Machinery Space Vent
- 2.1.4. Drawing Number 47B MLB 505-010 – Machinery and Piping Insulation Schedule
- 2.1.5. Drawing Number 47B MLB 160-010 – Structural Built in Ventilation Duct
- 2.1.6. Drawing Number 47B MLB 600-010 – Outfit and Furnishings
- 2.1.7. Drawing Number 47B MLB 505-020 – Piping Arrangement, In Hull

### 2.2. Standards

- 2.2.1. See General Notes H-1

### 2.3. Regulations

- 2.3.1. See General Notes H-1

### 2.4. Government Furnished Material

- 2.4.1. N/A

### 2.5. Contractor Furnished Material

- 2.5.1. The Contractor must supply everything that is required to perform the specified work unless otherwise stated, such as but not limited to the following: labour, materials, parts, tools, consumables, equipment, machinery, storage, shelters, staging, rigging, scaffolding, enclosures, power and heating.
- 2.5.2. Two (2) Flagship Marine FMAC16R HVAC units
- 2.5.3. Refer to Appendix A for List of Original Suppliers or Appendix B for List of Alternate/Additional Suppliers.
- 2.5.4. All supplied and installed equipment must be certified by RO.

## 3. PART 3 – TECHNICAL DESCRIPTION

**3.1. General**

- 3.1.1. The existing HVAC Units located in the Survivor Space and in the Enclosed Wheelhouse space must be disconnected and removed from the vessel and returned to the Technical Authority.
- 3.1.2. The Contractor must supply and install Two (2) Flagship Marine FMAC16R HVAC units, or equivalent.
- 3.1.3. The Contractor must install the two (2) new HVAC Units in the same location as the existing HVAC Units using new attachment materials.
- 3.1.4. Any disturbed aluminum work or insulation must be coated as per the paint scheme in the area.
- 3.1.5. All work must be carried out must must be verified and approved by the Technical Authority.

**3.2. Location**

- 3.2.1. Survivor Space and in the Enclosed Wheelhouse

**3.3. Interferences**

- 3.3.1. Contractor is responsible for the identification of interference items, their temporary removal, storing and refitting on the vessel.

**4. PART 4 – PROOF OF PERFORMANCE**

**4.1. Inspection**

- 4.1.1. A visual inspection by the Contractor and TA in attendance, of general workmanship including that of piping, hardware, materials, and coatings must be conducted.
- 4.1.2. All work must be completed to the satisfaction of the Technical Authority and ABS Class Surveyor as required.

**4.2. Testing**

- 4.2.1. The new HVAC Units must be tested and demonstrated fully functional in accordance with the manufacturer’s instructions. Testing must be witnessed by the Technical Authority and the ABS Class Surveyor as required.

**4.3. Certification**

- 4.3.1. The Contractor must ensure the new HVAC Units meet the requirements of Class and Transport Canada.

**5. PART 5 - DELIVERABLES**

**5.1. Drawings/Reports**

- 5.1.1. The Contractor must produce two (2) electronic PDF copies of a final report for the TA upon completion of the above noted scope of work. The final report must contain

the results of all inspections, testing, manufacturer information, part numbers and details of work completed..

- 5.1.2. The Contractor must include all associated documentation related to this specification as described H-1 General Notes - Section 5 - Documentation.
- 5.1.3. See H-1 General Notes Section 6 Drawings
- 5.2. Spares**
- 5.2.1. The Contractor must supply Manufacturers recommended spares for a one (1) year period with a spare parts list.
- 5.3. Training**
- 5.3.1. The Contractor must provide familiarization training to the Technical Authority.
- 5.4. Manuals**
- 5.4.1. Contractor must include all associated manuals related to this specification as described in H-1 General Notes - Section 7 - Manuals.



	MLB	
Spec Item #: M-61	SPECIFICATION	
<b>REPLACE HVAC COOLING PUMPS</b>		

## 1. PART 1 - SCOPE

- 1.1. The intent of this specification must be for the contractor to replace the HVAC Cooling Pumps with new contractor supplied cooling pumps.
- 1.2. This work must be carried out in conjunction with the following specification items:  
M-60 Replace HVAC Units  
H-23 Replace Seawater Piping

## 2. PART 2 - REFERENCES

### 2.1. Guidance Drawings/Nameplate Data

- 2.1.1. Drawing Number 47B MLB 505-022 – Piping Arrangements in Hull (SW Cooling)
- 2.1.2. Drawing Number 47B MLB 512-001 – HVAC Diagrammatic
- 2.1.3. Drawing Number 47B MLB 512-010 – HVAC Details and Arrangement
- 2.1.4. Drawing Number 47B MLB 505-030 – Piping Arrangement in Deckhouse
- 2.1.5. Drawing Number 47B MLB 110-640 – Aux Machinery Space Arrangement
- 2.1.6. Drawing Number 47B MLB 300-020 – Electrical One Line Diagram

### 2.2. Standards

- 2.2.1. See General Notes H-1

### 2.3. Regulations

- 2.3.1. See General Notes H-1

### 2.4. Government Furnished Material

- 2.4.1. N/A

### 2.5. Contractor Furnished Material

- 2.5.1. The Contractor must supply everything that is required to perform the specified work unless otherwise stated, such as but not limited to the following: labour, materials, parts, tools, consumables, equipment, machinery, storage, shelters, staging, rigging, scaffolding, enclosures, power and heating.
- 2.5.2. Two (2) Flagship Marine MS1200, 1200 GPH pumps
- 2.5.3. Refer to Appendix A for List of Original Suppliers or Appendix B for List of Alternate/Additional Suppliers.
- 2.5.4. All supplied and installed equipment must be certified by Transport Canada and ABS.

## 3. PART 3 – TECHNICAL DESCRIPTION

**3.1. General**

- 3.1.1. The existing HVAC Cooling Pumps located in the auxiliary machinery space must be disconnected and removed from the vessel. The old pumps must be treated as Class C material and disposed of.
- 3.1.2. The Contractor must quote on supplying and installing two (2) new Flagship Marine MS1200, 1200 GPH pumps, or equivalent. The new pumps must supply cooling sea water to meet the manufacturer's requirements of the newly installed HVAC units.
- 3.1.3. The Contractor must install the new HVAC Cooling Pumps in the same location as the existing HVAC Cooling Pumps using new attachment materials.
- 3.1.4. Any disturbed aluminum work must be coated as per the paint scheme in the area.

**3.2. Location**

- 3.2.1. Auxiliary Machinery Space

**3.3. Interferences**

- 3.3.1. The Contractor is responsible for the identification of interference items, their temporary removal, storing and refitting on the vessel.

**4. PART 4 – PROOF OF PERFORMANCE**

**4.1. Inspection**

- 4.1.1. A visual inspection by the Contractor and TA in attendance, of general workmanship including that of piping, hardware, materials, and coatings must be conducted.

**4.2. Testing**

- 4.2.1. The new HVAC Cooling Pumps must be tested and demonstrated fully functional in accordance with the manufacturer's instructions. Testing must be witnessed by the Technical Authority and the ABS Class Surveyor.

**4.3. Certification**

- 4.3.1. The Contractor must ensure the new HVAC Cooling Pumps meet the requirements of Class and Transport Canada.

**5. PART 5 - DELIVERABLES**

**5.1. Drawings/Reports**

- 5.1.1. The Contractor must produce two (2) electronic PDF copies of a final report for the TA upon completion of the above noted scope of work. The final report must contain the results of all inspections, testing, manufacturer information, part numbers and details of work completed..
- 5.1.2. Contractor must include all associated documentation related to this specification as described H-1 General Notes - Section 5 – Documentation.

**5.2. Spares**

5.2.1. N/A

**5.3. Training**

5.3.1. N/A

**5.4. Manuals**

5.4.1. The Contractor must include all associated manuals related to this specification as described in H-1 General Notes - Section 7 – Manuals.

	MLB	
Spec Item #: E-100	SPECIFICATION	
GENERAL ELECTRONIC AND INFORMATICS		

## 1. PART 1 - SCOPE

1.1. The intent of this specification is to detail general work to be carried out for electronic equipment, in addition to any work specified in H-1 General Notes.

1.1.1. This work must be carried out in conjunction with all E-100 series section **Error! Reference source not found.**

## 2. PART 2 – REFERENCES

### 2.1. Guidance Drawings/Nameplate Data

2.1.1. N/A

### 2.2. Standards

2.2.1. See General Notes H-1

### 2.3. Regulations

2.3.1. See General Notes H-1

### 2.4. Government Supplied Material

2.4.1. N/A

### 2.5. Contractor Supplied Material

2.5.1. The Contractor must supply everything that is required to perform the specified work unless otherwise stated, such as but not limited to the following: labour, materials, parts, tools, consumables, equipment, machinery, storage, shelters, staging, rigging, scaffolding, enclosures, power and heating.

2.5.2. Refer to Appendix A for List of Original Suppliers or Appendix B for List of Alternate/Additional Suppliers.

2.5.3. All supplied and installed equipment must be certified by Transport Canada and ABS.

### 2.6. Guidance Drawings/Nameplate Data

2.6.1. N/A

## 3. PART 3 – TECHNICAL DESCRIPTION

### 3.1. General

3.1.1. The Contractor must ensure prior to any work commencing that both the Contractor Basic Safety Familiarization and Pre Job Safety Assessment are completed and signed off and follow all safety requirements in ME Safety section.

- 3.1.2. All material that is Contractor supply must be approved for the intended use and be of industrial marine quality.
- 3.1.3. The Contractor must ensure all Purchase Orders are approved by the Technical Authority prior to being issued to the supplier.
  - 3.1.3.1. In the event that a particular part number is no longer available, the Contractor must propose an equivalent part for approval by the Technical Authority.
- 3.1.4. Where applicable, workmanship for all electronic equipment installed must conform to:
  - 3.1.4.1. All Regulations under Canada Shipping Act;
  - 3.1.4.2. TC MSB TP127E;
  - 3.1.4.3. IEEE STD-45;
  - 3.1.4.4. CCG Specification for the Installation of Shipboard Electronic Equipment 70-000-000-EU-JA-001 ; and,
  - 3.1.4.5. CSA Standards.

### **3.2. Equipment and Cabling Removal**

- 3.2.1. The Contractor must protect all removed equipment for reuse by the CCG.
- 3.2.2. The Contractor must protect any removed cabling with factory molded connectors. For example, factory molded connectors may be fitted on power cables designed to maintain correct voltage polarity or on data cables designed to maintain ingress protection ratings of a piece of equipment.
- 3.2.3. All protected equipment and related cabling must be treated as CAT A material, and shipped to a location decided upon by the TA. Shipping costs will be via PSPC 1379 action.
- 3.2.4. Cabling that is typically supplied in bulk quantities with field-terminated connectors or connected to terminal strips must be disposed of by the Contractor. For example, RF cabling for antennas or power cabling with bare conductors on each end, when disconnected.
- 3.2.5. The Contractor must dispose of any antennas removed from the vessel unless otherwise stated in an individual section.
- 3.2.6. The contractor is responsible for unpacking/repacking all cable transits/glands. Repacking shall be made using an ABS type approved Roxtec type of cable transits.

- 3.2.7. The contractor must replace any cable transits/glands that are not ABS product type approved with Technical Authority and ABS product type approved Roxtec deck and bulkhead penetration system. Replacement if required will be via PSPC 1379 action.

### **3.3. New Cabling and Connectors**

- 3.3.1. The Contractor must use manufacturer-supplied cabling included with equipment unless otherwise stated in an individual section.
- 3.3.2. Where cabling is not included with equipment, the Contractor must supply cabling listed below, or an equivalent approved by the Technical Authority:
- 3.3.2.1. Radio Frequency (RF) e.g Antenna cabling – Time Microwave LMR 400-UF-FR
  - 3.3.2.2. CAT6/Ethernet - Belden MarineTuff 1319SB
  - 3.3.2.3. Control and Instrumentation (e.g NMEA 0183) – Belden MarineTuff 9451SB (one pair), 8723SB (two pair), 8777SB (three pair)
  - 3.3.2.4. Audio and Speaker (e.g Loudhailer) - Belden MarineTuff 1314SB (one pair), 1315SB (two pair)
- 3.3.3. For each cabling type, the Contractor must use cabling, connectors and connector installation tools from the same equipment manufacturer, in order to provide a complete, functional cabling system.
- 3.3.4. Wherever possible, the Contractor must maintain the use of Deutsch connectors as shown in the guidance drawings. Deutsch connectors must be installed inline where equipment is hardwired to the power source with no easily accessible disconnect plug or wiring terminal block to assist with equipment maintenance and replacement.
- 3.3.5. The Contractor must ensure cabling meets the following general installation requirements:
- 3.3.5.1. Be kept to a minimum length, within manufacturer specifications;
  - 3.3.5.2. Located to provide protection from mechanical abuse and heat damage;
  - 3.3.5.3. Located to avoid physical or electrical interference with equipment, cables, or other radio frequency transmission lines;
  - 3.3.5.4. Electrically balanced wherever necessary;
  - 3.3.5.5. The entrance of moisture and dirt must be prevented. Non-solid dielectric lines must be installed so there are no pockets in which moisture can collect;
  - 3.3.5.6. Installed so that the characteristic impedance of each line is not materially changed;

- 3.3.5.7. Installed so that they must not be disturbed by removal of deck plates, gratings, or machinery; and,
- 3.3.5.8. Installed so as not to impair the airtight or watertight integrity of decks or bulkheads.
- 3.3.5.9. When installing cable, force must not be applied which changes the dimension of, or otherwise damages, the mechanical and electrical properties and characteristics of the cable. Cables must not be installed in areas where the ambient temperature, plus the centre conductor temperature rise, exceeds the maximum temperature rating.
- 3.3.5.10. Terminal boxes, branch boxes, or other forms of standard electric wiring equipment must not be used to terminate or connect coaxial cable. Coaxial cable must not be spliced, with the exception of in-line connectors forming part of the equipment cabling supplied by the manufacturer.
- 3.3.5.11. Cables forming parts of different electronic circuits must be routed in separate wireways wherever practicable. Cables must be routed on the inboard side of beams or other supporting structures to provide additional protection. Cables must be located so that the maximum number of circuits must be maintained in service in case of casualty to a single area.
- 3.3.5.12. The inside bend radius of coaxial cable must be more than 10 times the cable diameter, except when the cable is subjected to repeated flexure, in which each case the inside bend radius must be more than 20 times the cable diameter.
- 3.3.5.13. All installed cables must be checked for continuity of conductors, insulation between conductors, and insulation between conductors and ground, prior to any equipment is connected.
- 3.3.5.14. Cables and connectors installed by the contractor that are found defective (fails a continuity test) or damaged must be replaced at the contractor's expense (material and labour).
- 3.3.5.15. All field terminated Ethernet cables must be tested and certified to CAT6 or otherwise replaced or reterminated at the contractors expense (material and labour) until it passes testing.
- 3.3.5.16. Cable Identification must be in accordance with the following table from CCG Specification for the Installation of Shipboard Electronic Equipment 70-000-000-EU-JA-001:

**CABLE DESIGNATION**

<b><u>SYSTEM</u></b>	<b><u>DESIGNATION</u></b>
Call bells (radio 500 kHz)	AL
Electric clock	CE
Docking announcing (talk back)	DA
Direction finder MF-HF	DF-HF
Direction finder VHF	DF-VHF
Echo depth sounder	ES
Facsimile	FC
General alarm	G
Anemometer (wind speed and direction indicator)	HD
Automatic telephone	J
Telephone sound powered ship control	1JV
Telephone sound powered engineers	2JV
Telephone sound powered miscellaneous	3JV
Gyrocompas	LC
Gyropilot (auto pilot)	LP
Emergency announcing (public address)	MC
Rudder angle indicator	N
Radio : VHF - AM	R-A
Citizens band	R-C
VHF-FM Marine	R-F
Radio : HF	R-H
Loran	R-L
Radio : MF	R-M
PINS	R-P
Satellite communicator	R-SC
Satellite navigator	R-SN
Television distribution	R-TV
Cellular telephone	R-U
Radio broadcast antenna distribution	RB
Radio broadcast and receiver entertainment	RE
Radar navigation	R-ER
Underwater log	Y

3.3.5.17. All installed cables must be tagged with cable designations at all points of connection and at each side of any barrier. The same cable designations must be used to identify cables in the “As Fitted” drawings.

3.3.5.18. The cable tags must be of the embossed metallic type and attached to cables with approved metal clips, except in equipment racks where durable,



permanent printed plastic tags must be used. Individual conductors must be either colour coded, or identified using synthetic resin tubing and permanently printed legend.

- 3.3.5.19. Self-adhesive plastic wrap-around/heat shrink sleeves may be used in certain areas, at the discretion of the Technical Authority.

### **3.4. Electromagnetic Interference Reduction**

- 3.4.1. Electromagnetic Interference (EMI) is impairment of the reception of a desired electromagnetic signal caused by unwanted electrostatic or electromagnetic disturbances. The Contractor is responsible for the identification of sources of EMI and for their subsequent suppression to ensure all equipment functions as required.
- 3.4.2. Interference conditions which are due to inherent deficiency in Contractor Supplied Material must be brought to the attention of the Technical Authority promptly after discovery.
- 3.4.3. Safety rails, lifelines, and lanyards must not generate EMI.
- 3.4.4. Electromagnetic and electrostatic disturbances that cause malfunctioning or undesirable response in electrical or electronic equipment must be eliminated.
- 3.4.5. Cables must be routed to protect against electromagnetic interference. Cables that must be routed to topside or exposed locations must be shielded, either by use of shielded cables or by use of single or multi-cable conduit, or both.
- 3.4.6. Equipment and electronic systems which can interact due to electromagnetic or electrostatic fields must be separated or shielded.

## **4. PART 3 – PROOF OF PERFORMANCE**

### **4.1. Inspection**

- 4.1.1. In addition to any inspections listed in an individual section, all work carried out must be verified correct and approved by the Technical Authority according to the following checks at a minimum at the following intervals :

#### **4.1.1.1. Equipment removal**

- 4.1.1.1.1. Verify that all of the old equipment has been removed in accordance with the specification.

#### **4.1.1.2. Cabling installation**

- 4.1.1.2.1. Verify that cabling has been installed in accordance with the specification.

#### **4.1.1.3. Equipment installation**

- 4.1.1.3.1. Verify that the correct equipment has been provided and installed

4.1.1.3.2. Verify the unit interconnections and power wiring prior to turning on;

4.1.1.3.3. Verify all units are properly grounded.

**4.1.1.4. Drawings/Reports**

4.1.1.4.1. Verify drawings/reports have been completed in accordance with the specification and are accurate.

**4.2. Testing**

4.2.1. The Contractor must demonstrate correct function of each piece of equipment in the form of a site acceptance test in accordance with the document “Acceptance Procedure E-100 series.xlsx”. Where possible the site acceptance test(s) must be coordinated with other trades (e.g. Marine Engineering).

4.2.2. The contractor shall contract a specialized individual to proceed with the calibration of the magnetic compass during dock trials and sea trials.

**4.3. Certification**

4.3.1. N/A

**5. PART 4 - DELIVERABLES**

**4.1. Drawings/Reports**

4.1.1. The Contractor must supply the Technical Authority with one (1) hard copy and one (1) electronic copy of all work carried out in the specification including make/model and serial number of all equipment installed.

4.1.2. The Contractor must supply drawings in AutoCad format of all work completed.

4.1.3. The Contractor must detail work completed in AutoCad drawings with same or better level of information and detail as provided in the as-built guidance drawings.

4.1.4. The Contractor must prepare drawings, based upon the Manufacturers' installation data, showing the electrical details of the intended installation of each electronic system (i.e. cable details such as identifier number and type, connector detail, power supply detail, etc.). Point to point connection detail may be supplied separately, but the drawing must reference the source.

4.1.5. Installation drawings must be submitted to the Technical Authority for examination and approval prior to project being deemed complete.

4.1.6. The Contractor must include all associated documentation related to this specification as described H-1 General Notes - Section 5 – Documentation

**4.2. Spares**

4.2.1. N/A

**4.3. Training**

4.3.1. N/A

**4.4. Manuals**

4.4.1. The Contractor must include all associated manuals related to this specification as described in H-1 General Notes - Section 7 – Manuals

	MLB	
Spec Item #: E-101	SPECIFICATION	
<b>REPLACE BATTERY CHARGERS</b>		

## **1. PART 1 - SCOPE**

- 1.1.** The intent of this specification must be for the contractor to replace the existing battery charger with contractor supplied battery charger.

## **2. PART 2 - REFERENCE**

### **2.1. Guidance Drawings/Nameplate Data**

- 2.1.1. Drawing Number 47B MLB 300-020 – Electrical One Line Diagram  
 2.1.2. Drawing Number 47B MLB 110-640 – Aux Machinery Space Arrangement

### **2.2. Standards**

- 2.2.1. See General Notes H-1

### **2.3. Regulations**

- 2.3.1. See General Notes H-1

### **2.4. Government Supplied Material**

- 2.4.1. N/A

### **2.5. Contractor Supplied Material**

- 2.5.1. The Contractor must supply everything that is required to perform the specified work unless otherwise stated, such as but not limited to the following: labour, materials, parts, tools, consumables, equipment, machinery, storage, shelters, staging, rigging, scaffolding, enclosures, power and heating.
- 2.5.2. LaMarche Constavolt Model A41-60-24V-A1\_12L-10055 Battery Charger
- 2.5.3. Refer to Appendix A for List of Original Suppliers or Appendix B for List of Alternate/Additional Suppliers.
- 2.5.4. All supplied and installed equipment must be certified by Transport Canada and/or the RO.

## **3. PART 3 – TECHNICAL DESCRIPTION**

### **3.1. General**

- 3.1.1. The existing battery charger LaMarche Constavolt Model A41-60-24V-A1\_12L-10055 located in the electrical room forward of the survivor space must be disconnected and removed from the vessel. The old battery charger must be treated as Class A material and crated must be shipped to a location determined by the Technical Authority. Shipping cost will be covered by a work arising via PSPC 1379 action.

- 3.1.2. The Contractor must quote on supplying and installing one (1) new LaMarche Constavolt Model A41-60-24V-A1\_12L-10055 battery charger, or equivalent.
- 3.1.3. The Contractor must install the new battery charger in the same location as the existing battery charger using new attachment materials.
- 3.1.4. The Contractor must connect the new battery charger to the electrical system.
- 3.1.5. Any disturbed aluminum work must be coated as per the paint scheme in the area.
- 3.1.6. All work must be carried out must be verified by the Technical Authority

### **3.2. Location**

- 3.2.1. Auxiliary Machinery space

### **3.3. Interferences**

- 3.3.1. The Contractor is responsible for the identification of interference items, their temporary removal, storing and refitting on the vessel.

## **4. PART 4 – PROOF OF PERFORMANCE**

### **4.1. Inspection**

- 4.1.1. A visual inspection by the Contractor and TA in attendance, of general workmanship including that of piping, hardware, materials, and coatings must be conducted.

### **4.2. Testing**

- 4.2.1. The new battery chargers must be tested and demonstrated fully functional in accordance with the manufacturer's instructions. Testing must be witnessed by the Technical Authority and the ABS Class Surveyor.

### **4.3. Certification**

- 4.3.1. The Contractor must ensure the new battery chargers meet the requirements of Class and Transport Canada.

## **5. PART 5 - DELIVERABLES**

### **5.1. Drawings/Reports**

- 5.1.1. The Contractor must produce two (2) electronic PDF copies of a final report for the TA upon completion of the above noted scope of work. The final report must contain the results of all inspections, testing, manufacturer information, part numbers and details of work completed..
- 5.1.2. The Contractor must include all associated documentation related to this specification as described H-1 General Notes - Section 5 - Documentation.

### **5.2. Spares**

- 5.2.1. N/A

### **5.3. Training**

5.3.1. The Contractor must provide familiarization training to the Technical Authority.

**5.4. Manuals**

5.4.1. The Contractor must provide two (2) copies of manuals describing the battery chargers, any maintenance requirements and operating instructions as described in H-1 General Notes - Section 7 - Manuals.

	MLB	
Spec Item #: E-102	SPECIFICATION	
REPLACE BATTERIES		

## 1. PART 1 - SCOPE

- 1.1. The intent of this specification must be for the contractor to replace the existing batteries with contractor supplied batteries. This work must be done in concurrence with the hull plate renewal spec item H-7.

## 2. PART 2 - REFERENCES

### 2.1. Guidance Drawings/Nameplate Data

- 2.1.1. Drawing Number 47B MLB 110-640 – Aux Machinery Space Arrangement  
 2.1.2. Drawing Number 47B MLB 300-020 – Electrical One line Diagram

### 2.2. Standards

- 2.2.1. See General Notes H-1

### 2.3. Regulations

- 2.3.1. See General Notes H-1

### 2.4. Government Supplied Material

- 2.4.1. N/A

### 2.5. Contractor Supplied Material

- 2.5.1. The Contractor must supply everything that is required to perform the specified work unless otherwise stated, such as but not limited to the following: labour, materials, parts, tools, consumables, equipment, machinery, storage, shelters, staging, rigging, scaffolding, enclosures, power and heating.
- 2.5.2. Four (4) Maintenance Free Batteries, Caterpillar PN 8D 153-5720
- 2.5.3. Refer to Appendix A for List of Original Suppliers or Appendix B for List of Alternate/Additional Suppliers.
- 2.5.4. All supplied and installed equipment must be certified by Transport Canada and/or the RO.

## 3. PART 3 – TECHNICAL DESCRIPTION

### 3.1. General

- 3.1.1. The existing maintenance free batteries located in the electrical room forward of the survivor space must be disconnected and removed from the vessel. The old batteries must be treated as Class C material disposed of by the Contractor. The Contractor must supply certificate to demonstrate the batteries were disposed with in accordance

with environmental regulations in effect in the geographical area of the Contractor's facilities.

- 3.1.2. The Contractor must quote on supplying and installing four (4) new Maintenance Free Batteries, Caterpillar PN 8D 153-5720, or equivalent.
- 3.1.3. The Contractor must install the new batteries in the same location as the existing batteries using new cables and attachment materials.
- 3.1.4. The area beneath the batteries must be cleaned and recoated in accordance with the coating specification for that area.

### **3.2. Location**

- 3.2.1. Auxiliary Machinery Space

### **3.3. Interferences**

- 3.3.1. The Contractor is responsible for the identification of interference items, their temporary removal, storing and refitting on the vessel.

## **4. PART 4 PROOF OF PERFORMANCE**

### **4.1. Inspection**

- 4.1.1. A visual inspection by the Contractor and TA in attendance, of general workmanship including that of piping, hardware, materials, and coatings must be conducted.

### **4.2. Testing**

- 4.2.1. The new Batteries must be tested and demonstrated fully functional in accordance with the manufacturer's instructions. Testing must be witnessed by the Technical Authority and the ABS Class Surveyor.

### **4.3 Certification**

- 4.2.2. The Contractor must ensure the new batteries meet the requirements of Class and Transport Canada.

## **5. PART 5 - DELIVERABLE**

### **5.1. Drawings/Reports**

- 5.1.1. The Contractor must produce two (2) electronic PDF copies of a final report for the TA upon completion of the above noted scope of work. The final report must contain the results of all inspections, testing, manufacturer information, part numbers and details of work completed..
- 5.1.2. The Contractor must include all associated documentation related to this specification as described H-1 General Notes - Section 5 - Documentation.

### **5.2. Spares**



5.2.1. N/A

**5.3. Training**

5.3.1. N/A

**5.4. Manuals**

5.4.1. The Contractor must provide two (2) copies of manuals in bi-lingual format English/French describing the batteries, any maintenance requirements and operating instructions as described in H-1 General Notes - Section 7 - Manuals

	MLB	
Spec Item #: E-103	SPECIFICATION	
REPLACE NAVIGATION LIGHTS		

### 1. PART 1: SCOPE:

- 1.1. The intent of this spec is to replace the each navigation light with new lights and fixtures of the same design as what is currently fitted on the vessel.
- 1.2. This work must be carried out in conjunction with work in the wheel house, on the mast and prior to top side painting.

### 2. PART 2: REFERENCES:

#### 2.1. Guidance Drawings/Nameplate Data

- 2.1.1. Drawing Number 47B MLB 331-010 – Lights and Switches Installation
- 2.1.2. Drawing Number 47B MLB 330-010 - Schematic Wiring Diagrams and Connection Details
- 2.1.3. Drawing Number 47B MLB 171-010 – Mast
- 2.1.4. Drawing Number 47B MLB 438-010 – Console Arrangement
- 2.1.5. Drawing Number 47B MLB 150-030 – Open Bridge Deck
- 2.1.6. Drawing Number 47B MLB 150-080 – Enclosed Bridge Top

#### 2.2. Standards

- 2.2.1. See General Notes H-1

#### 2.3. Regulations

- 2.3.1. See General Notes H-1

#### 2.4. Government Supplied Material

- 2.4.1. N/A

#### 2.5. Contractor Supplied Material

- 2.5.1. The Contractor must supply everything that is required to perform the specified work unless otherwise stated, such as but not limited to the following: labour, materials, parts, tools, consumables, equipment, machinery, storage, shelters, staging, rigging, scaffolding, enclosures, power and heating.
- 2.5.2. Refer to Appendix A for List of Original Suppliers or Appendix B for List of Alternate/Additional Suppliers.
- 2.5.3. All supplied and installed equipment must be certified by RO.

### 3. PART 3: TECHNICAL DESCRIPTION:

#### 3.1. General

- 3.1.1. The Contractor to ensure prior to any work commencing that both the Contractor Basic Safety Familiarization and Pre Job Safety Assessment are completed and signed off
- 3.1.2. All required material must be Contractor supplied, approved for the intended use and be of industrial marine quality.
- 3.1.3. The Contractor must ensure all Purchase Orders are reviewed by the Technical Authority prior must being issued to the supplier.
- 3.1.4. The Contractor must remove the existing navigation lights and remove ashore for disposal.
- 3.1.5. Wire securing brackets must be cleaned and repainted prior to reinstallation of wiring
- 3.1.6. Areas exposed by the removal of light fixture must be cleaned and repainted using the painting scheme and materials in the affected areas.
- 3.1.7. The Contractor must install the new navigation lighting in the same location as the removed equipment.
- 3.1.8. The Contractor must demonstrate the operability of the new equipment to the Technical Authority and ABS Class Inspector.
- 3.1.9. The Contractor must ensure the new navigation lighting functions, as designed, with the navigation alarm panel.

### **3.2. Location**

- 3.2.1. Vessel topside and mast.

### **3.3. Interferences**

- 3.3.1. The Contractor is responsible for the identification of all interference items, their temporary removal, storage, and refitting to the vessel.

## **4. PART 4: PROOF OF PERFORMANCE:**

### **4.1. Inspection**

- 4.1.1. A visual inspection by the Contractor and TA in attendance, of general workmanship including that of piping, hardware, materials, and coatings must be conducted.

### **4.2. Testing**

- 4.2.1. The Contractor must demonstrate the operation of the system to the Technical Authority and Class Inspector. Any defects found must be corrected and the system again demonstrated to Technical Authority and Class Inspector.

### **4.3. Certification**

- 4.3.1. Copy of the equipment certification must be supplied to the Technical Authority.

## **5. PART 5: DELIVERABLES:**

### **5.1. Drawings/Reports**

5.1.1. The Contractor must produce two (2) electronic PDF copies of a final report for the TA upon completion of the above noted scope of work. The final report must contain the results of all inspections, testing, manufacturer information, part numbers and details of work completed..

5.1.2. The Contractor must include all associated documentation related to this specification as described H-1 General Notes - Section 5 - Documentation.

5.1.3. See H-1 General Notes Section 6 Drawings

**5.2. Spares**

5.2.1. N/A

**5.3. Training**

5.3.1. N/A

**5.4. Manuals**

5.4.1. The Contractor must include all associated manuals related to this specification as described in H-1 General Notes - Section 7 - Manuals.

	MLB	
Spec Item #: E-104	SPECIFICATION	
REPLACE ELECTRICAL BREAKERS		

### 1. PART 1 - SCOPE

- 1.1. The intent of this spec is to replace all of the existing electrical breakers on the vessel with new breakers of the same size and manufacture.

### 2. PART 2 – REFERENCES

#### 2.1. Guidance Drawings/Nameplate Data

- 2.1.1. Drawing Number 47B MLB 110-640 – Auxiliary Machinery Space Arrangement  
 2.1.2. Drawing Number 47B MLB 300-020 - Electrical One Line Diagram

#### 2.2. Standards

- 2.2.1. See General Notes H-1

#### 2.3. Regulations

- 2.3.1. See General Notes H-1

#### 2.4. Government Supplied Material

- 2.4.1. N/A

#### 2.5. Contractor Supplied Material

- 2.5.1. The Contractor must supply everything that is required to perform the specified work unless otherwise stated, such as but not limited to the following: labour, materials, parts, tools, consumables, equipment, machinery, storage, shelters, staging, rigging, scaffolding, enclosures, power and heating.
- 2.5.2. Refer to Appendix A for List of Original Suppliers or Appendix B for List of Alternate/Additional Suppliers.
- 2.5.3. All supplied and installed equipment must be certified by Transport Canada and ABS.

### 3. PART 3 – TECHNICAL DESCRIPTION

#### 3.1. General

- 3.1.1. The Contractor must ensure prior to any work commencing that both the Contractor Basic Safety Familiarization and Pre Job Safety Assessment are completed and signed off
- 3.1.2. The Contractor must remove all the existing breakers using care to not damage the breakers or panels.

3.1.3. The Contractor must present the purchase order to replace all of the breakers to the Technical Authority for review prior to ordering.

3.1.4. The Contractor must install all of the the new breakers in existing panels.

**3.2. Location**

3.2.1. Throughout ship

**3.3. Interferences**

3.3.1. The Contractor is responsible for the identification of all interference items, their temporary removal, secure storage, and refitting to the vessel.

**4. PART 4 – PROOF OF PERFORMANCE**

**4.1. Inspection**

4.1.1. A visual inspection by the Contractor and TA in attendance, of general workmanship including that of piping, hardware, materials, and coatings must be conducted.

**4.2. Testing**

4.2.1. The Contractor must demonstrate all functions of the breakers to the Technical Authority and the attending ABS Class inspector. The Contractor must correct any deficiencies found and retest the system.

4.2.2. The Contractor must demonstrate the electrical system is free of electrical grounds.

**4.3. Certification**

4.3.1. The supplied breakers must be approved for use on the vessel of this size by Class and Transport Canada. Breakers must not be installed until certification is reviewed and approved by the Technical Authority.

4.3.2. Refer to Regulations in H-1 General Notes

**5. PART 5 – DELIVERABLES**

**5.1. Drawings/Reports**

5.1.1. The Contractor must produce two (2) electronic PDF copies of a final report for the TA upon completion of the above noted scope of work. The final report must contain the results of all inspections, testing, manufacturer information, part numbers and details of work completed..

5.1.2. The Contractor must include all associated documentation related to this specification as described H-1 General Notes - Section 5 - Documentation.

**5.2. Spares**

5.2.1. N/A

**5.3. Training**

5.3.1. N/A

**5.4. Manuals**

5.4.1. The Contractor must include all associated manuals related to this specification as described in H-1 General Notes - Section 7 - Manuals.

	MLB	
Spec Item #: E-105	SPECIFICATION	
REPLACE SHORE POWER BREAKER & RECEPTACLE		

## 1. PART 1 - SCOPE

- 1.1. The intent of this spec is to replace the existing shore power plug, receptacle, wire and breaker with new of the same quality, rating and manufacturer.

## 2. PART 2 – REFERENCES

### 2.1. Guidance Drawings/Nameplate Data

- 2.1.1. Drawing Number 47B MLB 100-640 – Auxiliary Machinery Space Arrangement  
 2.1.2. Drawing Number 47B MLB 300-020 – Electrical One Line Diagram

### 2.2. Standards

- 2.2.1. See General Notes H-1

### 2.3. Regulations

- 2.3.1. See General Notes H-1

### 2.4. Government Supplied Material

- 2.4.1. N/A

### 2.5. Contractor Supplied Material

- 2.5.1. The Contractor must supply everything that is required to perform the specified work unless otherwise stated, such as but not limited to the following: labour, materials, parts, tools, consumables, equipment, machinery, storage, shelters, staging, rigging, scaffolding, enclosures, power and heating.
- 2.5.2. Refer to Appendix A for List of Original Suppliers or Appendix B for List of Alternate/Additional Suppliers

## 3. PART 3 – TECHNICAL DESCRIPTION

### 3.1. General

- 3.1.1. The Contractor to ensure prior to any work commencing that both the Contractor Basic Safety Familiarization and Pre Job Safety Assessment are completed and signed off.
- 3.1.2. The Contractor must remove the existing shore power receptacle using care to not damage the aluminum deck and any equipment in the space. Cable is located in the anchor pocket port side.
- 3.1.3. The Contractor must clean and inspect the area exposed by removal of the receptacle. Prior to painting the area it must be inspected by the technical authority.



- 3.1.4. The Contractor must paint and preserve the exposed area using the same painting scheme and materials as the surrounding area.
- 3.1.5. The Contractor must install the new receptacle to existing attachments.
- 3.1.6. The Contractor must remove the existing cable running from the receptacle to the shore power breaker in the auxiliary machinery space.
- 3.1.7. The Contractor must supply and install a new cable running from the shore power breaker located in the auxiliary machinery space to the newly installed receptacle following the same route as the old cable. Supplied cable must be three wire of the same rating as cable removed.
- 3.1.8. Existing bulkhead transits must be used.
- 3.1.9. The Contractor in installing must include a one (1) meter loop in the line to allow for new terminations at a later time.
- 3.1.10. The Contractor must verify the installation of the line is free of grounds using a megger.

**3.2. Location**

- 3.2.1. Bow area, Auxiliary Machinery Space

**3.3. Interferences**

- 3.3.1. The Contractor is responsible for the identification of all interference items, their temporary removal, secure storage, and refitting to the vessel.

**4. PART 4 – PROOF OF PERFORMANCE**

**4.1. Inspection**

- 4.1.1. A visual inspection by the Contractor and TA in attendance, of general workmanship including that of piping, hardware, materials, and coatings must be conducted.
- 4.1.2. All work must be carried out must be verified correct and approved by the Technical Authority and the attending RO Class inspector.

**4.2. Testing**

- 4.2.1. The Contractor must demonstrate all functions of the receptacle and line to the Technical Authority and the attending RO Class inspector. The Contractor must correct any deficiencies found and retest the system.
- 4.2.2. Cable must be megger tested and proven free of grounds.

**4.3. Certification**

- 4.3.1. The supplied cable must be approved for use on the vessel of this size by Class and Transport Canada.

## **5. PART 5 – DELIVERABLES**

### **5.1. Drawings/Reports**

- 5.1.1. The Contractor must produce two (2) electronic PDF copies of a final report for the TA upon completion of the above noted scope of work. The final report must contain the results of all inspections, testing, manufacturer information, part numbers and details of work completed..
- 5.1.2. The Contractor must include all associated documentation related to this specification as described H-1 General Notes - Section 5 – Documentation.

### **5.2. Spares**

- 5.2.1. N/A

### **5.3. Training**

- 5.3.1. The Contractor must demonstrate the operation of the receptacle to the Technical Authority and two (2) of the vessels crew members.

### **5.4. Manuals**

- 5.4.1. N/A

	MLB	
Spec Item #: E-106	SPECIFICATION	
REFURBISH SEARCHLIGHTS		

## 1. PART 1 - SCOPE

- 1.1.** The intent of this specification must refurbish the search light and to add a remote control function. Refurbishment must include the supply and installation of new components to replace the entire system.
- 1.2.** This work must be carried out in conjunction with work on the mast, painting and other topside work.

## 2. PART 2 – REFERENCES

### 2.1. Guidance Drawings/Nameplate Data

- 2.1.1. Drawing Number 47B MLB 300-020 – Electrical One Line Diagram
- 2.1.2. Drawing Number 47B MLB 330-010 – Lighting System Diagram
- 2.1.3. Drawing Number 47B MLB 331-010 – Lights and Switches Installation

### 2.2. Standards

- 2.2.1. See H-1 General Notes.

### 2.3. Regulations

- 2.3.1. See H-1 General Notes.

### 2.4. Government Supplied Material

- 2.4.1. N/A

### 2.5. Contractor Supplied Material

- 2.5.1. The Contractor must supply everything that is required to perform the specified work unless otherwise stated, such as but not limited to the following: labour, materials, parts, tools, consumables, equipment, machinery, storage, shelters, staging, rigging, scaffolding, enclosures, power and heating.
- 2.5.2. Refer to Appendix A for List of Original Suppliers or Appendix B for List of Alternate/Additional Suppliers.
- 2.5.3. Current Carlisle and Finch Co. Searchlights supplied by Jastram Technologies Ltd
- 2.5.4. 200 Watt Xenon Searchlight systems, model number CF-XY2EDE-RF-PGK1, each complete with:
- 2.5.5. One (1) CF-2PS115 Electronic Current-Regulated Power Supply with 115 volt, 50/60 Hz input,

- 2.5.6. One (1) CF-C4-2 Master Control Station which includes Beam OFF/ON Switch, Electric Beam-Size Focus Switch and Joystick which controls the speed and direction of beam,
- 2.5.7. One (1) CF-C4E2M-1 Slave Control Station, custom tall,
- 2.5.8. One (1) CF-10200 200 Watt Xenon Lamp,
- 2.5.9. One (1) CF-XP600 600Watt Inverter 24VDC.
- 2.5.10. One (1) 14164X Plug and Cable Assembly – 20’ of cable
- 2.5.11. One (1) 14165X-2 Dummy Plug Assembly,
- 2.5.12. One (1) C4E2M Weatherproof Control

### **3. PART 3 – TECHNICAL DESCRIPTION**

#### **3.1. General**

- 3.1.1. The Contractor must ensure prior to any work commencing, that both the Contractor Basic Safety Familiarization and Pre Job Safety Assessment are completed and signed off
- 3.1.2. The Contractor must dismantle the existing system except for wiring and mounts and remove ashore for crating and shipping. Cost of shipping must be covered via PSPC 1379 action.
- 3.1.3. The Contractor must verify the wiring and determine it is free of defects.
- 3.1.4. The Contractor must megger test existing wire and ensure resistance to ground is at infinity. Technical authority to witness readings. Replacement if required will be via PSPC 1379 action.
- 3.1.5. The Contractor must install contractor supplied replacement components in the same location as those removed. Contractor must ensure connectors are watertight including installation of a protective sealing gel.
- 3.1.6. The Contractor must install on the open bridge a remote control for the searchlight. The remote must be wired into the control location to the starboard side of the helm position on the open bridge and come complete with a ten (10) Meter cord.
- 3.1.7. The Contractor must demonstrate the system alongside as part of a dock trial. Demonstration must be witnessed by the Technical Authority.

#### **3.2. Location**

- 3.2.1. Wheelhouse and open bridge.

#### **3.3. Interferences**

- 3.3.1. The Contractor is responsible for the identification of all interference items, their temporary removal, storage, and refitting to the vessel.

#### **4. PART 4 – PROOF OF PERFORMANCE**

##### **4.1. Inspection**

4.1.1. A visual inspection by the Contractor and TA in attendance, of general workmanship including that of piping, hardware, materials, and coatings must be conducted.

##### **4.2. Testing**

4.2.1. The Contractor must operate the system in the presence of the Technical Authority and demonstrate all control functions including remote control.

##### **4.3. Certification**

4.3.1. N/A

#### **5. PART 5 – DELIVERABLES**

##### **5.1. Drawings/Reports**

5.1.1. The Contractor must produce two (2) electronic PDF copies of a final report for the TA upon completion of the above noted scope of work. The final report must contain the results of all inspections, testing, manufacturer information, part numbers and details of work completed..

5.1.2. The Contractor must include all associated documentation related to this specification as described H-1 General Notes - Section 5 - Documentation

##### **5.2. Spares**

5.2.1. N/A

##### **5.3. Training**

5.3.1. N/A

##### **5.4. Manuals**

5.4.1. The Contractor must supply manuals describing the system and include a parts list with part numbers. Manual must be in bi-lingual format English/French as described in H-1 General Notes - Section 7 - Manuals.

	MLB	
Spec Item #: E-107	SPECIFICATION	
MEGGER TEST WIRING		

### 1. PART 1: SCOPE:

- 1.1. The intent of this specification must be for the Contractor to test the insulation resistance of all electrical distribution systems onboard, to satisfy the annual requirements of TCMS. Tracing and repair of any/all ground faults detected or replacement of wiring must be via PSPC 1379 action.

### 2. PART 2: REFERENCES:

#### 2.1. Guidance Drawings/Nameplate Data

- 2.1.1. Drawing Number 47B MLB 300-020 – Electrical One Line Diagram

#### 2.2. Standards

- 2.3. See H-1 General Notes.

#### 2.4. Regulations

- 2.4.1. Readings must be recorded and deemed acceptable IAW TP 127 Electrical Code for ships.
- 2.4.2. See H-1 General Notes.

#### 2.5. Government Supplied Material

- 2.5.1. N/A

#### 2.6. Contractor Supplied Material

- 2.6.1. The Contractor must supply everything that is required to perform the specified work unless otherwise stated, such as but not limited to the following: labour, materials, parts, tools, consumables, equipment, machinery, storage, shelters, staging, rigging, scaffolding, enclosures, power and heating.
- 2.6.2. Refer to Appendix A for List of Original Suppliers or Appendix B for List of Alternate/Additional Suppliers

### 3. PART 3: TECHNICAL DESCRIPTION:

#### 3.1. General

- 3.1.1. The Contractor must ensure prior to any work commencing, that both the Contractor Basic Safety Familiarization and Pre Job Safety Assessment are completed and signed off.
- 3.1.2. The Contractor must megger test all essential and non-essential circuits and transformers onboard the vessel.

- 3.1.3. The Contractor must inform the Technical Authority before any megger testing is to take place as not to greatly disrupt normal shipboard activities.
- 3.1.4. The Contractor is responsible for the isolation of any and all electronic equipment throughout the vessel during megger testing.
- 3.1.5. The Contractor must notify the Technical Authority of any ground found with a recommendation to repair or replace wiring. Repair or replacement will be considered work arising and addressed via PSC 1379 action.
- 3.1.6. The Contractor must restore connections to all circuits tested and must ensure that each of the circuits is operating correctly.

**3.2. Location**

- 3.2.1. Various locations throughout the vessel

**3.3. Interferences**

- 3.3.1. The Contractor is responsible for the identification of interference items, their temporary removal, storing and refitting on the vessel.

**4. PART 4: PROOF OF PERFORMANCE:**

**4.1. Inspection**

- 4.1.1. All work must be verified and accepted by the Technical Authority and the ABS Class inspector.

**4.2. Testing**

- 4.2.1. Any repairs to grounded circuits must be tested, by the contractor, before being considered complete.

**4.3. Certification**

- 4.3.1. The Contractor must provide current calibration certificates for all meters used during testing.
- 4.3.2. This inspection must be carried out in order to obtain TCMS/ABS credit.

**5. PART 5: DELIVERABLES:**

**5.1. Drawings/Reports**

- 5.1.1. The Contractor must produce two (2) electronic PDF copies of a final report for the TA upon completion of the above noted scope of work. The final report must contain the results of all inspections, testing, manufacturer information, part numbers and details of work completed..
- 5.1.2. The Contractor must include all associated documentation related to this specification as described H-1 General Notes - Section 5 - Documentation.

**5.2. Spares**

5.2.1. N/A

**5.3. Training**

5.3.1. N/A

**5.4. Manuals**

5.4.1. N/A



	MLB	
Spec Item #: E-108	SPECIFICATION	
REPLACE FUEL GAUGES & SENDERS		

## 1. PART 1 - SCOPE

- 1.1. The intent of this spec is to replace the existing fuel level sensor in the fuel tank and display in the wheelhouse and replace with a new contractor supplied system of the same design materials and quality.
- 1.2. Must be done in conjunction with H-29 Fuel Tank.

## 2. PART 2 – REFERENCES

### 2.1. Guidance Drawings/Nameplate Data

- 2.1.1. Drawing Number 47B MLB 505-024 – Piping Arrangement in Hull (Fuel System)
- 2.1.2. Drawing Number 47B MLB 436-011 – Control and Alarm Systems (Fuel Level Indicating System)
- 2.1.3. Drawing Number 47B MLB 300-020 – Electrical One Line Diagram
- 2.1.4. Drawing Number 47B MLB 330-010 – Schematic Wiring Diagrams
- 2.1.5. Drawing Number 47B MLB 438-010 – Console Arrangement
- 2.1.6. Drawing Number 47B MLB 150-070 – Console Structure

### 2.2. Standards

- 2.2.1. See General Notes H-1

### 2.3. Regulations

- 2.3.1. See General Notes H-1

### 2.4. Government Supplied Material

- 2.4.1. N/A

### 2.5. Contractor Supplied Material

- 2.5.1. The Contractor must supply everything that is required to perform the specified work unless otherwise stated, such as but not limited to the following: labour, materials, parts, tools, consumables, equipment, machinery, storage, shelters, staging, rigging, scaffolding, enclosures, power and heating.
- 2.5.2. Refer to Appendix A for List of Original Suppliers or Appendix B for List of Alternate/Additional Suppliers.
- 2.5.3. Forster Instruments Inc. VDO Fuel Sending Units, 24 VDC, p/n 224-260 (23.6” Long)
- 2.5.4. Forster Instruments Inc. VDO Fuel Level Gauge, 24 VDC, p/n A2C53412990-S

### **3. PART 3 – TECHNICAL DESCRIPTION**

#### **3.1. General**

- 3.1.1. The Contractor must ensure prior to any work commencing, that both the Contractor Basic Safety Familiarization and Pre Job Safety Assessment are completed and signed off.
- 3.1.2. The Contractor must remove fuel and clean the fuel tank.
- 3.1.3. The Contractor must remove the existing sensor located in the fuel tank below the survivor space. The Contractor must ensure the tank has been cleaned, gas freed and a certificate issued declaring the space safe to enter and work in.
- 3.1.4. The Contractor must remove the display located in the enclosed wheelhouse.
- 3.1.5. The Contractor must disconnect and remove the wiring connecting the two units.
- 3.1.6. The Contractor must supply and install replacement units of the same size, quality. Unit must be certified for commercial use.
- 3.1.7. The Contractor must connect the sensor and the display using new wire and connection and following the existing routing.
- 3.1.8. The Contractor must demonstrate the operation of the display and sensor during tank fill up at the end of the project.

#### **3.2. Location**

- 3.2.1. Below survivor space deck and enclosed wheel house.

#### **3.3. Interferences**

- 3.3.1. The Contractor is responsible for the identification of all interference items, their temporary removal, secure storage, and refitting to the vessel.

### **4. PART 4 – PROOF OF PERFORMANCE**

#### **4.1. Inspection**

- 4.1.1. A visual inspection by the Contractor and TA in attendance, of general workmanship including that of piping, hardware, materials, and coatings must be conducted.

#### **4.2. Testing**

- 4.2.1. The Contractor must demonstrate the correct operation to the Technical Authority and ABS Inspector. The Contractor must correct any deficiencies found and retest.

#### **4.3. Certification**

- 4.3.1. Refer to Regulations in H-1 General Notes

### **5. PART 5 – DELIVERABLES**

**5.1. Drawings/Reports**

- 5.1.1. The Contractor must produce two (2) electronic PDF copies of a final report for the TA upon completion of the above noted scope of work. The final report must contain the results of all inspections, testing, manufacturer information, part numbers and details of work completed..
- 5.1.2. The Contractor must include all associated documentation related to this specification as described H-1 General Notes - Section 5 - Documentation

**5.2. Spares**

- 5.2.1. N/A

**5.3. Training**

- 5.3.1. N/A

**5.4. Manuals**

- 5.4.1. The Contractor must include all associated manuals related to this specification as described in H-1 General Notes - Section 7 - Manuals.

	MLB	
Spec Item #: E-109	SPECIFICATION	
EXTERIOR WEATHER DECK LIGHTING		

## 1. PART 1 - SCOPE

- 1.1. The intent of this specification is to replace the existing exterior weather deck lights and fixtures with LED lights of an equivalent make and model of fixture that must fit in the same bulkhead openings.

## 2. PART 2 – REFERENCES

### 2.1. Guidance Drawings/Nameplate Data

- 2.1.1. Drawing Number 47B MLB 300-020 – Electrical One Line Diagram  
 2.1.2. Drawing Number 47B MLB 330-010 – Lighting System Diagram  
 2.1.3. Drawing Number 47B MLB 331-010 – Lights and Switches Installation

### 2.2. Standards

- 2.2.1. See general Notes H-1

### 2.3. Regulations

- 2.3.1. See general Notes H-1

### 2.4. Government Supplied Material

- 2.4.1. N/A

### 2.5. Contractor Supplied Material

- 2.5.1. The Contractor must supply everything that is required to perform the specified work unless otherwise stated, such as but not limited to the following: labour, materials, parts, tools, consumables, equipment, machinery, storage, shelters, staging, rigging, scaffolding, enclosures, power and heating.
- 2.5.2. Refer to Appendix A for List of Original Suppliers or Appendix B for List of Alternate/Additional Suppliers
- 2.5.3. Existing step lights are Pauluhn Model# 827A

## 3. PART 3 – TECHNICAL DESCRIPTION

### 3.1. General

- 3.1.1. The Contractor must ensure prior to any work commencing that both the Contractor Basic Safety Familiarization and Pre Job Safety Assessment are completed and signed off.

- 3.1.2. Prior to commencing the removal of old lights the Contractor must verify the function of existing light circuits. Cost of repair to any circuit will be via PSPC 1379 action.
- 3.1.3. The Contractor must dismantle existing light fixtures and remove ashore for disposal.
- 3.1.4. The bulkhead openings that house the lights must be cleaned to bare aluminium and any damage rectified. Any repairs will be treated as work arising via PSPC 1379 action.
- 3.1.5. The Contractor must supply and install replacement fixtures.
- 3.1.6. LED fixtures must be in accordance with Transportation Bulletin on LEDs which states that LEDs must be certified to IEC60533 and IEC 60945.
- 3.1.7. The Contractor must verify the function of the new LED lights.
- 3.1.8. The Contractor must demonstrate the function of the lights to the Technical Authority. Any non-functioning lights must be corrected.

### **3.2. Location**

- 3.2.1. Vessel exterior

### **3.3. Interferences**

- 3.3.1. The Contractor is responsible for the identification of all interference items, their temporary removal, storage, and refitting to the vessel.

## **4. PART 4 – PROOF OF PERFORMANCE**

### **4.1. Inspection**

- 4.1.1. A visual inspection by the Contractor and TA in attendance, of general workmanship including that of piping, hardware, materials, and coatings must be conducted.

### **4.2. Testing**

- 4.2.1. The Contractor must operate the light in the presence of the Technical Authority and demonstrate all lights and switches.

### **4.3. Certification**

- 4.3.1. N/A

## **5. PART 5 – DELIVERABLES**

### **5.1. Drawings/Reports**

- 5.1.1. The Contractor must produce two (2) electronic PDF copies of a final report for the TA upon completion of the above noted scope of work. The final report must contain the results of all inspections, testing, manufacturer information, part numbers and details of work completed..

5.1.2. The Contractor must include all associated documentation related to this specification as described H-1 General Notes - Section 5 - Documentation.

**5.2. Spares**

5.2.1. N/A

**5.3. Training**

5.3.1. N/A

**5.4. Manuals**

5.4.1. The Contractor must include all associated manuals related to this specification as described in H-1 General Notes - Section 7 - Manuals.

	MLB	
Spec Item #: E-110	SPECIFICATION	
RE-ORIENT CAPSIZE SWITCH		

## 1. PART 1 - SCOPE

- 1.1. The intent of this specification is to supply a new capsized switch and relocate the capsized switch on the port exhaust.

## 2. PART 2 – REFERENCES

### 2.1. Guidance Drawings/Nameplate Data

- 2.1.1. Drawing Number 47B MLB 259-020 – Exhaust System

### 2.2. Standards

- 2.2.1. See General Notes H-1

### 2.3. Regulations

- 2.3.1. See General Notes H-1

### 2.4. Government Supplied Material

- 2.4.1. N/A

### 2.5. Contractor Supplied Material

- 2.5.1. The Contractor must supply everything that is required to perform the specified work unless otherwise stated, such as but not limited to the following: labour, materials, parts, tools, consumables, equipment, machinery, storage, shelters, staging, rigging, scaffolding, enclosures, power and heating.
- 2.5.2. Refer to Appendix A for List of Original Suppliers or Appendix B for List of Alternate/Additional Suppliers.

## 3. PART 3 – TECHNICAL DESCRIPTION

### 3.1. General

- 3.1.1. The Contractor must ensure prior to any work commencing, that both the Contractor Basic Safety Familiarization and Pre Job Safety Assessment are completed and signed off.
- 3.1.2. The Contractor must remove the existing capsized switch located on the underside of the silencer on the port exhaust.
- 3.1.3. The Contractor must blank off the existing port and create a new port on the top as it is configured on the Starboard exhaust.
- 3.1.4. The Contractor must supply and install a new sensor of the same make and model as the existing sensor.

- 3.1.5. The Contractor must reconnect the existing wiring to the new sensor.
- 3.1.6. The Contractor must demonstrate the operation of the sensor to the Technical Authority and ABS Inspector.

**3.2. Location**

- 3.2.1. Engine room

**3.3. Interferences**

- 3.3.1. The Contractor is responsible for the identification of all interference items, their temporary removal, secure storage, and refitting to the vessel.

**4. PART 4 – PROOF OF PERFORMANCE**

**4.1. Inspection**

- 4.1.1. A visual inspection by the Contractor and TA in attendance, of general workmanship including that of piping, hardware, materials, and coatings must be conducted.

**4.2. Testing**

- 4.2.1. The Contractor must demonstrate the operation of the switch during the trials of the propulsion equipment.

**4.3. Certification**

- 4.3.1. N/A

**5. PART 5 – DELIVERABLES**

**5.1. Drawings/Reports**

- 5.1.1. The Contractor must produce two (2) electronic PDF copies of a final report for the TA upon completion of the above noted scope of work. The final report must contain the results of all inspections, testing, manufacturer information, part numbers and details of work completed..
- 5.1.2. The Contractor must include all associated documentation related to this specification as described H-1 General Notes - Section 5 - Documentation.

**5.2. Spares**

- 5.2.1. N/A

**5.3. Training**

- 5.3.1. N/A

**5.4. Manuals**



- 5.4.1. The Contractor must supply bi-lingual operation and parts manuals describing the system and identifying replacement parts as described in H-1 General Notes - Section 7 - Manuals.

	MLB	
Spec Item #: E-111	SPECIFICATION	
Multifunction Displays and Network Switch		

## 1. PART 1 – SCOPE

- 1.1. The intent of this specification is to remove the existing multifunction displays (MFDs) and replace with new Government-Supplied Material.
- 1.2. This work must be carried out in conjunction with the following:
- 1.2.1.1. ~~Error! Reference source not found.E116 NMEA 2000 Network~~
  - 1.2.1.2. ~~Error! Reference source not found.E112 Radar Scanner~~
  - 1.2.1.3. ~~Error! Reference source not found.E119 Sounder Transducer~~
  - 1.2.1.4. ~~Error! Reference source not found.E127 General Console Arrangement~~

## 2. PART 2 – REFERENCES

### 2.1. Guidance Drawings/Nameplate Data

- 2.1.1.1. Phase I/II/III MLB Existing Equipment Drawing Numbers:
- 2.1.1.2. 47B MLB 426-010-01 – Navigation Radar system– Notes, Reference Drawings & Overview
- 2.1.1.3. 47B MLB 426-010-02 – Nav Radar System - Cable Diagram
- 2.1.1.4. All Phases New Equipment Guidance Drawing:  
47MLB\_VLE\_E&I\_Drawings\_Prelim.pdf

### 2.2. Standards

- 2.2.1. See General Notes H-1

### 2.3. Regulations

- 2.3.1. See General Notes H-1

### 2.4. Government Supplied Material

- 2.4.1.1. Two (2) Simrad NSS9 EVO3S or approved equivalent equipment pending CCG internal procurement. This equipment includes MFD and power cable at a minimum.
- 2.4.1.2. One (1) Simrad NSS12 EVO3S or approved equivalent equipment pending CCG internal procurement. This equipment includes MFD and power cable at a minimum.
- 2.4.1.3. One (1) Simrad NEP-2 or approved equivalent equipment pending CCG internal procurement. This equipment includes Ethernet Hub and power cable at a minimum.

### 2.5. Contractor Supplied Material

- 2.5.1. The Contractor must supply everything that is required to perform the specified work unless otherwise stated, such as but not limited to the following: labour, materials, parts, tools, consumables, equipment, machinery, storage, shelters, staging, rigging, scaffolding, enclosures, power and heating.

### 3. PART 3 – TECHNICAL DESCRIPTION

#### 3.1. General

- 3.1.1. The existing multifunction displays and related Ethernet network switch (if applicable) may be a different make and model from vessel to vessel. The Contractor must disconnect and remove the existing multifunction displays, related Ethernet network switch and all related cabling from the vessel.
- 3.1.2. The Contractor must install the new equipment listed in Section 2 in accordance with OEM instructions and guidance drawings.
- 3.1.3. A Simrad NSS9 EVO3S MFD must be installed in both the open bridge console and the enclosed bridge console in conjunction with **Error! Reference source not found.**~~E127-General Console Arrangement.~~
- 3.1.4. A Simrad NSS12 EVO3S MFD must be installed in the enclosed bridge console in conjunction with **Error! Reference source not found.**~~E127-General Console Arrangement.~~
- 3.1.5. Each MFD must be interfaced and installed in conjunction with **Error! Reference source not found.**~~E116-NMEA Distribution Network~~ equipment.
- 3.1.6. One (1) Simrad NEP-2 Ethernet hub must be interfaced and installed in the enclosed bridge, in conjunction with **Error! Reference source not found.**~~E112-Radar Scanner~~ and **Error! Reference source not found.**~~E120-Depth Finder Transducer~~ equipment.
- 3.1.7. Each MFD must be connected to the Simrad NEP-2 Ethernet hub.

#### 3.2. Location

- 3.2.1. Enclosed bridge and open bridge.

#### 3.3. Interferences

- 3.3.1. The Contractor is responsible for identifying all interference items, their removal, storage and subsequent installation upon approval of the Technical Authority.

### 4. PART 4 – PROOF OF PERFORMANCE

#### 4.1. Inspection

- 4.1.1. All work carried out must be verified correct and approved by the Technical Authority by a complete inspection of the MFD's and network switch installation, with emphasis on the weather proofing of the open bridge MFD.

#### 4.2. Testing

- 4.2.1. Refer to testing in E100: General Electronics and Informatics - Testing
- 4.2.2. The Contractor must demonstrate correct function of each piece of equipment listed in section 2 in accordance with manufacturer's instructions.
- 4.2.3. The Contractor must demonstrate correct function of each piece of equipment in conjunction with Error! Reference source not found.~~E112 Open Array Radar~~, Error! Reference source not found.~~E116 NMEA Distribution Network~~ and Error! Reference source not found.~~E119 Sounder Transducer~~.

#### **4.3. Certification**

- 4.3.1. N/A

### **5. PART 5 - DELIVERABLES**

#### **5.1. Drawings/Reports**

- 5.1.1. The Contractor must produce two (2) electronic PDF copies of a final report for the TA upon completion of the above noted scope of work. The final report must contain the results of all inspections, testing, manufacturer information, part numbers and details of work completed..
- 5.1.2. The Contractor must include all associated documentation related to this specification as described H-1 General Notes - Section 5 – Documentation and E100 General E&I – Section 5 – Drawings/Reports.

#### **5.2. Spares**

- 5.2.1. N/A

#### **5.3. Training**

- 5.3.1. N/A

#### **5.4. Manuals**

- 5.4.1. The Contractor must include all associated manuals related to this specification as described in H-1 General Notes - Section 7 – Manuals.

	MLB	
Spec Item #: E-112	SPECIFICATION	
Open Array Radar		

## 1. PART 1 – SCOPE

- 1.1. The intent of this specification is to remove the existing radar scanner and replace with new Government Supplied Material.
- 1.2. This work must be carried out in conjunction with the following:
  - 1.2.1. ~~Error! Reference source not found.E-111 MFDs and Network Switch~~
  - 1.2.2. ~~Error! Reference source not found.E-116 NMEA Distribution Network~~
  - 1.2.3. ~~Error! Reference source not found.E-128 General Antenna Arrangement~~
  - 1.2.4. H-12 Refurbish Mast and Buoyancy Tank

## 2. PART 2 – REFERENCES

### 2.1. Guidance Drawings/Nameplate Data

- 2.1.1. Phase I/II/III MLB Existing Equipment Drawing Numbers:
  - 2.1.1.1. 47B MLB 426-010-01 – Nav Radar system– Notes, ref drawing's & Overview Drawing
  - 2.1.1.2. 47B MLB 426-010-02 – Nav Radar System - Cable Diagram Drawing
  - 2.1.1.3. 47B MLB 426-010-03 – Nav Radar System - Transceiver and Power supply Drawing
  - 2.1.1.4. 47B MLB 426-010-04 – Nav Radar System - Connection diagram , Enclosed Bridge Drawing
  - 2.1.1.5. 47B MLB 426-010-05 – Navigation Radar System - Connection diagram , Open Bridge Drawing
- 2.1.2. All Phases New Equipment Guidance Drawing:
  - 2.1.2.1. 47MLB\_VLE\_E&I\_Drawings\_Prelim.pdf

### 2.2. Standards

- 2.2.1. See General Notes H-1

### 2.3. Regulations

- 2.3.1. The Contractor must supply Proof of Certification of transmitting radio-navigation equipment in accordance with RSS-238 by Industry Canada (IC) in the form of a Technical Acceptance Certificate (TAC) number for the Open Array Radar, issued by the Certification and Engineering Bureau of Industry Canada, or an Industry Canada recognized body.
- 2.3.2. See General Notes H-1
- 2.4. **Government Supplied Material**

- 2.4.1. One (1) Simrad Halo 4 or approved equivalent, pending internal CCG procurement. This equipment includes radar pedestal, antenna, power/data cable at a minimum.
- 2.4.2. One (1) Simrad RI-12 or approved equivalent pending internal CCG procurement. This equipment includes radar interface module and power cable at a minimum.
- 2.5. **Contractor Supplied Material**
- 2.5.1. The Contractor must supply everything that is required to perform the specified work unless otherwise stated, such as but not limited to the following: labour, materials, parts, tools, consumables, equipment, machinery, storage, shelters, staging, rigging, scaffolding, enclosures, power and heating.

### 3. PART 3 – TECHNICAL DESCRIPTION

#### 3.1. **General**

- 3.1.1. The existing radar scanner may be a different make and model from vessel to vessel. The contractor must disconnect and remove the existing radar scanner and all related cabling from the vessel.
- 3.1.2. The Contractor must protect removed equipment and cabling for reuse by the CCG.
- 3.1.3. All removed equipment and related cabling must be treated as Class A material, and shipped to a location decided upon by the TA. Shipping costs will be via PSPC 1379 action.
- 3.1.4. The Contractor must install the new equipment listed in Section 2 in accordance with OEM instructions and guidance drawings.
- 3.1.5. One (1) Simrad Halo 4 radar scanner must be installed in conjunction with H-12 buoyancy tank in a location clear of any obstructions.
- 3.1.6. The Contractor must remove existing mounting plate and weld a new plate with predrilled bolt pattern as found in radar manufacturer manuals.
- 3.1.7. One (1) Simrad RI-12 must be interfaced and installed in the enclosed bridge, in conjunction with ~~Error! Reference source not found.E111 MFDs and Network Switch~~ and ~~Error! Reference source not found.E116 NMEA Distribution Network~~ equipment.
- 3.1.8. The Contractor must maintain prefabricated cable length when recommended by manufacturer and stow any excess cabling in the survivors cabin in a secure manner.

#### 3.2. **Location**

- 3.2.1. Open bridge and enclosed bridge

#### 3.3. **Interferences**

- 3.3.1. The Contractor is responsible for identifying all interface items, their removal, storage and subsequent installation upon approval of the Technical Authority.

### 4. PART 4 – PROOF OF PERFORMANCE

**4.4. Inspection**

- 4.4.1. All work carried out must be verified correct and approved by the Technical Authority by a complete inspection of the open array radar installation, with emphasis on the radar antenna cable run and grounding connection.

**4.5. Testing**

- 4.5.1. Refer to testing in E100: General Electronics and Informatics - Testing
- 4.5.2. The Contractor must demonstrate correct function of each piece of equipment listed in section 2 in accordance with manufacturer's instructions.
- 4.5.3. The Contractor must demonstrate correct function of each piece of equipment in conjunction with ~~Error! Reference source not found.E111 MFDs and Network Switch~~ and ~~Error! Reference source not found.E116 NMEA Distribution Network~~.

**4.6. Certification**

- 4.6.1. Technical Acceptance Certificate (TAC) number for the Open Array Radar, issued by the Certification and Engineering Bureau of Industry Canada, or an Industry Canada recognized body.

**5. PART 5 – DELIVERABLES****5.1. Drawings/Reports**

- 5.1.1. The Contractor must produce two (2) electronic PDF copies of a final report for the TA upon completion of the above noted scope of work. The final report must contain the results of all inspections, testing, manufacturer information, part numbers and details of work completed..
- 5.1.2. The Contractor must include all associated documentation related to this specification as described H-1 General Notes - Section 5 – Documentation and E100 General E&I – Section 5 – Drawings/Reports.

**5.2. Spares**

- 5.2.1. N/A

**5.3. Training**

- 5.3.1. N/A

**5.4. Manuals**

- 5.4.1. The Contractor must include all associated manuals related to this specification as described in H-1 General Notes - Section 7 – Manuals

	MLB	
Spec Item #: E-113	SPECIFICATION	
Electronic Charting System Displays		

## 1. PART 1 - SCOPE

- 1.1. The intent of this specification is to remove the existing Electronic Charting System displays and replace with new Government Supplied Material.
- 1.2. This work must be carried out in Conjunction with the following:
  - 1.2.1. ~~Error! Reference source not found.E114-ECS PC~~
  - 1.2.2. ~~Error! Reference source not found.E127-General Console Arrangement~~

## 2. PART 2 – REFERENCES

- 2.1. **Guidance Drawings/Nameplate Data**
  - 2.1.1. Phase I/II/III MLB Existing Equipment Drawing Numbers:
    - 2.1.1.1. 47B MLB 426-011-01 – Electronic Chart System , Notes, ref. Drawings, Parts & Cable Drawings
    - 2.1.1.2. 47B MLB 426-011-02 – Electronic Chart System, Cable and Wiring Diagram
  - 2.1.2. All Phases New Equipment Guidance Drawing:
    - 2.1.2.1. 47MLB\_VLE\_E&I\_Drawings\_Prelim.pdf
- 2.2. **Standards**
  - 2.2.1. See General Notes H-1
- 2.3. **Regulations**
  - 2.3.1. N/A
- 2.4. **Government Supplied Material**
  - 2.4.1. Two (2) MarineNav CGElite 12 or approved equivalent equipment pending CCG internal procurement. This equipment includes the display and power cable at a minimum.
- 2.5. **Contractor Supplied Material**
  - 2.5.1. The Contractor must supply everything that is required to perform the specified work unless otherwise stated, such as but not limited to the following: labour, materials, parts, tools, consumables, equipment, machinery, storage, shelters, staging, rigging, scaffolding, enclosures, power and heating.

## 3. PART 3 – TECHNICAL DESCRIPTION

- 3.1. **General**
  - 3.1.1. The Contractor must disconnect and remove the existing ECS display from the enclosed bridge and all related cabling from the vessel.



- 3.1.2. The Contractor must protect removed equipment and cabling for reuse by the CCG.
- 3.1.3. All removed equipment and related cabling must be treated as Class A material, and shipped to a location decided upon by the TA. Shipping costs will be via PSPC 1379 action.
- 3.1.4. The Contractor must install the new equipment listed in Section 2 in accordance with OEM instructions and guidance drawings.
- 3.1.5. A MarineNav CGElite 12 must be interfaced and installed in both the open bridge console and the enclosed bridge console in conjunction with **Error! Reference source not found.E127 General Console Arrangement** and **Error! Reference source not found.E114 ECS PC** equipment.
- 3.2. **Location**
  - 3.2.1. Enclosed bridge and open bridge
- 3.3. **Interferences**
  - 3.3.1. The Contractor is responsible for identifying all interference items, their removal, storage and subsequent installation upon approval of the Technical Authority.

#### **4. PART 4 – PROOF OF PERFORMANCE**

##### **4.1. Inspection**

- 4.1.1. All work carried out must be verified correct and approved by the Technical Authority by a complete inspection of the electronic chart display's installation, with emphasis on the open bridge display weather proofing and equipment grounding connections.

##### **4.2. Testing**

- 4.2.1. Refer to testing in E100: General Electronics and Informatics - Testing
- 4.2.2. The Contractor must demonstrate correct function of each piece of equipment listed in section 2 in accordance with manufacturer's instructions.
- 4.2.3. The Contractor must demonstrate correct function of each piece of equipment in conjunction with **Error! Reference source not found.E114 ECS PC**.

##### **4.3. Certification**

- 4.3.1. N/A

#### **5. PART 5 - DELIVERABLES**

##### **5.1. Drawings/Reports**

- 5.1.1. The Contractor must produce two (2) electronic PDF copies of a final report for the TA upon completion of the above noted scope of work. The final report must contain the results of all inspections, testing, manufacturer information, part numbers and details of work completed..

5.1.2. The Contractor must include all associated documentation related to this specification as described H-1 General Notes - Section 5 – Documentation and E100 General E&I – Section 5 – Drawings/Reports.

**5.2. Spares**

5.2.1. N/A

**5.3. Training**

5.3.1. N/A

**5.4. Manuals**

5.4.1. The Contractor must include all associated manuals related to this specification as described in H-1 General Notes - Section 7 – Manuals.

	MLB	
Spec Item #: E-114	SPECIFICATION	
Electronic Charting System Personal Computer		

## 1. PART 1 - SCOPE

- 1.1. The intent of this specification is to remove the existing Electronic Charting System personal computer (PC) and replace with new Government Supplied Material.
- 1.2. This work must be carried out in Conjunction with the following:
  - 1.2.1. ~~Error! Reference source not found.E113-ECS Displays~~
  - 1.2.2. ~~Error! Reference source not found.E116-NMEA Distribution Network~~
  - 1.2.3. ~~Error! Reference source not found.E118-DGNSS/AIS~~

## 2. PART 2 – REFERENCES

### 2.1. Guidance Drawings/Nameplate Data

- 2.1.1. Phase I/II/III MLB Existing Equipment Drawing Numbers:
  - 2.1.1.1. 47B MLB 426-011-01 – Electronic Chart System, Notes, ref. Drawings, Parts & Cable Drawing
  - 2.1.1.2. 47B MLB 426-011-02 – Electronic Chart System, Cable and Wiring Diagram
- 2.1.2. All Phases New Equipment Guidance Drawing:
  - 2.1.2.1. 47MLB\_VLE\_E&I\_Drawings\_Prelim.pdf

### 2.2. Standards

- 2.2.1. See General Notes H-1

### 2.3. Regulations

- 2.3.1. See General Notes H-1

### 2.4. Government Supplied Material

- 2.4.1. One (1) MarineNav Leviathan 17i Fanless or approved equivalent equipment pending CCG internal procurement. This equipment includes the PC at a minimum.

### 2.5. Contractor Supplied Material

- 2.5.1. The Contractor must supply everything that is required to perform the specified work unless otherwise stated, such as but not limited to the following: labour, materials, parts, tools, consumables, equipment, machinery, storage, shelters, staging, rigging, scaffolding, enclosures, power and heating.

## 3. PART 3 – TECHNICAL DESCRIPTION

### 3.1. General

- 3.1.1. The Contractor must disconnect and remove the existing ECS personal computer from the vessel.

- 3.1.2. The Contractor must retain keyboards, mice, video cables and any Keyboard Video Monitor (KVM) switch or USB extenders for reuse.
- 3.1.3. The Contractor must protect removed equipment and cabling for reuse by the CCG.
- 3.1.4. All removed equipment and related cabling must be treated as Class A material, and shipped to a location decided upon by the TA. Shipping costs will be via PSPC 1379 action.
- 3.1.5. The Contractor must install the new equipment listed in Section 2 in accordance with OEM instructions and guidance drawings.
- 3.1.6. One (1) MarineNav Leviathan 17i Fanless must be interfaced and installed in the enclosed bridge, in conjunction with Error! Reference source not found.E113 ECS Displays, Error! Reference source not found.E116 NMEA Distribution Network and Error! Reference source not found.E118 DGNSS/AIS equipment.
- 3.1.7. The Contractor must ensure ECS input/output cabling connections are properly bundled and tied to secure against vibration causing faulty connections.
- 3.1.8. Where the existing mounting plate is not large enough to mount the new ECS computer, the Contractor must design and manufacture a larger mounting plate of equal thickness to securely mount the computer.

### **3.2. Location**

- 3.2.1. Enclosed bridge and open bridge

### **3.3. Interferences**

- 3.3.1. The Contractor is responsible for identifying all interface items, their removal, storage and subsequent installation upon approval of the Technical Authority.

## **4. PART 4 – PROOF OF PERFORMANCE**

### **4.1. Inspection**

- 4.1.1. All work carried out must be verified correct and approved by the Technical Authority by a complete inspection of the electronic charting system PC installation with emphasis on the secure connection of the input/output cabling.

### **4.2. Testing**

- 4.2.1. Refer to testing in E100: General Electronics and Informatics - Testing
- 4.2.2. The Contractor must demonstrate correct function of each piece of equipment listed in section 2 in accordance with manufacturer's instructions.
- 4.2.3. The Contractor must demonstrate correct function of each piece of equipment in conjunction with Error! Reference source not found.E113 ECS Displays, Error! Reference source not found.E116 NMEA Distribution Network and Error! Reference source not found.E118 DGNSS/AIS.

### **4.3. Certification**

- 4.3.1. N/A

## **5. PART 5 - DELIVERABLES**

**5.1. Drawings/Reports**

5.1.1. The Contractor must produce two (2) electronic PDF copies of a final report for the TA upon completion of the above noted scope of work. The final report must contain the results of all inspections, testing, manufacturer information, part numbers and details of work completed..

5.1.1. The Contractor must include all associated documentation related to this specification as described H-1 General Notes - Section 5 – Documentation and E100 General E&I – Section 5 – Drawings/Reports.

**5.2. Spares**

5.2.1. N/A

**5.3. Training**

5.3.1. N/A

**5.4. Manuals**

5.4.1. The Contractor must include all associated manuals related to this specification as described in H-1 General Notes - Section 7 – Manuals.

	MLB	
Spec Item #: E-115	SPECIFICATION	
Navigation Instrument Displays		

## 1. PART 1 - SCOPE

- 1.1. The intent of this specification is to install new Government Supplied Material (Navigation instrument displays interfaced with the NMEA distribution network). These multi data displays will replace data sensor-specific displays removed in other sections.
- 1.2. This work must be carried out in Conjunction with the following:
- 1.2.1. ~~Error! Reference source not found.E116-NMEA-Distribution-Network~~
- 1.2.2. ~~Error! Reference source not found.E127-General-Console-Arrangement~~

## 2. PART 2 – REFERENCES

### 2.1. Guidance Drawings/Nameplate Data

- 2.1.1. All Phases New Equipment Guidance Drawing:
- 2.1.1.1. 47MLB\_VLE\_E&I\_Drawings\_Prelim.pdf

### 2.2. Standards

- 2.2.1. See General Notes H-1

### 2.3. Regulations

- 2.3.1. See General Notes H-1

### 2.4. Government Supplied Material

- 2.4.1. Four (4) Simrad IS42 or equivalent equipment, pending CCG internal procurement. This equipment includes the displays at a minimum.

### 2.5. Contractor Supplied Material

- 2.5.1. The Contractor must supply everything that is required to perform the specified work unless otherwise stated, such as but not limited to the following: labour, materials, parts, tools, consumables, equipment, machinery, storage, shelters, staging, rigging, scaffolding, enclosures, power and heating.

## 3. PART 3 – TECHNICAL DESCRIPTION

### 3.1. General

- 3.1.1. The Contractor must install the new equipment listed in Section 2 in accordance with OEM instructions and guidance drawings.
- 3.1.2. Two (2) Simrad IS42 navigation instrument displays are to be interfaced and installed in each the open bridge console and the enclosed bridge console, in conjunction with ~~Error! Reference source not found.E127-Open-Bridge-Console-Arrangement~~ and ~~Error! Reference source not found.E116-NMEA-Distribution-Network~~ equipment.

**3.2. Location**

3.2.1. Enclosed bridge and open bridge.

**3.3. Interferences**

3.3.1. The Contractor is responsible for identifying all interference items, their removal, storage and subsequent installation upon approval of the Technical Authority.

**4. PART 4 – PROOF OF PERFORMANCE**

**4.1. Inspection**

4.1.1. All work carried out must be verified correct and approved by the Technical Authority by a complete inspection of the navigation instrument display's installation, with emphasis on the open bridge display(s) weather proofing.

**4.2. Testing**

4.2.1. Refer to testing in E100: General Electronics and Informatics - Testing

4.2.2. The Contractor must demonstrate correct function of each piece of equipment listed in section 2 in accordance with manufacturer's instructions.

4.2.3. The Contractor must demonstrate correct function of each piece of equipment in conjunction with **Error! Reference source not found.**~~E116 NMEA Distribution Network.~~

**4.3. Certification**

4.3.1. N/A

**5. PART 5 - DELIVERABLES**

**5.1. Drawings/Reports**

5.1.1. The Contractor must produce two (2) electronic PDF copies of a final report for the TA upon completion of the above noted scope of work. The final report must contain the results of all inspections, testing, manufacturer information, part numbers and details of work completed..

5.1.2. The Contractor must include all associated documentation related to this specification as described H-1 General Notes - Section 5 – Documentation and E100 General E&I – Section 5 – Drawings/Reports.

**5.2. Spares**

5.2.1. N/A

**5.3. Training**

5.3.1. N/A

**5.4. Manuals**

- 5.4.1. The Contractor must include all associated manuals related to this specification as described in H-1 General Notes - Section 7 – Manuals.



	MLB	
Spec Item #: E-116	SPECIFICATION	
Navigational Marine Electronics Association (NMEA) Distribution Network		

## 1. PART 1 - SCOPE

- 1.1. The intent of this specification is to design and install a new Contractor Supplied Material (NMEA 2000 network that integrates navigation and communication equipment) throughout the vessel.
- 1.2. This work must be carried out in conjunction with the following:
- 1.2.1. ~~Error! Reference source not found.E111 MFDs and Network Switch~~
- 1.2.2. ~~Error! Reference source not found.E114 ECS PC~~
- 1.2.3. ~~Error! Reference source not found.E115 Navigation Instrument Displays~~
- 1.2.4. ~~Error! Reference source not found.E117 Satellite Compass~~
- 1.2.5. ~~Error! Reference source not found.E118 DGNSS/AIS~~
- 1.2.6. ~~Error! Reference source not found.E119 Sounder Transducer~~
- 1.2.7. ~~Error! Reference source not found.E121 Autopilot~~
- 1.2.8. ~~Error! Reference source not found.E123 VHF Radio(s)~~
- 1.2.9. ~~Error! Reference source not found.E124 MF/HF Radio~~
- 1.2.10. ~~Error! Reference source not found.E126 VHF DF~~
- 1.2.11. ~~Error! Reference source not found.E129 Weather Sensor~~

## 2. PART 2 – REFERENCES

### 2.1 Guidance Drawings/Nameplate Data

- 2.1.1. Phase I/II/III MLB Existing Equipment Drawing Numbers:
- 2.1.1.1. N/A
- 2.1.2. All Phases New Equipment Guidance Drawing:
- 2.1.2.1. 47MLB\_VLE\_E&I\_Drawings\_Prelim.pdf

### 2.2. Standards

- 2.2.1. See General Notes H-1
- 2.2.2. National Marine Electronics Association (NMEA)2000 V 3.101 Standard
- 2.2.3. IEC 61162-3:2008 Maritime navigation and radio-communication equipment and systems - Digital interfaces – Part 3: Serial data instrument network.

### 2.3. Regulations

2.3.1. See General Notes H-1

**2.4. Government Supplied Material**

2.4.1. N/A

**2.5. Contractor Supplied Material**

2.5.1. The Contractor must supply everything that is required to perform the specified work unless otherwise stated, such as but not limited to the following: labour, materials, parts, tools, consumables, equipment, machinery, storage, shelters, staging, rigging, scaffolding, enclosures, power and heating.

2.5.2. NMEA 2000 cables and connectors manufactured by Maretron meeting National Marine Electronics Association (NMEA)2000 V 3.101 Standard or IEC 61162-3:2008 Maritime navigation and radio-communication equipment and systems - Digital interfaces – Part 3: Serial data instrument network.

2.5.3. Three (3) NMEA 2000 to NMEA 0183 gateway devices for interface conversion meeting National Marine Electronics Association (NMEA)2000 V 3.101 Standard or IEC 61162-3:2008 Maritime navigation and radio-communication equipment and systems - Digital interfaces – Part 3: Serial data instrument network.

2.5.4. One (1) NMEA 2000 to USB gateway device for interface conversion meeting National Marine Electronics Association (NMEA)2000 V 3.101 Standard or IEC 61162-3:2008 Maritime navigation and radio-communication equipment and systems - Digital interfaces – Part 3: Serial data instrument network.

**3. PART 3 – TECHNICAL DESCRIPTION**

**3.1. General**

3.1.1. The Contractor must install the new equipment listed in Section 2 in accordance with OEM instructions and guidance drawings.

3.1.2. The Contractor must design and install a complete functioning NMEA 2000 network using best practices according to NMEA 2000 V 3.101 or IEC 61162-3:2008 standards.

3.1.3. The Contractor must design NMEA 2000 network to facilitate future expansion of the network in the enclosed bridge, open bridge and survivors cabin.

3.1.4. The NMEA 2000 network must be interfaced and installed in conjunction with equipment shown in the NMEA 2000 One Line guidance drawing.

3.1.5. The NMEA 2000 network must incorporate redundant power supplies.

3.1.6. The Contractor must incorporate NMEA 2000 V 3.101 or IEC 61162-3:2008 approved cables and connectors manufactured by Maretron.

3.1.7. The Contractor must incorporate NMEA 2000 to NMEA 0183 gateway devices when and where required to interface NMEA 0183 equipment with the NMEA 2000 network.

3.1.8. The Contractor must incorporate NMEA 2000 to USB gateway device to interface the NMEA 2000 network with the USB port of the ECS PC.

### 3.2. Location

3.2.1. Throughout the vessel.

### 3.3. Interferences

3.3.1. The Contractor is responsible for identifying all interference items, their removal, storage and subsequent installation upon approval of the Technical Authority.

## 4. PART 4 – PROOF OF PERFORMANCE

### 4.1. Inspection

4.1.1. All work carried out must be verified correct and approved by the Technical Authority by a complete inspection of the NMEA 2000 network installation, with emphasis on appropriate choices of cable size, use of appropriate connectors, and accessibility of the cable run in the enclosed bridge, open bridge and survivors cabin.

### 4.2. Testing

4.2.1. Refer to testing in E100: General Electronics and Informatics - Testing

4.2.2. The Contractor must demonstrate correct function of each piece of equipment listed in section 2 in accordance with manufacturer's instructions.

4.2.3. The Contractor must demonstrate correct function of each piece of equipment in conjunction with the following equipment:

4.2.3.1. Error! Reference source not found.~~E111 MFDs and Network Switch~~

4.2.3.2. Error! Reference source not found.~~E114 ECS PC~~

4.2.3.3. Error! Reference source not found.~~E115 Navigation Instrument Displays~~

4.2.3.4. Error! Reference source not found.~~E117 Satellite Compass~~

4.2.3.5. Error! Reference source not found.~~E118 DGNS/AIS~~

4.2.3.6. Error! Reference source not found.~~E119 Sounder Transducer~~

4.2.3.7. Error! Reference source not found.~~E121 Autopilot~~

4.2.3.8. Error! Reference source not found.~~E123 VHF Radio(s)~~

4.2.3.9. Error! Reference source not found.~~E126 VHF DF~~

4.2.3.10. Error! Reference source not found.~~E129 Weather Sensor~~

### 4.3. Certification

4.3.1. N/A

## 5. PART 5 - DELIVERABLES

**5.1. Drawings/Reports**

- 5.1.1. The Contractor must provide a computer-generated, as-fitted single-line drawing detailing the NMEA 2000 network prior to installation for technical authority approval. This drawing must contain cable numbers and all supplied fittings. Drawing must be provided in digital format.
- 5.1.2. The Contractor must produce two (2) electronic PDF copies of a final report for the TA upon completion of the above noted scope of work. The final report must contain the results of all inspections, testing, manufacturer information, part numbers and details of work completed..
- 5.1.3. The Contractor must include all associated documentation related to this specification as described H-1 General Notes - Section 5 – Documentation and E100 General E&I – Section 5 – Drawings/Reports.

**5.2. Spares**

- 5.2.1. N/A

**5.3. Training**

- 5.3.1. N/A

**5.4. Manuals**

- 5.4.1. The Contractor must include all associated manuals related to this specification as described in H-1 General Notes - Section 7 – Manuals.

	MLB	
Spec Item #: E-117	SPECIFICATION	
Satellite Compass		

## 1. PART 1 – SCOPE

- 1.1. The intent of this specification is to remove the existing heading device and replace with new Contractor Supplied Material.
- 1.2. This work must be carried out in conjunction with the following:
- 1.2.1. ~~Error! Reference source not found.E116 NMEA Distribution Network~~
- 1.2.2. ~~Error! Reference source not found.E128 General Antenna Arrangement~~
- 1.2.3. H-12 Refurbish Mast and Buoyancy Tank

## 2. PART 2 – REFERENCES

### 2.1. Guidance Drawings/Nameplate Data

- 2.1.1. Phase I/II Gyrostar II drawings and Satellite Compass drawing
- 2.1.2. Phase III MLB Existing Equipment Drawing Numbers:
- 2.1.2.1. 47B MLB 426-015-01 FOG Gyro & Mag Compass - Notes, Ref Drawings,
- 2.1.2.2. 47B MLB 426-015-02 FOG Gyro Compass - Block Diagram
- 2.1.2.3. 47B MLB 426-015-03 FOG Gyro Compass - Connection Diagram
- 2.1.3. All Phases New Equipment Guidance Drawing:
- 2.1.3.1. 47MLB\_VLE\_E&I\_Drawings\_Prelim.pdf

### 2.2. Standards

- 2.2.1. See General Notes H-1

### 2.3. Regulations

- 2.3.1. See General Notes H-1

### 2.4. Government Supplied Material

- 2.4.1. N/A

### 2.5. Contractor Supplied Material

- 2.5.1. The Contractor must supply everything that is required to perform the specified work unless otherwise stated, such as but not limited to the following: labour, materials, parts, tools, consumables, equipment, machinery, storage, shelters, staging, rigging, scaffolding, enclosures, power and heating.
- 2.5.2. One (1) Simrad MX575D DGPS Satellite Compass with GLONASS, part number 000-11644-001.
- 2.5.3. One (1) Serial to NMEA 2000 adapter, part number 000-10941-001

### 3. PART 3 – TECHNICAL DESCRIPTION

#### 3.1. General

- 3.1.1. The Contractor must install the new equipment listed in Section 2 in accordance with OEM instructions and guidance drawings.
- 3.1.2. The existing heading device may be a different type: satellite compass, spinning Mass Gyrocompass or fibre optic gyrocompass, from vessel to vessel. The contractor must disconnect and remove the existing heading device, related displays, display dimmers, etc. and all related cabling from the vessel.
- 3.1.3. The Contractor must protect removed equipment and cabling for reuse by the CCG.
- 3.1.4. All removed equipment and related cabling must be treated as CAT A material, and shipped to a location decided upon by the TA. Shipping costs will be via PSPC 1379 action.
- 3.1.5. The Contractor must install the new equipment listed in Section 2 in accordance with OEM instructions and guidance drawings.
- 3.1.6. The Simrad MX575D DGPS Satellite Compass and NMEA 2000 adapter must be installed and interfaced on the vessel brow in conjunction with **Error! Reference source not found.**~~E128 General Antenna Arrangement~~ and **Error! Reference source not found.**~~E116 NMEA Distribution Network~~ equipment.

#### 3.2. Location

- 3.2.1. Vessel brow

#### 3.3. Interferences

- 3.3.1. The Contractor is responsible for identifying all interference items, their removal, storage and subsequent installation upon approval of the Technical Authority.

### 4. PART 4 – PROOF OF PERFORMANCE

#### 4.1. Inspection

- 4.1.1. All work carried out must be verified correct and approved by the Technical Authority by a complete inspection of the satellite compass installation.

#### 4.2. Testing

- 4.3. Refer to testing in E100: General Electronics and Informatics – Testing.

- 4.3.1. The Contractor must demonstrate correct function of each piece of equipment listed in section 2 in accordance with manufacturer's instructions.

- 4.3.2. The Contractor must demonstrate correct function of each piece of equipment in conjunction with **Error! Reference source not found.**~~E116 NMEA Distribution Network~~ equipment.

#### 4.4. Certification

4.5. N/A

**5. PART 5 - DELIVERABLES**

**5.1. Drawings/Reports**

5.1.1. The Contractor must produce two (2) electronic PDF copies of a final report for the TA upon completion of the above noted scope of work. The final report must contain the results of all inspections, testing, manufacturer information, part numbers and details of work completed..

5.1.2. The Contractor must include all associated documentation related to this specification as described H-1 General Notes - Section 5 – Documentation and E100 General E&I – Section 5 – Drawings/Reports.

**5.2. Spares**

5.2.1. N/A

**5.3. Training**

5.3.1. N/A

**5.4. Manuals**

5.4.1. The Contractor must include all associated manuals related to this specification as described in H-1 General Notes - Section 7 – Manuals.

	MLB	
Spec Item #: E-118	SPECIFICATION	
Differential Global Navigation Satellite System and Automatic Identification System (DGNSS and AIS)		

## 1. PART 1 – SCOPE

- 1.1. The intent of this specification is to remove the existing DGNSS and AIS equipment and replace with new Contractor Supplied Material.
- 1.2. This work must be carried out in Conjunction with the following:
- 1.2.1. ~~Error! Reference source not found.E116 NMEA Distribution Network~~
- 1.2.2. ~~Error! Reference source not found.E114 ECS PC~~
- 1.2.3. ~~Error! Reference source not found.E123 VHF Radio(s)~~
- 1.2.4. ~~Error! Reference source not found.E124 MF/HF Radio~~
- 1.2.5. ~~Error! Reference source not found.E127 General Console Arrangement~~
- 1.2.6. ~~Error! Reference source not found.E128 General Antenna Arrangement~~
- 1.2.7. H12 Refurbish Mast and Buoyancy Tank

## 2. PART 2 – REFERENCES

### 2.1. Guidance Drawings/Nameplate Data

- 2.1.1. Phase I/II/III MLB Existing Equipment Drawing Numbers:
- 2.1.1.1. 47B MLB 426-014-01 AIS-DGPS Sys - Notes, Ref Drawings, Parts & Cable Drawing
- 2.1.1.2. 47B MLB 426-014-02 AIS-DGPS Sys – Connection Drawing
- 2.1.1.3. 47B MLB 426-014-01 AIS-DGPS Sys – Integration Connections Drawing
- 2.1.2. All Phases New Equipment Guidance Drawing:
- 2.1.2.1. 47MLB\_VLE\_E&I\_Drawings\_Prelim.pdf

### 2.2. Standards

- 2.2.1. The Contractor must supply Proof of Certification of transmitting radio-navigation equipment in accordance with RSS-182 by Industry Canada (IC) in the form of a Technical Acceptance Certificate (TAC) number for the AIS transponder, issued by the Certification and Engineering Bureau of Industry Canada, or an Industry Canada recognized body.

### 2.3. Regulations

- 2.3.1. N/A

### 2.4. Government Supplied Material

- 2.4.1. N/A

### 2.5. Contractor Supplied Material



- 2.5.1. The Contractor must supply everything that is required to perform the specified work unless otherwise stated, such as but not limited to the following: labour, materials, parts, tools, consumables, equipment, machinery, storage, shelters, staging, rigging, scaffolding, enclosures, power and heating.
- 2.5.2. One (1) Saab R5 Combined AIS and NAV system including all components necessary to make a fully functioning system, including the following at a minimum:
- 2.5.2.1. Saab R5 AIS including:
- 2.5.2.1.1. One (1) Saab R5 AIS Transponder, part number 7000 118-540
  - 2.5.2.1.2. One (1) Saab R5 Control and Display Unit, part number 7000 118-530
  - 2.5.2.1.3. One (1) Saab R5 AIS Junction Box, part number 7000 118-120
  - 2.5.2.1.4. Two (2) R5 Power Cable, part number 7000 118-077
  - 2.5.2.1.5. Two (2) of R5 DSUB-DSUB Signal Cable, part number 7000 118-286
  - 2.5.2.1.6. One (1) Saab Ethernet Cable, part number 7000 00-525
- 2.5.2.2. Saab R5 DGNSS NAV MkII Add-on kit for R5 AIS System, including:
- 2.5.2.2.1. One (1) DGNSS Sensor with Integrated Junction Box, part number 7000 118-771
  - 2.5.2.2.2. One (1) Saab R5 Ethernet Cable, part number 7000 000-525
  - 2.5.2.2.3. One (1) MGL-5 DGNSS Antenna, part number 7000 000-555
- 2.5.2.3. One (1) Combined GPS/AIS antenna, part number 7000 000-435

### **3. PART 3 – TECHNICAL DESCRIPTION**

#### **3.1. General**

- 3.1.1. The existing DGNSS may be different make/model from vessel to vessel and some vessels may not have an AIS. The system display, AIS transponder, Navigation Sensor, related junction boxes, DGNSS antenna, GPS antenna, VHF AIS antenna and all related cabling located in various locations are to be removed from the vessel where applicable. Equipment and cabling must be protected for reuse.
- 3.1.2. All removed equipment and related cabling must be treated as Class A material and shipped to a location decided upon by the TA. Shipping costs will be via PSPC 1379 action.
- 3.1.3. The Contractor must install the new equipment listed in Section 2 in accordance with OEM instructions and guidance drawings.

- 3.1.4. The Saab R5 Control and Display unit must be installed in the enclosed bridge console in conjunction with Error! Reference source not found.E127 General Console Arrangement.
- 3.1.5. The Saab R5 AIS transponder, AIS junction box, DGNSS Sensor with Integrated Junction Box and related cabling are to be installed in the survivors cabin.
- 3.1.6. The DGNSS, GNSS and VHF AIS antenna are to be installed on the vessel brow in conjunction with Error! Reference source not found.E127 General Antenna Arrangement.
- 3.1.7. The Saab R5 Combined AIS and Nav system must be interfaced and installed in conjunction with Error! Reference source not found.E116 NMEA Distribution Network, Error! Reference source not found.E123 VHF Radio(s), Error! Reference source not found.E124 MF/HF Radio and Error! Reference source not found.E114 ECS PC.

### 3.2. Location

- 3.2.1. Enclosed bridge, survivors cabin and vessel brow.

### 3.3. Interferences

- 3.3.1. The Contractor is responsible for identifying all interference items, their removal, storage and subsequent installation upon approval of the Technical Authority.

## 4. PART 4 – PROOF OF PERFORMANCE

### 4.1. Inspection

- 4.1.1. All work carried out must be verified correct and approved by the Technical Authority.

### 4.2. Testing

- 4.2.1. Refer to testing in E100: General Electronics and Informatics – Testing.
- 4.2.2. The Contractor must demonstrate correct function of each piece of equipment listed in section 2 in accordance with manufacturer's instructions.
- 4.2.3. The Contractor must demonstrate correct function of each piece of equipment in conjunction with Error! Reference source not found.E116 NMEA Distribution Network, Error! Reference source not found.E123 VHF Radio(s), Error! Reference source not found.E124 MF/HF Radio, Error! Reference source not found.E126 VHF DF and Error! Reference source not found.E114 ECS PC.

### 4.3. Certification

- 4.3.1. Technical Acceptance Certificate (TAC) number for the AIS transponder, issued by the Certification and Engineering Bureau of Industry Canada, or an Industry Canada recognized body.

## 5. PART 5 – DELIVERABLES

**5.1. Drawings/Reports**

- 5.1.1. The Contractor must produce two (2) electronic PDF copies of a final report for the TA upon completion of the above noted scope of work. The final report must contain the results of all inspections, testing, manufacturer information, part numbers and details of work completed..
- 5.1.2. The Contractor must include all associated documentation related to this specification as described H-1 General Notes - Section 5 – Documentation and E100 General E&I – Section 5 – Drawings/Reports.

**5.2. Spares**

- 5.2.1. N/A

**5.3. Training**

- 5.3.1. N/A

**5.4. Manuals**

- 5.4.1. The Contractor must include all associated manuals related to this specification as described in H-1 General Notes - Section 7 – Manuals.

	MLB	
Spec Item #: E-119	SPECIFICATION	
Sounder Transducer		

## 1. PART 1 - SCOPE

- 1.1. The intent of this specification is to remove the existing echo sounder and replace with new Contractor Supplied Material.
- 1.2. This work must be carried out in Conjunction with the following:
- 1.2.1. **Error! Reference source not found.** E-111 MFDs and Network Switch
- 1.2.2. H-7 Hull Inspection and Inserts
- 1.2.3. H-14 Replace Through Hull Connections

## 2. PART 2 – REFERENCES

### 2.1. Guidance Drawings/Nameplate Data

- 2.1.1. Phase I/II drawings and Western region drawing.
- 2.1.2. Phase III MLB Existing Equipment Drawing Numbers:
- 2.1.2.1. 47B MLB 426-12-01 – Echo Sounder . Notes , parts & cable list
- 2.1.2.2. 47B MLB 426-12-02- Echo Sounder Cable, and wiring diagram
- 2.1.3. All Phases New Equipment Guidance Drawing:
- 2.1.3.1. 47MLB\_VLE\_E&I\_Drawings\_Prelim.pdf

### 2.2. Standards

- 2.2.1. See General Notes H-1

### 2.3. Regulations

- 2.3.1. See General Notes H-1

### 2.4. Government Supplied Material

- 2.4.1. N/A

### 2.5. Contractor Supplied Material

- 2.5.1. The Contractor must supply everything that is required to perform the specified work unless otherwise stated, such as but not limited to the following: labour, materials, parts, tools, consumables, equipment, machinery, storage, shelters, staging, rigging, scaffolding, enclosures, power and heating.
- 2.5.2. One (1) Transducer Airmar SS175M-20
- 2.5.3. One (1) Stainless Steel Transducer housing provided with the transducer

## 3. PART 3 – TECHNICAL DESCRIPTION

### 3.1. General

- 3.1.1. The existing sounder display and related transducer may be a different make and model from vessel to vessel. The Contractor must disconnect and remove the existing sounder display, related transducer, transducer fairing block housing and all related cabling from the vessel. Equipment and cabling must be protected for reuse.
- 3.1.2. All removed equipment and related cabling must be treated as Class A material and shipped to a location decided upon by the TA. Shipping costs will be via PSPC 1379 action.
- 3.1.3. One (1) Airmar SS175M-20 and one (1) Stainless Steel Transducer housing must be interfaced and installed flush with the hull in conjunction with E111 MFDs and Network Switch and H-14 Hull Inspection and Inserts.
- 3.1.4. The sounder transducer must be compatible with, interfaced and installed in conjunction with multifunction display and network switch in section **Error! Reference source not found.**~~E111 MFDs and Network Switch.~~
- 3.1.5. The sounder must not cause interference on the depth finder transducer in section **Error! Reference source not found.**~~E120 Depth Finder Transducer.~~

### **3.2. Location**

- 3.2.1. Hull

### **3.3. Interferences**

- 3.3.1. The Contractor is responsible for identifying all interference items, their removal, storage and subsequent installation upon approval of the Technical Authority.

## **4. PART 4 – PROOF OF PERFORMANCE**

### **4.1. Inspection**

- 4.1.1. All work carried out to be verified correct by the Technical Authority by a complete inspection of the transducer during dry dock, with emphasis on ensuring:
  - 4.1.1.1. That the transducer faces are flush with the hull;
  - 4.1.1.2. That the angle of the transducer face is in accordance with manufacturer's specifications;
  - 4.1.1.3. That the hull within two (2) metres of the transducer is free from cavities and/or protuberances, which might cause turbulence; and
  - 4.1.1.4. That the transducer faces are cleaned and free from paint;

### **4.2. Testing**

- 4.2.1. Refer to testing in E100: General Electronics and Informatics – Testing.
- 4.2.2. The Contractor must demonstrate correct function of each piece of equipment listed in section 2 in accordance with manufacturer's instructions.

4.2.3. The Contractor must demonstrate correct function of the sounder on each MFD in section ~~**Error! Reference source not found.**E111 MFDs and Network Switch.~~

4.2.4. The Contractor must demonstrate correct simultaneous function of both the depth finder in section ~~**Error! Reference source not found.**E120 Depth Finder/Speed/Temperature Transducer~~ and the depth sounder.

### **4.3. Certification**

4.3.1. N/A

## **5. PART 5 – DELIVERABLES**

### **5.1. Drawings/Reports**

5.1.1. The Contractor must produce two (2) electronic PDF copies of a final report for the TA upon completion of the above noted scope of work. The final report must contain the results of all inspections, testing, manufacturer information, part numbers and details of work completed..

5.1.2. The Contractor must include all associated documentation related to this specification as described H-1 General Notes - Section 5 – Documentation and E100 General E&I – Section 5 – Drawings/Reports.

### **5.2. Spares**

5.2.1. N/A

### **5.3. Training**

5.3.1. N/A

### **5.4. Manuals**

5.4.1. The Contractor must include all associated manuals related to this specification as described in H-1 General Notes - Section 7 – Manuals.

	MLB	
Spec Item #: E-120	SPECIFICATION	
Depth/Speed/Temperature Sensor		

## 1. PART 1 – SCOPE

- 1.1. The intent of this specification must remove the Depth/Speed/Temperature displays and sensor and replace with a new Contractor Supplied Material (Multi-sensor interfaced with the NMEA 2000 network).
- 1.2. This work must be carried out in Conjunction with the following:
- 1.2.1.1. **Error! Reference source not found.**~~E116 NMEA Distribution Network~~
- 1.2.1.2. H-14 Hull Inspection and Inserts.

## 2. PART 2 – REFERENCES

### 2.1. Guidance Drawings/Nameplate Data

- 2.1.1. Phase I/II/III MLB Existing Equipment Drawing Numbers:
- 2.1.1.1. 47B MLB 426-13-01 – Echo Sounder . Notes , parts & cable list
- 2.1.1.2. 47B MLB 426-13-02- Echo Sounder Cable, and wiring diagram
- 2.1.2. All Phases New Equipment Guidance Drawing:
- 2.1.2.1. 47MLB\_VLE\_E&I\_Drawings\_Prelim.pdf

### 2.2. Standards

- 2.2.1. See General Notes H-1
- 2.2.2. National Marine Electronics Association (NMEA)2000 V 3.101 Standard
- 2.2.3. IEC 61162-3:2008 Maritime navigation and radio-communication equipment and systems - Digital interfaces – Part 3: Serial data instrument network.

### 2.3. Regulations

- 2.3.1. See General Notes H-1

### 2.4. Government Supplied Material

- 2.4.1. N/A

### 2.5. Contractor Supplied Material

- 2.5.1. The Contractor must supply everything that is required to perform the specified work unless otherwise stated, such as but not limited to the following: labour, materials, parts, tools, consumables, equipment, machinery, storage, shelters, staging, rigging, scaffolding, enclosures, power and heating.
- 2.5.2. One (1) Transducer Airmar UDST800
- 2.5.3. One (1) Stainless Steel Transducer housing Airmar SS617V

## 3. PART 3 – TECHNICAL DESCRIPTION

### 3.1. General

- 3.1.1. The Contractor must disconnect and remove the existing Raymarine instrument display from the enclosed bridge and open bridge, depth/speed/temperature sensor and all related cabling from the vessel. Equipment and cabling must be protected for reuse.
- 3.1.2. All removed equipment and related cabling must be treated as Class A material and shipped to a location decided upon by the TA. Shipping costs will be via PSC 1379 action.
- 3.1.3. One (1) Airmar UDST800 and one (1) Stainless Steel Transducer housing Airmar SS617V must be interfaced and installed flush with the hull in conjunction with E116 NMEA Distribution Network and H-14 Hull Inspection and Inserts.
- 3.1.4. Depth/Speed/Temperature sensor must not cause interference on the depth sounder transducer in section Error! Reference source not found.~~E119 Sounder Transducer.~~

### 3.2. Location

- 3.2.1. Hull

### 3.3. Interferences

- 3.3.1. The Contractor is responsible for the identification of all interference items, their temporary removal, secure storage and refitting to the vessel.

## 4. PART 4 – PROOF OF PERFORMANCE

### 4.1. Inspection

- 4.1.1. All work carried out to be verified correct and approved by the Technical Authority by a complete inspection of the transducer during dry dock, with emphasis on ensuring:
  - 4.1.1.1. That the transducer faces are flush with the hull;
  - 4.1.1.2. That the direction and angle of the transducer face is in accordance with manufacturer's specifications;
  - 4.1.1.3. That the hull within two (2) metres of the transducer is free from cavities and/or protuberances, which might cause turbulence; and
  - 4.1.1.4. That the transducer faces are cleaned and free from paint;

### 4.2. Testing

- 4.2.1. Refer to testing in E100: General Electronics and Informatics – Testing.
- 4.2.2. The Contractor must demonstrate correct function of each piece of equipment listed in section 2 in accordance with manufacturer's instructions.
- 4.2.3. The Contractor must demonstrate correct function of the depth/speed/temperature sensor in conjunction with E116 NMEA Distribution Network equipment.



4.2.4. The Contractor must demonstrate correct simultaneous function of both the depth sounder in section ~~Transducer~~ **Error! Reference source not found.** ~~E119 Sounder~~ **Error! Reference source not found.** and the depth/speed/temperature sensor.

**4.3. Certification**

4.3.1. N/A

**5. PART 5 - DELIVERABLES**

**5.1. Drawings/Reports**

5.1.1. The Contractor must produce two (2) electronic PDF copies of a final report for the TA upon completion of the above noted scope of work. The final report must contain the results of all inspections, testing, manufacturer information, part numbers and details of work completed..

5.1.2. The Contractor must include all associated documentation related to this specification as described H-1 General Notes - Section 5 – Documentation and E100 General E&I – Section 5 – Drawings/Reports.

**5.2. Spares**

5.2.1. N/A

**5.3. Training**

5.3.1. N/A

**5.4. Manuals**

5.4.1. The Contractor must include all associated manuals related to this specification as described in H-1 General Notes - Section 7 – Manuals

	MLB	
Spec Item #: E-121	SPECIFICATION	
Autopilot		

## 1. PART 1 – SCOPE

- 1.1. The intent of this specification is to remove the existing autopilot and replace with new Government Supplied Material.
- 1.2. This work must be carried out in conjunction with the following:
- 1.2.1.1. ~~Error! Reference source not found.E116-NMEA-Distribution-Network~~
  - 1.2.1.2. ~~Error! Reference source not found.E127-General-Console-Arrangement~~
  - 1.2.1.3. M58 Replace Steering Components

## 2. PART 2 – REFERENCES

### 2.1. Guidance Drawings/Nameplate Data

- 2.1.1. Phase I/II/III MLB Existing Equipment Drawing Numbers:
- 2.1.1.1. 47B MLB 426-016-01 Autopilot System - Notes, Ref Drawings, Parts
  - 2.1.1.2. 47B MLB 426-016-02 Autopilot System – Block diagram
  - 2.1.1.3. 47B MLB 426-016-03 Autopilot System – Connection Diagram, open and enclosed Bridge
  - 2.1.1.4. 47B MLB 426-016-04 Autopilot System – Connection Diagram, Eng Rm
- 2.1.2. All Phases New Equipment Guidance Drawing:
- 2.1.2.1. 47MLB\_VLE\_E&I\_Drawings\_Prelim.pdf

### 2.2. Standards

- 2.2.1. See General Notes H-1

### 2.3. Regulations

- 2.3.1. See General Notes H-1

### 2.4. Government Supplied Material

- 2.4.1. One (1) Simrad RF25N or equivalent equipment pending CCG internal procurement. This equipment includes rudder feedback unit and NMEA 2000 interface cable at a minimum.
- 2.4.2. One (1) Simrad NAC-3 or equivalent equipment pending CCG internal procurement. This equipment includes an autopilot computer at a minimum.
- 2.4.3. One (1) Simrad AP48 or equivalent equipment pending CCG internal procurement. This equipment includes an autopilot control unit at a minimum.
- 2.4.4. One (1) Simrad FU80 or equivalent equipment pending CCG internal procurement.

### 2.5. Contractor Supplied Material

- 2.5.1. The Contractor must supply everything that is required to perform the specified work unless otherwise stated, such as but not limited to the following: labour, materials, parts, tools, consumables, equipment, machinery, storage, shelters, staging, rigging, scaffolding, enclosures, power and heating.
- 2.5.2. Autopilot hydraulic steering pump drive unit that is compatible with the government supplied autopilot system and the HyproMarine steering gear.

### 3. PART 3 – TECHNICAL DESCRIPTION

#### 3.1. General

- 3.1.1. The existing Comnav 2001 Autopilot System and all related cabling must be removed from the vessel. Equipment and cabling must be protected for reuse.
- 3.1.2. All removed equipment and related cabling must be treated as Class A material and shipped to a location decided upon by the TA. Shipping costs will be via PSPC 1379 action.
- 3.1.3. The Contractor must install the new equipment listed in Section 2 in accordance with OEM instructions and guidance drawings.
- 3.1.4. One (1) Simrad NAC-3 must be interfaced and installed in the lazarette in conjunction with Error! Reference source not found.~~E116 NMEA Distribution Network.~~
- 3.1.5. One (1) Simrad AP48 must be interfaced and installed in the enclosed bridge, in conjunction with Error! Reference source not found.~~E116 NMEA Distribution Network~~ and Error! Reference source not found.~~E127 General Console Arrangement.~~
- 3.1.6. One (1) Simrad FU80 must be interfaced and installed on the open bridge in conjunction with Error! Reference source not found.~~E116 NMEA Distribution Network.~~
- 3.1.7. Contractor to select and install a steering pump drive system compatible with Simrad autopilot and the vessel steering system located in the lazarette. The Contractor must ensure all Purchase Orders are approved by the Technical Authority prior to being issued to the supplier.
- 3.1.8.

#### 3.2. Location

- 3.2.1. Enclosed bridge, open bridge, lazarette

#### 3.3. Interferences

- 3.3.1. The Contractor is responsible for the identification of all interference items, their temporary removal, secure storage and refitting to the vessel.

### 4. PART 4 – PROOF OF PERFORMANCE

#### 4.1. Inspection

4.1.1. All work carried out to be verified correct by the Technical Authority by a complete inspection of the autopilot installation.

**4.2. Testing**

4.2.1. Refer to testing in E100: General Electronics and Informatics – Testing.

4.2.2. The Contractor must demonstrate correct function of each piece of equipment listed in section 2 in accordance with manufacturer's instructions.

4.2.3. The Contractor must demonstrate correct function of each piece of equipment in conjunction with E116 NMEA Distribution Network and the steering system.

**4.3. Certification**

4.3.1. N/A

**5. PART 5 - DELIVERABLES**

**5.1. Drawings/Reports**

5.1.1. The Contractor must produce two (2) electronic PDF copies of a final report for the TA upon completion of the above noted scope of work. The final report must contain the results of all inspections, testing, manufacturer information, part numbers and details of work completed..

5.1.2. The Contractor must include all associated documentation related to this specification as described H-1 General Notes - Section 5 – Documentation and E100 General E&I – Section 5 – Drawings/Reports.

**5.2. Spares**

5.2.1. N/A

**5.3. Training**

5.3.1. N/A

**5.4. Manuals**

5.4.1. The Contractor must include all associated manuals related to this specification as described in H-1 General Notes - Section 7 – Manuals.

	MLB	
Spec Item #: E-122	SPECIFICATION	
Integrated Communications System		

## 1. PART 1 – SCOPE

- 1.1. The intent of this specification is to remove the existing communications system integrated with a VHF radio, secure tactical radio and air-to-ground radio and replace with new Contractor Supplied Material.
- 1.2. This work must be carried out in Conjunction with the following:
- 1.2.1.1. **Error! Reference source not found.** ~~E123 VHF Radio(s)~~

## 2. PART 2 – REFERENCES

### 2.1. Guidance Drawings/Nameplate Data

- 2.1.1. Phase I/II/III MLB Existing Equipment Drawing Numbers:
- 2.1.1.1. 47B MLB 440-021-01 – Integrated Communication System – notes, ref
- 2.1.1.2. 47B MLB 440-021-02 – Integrated Comm System – Cable Diagram
- 2.1.1.3. 47B MLB 440-021-03 – Integrated Comm System – Connection diagram
- 2.1.2. All Phases New Equipment Guidance Drawing:
- 2.1.2.1. 47MLB\_VLE\_E&I\_Drawings\_Prelim.pdf

### 2.2. Standards

- 2.2.1. See General Notes H-1

### 2.3. Regulations

- 2.3.1. See General Notes H-1

### 2.4. Government Supplied Material

- 2.4.1. N/A

### 2.5. Contractor Supplied Material

- 2.5.1. The Contractor must supply everything that is required to perform the specified work unless otherwise stated, such as but not limited to the following: labour, materials, parts, tools, consumables, equipment, machinery, storage, shelters, staging, rigging, scaffolding, enclosures, power and heating.
- 2.5.2. David Clark System 9100 including the following at a minimum:
- 2.5.2.1. One (1) Master Station (Includes 1xU9101 switch card), part number 4400G-01
- 2.5.2.2. One (1) Master Station Power Cord 20ft. (C91-20PW), part number 40892G-20

- 2.5.2.3. Four (4) Communication Headset determined by technical authority prior to ordering
- 2.5.2.4. Four (4) BELT STATION Smart VOX - MODEL (U9110-BSW), part number 40992G-20
- 2.5.2.5. Eight (8) LI POLYMER BATTERY, part number 40688G-90
- 2.5.2.6. One (1) WIRELESS GATEWAY - (U9120-W4), part number 44002G-02
- 2.5.2.7. One (1) Battery Charger A99-14CGR, part number 41034G-02
- 2.5.2.8. One (1) Charger Power Cord 110VAC (C99-141) 110VAC, part number 41090G-14
- 2.5.2.9. 100 feet Ethernet Cable Heavy Duty, part number 09271P-58
- 2.5.2.10. Four (4) RJ-45 IP-68 connector, part number 13199P-66
- 2.5.2.11. Two (2) Dual Radio with Aux card (U9102), part number 44003G-02
- 2.5.2.12. Four (4) Radio interface cable (C91-20RD), part number 40892G-20
- 2.5.2.13. Four (4) Auxiliary Interface Cable (C91-20AX), part number 20892G-21
- 2.5.2.14. One (1) Remote Antenna Kit with cable R-SMA cable, part number 40688G-96
- 2.5.2.15. One (1) Cell Phone plug in adapter

### **3. PART 3 – TECHNICAL DESCRIPTION**

#### **3.1. General**

- 3.1.1. The existing David Clark integrated communications system may be a wired or wireless type from vessel to vessel. The contractor must disconnect and remove the existing David Clark integrated communications system and all related cabling from throughout the vessel.
- 3.1.2. The Contractor must install the new equipment listed in Section 2 in accordance with OEM instructions and guidance drawings.
- 3.1.3. The David Clark System must be interfaced and installed in conjunction with VHF Radio FM No. 1 and VHF FM Wideband in section **Error! Reference source not found.**~~E123 VHF Radio(s)~~, and the existing Bendix King KY196A air-to-ground radio located in the enclosed bridge.

#### **3.2. Location**

- 3.2.1. Throughout the vessel

#### **3.3. Interferences**

- 3.3.1. The Contractor is responsible for the identification of all interference items, their temporary removal, secure storage and refitting to the vessel.

#### **4. PART 4 – PROOF OF PERFORMANCE**

##### **4.1. Inspection**

4.1.1. All work carried out to be verified correct and approved by the Technical Authority by a complete inspection of the integrated communications system.

##### **4.2. Testing**

4.2.1. Refer to testing in E100: General Electronics and Informatics – Testing.

4.2.2. The Contractor must demonstrate correct function of each piece of equipment listed in section 2 in accordance with manufacturer's instructions.

4.2.3. The Contractor must demonstrate correct function of each piece of equipment in conjunction with **Error! Reference source not found.**~~E123 VHF Radio(s)~~ and the Bendix King KY196A air-to-ground radio.

##### **4.3. Certification**

4.3.1. N/A

#### **5. PART 5 - DELIVERABLES**

##### **5.1. Drawings/Reports**

5.1.1. The Contractor must produce two (2) electronic PDF copies of a final report for the TA upon completion of the above noted scope of work. The final report must contain the results of all inspections, testing, manufacturer information, part numbers and details of work completed..

5.1.2. The Contractor must include all associated documentation related to this specification as described H-1 General Notes - Section 5 – Documentation and E100 General E&I – Section 5 – Drawings/Reports.

##### **5.2. Spares**

5.2.1. N/A

##### **5.3. Training**

5.3.1. N/A

##### **5.4. Manuals**

5.4.1. The Contractor must include all associated manuals related to this specification as described in H-1 General Notes - Section 7 – Manuals.

	MLB	
Spec Item #: E-123	SPECIFICATION	
VHF Radio(s)		

## 1. PART 1 – SCOPE

- 1.1. The intent of this specification is to remove the existing VHF radiotelephone(s) and replace with new Contractor Supplied Material.
- 1.2. This work must be carried out in Conjunction with the following:
- 1.2.1.1. ~~Error! Reference source not found.E116-NMEA Distribution Network~~
  - 1.2.1.2. ~~Error! Reference source not found.E127-General Console Arrangement~~
  - 1.2.1.3. ~~Error! Reference source not found.E128-General Antenna Arrangement~~
  - 1.2.1.4. H12 Refurbish Mast and Buoyancy Tank

## 2. PART 2 – REFERENCES

### 2.1. Guidance Drawings/Nameplate Data

- 2.1.1. Phase I/II/III MLB Existing Equipment Drawing Numbers:
- 2.1.1.1. 47B MLB 440-012-01 VHF FM No 1 Sys - Notes, Ref Drawings, Parts
  - 2.1.1.2. 47B MLB 440-012-01 VHF FM No 1 Sys – Cable Diagram & Wiring diagram
  - 2.1.1.3. 47B MLB 440-013-01 VHF FM Wideband Sys - Notes, Ref Drawings, Parts
  - 2.1.1.4. 47B MLB 440-013-02 VHF FM Wideband Sys – Block & Connection Diagram
  - 2.1.1.5. 47B MLB 440-014-01 VHF FM No 2 Sys - Notes, Ref Drawings, Parts
  - 2.1.1.6. 47B MLB 440-014-02 VHF FM No 2 Sys – Block & Connection Diagram
- 2.1.2. All Phases New Equipment Guidance Drawing:
- 2.1.2.1. 47MLB\_VLE\_E&I\_Drawings\_Prelim.pdf

### 2.2. Standards

- 2.2.1. The Contractor must supply Proof of Certification of transmitting radio-navigation equipment in accordance with RSS-182 by Industry Canada (IC) in the form of a Technical Acceptance Certificate (TAC) number for the AIS transponder, issued by the Certification and Engineering Bureau of Industry Canada, or an Industry Canada recognized body.
- 2.2.2. See General Notes H-1

### 2.3. Regulations

- 2.3.1. See General Notes H-1

### 2.4. Government Supplied Material



- 2.4.1. One (1) Motorola APX-8500 (VHF FM Wideband)
- 2.4.2. Two (2) Microphone
- 2.4.3. Two (2) Control Head
- 2.4.4. One (1) NonWater Resistant Speaker Motorola HSN4032
- 2.4.5. Three (3) Water Resistant Speaker Motorola HSN4040

**2.5. Contractor Supplier Material**

- 2.5.1. The Contractor must supply everything that is required to perform the specified work unless otherwise stated, such as but not limited to the following: labour, materials, parts, tools, consumables, equipment, machinery, storage, shelters, staging, rigging, scaffolding, enclosures, power and heating.
- 2.5.2. One (1) Icom IC-M506 PLUS or approved equivalent by the CCG Technical Authority. This equipment includes VHF radio, PTT mic and power cable at a minimum.
- 2.5.3. One (1) Icom HM-195 or approved equivalent by the CCG Technical Authority. This equipment is a control unit for the Icom IC-M506.
- 2.5.4. One (1) Icom IC-M400BB or approved equivalent by the CCG Technical Authority. This equipment includes a transceiver and HM-195 control unit at a minimum.
- 2.5.5. Three (3) Sinclair sc225M Antennas
- 2.5.6. LMR-400 cabling and connectors for RF transmission lines.

**3. PART 3 – TECHNICAL DESCRIPTION**

**3.1. General**

- 3.1.1. The Contractor must ensure prior to any work commencing that both the Contractor Basic Safety Familiarization and Pre Job Safety Assessment are completed and signed off.
- 3.1.2. All required material must be Contractor supply, approved for the intended use and be of industrial marine quality.
- 3.1.3. The Contractor must ensure all Purchase Orders are approved by the Technical Authority prior to being issued to the supplier.
- 3.1.4. The Contractor must disconnect and remove the existing VHF FM no. 1 radiotelephone located in the enclosed bridge and the VHF antenna from the mast and all related cabling. Equipment and cabling must be protected for reuse.
- 3.1.5. The Contractor must disconnect and remove the existing VHF FM Wideband radiotelephone located in the enclosed bridge and the VHF antenna from the mast and all related cabling. Equipment and cabling must be protected for reuse.

- 3.1.6. The Contractor must disconnect and remove the existing VHF FM no. 2 radiotelephone located in the open bridge console and the VHF antenna from the mast and all related cabling. Equipment and cabling must be protected for reuse.
- 3.1.7. All removed equipment and related cabling must be treated as Class A material and shipped to a location decided upon by the TA. Shipping costs will be via PSCP 1379 action.
- 3.1.8. The Contractor must install the new equipment listed in Section 2 in accordance with OEM instructions and guidance drawings.
- 3.1.9. One (1) ICOM IC-M400 BB (VHF FM No. 2) transceiver must be installed in the enclosed bridge with a control head installed in the open bridge in conjunction with **Error! Reference source not found.**~~E127 General Console Arrangement~~
- 3.1.10. One (1) ICOM IC-M506 (VHF FM No. 1) and HM-195 control head must be installed in the enclosed bridge in conjunction with **Error! Reference source not found.**~~E127 General Console Arrangement.~~
- 3.1.11. One (1) Motorola APX-8500 (VHF FM Wideband) must be installed in the enclosed bridge in conjunction with **Error! Reference source not found.**~~E127 General Console Arrangement~~
- 3.1.12. Three (3) Sinclair SC225M Antenna must be installed on the mast in conjunction with **Error! Reference source not found.**~~E128 General Antenna Arrangement~~ with one antenna connected to each radio.
- 3.1.13. Three (3) speakers with IP 67 rating on the open bridge at a location agreed to by the technical authority, with one (1) speaker connected to each radio.
- 3.1.14. One (1) speaker must be installed in the enclosed bridge on the deckhead at a location agreed to by the technical authority, with one (1) speaker connected to VHF FM Wideband.
- 3.1.15. All speakers must be selected to match the impedance and output power requirements of the radio it is connected to.
- 3.1.16. VHF FM No. 1 and VHF FM Wideband radiotelephones are to be interfaced and installed in conjunction with **Error! Reference source not found.**~~E122 Integrated Communications System (Wireless).~~

## **3.2. Location**

- 3.2.1. Enclosed bridge, open bridge and mast.

## **3.3. Interferences**

- 3.3.1. The Contractor is responsible for the identification of all interference items, their temporary removal, secure storage and refitting to the vessel.

## **4. PART 4 – PROOF OF PERFORMANCE**

### **4.1. Inspection**

4.1.1. All work carried out to be verified correct and approved by the Technical Authority by a complete inspection of the VHF radio installations.

**4.2. Testing**

4.2.1. Refer to testing in E100: General Electronics and Informatics – Testing.

4.2.2. The Contractor must demonstrate correct function of each piece of equipment listed in section 2 in accordance with manufacturer's instructions.

4.2.3. The Contractor must demonstrate correct function of VHF FM No. 1 VHF Wideband equipment in conjunction with **Error! Reference source not found.**~~E122 Integrated Communications System (Wireless).~~

**4.3. Certification**

4.3.1. Technical Acceptance Certificate (TAC) number for the VHF radios, issued by the Certification and Engineering Bureau of Industry Canada, or an Industry Canada recognized body.

**5. PART 5 - DELIVERABLES**

**5.1. Drawings/Reports**

5.1.1. The Contractor must produce two (2) electronic PDF copies of a final report for the TA upon completion of the above noted scope of work. The final report must contain the results of all inspections, testing, manufacturer information, part numbers and details of work completed..

5.1.2. The Contractor must include all associated documentation related to this specification as described H-1 General Notes - Section 5 – Documentation and E100 General E&I – Section 5 – Drawings/Reports.

**5.2. Spares**

5.2.1. N/A

**5.3. Training**

5.3.1. N/A

**5.4. Manuals**

5.4.1. The Contractor must include all associated manuals related to this specification as described in H-1 General Notes - Section 7 – Manuals

	MLB	
Spec Item #: E-124	SPECIFICATION	
MF/HF Radio		

## 1. PART 1 – SCOPE

- 1.1. The intent of this specification is to remove the existing MF/HF radiotelephone and replace with new Contractor Supplied Material.
- 1.2. This work must be carried out in conjunction with the following:
- 1.2.1.1. **Error! Reference source not found.**~~E128 General Antenna Arrangement~~
  - 1.2.1.2. H12 Refurbish Mast and Buoyancy Tank
  - 1.2.1.3. E118 Combined Differential Global Navigation Satellite System and Automatic Identification System (DGNSS/AIS)

## 2. PART 2 – REFERENCES

### 2.1. Guidance Drawings/Nameplate Data

- 2.1.1. Phase I/II/III MLB Existing Equipment Drawing Numbers:
- 2.1.1.1. 09051-440-010-01 HF SSB Sys - Notes, Ref Drawings, Cable & Parts
  - 2.1.1.2. 09051-440-010-02 HF SSB Sys – Block and Connection Diagrams
- 2.1.2. All Phases New Equipment Guidance Drawing:
- 2.1.2.1. 47MLB\_VLE\_E&I\_Drawings\_Prelim.pdf

### 2.2. Standards

- 2.2.1. See General Notes H-1

### 2.3. Regulations

- 2.3.1. See General Notes H-1

### 2.4. Government Supplied Material

- 2.4.1. N/A

### 2.5. Contractor Supplied Material

- 2.5.1. The Contractor must supply everything that is required to perform the specified work unless otherwise stated, such as but not limited to the following: labour, materials, parts, tools, consumables, equipment, machinery, storage, shelters, staging, rigging, scaffolding, enclosures, power and heating.
- 2.5.2. One (1) Icom IC-M802. This equipment includes a MF/HF transceiver, a Control Unit, a Speaker Icom SP-24 and a Microphone Icom HM-135.
- 2.5.3. One (1) Icom AT-140 Antenna Tuning Unit
- 2.5.4. One (1) Shakespeare 390 MF/HFAntenna

- 2.5.5. One (1) Shakespeare 410-R Swivel Mounting Kit for Antenna
- 2.5.6. One (1) Polaris Electronics A159 (62.044) MF/HF DSC Antenna

### **3. PART 3 – TECHNICAL DESCRIPTION**

#### **3.1. General**

- 3.1.1. The Contractor must disconnect and remove the existing MF/HF radiotelephone and all related cabling located in the enclosed bridge along with the antenna tuner and antenna from the open bridge. Equipment and cabling must be protected for reuse.
- 3.1.2. All removed equipment and related cabling must be treated as Class A material and shipped to a location decided upon by the TA. Shipping costs will be via PSPC 1379 action.
- 3.1.3. The Contractor must install the new equipment listed in Section 2 in accordance with OEM instructions and guidance drawings.
- 3.1.4. One (1) Icom IC-M802 MF/HF transceiver must be installed in the enclosed bridge.
- 3.1.5. One (1) speaker must be installed in the enclosed bridge and connected to the MF/HF transceiver.
- 3.1.6. The speaker must be selected to match the impedance and output power requirements of the radio it is connected to.
- 3.1.7. One (1) Antenna tuner to be installed on the vessel exterior at a location agreed to by the technical authority.
- 3.1.8. One (1) MF/HF Antenna to be installed on the vessel exterior at a location agreed to by the technical authority.
- 3.1.9. One (1) DSC Antenna to be installed on the vessel exterior at a location agreed by the technical authority.

#### **3.2. Location**

- 3.2.1. Enclosed bridge and open bridge.

#### **3.3. Interferences**

- 3.3.1. The Contractor is responsible for the identification of all interference items, their temporary removal, secure storage and refitting to the vessel.

### **4. PART 4 – PROOF OF PERFORMANCE**

#### **4.1. Inspection**

- 4.1.1. All work carried out to be verified correct and approved by the Technical Authority by a complete inspection of the MF/HF radio installations.

#### **4.2. Testing**

- 4.2.1. Refer to testing in E100: General Electronics and Informatics – Testing.

4.2.2. The Contractor must demonstrate correct function of each piece of equipment listed in section 2 in accordance with manufacturer's instructions.

**4.3. Certification**

4.3.1. N/A

**5. PART 5 - DELIVERABLES**

**5.1. Drawings/Reports**

5.1.1. The Contractor must produce two (2) electronic PDF copies of a final report for the TA upon completion of the above noted scope of work. The final report must contain the results of all inspections, testing, manufacturer information, part numbers and details of work completed..

5.1.2. The Contractor must include all associated documentation related to this specification as described H-1 General Notes - Section 5 – Documentation and E100 General E&I – Section 5 – Drawings/Reports.

**5.2. Spares**

5.2.1. N/A

**5.3. Training**

5.3.1. N/A

**5.4. Manuals**

5.4.1. The Contractor must include all associated manuals related to this specification as described in H-1 General Notes - Section 7 – Manuals.

	MLB	
Spec Item #: E-125	SPECIFICATION	
Loudhailer/Internal Communications System (Wired)		

## 1. PART 1 – SCOPE

- 1.1. The intent of this specification is to remove the existing loudhailer/internal communications system and replace with new Contractor Supplied Material.
- 1.2. This work must be carried out in Conjunction with the following:
- 1.2.1.1. ~~Error! Reference source not found.E127 General Console Arrangement~~
  - 1.2.1.2. ~~Error! Reference source not found.E128 General Antenna Arrangement~~
  - 1.2.1.3. H12 Refurbish Mast and Buoyancy Tank

## 2. PART 2 – REFERENCES

### 2.1. Guidance Drawings/Nameplate Data

- 2.1.1. Phase I/II/III MLB Existing Equipment Drawing Numbers:
- 2.1.1.1. 47B MLB 440-018-01 Loudhailer System - Notes, Ref Drawings, Parts & Cab
  - 2.1.1.2. 47B MLB 440-018-02 Loudhailer System – Block & Connection Diagrams
- 2.1.2. All Phases New Equipment Guidance Drawing:
- 2.1.2.1. 47MLB\_VLE\_E&I\_Drawings\_Prelim.pdf

### 2.2. Standards

- 2.2.1. See General Notes H-1

### 2.3. Regulations

- 2.3.1. See General Notes H-1

### 2.4. Government Supplied Material

- 2.4.1. N/A

### 2.5. Contractor Supplied Material

- 2.5.1. The Contractor must supply everything that is required to perform the specified work unless otherwise stated, such as but not limited to the following: labour, materials, parts, tools, consumables, equipment, machinery, storage, shelters, staging, rigging, scaffolding, enclosures, power and heating.
- 2.5.2. One (1) Furuno LH-5000 Loudhailer
- 2.5.3. Four (4) Furuno ISP-5000 Intercom Speaker
- 2.5.4. One (1) DNH HP30T Speaker Horn

## 3. PART 3 – TECHNICAL DESCRIPTION

### 3.1. General

- 3.1.1. The Contractor must disconnect and remove the existing loudhailer, talk back speakers and all related cabling located inside the vessel and the talkback speaker horn from the mast. Equipment and cabling must be protected for reuse.
- 3.1.2. All removed equipment and related cabling must be treated as Class A material and shipped to a location decided upon by the TA. Shipping costs will be via PSPC 1379 action.
- 3.1.3. The Contractor must install the new equipment listed in Section 2 in accordance with OEM instructions and guidance drawings.
- 3.1.4. One (1) Furuno LH-5000 must be installed in conjunction with **Error! Reference source not found.**~~E127 General Console Arrangement.~~
- 3.1.5. One (1) DNH HP30T Speaker Horn must be installed in conjunction with **Error! Reference source not found.**~~E128 General Antenna Arrangement.~~
- 3.1.6. One (1) Furuno ISP-5000 Intercom Speaker must be installed in each of the following locations:
  - 3.1.6.1. Forward compartment
  - 3.1.6.2. Survivors space
  - 3.1.6.3. Engine compartment
  - 3.1.6.4. Open Bridge

### 3.2. Location

- 3.2.1. Throughout the vessel.

### 3.3. Interferences

- 3.3.1. The Contractor is responsible for the identification of all interference items, their temporary removal, secure storage and refitting to the vessel.

## 4. PART 4 – PROOF OF PERFORMANCE

### 4.1. Inspection

- 4.1.1. All work carried out to be verified correct and approved by the Technical Authority by a complete inspection of the loudhailer/intercom system installation.

### 4.2. Testing

- 4.2.1. Refer to testing in E100: General Electronics and Informatics – Testing.
- 4.2.2. The Contractor must demonstrate correct function of each piece of equipment listed in section 2 in accordance with manufacturer's instructions.

### 4.3. Certification

- 4.3.1. N/A



## **5. PART 5 - DELIVERABLES**

### **5.1. Drawings/Reports**

- 5.1.1. The Contractor must produce two (2) electronic PDF copies of a final report for the TA upon completion of the above noted scope of work. The final report must contain the results of all inspections, testing, manufacturer information, part numbers and details of work completed..
- 5.1.2. The Contractor must include all associated documentation related to this specification as described H-1 General Notes - Section 5 – Documentation and E100 General E&I – Section 5 – Drawings/Reports.

### **5.2. Spares**

- 5.2.1. N/A

### **5.3. Training**

- 5.3.1. N/A

### **5.4. Manuals**

- 5.4.1. The Contractor must include all associated manuals related to this specification as described in H-1 General Notes - Section 7 – Manuals.

	MLB	
Spec Item #: E-126	SPECIFICATION	
VHF Direction Finder		

## 1. PART 1 – SCOPE

- 1.1. The intent of this specification is to remove the existing VHF direction finder system, and replace with new or existing Government Supplied Material.
- 1.2. This work must be carried out in Conjunction with the following:
- 1.2.1.1. ~~Error! Reference source not found.E116 NMEA Distribution Network~~
  - 1.2.1.2. ~~Error! Reference source not found.E127 General Console Arrangement~~
  - 1.2.1.3. ~~Error! Reference source not found.E128 General Antenna Arrangement~~
  - 1.2.1.4. H12 Refurbish Mast and Buoyancy Tank

## 2. PART 2 – REFERENCES

### 2.1. Guidance Drawings/Nameplate Data

- 2.1.1. Phase I/II/III MLB Existing Equipment Drawing Numbers:
- 2.1.1.1. 47B MLB 440-020-01 VHF-DF Radio Direction Finder - Notes, Ref
  - 2.1.1.2. 47B MLB 440-020-02 VHF-DF Radio Direction Finder – Block diagram
- 2.1.2. New Equipment Drawing:
- 2.1.2.1. Rhotheta antenna mount drawing provided by government
  - 2.1.2.2. 47MLB\_VLE\_E&I\_Drawings\_Prelim.pdf

### 2.2. Standards

- 2.2.1. See General Notes H-1.

### 2.3. Regulations

- 2.3.1. See General Notes H-1

### 2.4. Government Supplied Material

- 2.4.1. One (1) Rhotheta 500M. This equipment includes a RF bearing device antenna unit and the operating device display control unit at a minimum.
- 2.4.2. One (1) Antenna unit mast flange
- 2.4.3. One (1) Antenna gasket

### 2.5. Contractor Supplied Material

- 2.5.1. The Contractor must supply everything that is required to perform the specified work unless otherwise stated, such as but not limited to the following: labour, materials, parts, tools, consumables, equipment, machinery, storage, shelters, staging, rigging, scaffolding, enclosures, power and heating.

- 2.5.2. One (1) Length DF cable – CME Wire Drilmar ABS rated Control Cable 20AWG AU cable
- 2.5.3. One (1) Audio Amplifier 18Watts, 24Vdc, RDL FP-PA18
- 2.5.4. One (1) Exciter Type Speaker 4ohm 105dB 20W, PUI Audio ASX10104-SPD-R
- 2.5.5. One (1) Ferrite Core 93ohms, Wurth Elektronik 74271308
- 2.5.6. One (1) Audio Transformer 1:1 4W, Hammond 117F4

### 3. PART 3 – TECHNICAL DESCRIPTION

#### 3.1. General

- 3.1.1. The existing VHF Direction Finder control unit, antenna and all related cabling located in the enclosed bridge console and on the mast must be removed from the vessel. Equipment and cabling must be protected for reuse.
- 3.1.2. In the case where a vessel is already fitted with the Rhotheta RT-500-M, the contractor shall remove, retain and reinstall the material in conjunction with E127 General Console Arrangement and E128 General Antenna Arrangement.
- 3.1.3. All removed equipment and related cabling are to be treated as Class A material and shipped to a location decided upon by the TA. Shipping costs will be via PSPC 1379 action.
- 3.1.4. The Contractor must install the new equipment listed in Section 2 in accordance with OEM instructions and guidance drawings.
- 3.1.5. The Contractor to install Rhotheta 500M antenna unit and mast flange at the same height as the existing DF antenna in conjunction with **Error! Reference source not found.**~~E128-General Antenna Arrangement.~~
- 3.1.6. One (1) Rhotheta 500M operating device display control unit must be interfaced and installed in conjunction with **Error! Reference source not found.**~~E116-NMEA Distribution Network~~ and **Error! Reference source not found.**~~E127-General Console Arrangement.~~
- 3.1.7. One (1) External speaker must be interfaced and installed in the enclosed bridge
- 3.1.8. The contractor must supply an aluminum mounting plate and install and interface the following components on it:
  - Ferrite Core
  - Audio Transformer 1:1
  - Audio Amplifier
- 3.1.9. The contractor must interface the components on the mounting plate in accordance with the table below using Deutsche connectors:

Deutsche Connectors Wiring (DF System Mating Side)			
	Pin Number	Cable Color	Function
CDU Speaker Out (+/-)	1	Red	<u>CDU Speaker + out</u>
	2	Black	<u>CDU Speaker - out</u>
External Speaker	3	Red	ASX10104-SPD-R (+)
	4	Black	ASX10104-SPD-R (-)
Power Connector	5	Red	+24 VDC to DIN
	6	Black	Negative Power terminal

Deutsche Connectors Wiring (Amplifier/ Filter Mating Side)			
	Pin Number	Cable Color	Function
Speaker input	1	Red	<u>Transformer Audio input +</u>
	2	Black	<u>Transformer Audio input -</u>
External Speaker	3	Red	Amplifier 8 ohm out +
	4	Black	Amplifier 8 ohm out -
Power Connector	5	Red	+24 VDC to Amplifier
	6	Black	Negative Power terminal

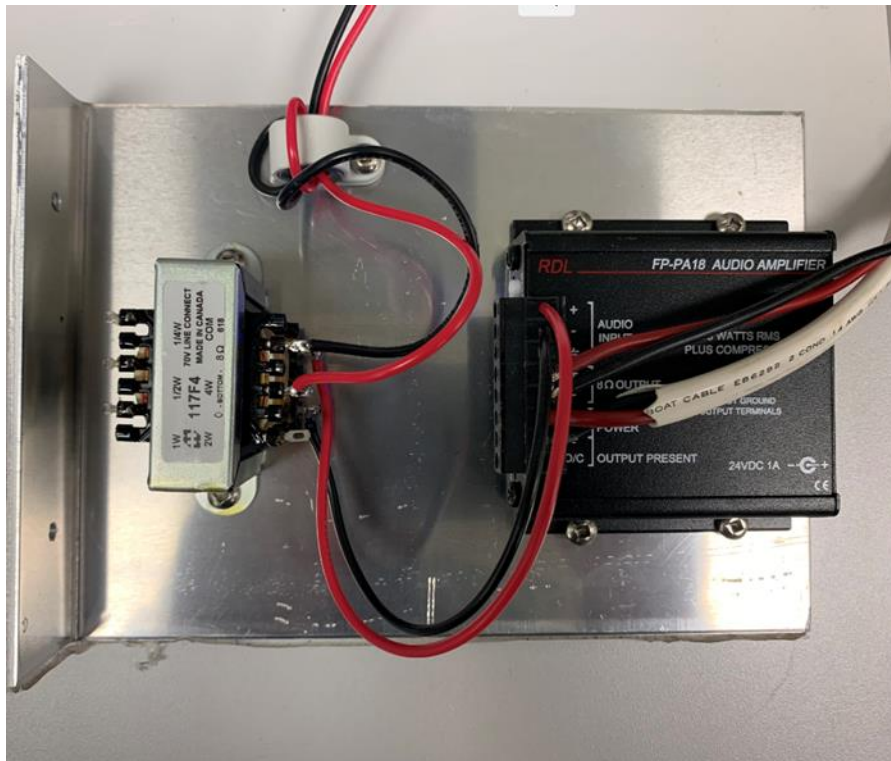

### 3.2. Location

3.2.1. Enclosed bridge and Mast

### 3.3. Interferences

- 3.3.1. The Contractor is responsible for the identification of all interference items, their temporary removal, secure storage and refitting to the vessel.

#### **4. PART 4 – PROOF OF PERFORMANCE**

##### **4.1. Inspection**

- 4.1.1. All work carried out to be verified correct and approved by the Technical Authority by a complete inspection of the VHF DF with emphasis on ensuring that the antenna direction is lined up with the bow of the vessel.

##### **4.2. Testing**

- 4.2.1. Refer to testing in E100: General Electronics and Informatics – Testing.
- 4.2.2. The Contractor must demonstrate correct function of each piece of equipment listed in section 2 in accordance with manufacturer's instructions.
- 4.2.3. The Contractor must demonstrate correct function of the Rhotheta 500M operating device display control unit in conjunction with E116 NMEA Distribution Network.

##### **4.3. Certification**

- 4.3.1. N/A

#### **5. PART 5 – DELIVERABLES**

##### **5.1. Drawings/Reports**

- 5.1.1. The Contractor must produce two (2) electronic PDF copies of a final report for the TA upon completion of the above noted scope of work. The final report must contain the results of all inspections, testing, manufacturer information, part numbers and details of work completed..
- 5.1.2. The Contractor must include all associated documentation related to this specification as described H-1 General Notes - Section 5 – Documentation and E100 General E&I – Section 5 – Drawings/Reports..

##### **5.2. Spares**

- 5.2.1. N/A

##### **5.3. Training**

- 5.3.1. N/A

##### **5.4. Manuals**

- 5.4.1. The Contractor must include all associated manuals related to this specification as described in H-1 General Notes - Section 7 – Manuals.

	MLB	
Spec Item #: E-127	SPECIFICATION	
General Console Arrangement		

## 1. PART 1 - SCOPE

- 1.1.** The intent of this specification is to install new displays and equipment in the existing enclosed bridge and open bridge consoles, making console modifications and adapter plates as required.
- 1.2.** This work must be carried out in Conjunction with the following:
- 1.2.1.1. E-113 Electronic Charting System Displays
  - 1.2.1.2. E-115 Navigation Instrument Displays
  - 1.2.1.3. E-118 Combined Differential Global Navigation Satellite System and Automatic Identification System (DGNSS/AIS)
  - 1.2.1.4. E-121 Autopilot
  - 1.2.1.5. E-123 VHF Radio(s)
  - 1.2.1.6. E-125 Loudhailer/Internal Communication System
  - 1.2.1.7. E-126 VHF DF

## 2. PART 2 – REFERENCES

### 2.1. Guidance Drawings/Nameplate Data

- 2.1.1. Phase III MLB Existing Equipment Drawing Numbers:
- 2.1.1.1. 47B MLB 438-010-01 Console Arrange - Notes, Ref Drawings & Overview
  - 2.1.1.2. 47B MLB 438-010-02 Console Arrange – Equipt List Encl Bridge
  - 2.1.1.3. 47B MLB 438-010-03 Console Arrange – Equipt Layout Encl Bridge
  - 2.1.1.4. 47B MLB 438-010-04 Console Arrange - Equipt List & Layout Open Bridge
  - 2.1.1.5. 47B MLB 438-010-05 Console Arrange - Equipt List & Layout Open Bridge
  - 2.1.1.6. 47B MLB 438-010-06 Console Arrange - Equipt List & Layout Open Bridge
- 2.1.2. All Phases New Equipment Guidance Drawing:
- 2.1.2.1. 47MLB\_VLE\_E&I\_Drawings\_Prelim.pdf

### 2.2. Standards

- 2.2.1. N/A

**2.3. Regulations**

2.3.1. N/A

**2.4. Government Supplied Material**

2.4.1. N/A

**2.5. Contractor Supplied Material**

2.5.1. The Contractor must supply everything that is required to perform the specified work unless otherwise stated, such as but not limited to the following: labour, materials, parts, tools, consumables, equipment, machinery, storage, shelters, staging, rigging, scaffolding, enclosures, power and heating.

**3. PART 3 – TECHNICAL DESCRIPTION****3.1. General**

- 3.1.1. The Contractor is responsible for the removal of all existing displays, transceivers, associated wiring, junction boxes etc. from the consoles of the vessel as described in sections listed in 1.2.
- 3.1.2. The contractor must retain and reinstall the existing air to ground radio, loudhailer and magnetic compass located in the enclosed bridge console in accordance with the new console arrangement drawings.
- 3.1.3. The Contractor must retain and reinstall the the existing magnetic compass on the open bridge.
- 3.1.4. The Contractor must ensure equipment enclosures provide for the manufacturer's recommended cooling and air circulation rates.
- 3.1.5. The Contractor must mount equipment in the open bridge and enclosed bridge consoles using the new console arrangement drawings as a guide.
- 3.1.6. The Contractor must install the new equipment listed in 1.2 in accordance with OEM instructions.
- 3.1.7. The Contractor must install all equipment in a flush mount or surface mount configuration allowing only the minimum equipment profile to protrude from the console face as the equipment manufacturer designed.
- 3.1.8. The Contractor must design and install technical authority-approved equipment mounts or brackets where manufacturer supplied mounting causes interference with adjacent equipment or does not exist.
- 3.1.9. The Contractor must ensure all equipment is mounted to the console allowing maintainers to remove equipment in under 30 minutes.
- 3.1.10. The Contractor must produce to-scale, computer-generated drawings of the proposed console layout for approval by the Technical Authority, prior to the fabrication of any pieces.
- 3.1.11. **Location**

3.1.12. Enclosed bridge and open bridge

**3.2. Interferences**

3.2.1. The Contractor is responsible for identifying all interference items, their removal, storage and subsequent installation upon approval of the Technical Authority.

**4. PART 4 – PROOF OF PERFORMANCE**

**4.1. Inspection**

4.1.1. All work carried out to be verified correct and approved by the Technical Authority by complete inspection of all installed equipment.

**4.2. Testing**

4.2.1. N/A

**4.3. Certification**

4.3.1. N/A

**5. PART 5 - DELIVERABLES**

**5.1. Drawings/Reports**

5.1.1. The Contractor must produce two (2) electronic PDF copies of a final report for the TA upon completion of the above noted scope of work. The final report must contain the results of all inspections, testing, manufacturer information, part numbers and details of work completed..

5.1.2. The Contractor must include all associated documentation related to this specification as described H-1 General Notes - Section 5 – Documentation and E100 General E&I – Section 5 – Drawings/Reports.

**5.2. Spares**

5.2.1. N/A

**5.3. Training**

5.3.1. N/A

**5.4. Manuals**

5.4.1. The Contractor must include all associated manuals related to this specification as described in H-1 General Notes - Section 7 – Manuals.



	MLB	
Spec Item #: E-128	SPECIFICATION	
General Antenna Arrangement		

## 1. PART 1 – SCOPE

- 1.1. The intent of this specification is to remove all existing antennas, speakers, etc. from the exterior of the vessel and then install new antennas, speakers, etc. on the vessel exterior.
- 1.2. This work must be carried out in Conjunction with the following:
- 1.2.1.1. ~~Error! Reference source not found.E112 Open Array Radar~~
  - 1.2.1.2. ~~Error! Reference source not found.E117 Satellite Compass~~
  - 1.2.1.3. ~~Error! Reference source not found.E118 DGNSS/AIS~~
  - 1.2.1.4. ~~Error! Reference source not found.E122 Integrated Communications System (Wireless)~~
  - 1.2.1.5. ~~Error! Reference source not found.E123 VHF Radio(s)~~
  - 1.2.1.6. ~~Error! Reference source not found.E124 MF/HF Radio~~
  - 1.2.1.7. ~~Error! Reference source not found.E125 Loudhailer/Internal Communications System~~
  - 1.2.1.8. ~~Error! Reference source not found.E126 VHF DF~~
  - 1.2.1.9. ~~Error! Reference source not found.E129 Weather Station Instrument~~
  - 1.2.1.10. ~~Error! Reference source not found.E130 Cellular Repeater~~
  - 1.2.1.11. ~~Error! Reference source not found.E131 Navtex~~
  - 1.2.1.12. H12 Refurbish Mast and Buoyancy Tank

## 2. PART 2 – REFERENCES

### 2.1. Guidance Drawings/Nameplate Data

- 2.1.1. Phase III MLB Existing Equipment Drawing Numbers:
- 2.1.1.1. 47B MLB 405-010-01 Antenna Arrange & Install - Notes, Ref Drawings
  - 2.1.1.2. 47B MLB 405-010-02 Antenna Arrange & Install - Antenna Arrangement
  - 2.1.1.3. 47B MLB 405-010-03 Antenna Arrange & Install - Installation Details
  - 2.1.1.4. 47B MLB 405-010-04 Antenna Arrange & Install - Installation Details
  - 2.1.1.5. 47B MLB 405-010-05 Antenna Arrange & Install - Installation Details
- 2.1.2. All Phases New Equipment Guidance Drawing:
- 2.1.2.1. 47MLB\_VLE\_E&I\_Drawings\_Prelim.pdf

### 2.2. Standards

2.2.1. See General Notes H-1

**2.3. Regulations**

2.3.1. See General Notes H-1

**2.4. Government Supplied Material**

2.4.1. N/A

**2.5. Contractor Supplied Material**

2.5.1. The Contractor must supply everything that is required to perform the specified work unless otherwise stated, such as but not limited to the following: labour, materials, parts, tools, consumables, equipment, machinery, storage, shelters, staging, rigging, scaffolding, enclosures, power and heating.

**3. PART 3 – TECHNICAL DESCRIPTION**

**3.1. General**

3.1.1. The Contractor is responsible for the removal of all existing antennae, associated wiring, junction boxes, speakers etc. from the exterior of the vessel as described in sections listed in 1.2.

3.1.2. The contractor must retain and reinstall the two loudhailer speakers, Iridium satellite phone antenna and the VHF AM air to ground radio antenna on the mast.

3.1.3. The Contractor must install a new coaxial cable for the existing VHF AM air to ground radio antenna.

3.1.4. The Contractor must install a new coaxial cable for the existing Iridium satellite phone antenna.

3.1.5. The Contractor must install new cabling for the two existing loudhailer speakers.

3.1.6. The Contractor must create a General Arrangement plan that meets all the OEM's installation guidelines and present the plan to the TA.

3.1.7. The location of antennae is critical. The Contractor must install the antennae and wiring in accordance with OEM guidelines while applying the following rules:

3.1.7.1. The maximum possible separation must be provided between the transmitting and receiving antennae. For this purpose, the radiotelephone antenna must be classed as a Transmitting Antenna;

3.1.7.2. The siting of antennae must be such that the deck area surrounding the antennae is as clear of metallic obstruction as is practical;

3.1.7.3. Wherever possible, metallic material located close by an antenna should be replaced by a non-metallic equivalent;

3.1.7.4. Radio antennae must be given all of the height that is practical, but maximum height must be provided in this order, for:

- 3.1.7.4.1. VHF Direction Finder;
- 3.1.7.4.2. Cellular repeater;
- 3.1.7.4.3. VHF-FM Radiotelephones; and,
- 3.1.7.4.4. Existing VHF AM Radiotelephone.

3.1.7.5. Satellite antennae must be given all the clearance that is practical, but maximum unobstructed view of the sky must be provided in this order, for:

- 3.1.7.5.1. ~~Error! Reference source not found.E118-DGNSS/AIS~~
- 3.1.7.5.2. ~~Error! Reference source not found.Error! Reference source not found.E117-Satellite Compass~~
- 3.1.7.5.3. ~~Error! Reference source not found.E131-Weather Station Instrument~~
- 3.1.7.5.4. Existing Iridium Antenna

3.1.8. The location of the radar antenna must take into account the shadowing effects of upper deck obstructions. The chosen location must minimise the effect of any shadow and/or blind arc created;

3.1.9. The contractor shall contract a specialized individual to develop a report that evaluates the antennae arrangement, defines an analysis process, and identifies and quantifies electromagnetic interference problems as well as radiation hazards to personnel and fuel that have the potential to compromise safety and/or mission effectiveness of the lifeboat. The selected evaluation criteria must be based on commercial marine and relevant military standards and guidelines.

3.1.10. The report must highlight most likely electromagnetic radiation hazards and interference cases and, where possible, quantify findings. Recommendations and suggested corrective actions must also be included. Any assumptions that can influence results of the analysis must be recorded, thus providing verifiable baselines for recommendations and suggested corrective actions.

3.1.11. The final antenna siting must be approved by the Technical Authority prior to commencement of installation. The Technical Authority is presently satisfied with the layout on the existing phase III MLB vessels but newly-installed antennas must pass performance checks.

## **3.2. Location**

3.2.1. Vessel exterior

## **3.3. Interferences**

- 3.3.1. The Contractor is responsible for the identification of all interference items, their temporary removal, storage and refitting to the vessel.

#### **4. PART 4 – PROOF OF PERFORMANCE**

##### **4.1. Inspection**

- 4.1.1. All work carried out to be verified correct and approved by the Technical Authority.

##### **4.2. Testing**

- 4.2.1. Refer to testing in E100: General Electronics and Informatics – Testing.
- 4.2.2. The contractor must demonstrate correct function of all equipment in accordance with manufacturer’s specifications without interference.

##### **4.3. Certification**

- 4.3.1. N/A

#### **5. PART 5 - DELIVERABLES**

##### **5.1. Drawings/Reports**

- 5.1.1. The Contractor must produce two (2) electronic PDF copies of a final report for the TA upon completion of the above noted scope of work. The final report must contain the results of all inspections, testing, manufacturer information, part numbers and details of work completed..
- 5.1.2. The Contractor must include all associated documentation related to this specification as described H-1 General Notes - Section 5 – Documentation and E100 General E&I – Section 5 – Drawings/Reports.

##### **5.2. Spares**

- 5.2.1. N/A

##### **5.3. Training**

- 5.3.1. N/A

##### **5.4. Manuals**

- 5.4.1. The Contractor must include all associated manuals related to this specification as described in H-1 General Notes - Section 7 – Manuals.

	MLB	
Spec Item #: E-129	SPECIFICATION	
Weather Station Instrument		

## 1. PART 1 - SCOPE

- 1.1. The intent of this specification is to remove the existing weather station instrument and replace with new Contractor Supplied Material.
- 1.2. This work must be carried out in Conjunction with the following:
- 1.2.1.1. ~~Error! Reference source not found.E116 NMEA Distribution Network~~
  - 1.2.1.2. ~~Error! Reference source not found.E128 General Antenna Arrangement~~
  - 1.2.1.3. H12 Refurbish Mast and Buoyancy Tank

## 2. PART 2 – REFERENCES

### 2.1. Guidance Drawings/Nameplate Data

- 2.1.1. All Phases New Equipment Guidance Drawing:
- 2.1.1.1. 47MLB\_VLE\_E&I\_Drawings\_Prelim.pdf

### 2.2. Standards

- 2.2.1. N/A

### 2.3. Regulations

- 2.3.1. N/A

### 2.4. Government Supplied Material

- 2.4.1. N/A

### 2.5. Contractor Supplied Material

- 2.5.1. The Contractor must supply everything that is required to perform the specified work unless otherwise stated, such as but not limited to the following: labour, materials, parts, tools, consumables, equipment, machinery, storage, shelters, staging, rigging, scaffolding, enclosures, power and heating.
- 2.5.1.1. One (1) Airmar 220WX Weather Station Instrument

## 3. PART 3 – TECHNICAL DESCRIPTION

### 3.1. General

- 3.1.1. The existing weather station instrument may not be installed on all vessels. The contractor must disconnect and remove an existing weather station instrument, display and any related cabling from throughout the vessel. Equipment and cabling must be protected for reuse.

- 3.1.2. All removed equipment and related cabling must be treated as Class A material and shipped to a location decided upon by the TA. Shipping costs will be via PSPC 1379 action.
- 3.1.3. The Contractor must install the new equipment listed in Section 2 in accordance with OEM instructions and guidance drawings.
- 3.1.4. One (1) Airmar 220WX must be interfaced and installed on the mast in conjunction with Error! Reference source not found.E116 NMEA Distribution Network and Error! Reference source not found.E127 General Antenna Arrangement.

### **3.2. Location**

- 3.2.1. Mast

### **3.3. Interferences**

- 3.3.1. The Contractor is responsible for identifying all interference items, their removal, storage and subsequent installation upon approval of the Technical Authority.

## **4. PART 4 – PROOF OF PERFORMANCE**

### **4.1. Inspection**

- 4.1.1. All work carried out to be verified correct and approved by the Technical Authority by a complete inspection of the weather station instrument.

### **4.2. Testing**

- 4.2.1. Refer to testing in E100: General Electronics and Informatics – Testing.
- 4.2.2. The Contractor must demonstrate correct function of each piece of equipment listed in section 2 in accordance with manufacturer's instructions.
- 4.2.3. The Contractor must demonstrate correct function of the weather station instrument in conjunction with Error! Reference source not found.E116 NMEA Distribution Network.

### **4.3. Certification**

- 4.3.1. N/A

## **5. PART 5 – DELIVERABLES**

### **5.1. Drawings/Reports**

- 5.1.1. The Contractor must produce two (2) electronic PDF copies of a final report for the TA upon completion of the above noted scope of work. The final report must contain the results of all inspections, testing, manufacturer information, part numbers and details of work completed..

5.1.2. The Contractor must include all associated documentation related to this specification as described H-1 General Notes - Section 5 - Documentation and E100 General E&I – Section 5 – Drawings/Reports.

**5.2. Spares**

5.2.1. N/A

**5.3. Training**

5.3.1. N/A

**5.4. Manuals**

5.4.1. The Contractor must include all associated manuals related to this specification as described in H-1 General Notes - Section 7 – Manuals.

	MLB	
Spec Item #: E-130	SPECIFICATION	
Cellular Repeater		

## 1. PART 1 - SCOPE

- 1.1. The intent of this specification is to remove the existing cellular repeater and replace with new Contractor Supplied Material.
- 1.2. This work must be carried out in Conjunction with the following:
- 1.2.1. **Error! Reference source not found.**~~E128 General Antenna Arrangement~~
- 1.2.2. H12 Refurbish Mast and Buoyancy Tank

## 2. PART 2 – REFERENCES

### 2.1. Guidance Drawings/Nameplate Data

- 2.1.1. Phase III MLB Existing Equipment Drawing Numbers:
- 2.1.1.1.1. 47B MLB 440-016-01 Cellular Sys - Notes, Ref Drawings, Cable & Parts
- 2.1.1.1.2. 47B MLB 440-016-02 Cellular Sys - Block & Connection Diagrams
- 2.1.2. All Phases New Equipment Guidance Drawing:
- 2.1.2.1. 47MLB\_VLE\_E&I\_Drawings\_Prelim.pdf

### 2.2. Standards

- 2.2.1. N/A

### 2.3. Regulations

- 2.3.1. N/A

### 2.4. Government Supplied Material

- 2.4.1. N/A

### 2.5. Contractor Supplied Material

- 2.5.1. The Contractor must supply everything that is required to perform the specified work unless otherwise stated, such as but not limited to the following: labour, materials, parts, tools, consumables, equipment, machinery, storage, shelters, staging, rigging, scaffolding, enclosures, power and heating.
- 2.5.1.1. One (1) Smoothtalker Stealth X6 cellular booster, Part Number BBCX665gaa
- 2.5.1.2. One (1) Smoothtalker panel antenna, Part Number SEMDP1NL
- 2.5.1.3. One (1) Surecall SC-288 external antenna
- 2.5.1.4. One (1) AC adapter



2.5.1.5. LMR-400 cabling and connectors for RF transmission lines.

### **3. PART 3 – TECHNICAL DESCRIPTION**

#### **3.1. General**

- 3.1.1. The existing cellular repeater instrument may not be installed on all vessels. The contractor must disconnect and remove an existing cellular repeater, antennas and any related cabling from throughout the vessel.
- 3.1.2. The Contractor must install the new equipment listed in Section 2 in accordance with OEM instructions and guidance drawings.
- 3.1.3. Smoothtalker Stealth X6 BBCX665gaa and SEMDP1NL panel antenna must be installed in the enclosed bridge.
- 3.1.4. Surecall SC-288 antenna must be installed in conjunction with **Error! Reference source not found.**~~E128 General Antenna Arrangement.~~

#### **3.2. Location**

- 3.2.1. Enclosed bridge and mast

#### **3.3. Interferences**

- 3.3.1. The Contractor is responsible for identifying all interference items, their removal, storage and subsequent installation upon approval of the Technical Authority.

### **4. PART 4 – PROOF OF PERFORMANCE**

#### **4.1. Inspection**

- 4.1.1. All work carried out to be verified correct and approved by the Technical Authority by a complete inspection of the cellular repeater installation..

#### **4.2. Testing**

- 4.2.1. Refer to testing in E100: General Electronics and Informatics – Testing.
- 4.2.2. The Contractor must demonstrate correct function of each piece of equipment listed in section 2 in accordance with manufacturer's instructions.

#### **4.3. Certification**

- 4.3.1. N/A

### **5. PART 5 - DELIVERABLES**

#### **5.1. Drawings/Reports**

- 5.1.1. The Contractor must produce two (2) electronic PDF copies of a final report for the TA upon completion of the above noted scope of work. The final report must contain the results of all inspections, testing, manufacturer information, part numbers and details of work completed..

5.1.2. The Contractor must include all associated documentation related to this specification as described H-1 General Notes - Section 5 - Documentation and E100 General E&I – Section 5 – Drawings/Reports.

**5.2. Spares**

5.2.1. N/A

**5.3. Training**

5.3.1. N/A

**5.4. Manuals**

5.4.1. The Contractor must include all associated manuals related to this specification as described in H-1 General Notes - Section 7 – Manuals.

	MLB	
Spec Item #: E-131	SPECIFICATION	
Navtex		

## 1. PART 1 - SCOPE

- 1.1. The intent of this specification is to remove the existing Navtex receiver and replace with new Contractor Supplier Material.
- 1.2. This work must be carried out in Conjunction with the following:
- 1.2.1. **Error! Reference source not found.**~~E128 General Antenna Arrangement~~
- 1.2.2. H12 Refurbish Mast and Buoyancy Tank

## 2. PART 2 – REFERENCES

### 2.1. Guidance Drawings/Nameplate Data

- 2.1.1. Phase I/III MLB Drawings:
- 2.1.1.1. 47B MLB 426-018-01 Navtex Receiver - Notes, Ref Drawings, Parts
- 2.1.1.2. 47B MLB 426-018-02 Navtex Receiver - Cable & Connection Diagram
- 2.1.2. All Phases New Equipment Guidance Drawing:
- 2.1.2.1. 47MLB\_VLE\_E&I\_Drawings\_Prelim.pdf

### 2.2. Standards

- 2.2.1. N/A

### 2.3. Regulations

- 2.3.1. N/A

### 2.4. Government Supplied Material

- 2.4.1. N/A

### 2.5. Contractor Supplied Material

- 2.5.1. The Contractor must supply everything that is required to perform the specified work unless otherwise stated, such as but not limited to the following: labour, materials, parts, tools, consumables, equipment, machinery, storage, shelters, staging, rigging, scaffolding, enclosures, power and heating.
- 2.5.1.1. One (1) Furuno NX-700B Display
- 2.5.1.2. One (1) Furuno NX-7001 Receiver Unit
- 2.5.1.3. One (1) Furuno NX-7H Antenna Unit

## 3. PART 3 – TECHNICAL DESCRIPTION

### 3.1. General

- 3.1.1. The existing Navtex receiver may not be installed on all vessels. The contractor must disconnect and remove an existing Navtex receiver, antennas and any related cabling from throughout the vessel.
- 3.1.2. The Contractor must install the new equipment listed in Section 2 in accordance with OEM instructions and guidance drawings.
- 3.1.3. Furuno NX-700B display and NX-70001 receiver unit must be installed in the survivors compartment.
- 3.1.4. Furuno NX-7H antenna must be installed in conjunction with **Error! Reference source not found.**~~E128 General Antenna Arrangement.~~

### **3.2. Location**

- 3.2.1. Survivor's compartment and mast

### **3.3. Interferences**

- 3.3.1. Contractor is responsible for identifying all interference items, their removal, storage and subsequent installation upon approval of the Technical Authority.

## **4. PART 4 – PROOF OF PERFORMANCE**

### **4.1. Inspection**

- 4.1.1. All work carried out to be verified correct by the Technical Authority by a complete inspection of the Navtex installation.

### **4.2. Testing**

- 4.2.1. Refer to testing in E100: General Electronics and Informatics – Testing.
- 4.2.2. The Contractor must demonstrate correct function of each piece of equipment listed in section 2 in accordance with manufacturer's instructions.

### **4.3. Certification**

- 4.3.1. N/A

## **5. PART 5 - DELIVERABLES**

### **5.1. Drawings/Reports**

- 5.1.1. The Contractor must produce two (2) electronic PDF copies of a final report for the TA upon completion of the above noted scope of work. The final report must contain the results of all inspections, testing, manufacturer information, part numbers and details of work completed..
- 5.1.2. The Contractor must include all associated documentation related to this specification as described H-1 General Notes - Section 5 - Documentation and E100 General E&I – Section 5 – Drawings/Reports.

### **5.2. Spares**

5.2.1. N/A

**5.3. Training**

5.3.1. N/A

**5.4. Manuals**

5.4.1. The Contractor must include all associated manuals related to this specification as described in H-1 General Notes - Section 7 – Manuals.

## **Annex A**

## **1.0 Scope**

### **1.1 Title**

47’ MLB inclining experiment and lightship survey.

### **1.2 Introduction**

Inclining experiments and lightship surveys are required for the 47’ MLBs. The first MLB to undergo Vessel Life Extension (VLE) in each geographical area will have an inclining experiment completed. The Contractor shall obtain permission from ABS to conduct a lightship check only on subsequent VLEs.

A number of modifications have been made to the 47’ MLBs since they were commissioned. The cumulative effect of these modifications warrant an inclining experiment to establish the new stability baseline with greater accuracy.

### **1.3 Objectives**

The objective is to receive final lightship and incline experiment reports endorsed by an ABS Class Surveyor.

## **2.0 Roles and Responsibilities**

The inclining experiment and lightship surveys will be carried out by the contractor’s Naval Architect. The inclining experiment procedure and results must be reviewed and approved by an ABS surveyor. The inclining experiment must be witnessed by an ABS Surveyor and CCG representative. The tank soundings will be carried out by the contractor’s personnel and witnessed by all parties. Below are detailed description of the roles and responsibilities of those in attendance.

### **2.1 The Contractor’s Naval Architect**

The Contractor’s Naval Architect will be responsible for:

- determining the size of the inclining weights required for the inclining experiment;
- sourcing the inclining weights;
- sourcing & supplying a certified dynamometer used for the inclining weights’ certification;
- certification of the weights using the certified dynamometer (with assistance from

Annex A –  
Statement of Work – 47’ MLB Inclining and Lightship Survey

---

- crane operator and/or contractor’s personnel for moving and lifting weights);
- making appropriate arrangements to ensure that the inclining weights are delivered onsite prior to the inclining experiment;
- marking the proper position for the weights on the ship.
- Use the provided compartment survey sheets and recording weights and vertical and longitudinal centres of items to be removed, added, or relocated.

## **2.2 The Contractor**

The Contractor will be responsible for:

- Providing appropriate lifting equipment (boom truck, crane, etc.) for certification of weights and moving them to the proper location onboard;
- Ensuring that no one be permitted to be onboard the vessel during the test.
- Ensuring the storage tanks are ideally dry or pressed full (100%). Note that dry tanks are preferred. Vessel has one (1) fuel tank and one (1) bilge water storage tank.
- Removal of any manholes accessing empty tanks, void spaces, and tanks where soundings are suspect of not showing all contents for inspection.
- Ensuring empty tanks are pumped dry. If there is a substantial amount of “unpumpables”, the content should be removed by other means.
- Ensure system tanks are at their operating levels.
- Ensuring all tank sounding pipe covers are free for removal and the pipes clear for sounding. Note: In case this cannot be achieved the tank shall be emptied and opened up for inspection.
- Ensuring all spaces onboard are unlocked and accessible.
- Ensuring all movable equipment is in its stowed positions.
- Ensuring decks are free of standing water, snow etc.
- Ensuring the initial list of the vessel is less than 0.5 degrees.
- Ensuring the trim of the vessel is less than half percent of LBP, unless trimmed hydrostatics and tank calibrations are available, in which case the trim has to be within the range covered by the tables.
- Provide a boat to take the draft marks readings.

## **2.3 CCG Project Authority/CCG Technical Authority ( CCG TA)**

The CCG Project Authority/CCG Technical Authority will be responsible for:

- providing copies of the latest Stability Book, including hydrostatics, tank plan and tank calibration tables, GHS model, Draft Mark Drawing, and a General Arrangement Plan to be used for recording weights "on and off";
- Ensuring that the number of items to be added, removed or relocated from the



Annex A –  
Statement of Work – 47’ MLB Inclining and Lightship Survey

---

- normal operating condition shall be kept to a minimum.
- witnessing the entirety of the inclining experiment

#### **2.4 ABS Surveyor**

The ABS Surveyor will be responsible for:

- witnessing the entirety of the inclining experiment and endorse the final report.

Note: Prior to the Inclining Experiment Contractor must submit the Inclining Experiment Procedure to ABS for review and approval at least two weeks prior to the inclining experiment.

Note: If the heel and trim of the ship is excessive, the heel or trim should be corrected by use of levelling weights. If the use of levelling weights is found to be impracticable, liquid can be inserted into selected tanks to achieve the desired correction. If liquids are used, the numbers of slack tanks should be kept at a minimum. Tanks that are slack should preferably be between 40% and 80% full.

### **3.0 Requirements**

#### **3.1 CCG Supplied Equipment**

The CCG is responsible for supplying the following equipment:

- NIL

#### **3.2 Contractor Supplied Equipment**

The Contractor is responsible for supplying the following equipment:

- Tank sounding tape;
- Paste for sounding fresh water and water ballast tanks;
- Chalk or "powder cleanser" for sounding fuel oil tanks;
- Flash light for inspection of tanks;
- Boat for reading draft marks;
- Rope and a bucket for taking water sample, specific gravity;
- Portable VHF Radios.
- Hydrometer to measure the density of the sea water sample;
- Tape measure for determining the location of misc. equipment;
- Writing material and note books for recording the survey data;

## Annex A – Statement of Work – 47’ MLB Inclining and Lightship Survey

---

- Plumb bob or suitable item for taking ullage measurements (if necessary);
- Two pendulums, recording boards, clamps, oil troughs and oil/soap;
- Tape measure (metric and/or imperial);
- Draft reading kit;
- Marker/chalk for outlining inclining weight locations;
- Coordinating the crane and operator for movement of inclining weights.

### **3.3 Environmental Conditions**

If excessive wind, wave height, or current are prohibitive of getting accurate pendulum and draft mark readings, the experiment will be postponed or cancelled, until all responsible parties agree that the readings can be made sufficiently accurate.

### **3.4 Preparation for Inclining and Deadweight Survey**

All fuel and fresh water storage tanks should be either at their full operating level or empty. If the tanks cannot be fully determined as being empty, the manhole covers shall be removed and tanks inspected, so that it can be verified that the tanks are indeed empty.

All items listed under Contractor’s roles and responsibilities will be verified by the Contractor’s Naval Architect and ABS Surveyor to be correct and acceptable.

While determining and verifying the trim, heel and drafts of the vessel, the Contractor’s Naval Architect will insure that any abrupt changes in the hull form do not become immersed during the inclining experiment.

Two pendulums will be hung by the Contractor’s Naval Architect, one at each end of the vessel. Each pendulum will be of appropriate length to obtain a suitable deflection, and to minimize error. Prescribed pendulum deflection is the drive to determine either the pendulum length or the inclining weight moment. Pendulums will be located in an area protected from wind and weather. Pendulum weights will be suspended in oil or liquid soap to dampen excessive movement.

The Contractor and Naval Architect should reference “20-05-28 - Inclining Experiment Procedure[EN].pdf” for further guidance material attached in appendix A.

### **3.5 Deadweight Survey**

Prior to the inclining experiment, the Contractor must conduct a deadweight survey of all

## Annex A – Statement of Work – 47’ MLB Inclining and Lightship Survey

---

compartments on the vessel being inclined. Items considered part of lightship will be recorded. Items that cannot be removed from the vessel and lifesaving equipment are considered to be part of lightship. All other items are considered to be deadweight items must be recorded as items to be removed from lightship. All measured weights and Center of Gravity (CoGs) must be recorded in the compartment survey sheets. The Naval Architect must classify the weights within weight groups e.g. ‘Consumables’, ‘General Stores’, ‘Crew and Effects’, ‘Spare Parts’, ‘Tools’, etc. The Naval Architect can develop the weight groups, however they must resemble typical weight groups in the stability book. The intention of the weights classification within the weight groups is to have a breakdown of non-lightship items.

The Contractor must use the Compartment Survey sheet for each compartment survey as outlined in Annex A, Section C and fully developed in the document “MLB\_Weight\_Tracking\_Annex\_EN.XLSX”.

Tank soundings will be taken by the Contractor’s personnel and witnessed by the Naval Architect and the ABS Surveyor.

Weight and vertical and longitudinal centres of items to be removed, added, or relocated will be recorded by the Naval Architect in the compartment survey sheets.

The contractor must provide the summary table of all surveyed weight that are recorded using the compartment survey sheets.

### **3.6 Inclining Experiment**

As stated in the sub-section 2.4, prior to the Inclining Experiment the Contractor must submit approved Inclining Experiment Procedure to ABS. Inclining experiment must be conducted using the following standard: *IMO 2008 Intact Stability Code*.

The CCG supplied “*Inclining Experiment and Lightship Survey Checklist*” in Annex A Section C must be filled out by the Naval Architect.

The CCG supplied “*Report of an Inclining Experiment and Lightship Survey*” in Annex A Section D must be filled out by the Naval Architect.

Contractor will make note of the representatives of attending parties and the number and locations of personnel on board.

Weather conditions, wind velocity and direction will be recorded.

Annex A –  
Statement of Work – 47’ MLB Inclining and Lightship Survey

---

All mooring lines must be slack before any readings are taken. Initial “0” readings will be made on both pendulums just prior to first weight shift.

Weights must be located on the vessel in accordance with the instructions provided by the Naval Architect. Weights will be shifted a total of eight times. After each weight shift the Naval Architect will record readings at both pendulums.

## **4.0 Deliverables**

### **4.1 Report of Inclining Experiment and Lightship Survey**

The Contractor must produce an Account of Inclining and Derivation of Lightship report and must submit the report to CCG TA for review. The report must include as a minimum the following sections and subsections:

- Executive Summary
- General
  - References
  - General Information
  - Software
  - Coordinate System
  - Datum Locations
  - Hull Form
- Inclining Experiment
  - Location and Date
  - Personnel Present
  - Vessel Mooring Arrangement
  - Water Depth
  - Vessel Condition
  - Bilges and Tanks
  - Weather Condition
  - Water Density and Temperature
  - Inclining Weights
  - Pendulum Location and Lengths
  - Freeboards and Derived Drafts
  - Weight Shifts and Pendulum Deflections

Annex A –  
Statement of Work – 47’ MLB Inclining and Lightship Survey

---

- Derivation of Lightship
  - As-Inclined Condition
  - Derivation of Lightship
  - Weights to Come Off
  - Lightship Weights to Go On
  - Table of all surveyed non-lightship items per compartments.
  - Summary table of all surveyed non-lightship items per weight groups.
  
- Annex A - Section C - Inclining Experiment and Lightship Survey Checklist
- Annex A - Section D - Report of Incline Experiment and Lightship Survey
  
- Some items on board the vessel are not permanently fixed to the structure, but are considered as the lightship items, like firefighting and lifesaving equipment, fenders, etc. The report must include a simple statement listing which of these items are included in the lightship.
  
- The final report shall be delivered to CCG in electronic format. Accepted report formats are Microsoft Word Document (.docx), AutoCAD (.dwg) and Adobe Acrobat (.pdf).
  
- Source files used to create the final report including Excel tables, GHS files, AutoCAD drawings, photos, compartment survey sheets and the report on inclining and lightship survey must be delivered to the CCG with the final report.

## **Section B – 20-05-28 - Inclining Experiment Procedure[EN].pdf will be provided as a separate document at the time of solicitation.**

### **Inclining Experiment Procedure (CCG and ABS)**

Enclosed are details on an issue that was raised to us by ABS, where they emphasized their concern with regards to inclining experiment procedures that should be followed by CCG (VMM, crew, naval architects) and consultants contracted to do the work. Following these procedures will increase the accuracy and consistency for all inclining experiments across the country. This will result in reduced delays during approvals and enhance vessel safety across the fleet.

### **Background**

In the past, when CCG vessels were inspected and certified by TCMSS, the attending TC Marine Safety Inspector was responsible for witnessing the Inclining Experiment and completing the report of an inclining experiment or light vessel survey. The inclining procedure was not approved by Transport Canada but was usually reviewed by the attending TC Marine Safety Inspector prior to conducting the experiment. The completed report was filed in RDIMS, so that the information may be compared to the inclining report information submitted by the company who completed the Inclining. The consultants may have submitted the “Inclining Experiment Report” as a standalone document for TC Approval or as part of the “Stability Booklet” for T.C. Approval.

If a vessel is currently not enrolled into DSIP this procedure is still followed by the TC Marine Safety Inspector. The Standard that governs the inclining procedure that was followed in past is TP7301, Stab 2. Existing CCG vessels that are currently in DSIP with ABS, but not in Class, were only to comply with the TP 7301 with regards to requirements for conducting inclining experiment as well as stability assessment. However, TP 7301 has not been updated in many years and is missing points that have been accepted internationally by the IMO. The most relevant standard, that is going to replace TP7301 in future, is the International Code on Intact Stability, 2008 (2008 IS Code).

### **Current Status**

ABS recently had discussions with Regions with regards to the inclining experiment procedure. The major concerns were related to the following:

1. Timely submission of the inclining procedure by the consultant,
2. Approval of the procedure and
3. Application of the IS Code 2008 as a relevant standard for the inclining experiment.

According to ABS internal policy every inclining procedure has to be reviewed and approved by ABS Surveyor before the actual inclining experiment takes place. The review and approval is in place to confirm that the proposed test procedure is acceptable when compared to a recognized standard, i.e. the 2008 IS Code. Reviewed requirements such as pendulum length, minimum deflection, number of draught readings, slack v.s. pressed-up tanks, just to name few, are critical for the accuracy of the results and are well described in the IS Code 2008. Also, ABS requires that the final inclining report has to be submitted for the approval before the final review and the approval of stability booklet.

### **Procedural Agreement between CCG and ABS**

CCG Naval Architecture team in Ottawa had discussions with ABS Stability team and have come to the following conclusions:

## Annex A – Statement of Work – 47’ MLB Inclining and Lightship Survey

---

ITS/ME agrees that IS Code 2008 should be used as a guideline, as much as reasonable and practicable, recognizing that requirements might be modified due to the age or/and size of the vessel, or novel design. Typical deviation from the IS Code requirements that we can foresee in the future are for example draft/freeboard readings at the number of locations, the length of the pendulums or number of slack/full tanks.

ITS/ME agrees with the requirement that incline procedure should be submitted for review prior to the inclining experiment (at least two weeks) and the incline experiment report should be submitted for approval prior to review and approval of the stability booklet.

The following are details that we agreed upon:

### **1. Stability Test (Inclining/lightship) Procedure:**

Stability Test Procedure Submitted to ABS Engineering for review prior to the test

- a. Submittal 2 weeks ahead of the test is requested.
- b. ABS will strive for a 1 week turn around to support feedback on the procedure review prior to the test.

The following information is required in the procedure as a minimum:

- a. Identification of vessel or unit to be tested.
- b. Date and location of the test.
- c. Approximate draft and trim of the vessel or unit.
- d. Condition of the tanks.
- e. Estimated list of items (weights and locations) to be installed, removed or relocated after the survey.
- f. Schedule of events.
- g. Person or persons responsible for conducting the survey.

In addition to items a. through g. above, the following additional items are required for Inclining Test Procedures:

- h. Inclining Weight Data.
- i. Pendulum locations and lengths

The following will be verified during the review:

- a. Verify that the intended mooring conditions and location are acceptable
  - i. The mooring arrangement should ensure that the ship will be free to list without restraint for a sufficient period of time to allow a satisfactory reading of the heeling angle due to each weight shift to be recorded.
  - ii. The depth of water under the hull should be sufficient to ensure that the hull will be entirely free of the bottom.
- b. Verify that the intended freeboard and draft reading locations are acceptable
  - i. STAB 2 has no specific requirement for the number and location
  - ii. 2008 IS Code recommends 5 locations, ABS considers 3 a minimum for vessels of 24 meters and above.
- c. Verify that the expected initial trim of the vessel is acceptable
  - i. No more than 0.01 LBP per STAB 2
  - ii. 2008 IS Code request use of actual trimmed hydrostatics
- d. Verify that the expected initial list will be checked and will not exceed 0.5 degrees
  - i. STAB 2 and 2008 IS Code
- e. Verify that all tanks will be completely empty and clean, or completely full and pressed
  - i. STAB 2 and 2008 IS Code

## Annex A – Statement of Work – 47’ MLB Inclining and Lightship Survey

---

- ii. Free Surface
  - 1. STAB 2 - Excessive free surface is to be avoided
  - 2. 2008 IS Code - The number of slack tanks should normally be limited to one port/starboard pair or one centreline tank of each type.
- iii. ABS’s mission is in part to protect the marine environment, as such tanks should not be loaded to a condition that could result in a pollution event.
- f. Verify that the expected maximum pendulum deflections are acceptable
  - i. STAB 2 – that the deflection of the pendulum for each shift is sufficiently large to give meaningful readings, length to be as long as possible.
  - ii. 2008 IS Code - The pendulums should be long enough to give a measured deflection, to each side of upright, of at least 15 cm. Generally, this will require a pendulum length of at least 3 m. It is recommended that pendulum lengths of 4 to 6 m be used.
- g. Verify that the expected maximum inclination angle is acceptable
  - i. STAB 2 – 1-1/2o to 3o on each side
  - ii. 2008 IS Code - The total weight used should be sufficient to provide a minimum inclination of one degree and a maximum of four degrees of heel to each side.
- h. Verify that the intended weights and weight movements will demonstrate effective results
  - i. STAB 2 – Eight (8) movements of the weights should normally be carried out.
  - ii. 2008 IS Code - The standard test employs eight distinct weight movements, three to one side, a recheck of the initial position, three to the opposite side and a final recheck of the initial position.
- i. Verify the quantity, location and details of the devices used to measure the inclination of the vessel
  - i. STAB 2/2008 IS Code – Two pendulums are required
  - ii. 2008 IS Code – Two pendulums are required, three pendulums are recommended. Used of U-Tubes and Inclinometers in place of one pendulum (if two are used) is acceptable.
  - iii. ABS additional requirement – if only two pendulums (measuring devices) are used: For vessel’s under 40m in length, the difference between the measured heel angles for each pendulum at each weight movement may not exceed 0.15 degrees. For vessels over 40m in length, the maximum difference is 0.05 degrees.
- j. Verify that it is intended to monitor each movement by plotting heeling moment against tangent
  - i. STAB 2 – no requirement
  - ii. 2008 IS Code - A plot should be run during the test to ensure that acceptable data are being obtained
- k. Verify that it is intended to maintain a record of weights being added, removed and relocated for lightship condition
  - i. STAB 2 / 2008 IS Code – required by both documents
- l. Verify that any fixed ballast will be properly identified and documented as part of the vessel’s lightship properties
  - i. STAB 2 / 2008 IS Code – no requirement
  - ii. ABS – This is done to allow for effective tracking of permanent ballast fitted on the vessel and any modifications.
- m. Verification of Down-flooding Points (unless alternate arrangements are made with the Surveyor to do so)
  - i. STAB 2 / 2008 IS Code – no requirement
  - ii. ABS – This is a practice ABS has used to confirm the locations of down-flooding points



## Annex A – Statement of Work – 47’ MLB Inclining and Lightship Survey

---

as proper drawings on existing vessels may not be available or of sufficient detail. On Load Line vessels the Record of Conditions of Assignment (LL-11-D) may be used to identify down-flooding points. For non-Load Line vessels, this is strongly recommended for the reasons stated above.

- n. Verify that movable equipment will be in the locked/stowed position (Z-drives, crane booms, travelling block, legs, etc.)
  - i. STAB 2 – Weights capable of moving should be lashed in place.
  - ii. 2008 IS Code - movable or suspended items are secured and their position documented
  - iii. ABS note – free swinging Z-drives have been a source of unacceptable tests due to the large amount of weight being shifted as the swing.
- o. For an inclining, the draft and vessel/unit condition is to be such that the water-plane is constant while vessel/unit inclines (i.e., no anchor racks, braces, spud cans, mat, chines, etc., break the surface)
  - i. STAB 2 - changes in the waterplane area during the shifts are kept as small as possible
  - ii. 2008 IS Code - In order to avoid excessive errors caused by significant changes in the water plane area during heeling, hydrostatic data for the actual trim and the maximum anticipated heeling angles should be checked beforehand.
- p. Take water samples for the water density and temperature

### **2. Stability Test Results:**

ABS prefers to receive the report of the stability test as a standalone document for review. Alternatively, ABS have no objection to reviewing a Trim & Stability Booklet that incorporates the Stability Test Report. The ABS review of the stability test report will include the following:

1. Verify that the inclining experiment/lightweight survey was conducted in accordance with the approved procedure
2. Verify that the data verification report is received from the attending Surveyor
  - a. This is the ABS version of the TC Form 85-0187
3. Determine the "as surveyed" waterline from the freeboard and draft readings
4. Verify Hydrostatics used to calculate the lightship
5. Determine the "as surveyed" displacement and correct for trim, deflection and specific gravity
6. Determine the "as surveyed" LCG and KM values and correct for trim
7. Verify that the obtained angle of heel and maximum pendulum deflection were within the required range
8. Determine the "as surveyed" VCG and free surface
9. Determine the free surface present during the test
10. Verify the record of weights being added, removed and relocated
11. Determine Lightship particulars
12. Verify that fixed or permanent ballast has been properly identified and documented
13. Verification of Down-flooding Points if collected as part of the test

ABS understands that each vessel is unique and that there may be justifiable reasons to modify the requirements stated above, particularly in the case of small vessels (<24m) or vessels of novel design. These modifications need to be handled on a case by case basis.

Annex A –  
Statement of Work – 47’ MLB Inclining and Lightship Survey

---

## Section C - Inclining Experiment and Lightship Survey Checklist

### 1. Lightship Survey

1.1 – Pre-Lightship Survey Preparations	Yes	No	N/A
Are all the compartments to be surveyed identified?			
Are the compartments’ datums for measuring longitudinal, transverse, and vertical location of each non-lightship weight item identified?			
Are the compartment survey sheets prepared and printed?			
Are the deck plans with all compartments to be surveyed ready?			
Are the notices for surveyed compartments ready?			

1.2 – Lightship Survey	Yes	No	N/A
Are all loose weights’ items (not considered to be a lightship) per compartments identified and weighed? <i>Note: It is recommended to weigh some lightship items such as fire-fighting and life-saving equipment.</i>			
Are the non-lightship weights’ items classified into groups (e.g. crews effects, consumables, tools, etc.)?			
Are the longitudinal, transverse, and vertical location of each non-lightship weight item accurately determined and recorded?			

1.3 – Post Lightship Survey	Yes	No	N/A
Are the tables of all surveyed non-lightship items per compartments produced?			
Is the summary table of all surveyed non-lightship items per weight groups produced?			

### 2. Pre-Inclining Preparations:

2.1 - Vessel Conditions	Yes	No	N/A
Have any major items of equipment or major structural sections been added or removed?			
Is there any unnecessary gear and personnel on board the vessel?			

Annex A –  
Statement of Work – 47’ MLB Inclining and Lightship Survey

---

<b>2.2 - Weather Conditions</b>	<b>Yes</b>	<b>No</b>	<b>N/A</b>
Is there any wind? (Typically wind speed is acceptable if draft marks can be read). <i>Note:</i> <i>There can be no gusting winds, and beam winds should be avoided. Steady light wind that does not cause motion is acceptable.</i>			
Are there any strong currents?			
Is it raining?			
Are there any waves? (Ripples are acceptable, as long as drafts can be read to 2 cm)			

<b>2.3 - Mooring Arrangements</b>	<b>Yes</b>	<b>No</b>	<b>N/A</b>
Does the mooring arrangement allow the ship to freely list without restraint for a sufficient period of time?			
Is it possible to read and record the heel angle due to each weight shift?			
Has the mooring arrangement been submitted to the approval authority for review prior to the test?			
Is the depth of the water greater than the draft of the vessel?			

<b>2.4 - Tanks</b>	<b>Yes</b>	<b>No</b>	<b>N/A</b>
Are all tanks either empty or pressed full?			
Are all pressed tanks completely full (i.e. 100%) and free from air pockets? Ensure proper care is taken to prevent pollution.			
Have all empty tanks been opened and checked for liquids?			
Have all tanks containing liquid been sounded for liquid levels and the sounding levels recorded? <i>Note:</i> <i>Add a record of tank soundings to this form.</i>			

<b>2.5 - Inclining Weights</b>	<b>Yes</b>	<b>No</b>	<b>N/A</b>
Have the calculations been completed to determine the recommended heel angle of the vessel and the recommended deflection at the maximum moments? <i>Note:</i> <i>Maximum moments are obtained when all inclining weights located on one side of the ship are shifted to the opposite side. Weights initially located at the opposite side stay at their initial positions.</i>			
Is the maximum angle of heel less than 4°? (Recommended angle of heel must be between 2° and 3°)			
Is the deflection of the pendulums at the maximum moment at least 15 cm (6 in)			

Annex A –  
Statement of Work – 47’ MLB Inclining and Lightship Survey

<b>2.5 - Inclining Weights</b>	<b>Yes</b>	<b>No</b>	<b>N/A</b>
to each side of the initial position? <i>Note:</i> <i>Deflection of the 3 m (10 ft) long pendulum at the maximum angle of 4° is around 20cm (8 in).</i>			
Have the inclining weights been certified, or weighed and recorded using certified scales?			
Have at least four inclining weights been obtained for the installation? (two at each side of the ship)			

<b>2.6 – Initial Position of Inclining Weights</b>	<b>Yes</b>	<b>No</b>	<b>N/A</b>
Are the inclining weights initially positioned as close as possible to the deck edge on both the port and starboard sides of the ship?			
Have the initial positions of the inclining weights been recorded? <i>Note:</i> <i>Initial positions (vertical, transverse, longitudinal distances) are measured from known reference points such as distance above the deck, distance from the end of a deckhouse and distance from the centerline.</i>			

<b>2.7 – Initial Vessel Conditions</b>	<b>Yes</b>	<b>No</b>	<b>N/A</b>
Is the initial heel angle less than 0.5°?			
Is the trim close to even keel condition? <i>Notes:</i> <i>Trim difference less than 1 % of the LBP from even keel is recommended.</i> <i>If more trim is allowed, as-trimmed hydrostatics must be used in calculations.</i>			
Can accurate GHS model be obtained? If yes, then trimmed hydrostatics must be produced directly from the GHS hydrostatics based on the input ‘as-inclined’ drafts.			

<b>2.8 - Pendulums</b>	<b>Yes</b>	<b>No</b>	<b>N/A</b>
Are there at least two pendulums installed on the vessel? These pendulums could be located on different decks and do not have to be on the centerline.			
Are the pendulums long enough to get the required angle of deflection (i.e. pendulums must to be at least 3 m (10 ft) long)? <i>Note:</i> <i>Length of pendulums must be measured from the pivot point to the top of the batten. If the pendulum is sheltered from the wind, it is best to make the pendulum as long as possible.</i>			
Is the pendulum deflection unrestricted through the maximum angle?			

Annex A –  
Statement of Work – 47’ MLB Inclining and Lightship Survey

<b>2.8 - Pendulums</b>	<b>Yes</b>	<b>No</b>	<b>N/A</b>
Is the pendulum wire piano wire or another monofilament material?			
Is the pendulum support fixed so that it cannot be accidentally moved during the inclining?			
Can the pendulum top connection afford unrestricted rotation of the pivot point?			
Is thick oil in place inside the bucket to dampen movement of pendulums before the test begins? (Pendulums with dampers are recommended) <i>Note:</i> <i>Bucket must be big enough to accommodate shifts of the pendulum dampers to each side from the initial position for at least 25 cm (10 in). Deflection of the 10 ft long pendulum at the maximum angle of 4° is around 8 in. (see sub-section 2.5).</i>			

<b>2.9 - Battens</b>	<b>Yes</b>	<b>No</b>	<b>N/A</b>
Are the battens placed over or on top of the oil buckets?			
Are all battens made of smooth light colored wood? <i>Note:</i> <i>½ inch thick batten is recommended.</i>			
Are pencil marks placed on battens to record the position of the pendulum wires?			
Are the battens fixed so that they cannot be accidentally moved during the inclining?			
Have the battens been reset once the inclining began and movements were being recorded? <i>Note:</i> <i>It is important that the battens are <b>never</b> reset.</i>			
Are the battens aligned close to the pendulum? <i>Note:</i> <i>Battens should be aligned close to the pendulum, but cannot come into contact with it.</i>			

<b>2.10 - Hydrometer and Thermometers</b>	<b>Yes</b>	<b>No</b>	<b>N/A</b>
Have the hydrometer and thermometers (for specific gravity and temperature measurements) been calibrated prior to the inclining experiment?			

<b>2.11 – Other Equipment</b>	<b>Yes</b>	<b>No</b>	<b>N/A</b>
Have the other equipment for the inclining experiment been prepared (e.g. measuring tapes, pencils, graph paper, chalk, scales, draft tubes, ...)?			

**3. Inclining Experiment**

Annex A –  
Statement of Work – 47’ MLB Inclining and Lightship Survey

<b>3.1 – Draft Readings</b>	<b>Yes</b>	<b>No</b>	<b>N/A</b>
Have draft readings been taken at the draft marks?			
Have photos been taken?			
Are the draft mark measurements being taken from a small boat? If yes, then the boat weight must be taken as the lightship item in the derivation of lightship.			
Has the datum line for the draft marks been verified from the drawings? (i.e. bottom of the keel or baseline)			
Have the longitudinal locations of the draft marks from a known reference point been taken from the drawings?			
Has the keel plate thickness been verified from the drawings and taken into account for the draft mark readings?			
Has the rake of the keel been verified from the drawings and taken into account?			

<b>3.2 – Hydrometer and Thermometer Readings</b>	<b>Yes</b>	<b>No</b>	<b>N/A</b>
Have the hydrometer and thermometer readings for specific gravity and temperature been taken at several longitudinal sections around the vessel? <i>Note:</i> <i>Add a record of hydrometer and thermometer readings as well as reading locations to this form.</i>			

<b>3.3 - Battens</b>	<b>Yes</b>	<b>No</b>	<b>N/A</b>
Are the battens over or on top of the oil buckets placed at the pendulum locations?			

<b>3.4 – Inclining Weights</b>	<b>Yes</b>	<b>No</b>	<b>N/A</b>
Are the inclining weights installed at the initial positions?			

<b>3.5 – Inclining Weight Movements</b>	<b>Yes</b>	<b>No</b>	<b>N/A</b>
Are the inclining weights moved, as recommended, to meet the following requirements? <i>Notes:</i> 1. <i>At least two movements from the reference position to the opposite side and back have been conducted.</i> 2. <i>During each movement, it is ensured that:</i> <ul style="list-style-type: none"> <li>• <i>There is no taut mooring lines other than those attached to temporary pads on centerline;</i></li> <li>• <i>Pendulum weight is not touching side of bucket; and</i></li> <li>• <i>Pendulum is not touching batten.</i></li> </ul>			

Annex A –  
Statement of Work – 47’ MLB Inclining and Lightship Survey

3.6 – Moment Tangent Curve	Yes	No	N/A
<p>Has the moment-tangent curve been plotted during the test weights shifts to validate the accuracy of the experiment?</p> <p>Notes:</p> <ol style="list-style-type: none"> <li>1. <i>Heeling moment equals weight times distance moved. It is plotted on abscissa.</i></li> <li>2. <i>Tangent of the heeling angle equals pendulum deflection divided by pendulum length. It is plotted on the ordinate.</i></li> <li>3. <i>Plot must be a straight line but it doesn't have to pass through the origin.</i></li> <li>4. <i>Deviation from the straight line indicates that there are other moments acting on the ship, as well as uncounted effects of free surface or the vessel is touching the bottom and should not be accepted.</i></li> </ol>			

**4. Post-Inclining**

4.1 – Ensure Completion of the Following	Yes	No	N/A
Have the drafts/freeboards been checked to ensure consistency with the first measurements?			
Have the tanks been surveyed if the drafts changed?			
Is the form given in Appendix C of SOW verified and signed?			

Annex A –  
Statement of Work – 47’ MLB Inclining and Lightship Survey

---

**Section D – Report of Incline Experiment and Lightship Survey**

Name of vessel:			Inclining experiment location:		Date of experiment (dd-mm-yyyy):	
IMO number:			Condition of vessel:		Type of vessel:	
Drafts at inclining			Weather conditions:		Vessel's heading with regard to wind:	
Aft	Forward	Midship	Displacement at inclining :	Water depth:	Average temperature of water:	
Port: Stbd:	Port: Stbd:	Port: Stbd:			Average density of water:	
Mooring arrangement :			Was vessel free to incline?		Location and amount of permanent ballast:	
Datum line is:		Rake of keel:		Inclining weights:		Shift of weights:
Pendulum aft		Pendulum fwd		Condition of bilges, tanks, and voids:		
Length: Position:		Length: Position:				

Inclining experiment heeling measurement				Pendulum readings	
Shift #	Weight moved	Distance moved	Direction	Forward:	Aft:
0	N/A	N/A	Start Position		
1					
2					
3					
4					
5					
6					
7					
8					



Annex A –  
Statement of Work – 47’ MLB Inclining and Lightship Survey

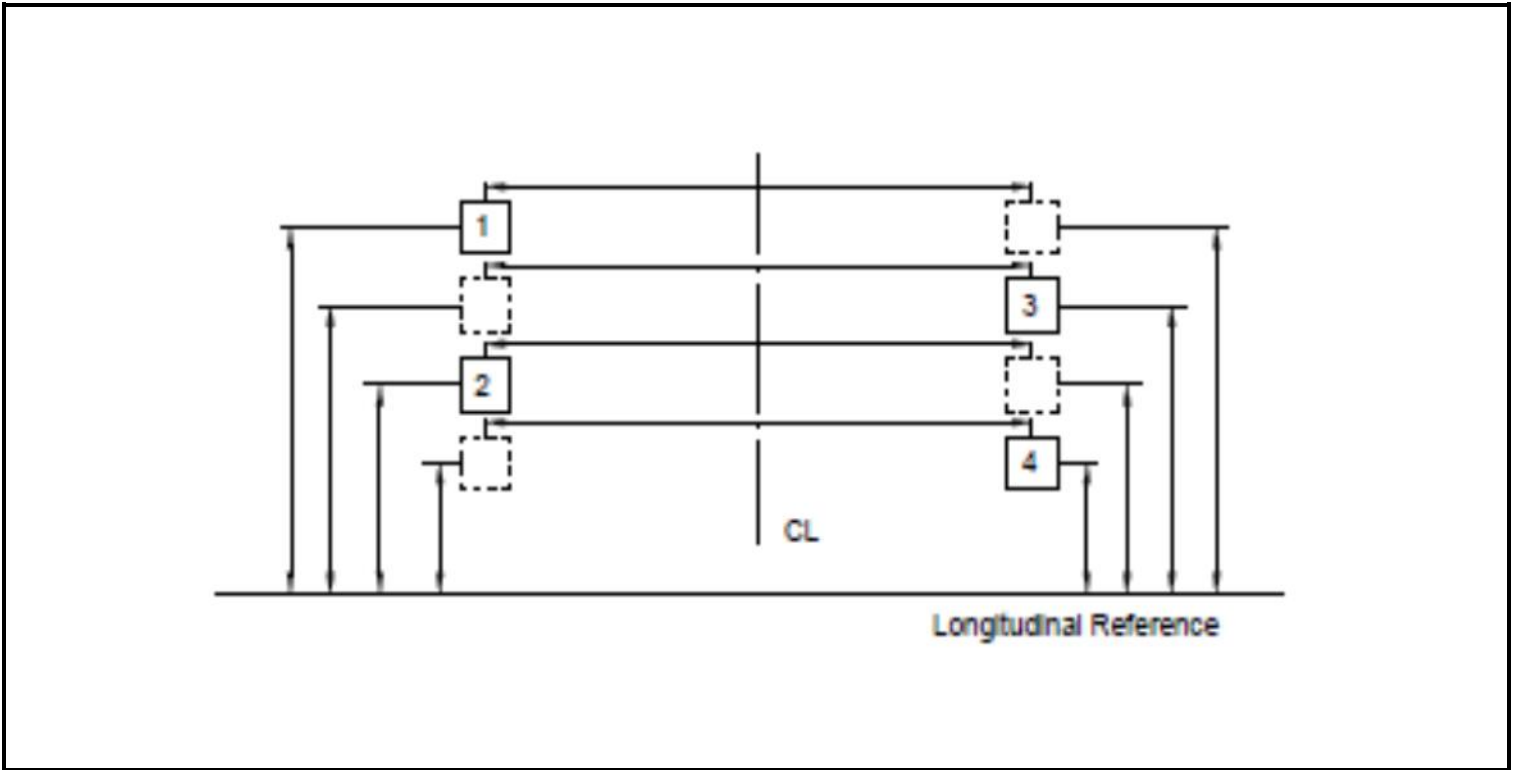

Items that were onboard the vessel during inclining experiment to be DEDUCTED from inclined condition. These items are typically not onboard the vessel.								
#	Items deducted	Weight	VCG	LCG	TCG	V. Moment	L. Moment	T. Moment
<b>TOTAL</b>								

Annex A –  
Statement of Work – 47’ MLB Inclining and Lightship Survey

Items that were removed from the vessel during inclining experiment to be ADDED to the inclined condition. These items are typically onboard the vessel.								
#	Items deducted	Weight	VCG	LCG	TCG	V. Moment	L. Moment	T. Moment
<b>TOTAL</b>								

Issued at \_\_\_\_\_ on \_\_\_\_\_  
 (Place) (Date: dd/mm/yyyy)

\_\_\_\_\_  
 (Signature – Contractor)

\_\_\_\_\_  
 (Signature – CGTA)

## Appendix A – Original 47’ MLB Equipment Suppliers List

Suppliers	Address	Telephone	Fax
A. R. Thomson Group	7930-130th Street, Surrey BC, V3H 0H7	604-507-6050	604-507-6098
Acklands-Grainger Inc.	2015 Government St., Victoria BC, V8T 4N9	250-384-1111	250-384-2800
Acme Fire and Safety Co. Ltd.	3427 Kingsway, Vancouver BC, V5R 5L3	604-437-8555	604-436-1301
Aktiv Controls	120-2544 Douglas, R Burnaby BC, V5C 5W7	604-294-1345	604-294-4679
Albrite Lighting Co.	816 Cloverdale Ave., Victoria BC, V8X 2S8	250-475-1999	250-475-1966
Alpine Aerotech Ltd.	1260 Industrial Rd., Kelowna BC, V1Z 1G5	250-769-6344	250-769-6303
Areo-Feu Ltee.	615 Boul. Guimond, Longueuil PQ, J8G 1L9	450-651-2240	450-651-1970
Brenco Industries	10030 River Way, No Delta BC, V4G 1M9	604-584-2700	604-584-2702
Britmar Marine Ltd.	179 Harbour Ave., North Vancouver BC, V7J 2E7	604-983-4303	604-983-4313
Canadian Tire	2959 Douglas Street, Victoria BC, V8T 4N1	250-361-3152	
Chambers Industrial Supply Inc.	5608 Salmen Rd., Harahan LA, 70123	504-737-2288	504-734-0738
Chimo Marine Co. Ltd.	1660 Powell Street, Vancouver BC, V5L 1H4	604-253-4125	604-253-7679
CMC Electronics	3839 Still Creek Ave, Burnaby BC, V5C 4E2	604-435-1455	604-435-2231
Coast Industrial Parts Ltd.	562 Dupplin Rd., Victoria BC, V8Z 1C1	250-475-3202	250-475-3204
Columbia Valve & Fitting Ltd.	117-8678 Greenall Ave, Burnaby BC, V5J 3M6	604-629-9355	604-630-3299
Comnav Marine Ltd. #15	13511 Crestwood, Richmond BC, V6V 2G1	604-207-1600	604-207-8008
Cowichan Hydraulics	1580-M Willow Street, Campbell River BC, V9W 3M7	250-287-3535	250-990-1818
Custom Gaskets Ltd.	975 West Kent Ave, Vancouver BC, V6P 6K8	604-263-1426	604-263-7825
D & R Electronics Co. Ltd.	881 Edgely Blvd., Concord ON, L4K 4V9	905-660-0670	905-660-8034
DBC Marine Safety Systems	101-3760 Jacombs R Richmond BC V6V 1Y6	604-214-4282	604-278-7812
DMC Clad Metal Products	5405 Spine Road Boulder CO 80301	303-604-3906	303-604-1893
Donovan Marine Inc.	6316 Humphreys St. Harahan LA 70123	504-488-5731	504-486-3258
DSS Marine	152 Rocky Lake Driv Bedford NS B4A 2T6	902-835-4848	902-835-6269
Edmonds Batteries Ltd.	7471 Edmonds Street Burnaby BC V3N 1B3	604-525-8144	604-525-5880
Electrical Cable Supply	13330 Maycrest Way Richmond BC V6V 2J7	604-276-9913	604-276-9915
Emergency Response Systems Inc.	5730 Production Way Langley BC V3A 4N4	604-514-3636	604-514-3635
Finning Power	#120-15100 River Rd Richmond BC V6V 1L5	604-231-3900	604-231-3910
Flagship Marine Inc.	2427 SE Dixie Hwy. Stuart FL 34996	561-283-1609	561-283-4611
Forster Instruments Inc.	7141 Edward Blvd. Mississauga ON L5S 1Z2	905-795-0555	905-795-0570
Foster Air Conditioning	549 Kelvin Rd. Victoria BC V8Z 1C4	604-475-0500	604-475-7588
Freeman Marine Equipment	28336 Hunter Creek Gold Beach OR 97444	541-247-7078	541-247-2114
Glentech Inc.	46 Fourth St. Somerville NJ 08876	908-685-2205	908-685-1626
Goodall Rubber Co.	2612 Turner Victoria BC V8T 4T9	250-386-2136	250-386-1516
Hi-Line Aluminum	13060 No. 2 Road Richmond BC V7E 2G1	604-274-0222	604-274-8774
Hypro Marine	Mount Pleasant Lane, Lymington Hampshire, UK S0R18LS	44-1590-681445	44-1590-68140
Indufast	1-477 Boleskine Rd. Victoria BC V8Z 1E7	250-475-6334	250-475-6345
Industrial Plastics and Paints	3944 Quadra Street Victoria BC V8X 1J6	250-727-3545	250-727-7066
Integriss Metals Inc.	12311 Horseshoe W Richmond BC V7A 4X6	604-272-2422	604-272-9137
International Engineered Products Inc.	131 Church Street Charleston SC 29401	843-723-8006	843-577-2299
Jastram Technologies Ltd.	188 Bunting Rd. Unit St. Catharines ON L2M 3Y1	905-641-2587	905-641-5267
Jered Industries (NETEC)	620 Golf Club Rd. Newton Square PA 19073	610-356-1952	610-356-3406
Jet Signs	765 Burnett Street Kingston ON K7M 5W2	613-389-7446	613-389-6669
L.C. Doane Company	PO Box 975 Essex CT 06426	860-767-8295	860-767-1397
LaMarche Mfg Co.	106 Bradrock Dr. Des Plaines IL 60018-1967	847-299-1188	847-299-3061
Lee Spring Co.	1-462 62nd Street Brooklyn NY 11219	718-236-2222	718-236-3919
Lifesaving Systems Corp.	220 Elsberry Road Apollo Beach FL 33572-2289	813-645-2748	813-645-2768
Louisiana Assoc. for the Blind	1750 Claiborne Ave. Shreveport LA 71103	318-227-2869	318-635-8902
M. Kool Transportation Products Inc.	1855 Blvd. Industriel, Laval PQ H7S 1P5	450-668-2286	450-668-2286
Martime Services	3440 Bridgeway Street, Vancouver BC V5K 1B6	604-294-4444	604-294-5879
McMaster-Carr Supply Company	PO Box 54960 Los Angeles CA 90054-0980	562-692-5911	562-695-2323
Meridian Specialties Inc.	2800 Viking Way Richmond BC V6V 1N5	604-278-4640	604-278-7515
Montreal Valve	9130 Avenue du Par Montreal PQ H2N 1Z2	514-389-7881	514-389-2148
Nedco 3125	Steel Street Victoria BC V8Z 3N7	250-373-1116	250-388-4946
New England Trawler Equipment Co.	620 Golf Club Road Newton Square PA 19073	610-356-1952	610-356-3406
Ohler Machinery	501 Maple Street Jamesville IA 50647	319-987-2121	319-987-2161

## Appendix A – Original 47’ MLB Equipment Suppliers List

Old Country Equipment Rentals	2200A Keating X Roa Victoria BC V8M 2A6	250-883-2556	250-652-8713
Olympic Foundry Inc.	5200 Airport Way So Seattle WA 98108	206-764-6200	206-764-1171
Payne's Marine Supply	2120 Quadra Street Victoria BC V8T 4C5	250-382-7722	250-382-4043
Pete's Tent and Awning	252 Island Highway Victoria BC V9B 1G2	250-479-9124	250-479-9346
Pierce Aluminum Company Inc.	34 Forge Park PO Bo Franklin MA 02038	800-336-1358	508-541-6077
Production Supply Co. Inc.	20826-68th Ave. Sou Kent WA 98023	425-251-8550	425-251-9065
Professional Mariner	232 International Dr. Portsmouth NH 03801	603-433-4440	603-433-4442
Purity Alloys	15-18503 97th Ave. Surrey BC V4N 3N9	604-888-0181	604-888-8313
Radio Works	7-555 Ardersier Rd. Victoria BC V8Z 1C8	604-475-3400	604-475-3444
Reilly-Benton Insulation Company	PO Box 10279 New Orleans LA 70181-0279	504-734-1711	504-734-1761
Safety First Fire Prevention Inc.	2805 Boul. Losch St.-Hubert PQ J3Y 3V6	514-866-8683	250-445-4250
Signal Technologies	1427 Ogilvie Rd. Gloucester ON K1J 8M7	613-742-1580	613-741-1561
Sinclair Technologies Inc.	616 Chester Rd. Delta BC V3M 5V8	604-525-5344	604-525-5345
STIDD Systems Inc.	220 Carpenter St., P Greenport NY 11944	631-477-2400	631-477-1095
TCH Sales Inc.	40 Emblem Court Toronto ON M1S 1B1	416-299-0089	416-299-3255
Telcor Marine Instruments Inc.	17785-M Sky Park Cir Irvine CA 92714	949-250-1016	949-250-1014
The Gilman Corporation	PO Box 68 Gilman CT 06336-0068	860-887-7080	860-886-5402
Transtar Metals	4342 Michaud Blvd. New Orleans LA 70129	504-254-0505	504-254-9043
Trentfab Inc.	PO Box 698 10 Douglas, Trenton ON, K8V 5W6	613-394-9993	613-394-5545
Trotac Marine Ltd.	85 Dallas Rd., Victoria BC, V8V 1A1	250-386-2341	250-386-3574
Van Isle Water Services Ltd.	600B Frances Ave., Victoria BC, V8Z 1A3	250-383-7145	250-383-1216
Vernon Manufacturing Corporation	Black Diamond Rd., B Belleville ON, K8N 4Z9	613-968-3231	613-968-7190
Victoria Marine Electric	31 Erie Street, Victoria BC, V8V 1P8	250-383-9731	250-382-6153
VM Dafoe Machine Shop	1332 Powell St., Vancouver BC, V5L 1G6	604-254-1116	604-254-4797
Wajax Industries	16745 111th Ave., Edmonton AB, T5M 2S4	780-483-4466	780-487-6979
Wesco Distribution Canada Inc.	481 Cecilia Rd., Victoria BC, V8T 4T4	250-382-7265	250-382-5334
West Coast Alloys and Tube	#140-6260 Graybar, Richmond BC, V6W 1H3	604-270-8851	604-273-4363
Western Marine	1494 Powell Street, Vancouver BC, V5L 5B5	604-253-7721	604-253-2656
WL Marine Services	258 East First St, North Vancouver BC, V7L 1B3	604-980-2173	604-980-6783

## Appendix B – Alternate 47’ MLB Equipment Suppliers List

### Appendix B – Alternate/Additional Suppliers

Supplier Name	Address	Telephone	Fax
Advanced Motor Solutions	659 Parkdale Ave N, Hamilton ON, L8H 5Z1	905-481-1131	905-481-2257
Don Brenton’s	2 Lakeside Park Drive, Unit 5, Lakeside NS, B3T 1L7	902-876-7879	902-876-1976
EMCO	15 Riverside Dr, Charlottetown PE, C1A 9R9	902-566-3340	902-368-1915
Firwin Corporation	1685 Flint Rd, North York, ON M3J 2W8	416-907-4093	416-745-0782
Guildfords	25 Guildford Avenue, Dartmouth. NS, B3B 0H5	902-481-7900	902-468-5052
Jastram Technologies Ltd	22 Trider Cres, Dartmouth NS, B3B 1R6	902-468-6450	902-468-6901
Lengkeek Vessel Engineering	11 Portland Street, Suite 301, Dartmouth NS, B2Y 1H1	902-468-3094	902-468-2910
MarineNav Ltd	Panmure Island Rd, Panmure Island, PE C0A 1R0	902-838 7011	
Mermaid Marine	26 Fourth Street Charlottetown PE C1E 2B3	902-566-1220	902-368-3660
Stright-MacKay Ltd	PO Box 97 New Glasgow NS B2H 5E1	902-928-1900	902-928-1905

## Appendix C – Fire System Signage

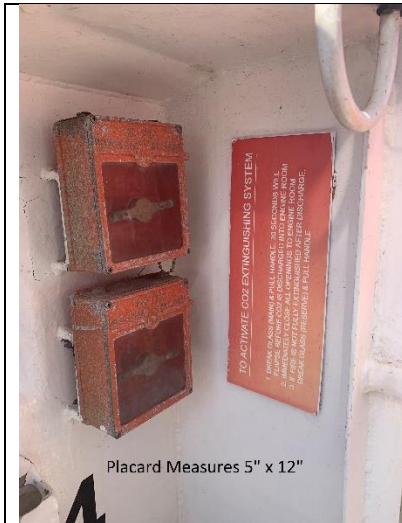

Placard Measures 5" x 12"

Sign to be made to read vertically for this location.



Placard Measures 3.5" x 2"



Placard measures 3.5" x 2"



Placard Measures 3.5" x 2"

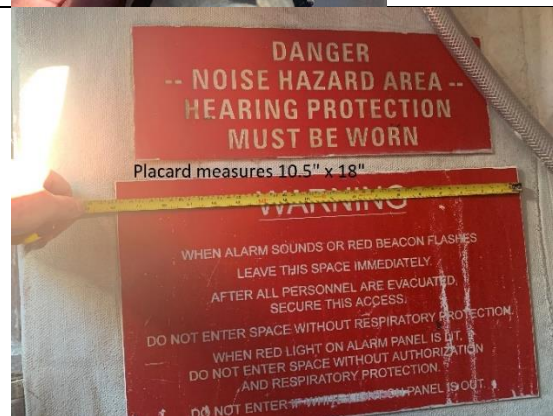



Placard measures 10.5" x 18"





Placard Measures 10.5" x 18"

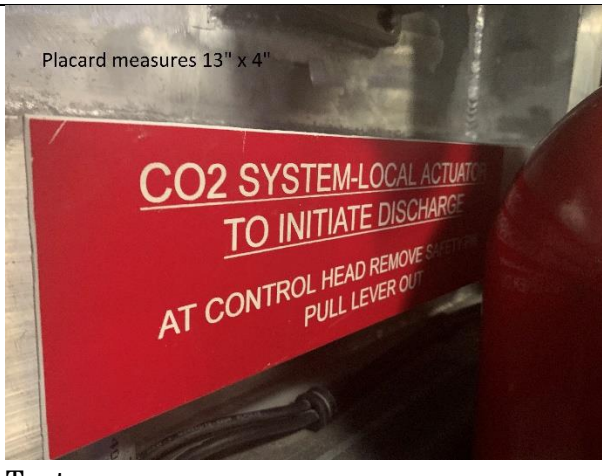

## Appendix C – Fire System Signage

<p>DANGER -ZONE DE BRUIT- PROTECTION AUDITIVE DOIT ETRE PORTÉ</p>	
 <p>Each Placard Measures 8" x 2"</p>	 <p>Placard measures 5" x 2"</p> <p>ARRÊT CARBURANT D'URGENCE</p>
 <p>Placard measures 13" x 4"</p>	 <p>Placard measures 13" x 4"</p>
<p>Text <u>CO2 SYSTEM-TIME DELAY TO OVERRIDE 30 SECOND DELAY</u> AT CONTRL HEAD REMOVE SAFETY PIN AND PULL LEVER UP</p> <p>SYSTÈME CO2 - TEMPORISATION POUR CONTOURNER DÉLAI 30 SECONDES</p>	<p>Text <u>CO2 SYSTEM LOCAL ACTUATION TO INITIATE DISCHARGE</u> AT CONTROL HEAD REMOVE SAFETY PIN AND PULL LEVER OUT</p> <p>SYSTÈME CO2 ACTIVATION LOCALE POUR INITIER DÉCHARGE ENLEVER LA GOUPILLE ET ACTIONNER LE</p>

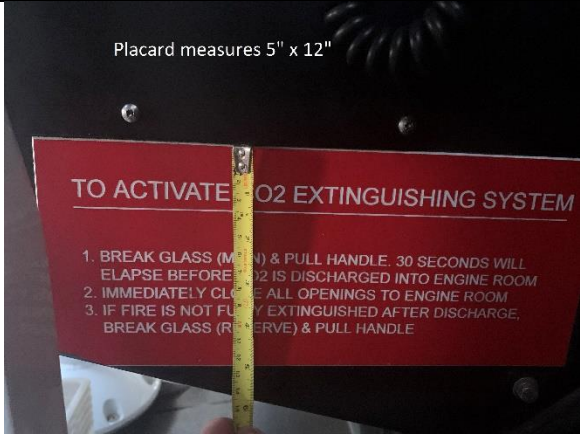
## Appendix C – Fire System Signage

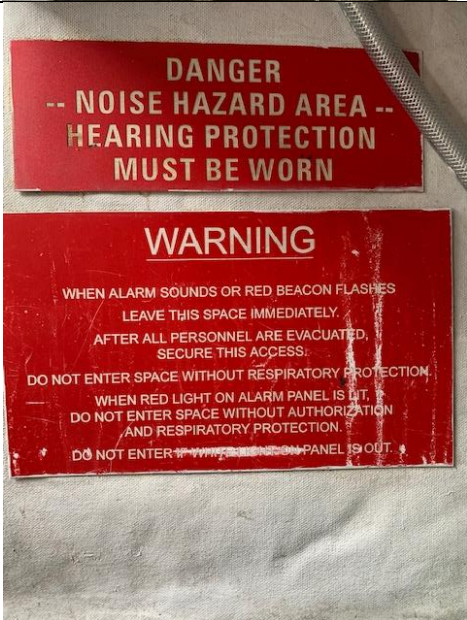
ENLEVER LA GOUPILLE ET TIRER LEVIER VERS LE HAUT	LEVIER
 <p>Placard measures 5" x 12"</p> <p><b>Text</b> See spec item 3.1.5.1 for text</p>	 <p>All 4 placards measure 6" x 12.5"</p>
 <p><b>Size:</b> 10.5"h x 18" w</p>	 <p><b>Size:</b> 10.5"h x 18" w</p>



## Appendix D – Parts List

### Government Supplied Material

Spec #	Part Description	Manufacturer	Model/Part #	Quantity
E-111	Multi-Function Display 9in	Simrad	NSS9 EVO3S	2
E-111	Multi-Function Display 12in	Simrad	NSS12 EVO3S	1
E-111	Ethernet Hub	Simrad	NEP-2	1
E-112	Open Array Radar	Simrad	Halo 4	1
E-112	Radar Interface Box	Simrad	RI-12	1
E-113	ECS Monitor	MarineNav	CGElite 12	2
E-114	ECS Computer	MarineNav	Leviathan 17i Fanless	1
E-115	Navigation Instrument Display	Simrad	IS42	4
E-121	Rudder Feedback Unit	Simrad	RF25N	1
E-121	Autopilot Computer	Simrad	NAC-3	1
E-121	Autpilot Head	Simrad	AP48	1
E-121	Autopilot Follow Up Remote	Simrad	FU80	1
E-123	VHF Wideband Radio including: (1) Transceiver) (1) Power Supply (2) Control Head (2) Microphone	Motorola	APX8500	1
E-123	Speaker	Motorola	HSN4032	1
E-123	Speaker Water Resistant	Motorola	HSN4040	3
E-126	VHF Direction Finder Control Unit	Rhotheta	RT-8552-200	1
E-126	VHF Direction Finder Antenna	Rhotheta	RT-8551	1
E-126	Antenna Unit Mast Flange	CCG	N/A	1
E-126	Antenna Gasket	CCG	N/A	1
E-126	Enclosure with Amplifier and transformer	CCG	N/A	1
E-126	External Speaker	May vary	May vary	1

## Appendix D – Parts List

### Contractor Supplied Material

Spec #	Part Description	Manufacturer	Model/Part #	Quantity
H-2	Conventional Smoke Detector EC-P	Consilium	5200175-00A, 5200178-00A, 046950	1
H-2	Heat Detector	Kidde-Fenwal	27121-20 @ 225F	1
H-2	Stainless Steel Lockout Valve with Limit Switch	Kidde-Fenwal	10611108	1
H-2	Dual Pull Mechanism	Kidde-Fenwal	81-840058-000	2
H-2	Mechanical Pull Box	Kidde-Fenwal	81-871403-000	2
H-2	Pressure Operated Switches	Kidde-Fenwal	81-486536-000	2
H-2	Safety Outlet	Kidde-Fenwal	81-803242-000	1
H-2	Discharge Indicator	Kidde-Fenwal	81-967082-000	1
H-2	Kidde Flexible CO2 Hose	Kidde-Fenwal	81-252184-000	2
H-2	Kidde Valve Rebuild Kits (1/2")	Kidde-Fenwal	81-994706-500	2
H-2	Corner Pulley	Kidde-Fenwal	WK-844648-000	10
H-15	Non-Metallic Sleeve Bearings	Johnson Cutless	2 1/2"	4
H-15	Shaft Seals	PSS	2.5 400	2
H-19	Rebuild kit	Groco	VD-2500-S/VD-3	2
H-21	High Mount G-Force with Folding Footrest	Shockwave	SWP-1156A S2A	1
H-21	High Mount G-Force with Folding Footrest	Shockwave	SWP-1157A S2A	1
H-21	G-Force Flip Up Seat With Deck Adapter	Shockwave	SWP-1154A S3A	1
H-21	G-Force Seat With Deck	Shockwave	SWP-1155A S3A	1
H-21	High Pressure Pump	Shockwave	SW-01983	2
H-25	Motor	Parvalux	PM3d M	4
H-25	Straight Line Wiper	Wynn	Type C	4
H-27	Blower	ATTWOOD	Turbo 3000, 250 CFM	2
H-28	Non skid deck decal kit for 47' MLB	3M	710 Safety Walk	1
H-30	MLB FENDER, BOW	Gilman	47 MLB-011-BW	1
H-30	MLB FENDER, STERN	Gilman	47 MLB-011-ST	1
H-30	Fender MLB MID RAIL (PORT)	Gilman	47 MLB-011-MP	1
H-30	Fender MLB MID RAIL (STBD)	Gilman	47 MLB-011-MS	1

## Appendix D – Parts List

H-30	Fender MLB LOWER RAIL (PORT)	Gilman	47 MLB-011-LP	1
H-30	Fender MLB LOWER RAIL (STBD)	Gilman	47 MLB-011-LS	1
M-50	AVM Computer System	MarineNav	SYP-AVM-001	1
M-50	Alarm Acknowledge Button	MarineNav	SYP-AVM-ACK	1
M-50	Data Backup & Restore Kit	MarineNav	SYP-AVM-010	1
M-50	BNC Splitter	MarineNav	SYP-AVM-BNC	1
M-50	Buzzer	MarineNav	SYP-AVM-BUZZER	1
M-50	Engine Room Camera	MarineNav	SYP-AVM-CAM	1
M-50	CO Detector	MarineNav	SYP-AVM-CO	1
M-50	Horn	MarineNav	SYP-AVM-HORN	1
M-50	GPS/Satellite Position Integrated Receiver	MarineNav	SYP-AVM-GPS-SAT	1
M-50	AVM Wireless Monitoring Tablet	MarineNav	SYP-AVM-TAB	1
M-50	Ethernet to Wireless Cellular Modem	MarineNav	SYP-AVM-MODEM	1
M-50	Pan/tilt/Zoom Camera	MarineNav	SYP-AVM-CAM-PTZ	1
M-50	Windows 10 Pro-64 Licence Key with Disc	MarineNav	SYP-SOFT-OS-WIN10PRO-64	1
M-50	Enclosed Bridge display	MarineNav	CG-ELITE-12	1
M-50	Open Bridge display	MarineNav	CG-ELITE-12	1
M-51	Whale - Gusher Pump	Whale	BP3020	1
M-52	CGP1B-GX120 high pressure pump	Darley	CGP1B-GX120	1
M-53	Caterpillar C12 Diesel Marine Propulsion Engines	Caterpillar	C12	2
M-53	Twin Disc MGX5114RV gearboxes	Twin Disc	MGX5114RV	2
M-53	Twin Disc EC300 Marine Control System	Twin Disc	EC300	3
M-54	Carbon grounding brush (as per drawing 47B MLB 633-010 – Cathodic Protection)	N/A	N/A	2
M-55	Rudders IAW Drawing Number 47B MLB 562-010 – Rudder Construction	N/A	N/A	2
M-56	Propeller nut, Bronze, IAW Drawing Number 47B MLB 243-010 – Propeller, Shafting, Bearings and Seals	N/A	N/A	2

## Appendix D – Parts List

M-56	Jam nut, Bronze, IAW Drawing Number 47B MLB 243-010 – Propeller, Shafting, Bearings and Seals	N/A	N/A	2
M-56	Cotter Pin, Stainless Steel, IAW Drawing Number 47B MLB 243-010 – Propeller, Shafting, Bearings and Seals	N/A	N/A	2
M-56	Propeller Key, IAW Drawing Number 47B MLB 243-010 – Propeller, Shafting, Bearings and Seals	N/A	N/A	2
M-56	Complete Rope Cutter Assembly, IAW Drawing Number 47B MLB 243-010 – Propeller, Shafting, Bearings and Seals	Spurs	2.5 inch, Type E	2
M-56	2 ½" Propeller Shaft, Aquamet 22, IAW Drawing Number 47B MLB 243-010 – Propeller, Shafting, Bearings and Seals	N/A	N/A	2
M-56	Strut Shaft Bearing, IAW Drawing Number 47B MLB 243-010 – Propeller, Shafting, Bearings and Seals	Josie/Johnson	2.5"ID x 3.374/.377 OD, 10" long	2
M-56	Stern tube Shaft Bearing, IAW Drawing Number 47B MLB 243-010 – Propeller, Shafting, Bearings and Seals	N/A	N/A	2
M-56	PSS 2.5 400 Shaft Seal, IAW Drawing Number 47B MLB 243-010 – Propeller, Shafting, Bearings and Seals	PSS	2.5 400	2
M-56	Coupling Flange, IAW Drawing Number 47B MLB 243-010 – Propeller, Shafting, Bearings and Seals	N/A	N/A	2

## Appendix D – Parts List

M-56	Coupling Key, IAW Drawing Number 47B MLB 243-010 – Propeller, Shafting, Bearings and Seals	N/A	N/A	2
M-56	Coupling Bolt, IAW Drawing Number 47B MLB 243-010 – Propeller, Shafting, Bearings and Seals	N/A	N/A	2
M-56	Drivesaver Coupling, IAW Drawing Number 47B MLB 243-010 – Propeller, Shafting, Bearings and Seals	Globe Rubber Works Inc	7256PR	2
M-57	Complete exhaust system insulation	Firwin		2 sets
M-58	Helm Unit	HyproMarine	HM1099/2.75	1
M-58	Integrated Power Cylinder/Servo/Valve Assembly	HyproMarine	HM1647	1
M-58	Combined reservoir assembly	HyproMarine	HM2042	
M-58	Parker Gear Pumps	Parker	SAE spline shaft 11 tooth 16/32 pitch, 8 cm <sup>3</sup> /rev (0.49 cu in/rev) displacement Rear SAE ports CW rotation, 2 bolt A flange	2
M-58	18" Diameter Steering Wheel	HyproMarine	HM1168	1
M-58	Joystick Assemblies	HyproMarine	HM1973	3
M-58	Feedback Reference Unit	HyproMarine	HM1094	1
M-58	Control Electronics Assembly	HyproMarine	HM2106	1
M-58	Jog Steering Cancel, Push Button Assemblies	HyproMarine	HM2107	2
M-58	Display Meters Complete With Gaskets	HyproMarine	HM1096	2
M-58	Clevis Ends, Stainless Steel Type	HyproMarine	HM2045	2
M-58	Autopilot Pump Assembly, 12 Volt Reversing Type	HyproMarine	HM2072	1
M-58	Seal Kit For Helm Unit HM1099	HyproMarine	HM2138	1
M-58	Seal Kit For Servo Assembly HM1870	HyproMarine	HM1647	1

## Appendix D – Parts List

M-58	Seal Kit For Reservoir Assembly HM2042	HyproMarine	HM2229	1
M-58	Seal Kit For Power Pump HM1886/8	HyproMarine	HM2771	1
M-58	Micro Filter Element	HyproMarine	HM1272	1
M-60	HVAC Unit	Flagship Marine	FMAC16R	2
M-61	HVAC Cooling Pumps	Flagship Marine	MS1200, 1200 GPH	2
E-101	Battery Charger	LaMarche Constavolt	A41-60-24V-A1_12L- 10055	1
E-102	Maintenance Free Batteries	Caterpillar	8D 153-5720	4
E-103	NUC Light - red, 360 degrees, base mount	DHR	9515	4
E-103	Anchor light, white, 360 degrees	DHR	41 9510	1
E-103	Tow light, amber, 135 degrees, rear mount	DHR	41 9518	1
E-103	Blue Flashing light	DHR	N/A	1
E-103	Stern light - white, 135 degrees, rear mount	DHR	41 9514	1
E-103	Restrict Man light - white, 360 degrees	DHR	41 9510	2
E-103	Masthead light - white, 225 degrees, rear mount	DHR	41 9513	2
E-103	Starboard light, side mounted	DHR	40 9512	1
E-103	Port light, side mounted	DHR	40 9511	1
E-104	Breaker, 15 Amp, 120 Volt, 2 pole	Carling Tech	AA2-B0-34-615-5B1-C	5
E-104	Breaker, 20 Amp, 120 Volt, 2 pole	Carling Tech	AA2-B0-34-620-5B1-C	4
E-104	Breaker, 40 Amp, 120 Volt, 2 pole	Carling Tech	AA2-B0-34-640-5B1-C	1
E-104	Breaker, 12 VDC, 50 Amp, 2 pole	Carling Tech	AA2-B0-34-650-5B1-C	1
E-104	Breaker, 12 VDC, 20 Amp, 1 pole	Carling Tech	AA1-B0-34-620-3B1-C	1
E-104	Breaker, 12 VDC, 10 Amp, 1 pole	Carling Tech	AA1-XO-09-708-X11-P	4
E-104	Breaker, 12 VDC, 7.5 Amp, 1 pole	Carling Tech	AA1-B0-34-475-3B1-C	2
E-104	Breaker, 12 VDC, 5 Amp, 1 pole	Carling Tech	AA1-B0-34-450-3B1-C	1
E-104	Breaker, 24VDC, 250 Amp 2 pole	Heinemann	GJ2H3DU-W	1
E-104	Breaker, 24VDC, 50 Amp, 2 pole	Carling Tech	AA2-B0-34-650-5B1-C	2
E-104	Breaker, 24VDC, 40 Amp, 2 pole	Carling Tech	AA2-B0-34-640-5B1-C	2
E-104	Breaker, 24VDC, 30 Amp, 1 pole	Carling Tech	AA1-B0-34-630-3B1-C	5
E-104	Breaker, 24VDC, 20 Amp, 1 pole	Carling Tech	AA1-B0-34-620-3B1-C	1
E-104	Breaker, 24VDC, 15 Amp, 1 pole	Carling Tech	AA1-B0-34-615-3B1-C	18
E-104	Breaker, 24VDC, 10 Amp, 1 pole	Carling Tech	AA1-XO-09-708-X11-P	24

## Appendix D – Parts List

E-104	Breaker, 24VDC, 7.5 Amp, 1 pole	Carling Tech	AA1-B0-34-475-3B1-C	4
E-104	Breaker, 24VDC, 5 Amp, 1 pole	Carling Tech	AA1-B0-34-450-3B1-C	13
E-104	Breaker, 120 Volt AC, 100 Amp	Heinemann	CD2-A3AW	1
E-105	Shore power receptacle	Crouse Hinds	NPQ1038	1
E-105	Shore power plug	Crouse Hinds	NPR10367	1
E-106	Electronic Current-Regulated Power Supply with 115 volt, 50/60 Hz input,	Carlisle and Finch Co.	CF-2PS115	1
E-106	Master Control Station	Carlisle and Finch Co.	CF-C4-2	1
E-106	Slave Control Station	Carlisle and Finch Co.	CF-C4E2M-1	1
E-106	200 Watt Xenon Lamp	Carlisle and Finch Co.	CF-10200	1
E-106	600Watt Inverter 24VDC	Carlisle and Finch Co.	CF-XP600	1
E-106	Plug and Cable Assembly – 20’ of cable	Carlisle and Finch Co.	14164X	1
E-106	Dummy Plug Assembly	Carlisle and Finch Co.	14165X-2	1
E-106	Weatherproof Control	Carlisle and Finch Co.	C4E2M	1
E-108	Fuel Level Gauge. 24VDC	Forster Instruments Inc.	A2C53412990-S	1
E-108	Fuel Sending Unit	Forster Instruments Inc.	224-260 (23.6” Long)	1
E-109	Step Lights	Pauluhn	827A	10
E-116	NMEA2000 to NMEA0183 Gateway	TBD	TBD	3
E-116	NMEA2000 to USB Gateway	TBD	TBD	1
E-117	Satellite Compass	Simrad	MX575D (000-11644-001)	1
E-117	Serial to NMEA2000 Adapter	Simrad	000-10941-001	1
E-118	AIS Transponder	SAAB	7000-118-540	1
E-118	Control and Display Unit	SAAB	7000-118-530	1
E-118	AIS Junction Box	SAAB	7000-118-120	1
E-118	R5 Power Cable	SAAB	7000-118-077	2
E-118	R5 DSUB-DSB Signal cable	SAAB	7000-118-286	2

## Appendix D – Parts List

E-118	Ethernet Cable	SAAB	7000-000-525	2
E-118	R5 DGNSS Sensor	SAAB	7000-118-771	1
E-118	DGNSS Antenna	SAAB	7000-000-555	1
E-118	Combined GPS/AIS Antenna	SAAB	7000-000-435	1
E-119	Transducer with stainless steel housing	Airmar	SS175M-20	1
E-120	Transducer	Airmar	UDST800	1
E-120	Transducer Housing	Airmar	SS617V	1
E-121	Autopilot hydraulic steering pump drive unit	TBD	TBD	1
E-122	Master Station	David Clark	4400G-01	1
E-122	Master Station Power cord 20FT	David Clark	40892G-20	1
E-122	Communication Headset	David Clark	TBD	4
E-122	Belt Station Smart VOX Model	David Clark	U9110-BSW	4
E-122	LI Polymer Battery	David Clark	40668G-90	8
E-122	Wireless Gateway	David Clark	U9120-W4	1
E-122	Battery Charger A99 14GCR	David Clark	41034G-02	1
E-122	Charger Power Cord 110VAC	David Clark	41090G-14	1
E-122	Ethernet Cable, Heavy Duty	David Clark	09271P-58	100FT
E-122	RJ45 IP-68 Connector	David Clark	13199P-66	4
E-122	Dual Radio with Aux card	David Clark	4403G-02	2
E-122	Radio Interface Cable	David Clark	40892G-20	4
E-122	Auxiliary Interface cable	David Clark	C91-20AX	4
E-122	Remote Antenna Kit	David Clark	40668G-96	1
E-122	Cell Phone Plug-in adapter	David Clark	TBD	1
E-123	VHF Radio	Icom	IC-M506 PLUS or approved equivalent.	1
E-123	Control Microphone for VHF Radio	Icom	HM-195	1
E-123	Black Box VHF Radio including Microphone	Icom	IC-M400BB Including HM-195	1
E-123	VHF Antenna	Sinclair Technologies	SC225M	3
E-124	MF HF Radio including: Speaker Microphone control unit	Icom	IC-M802 including: Icom HM-135 Icom SP-24	1
	MF HF Antenna Tuning Unit	Icom	AT-140	1
E-124	MFHF TX Antenna	Shakespeare	390	1
E-124	Antenna Mounting Kit	Shakespeare	410-R	1



## Appendix D – Parts List

E-124	MFHF DSC Antenna	Polaris Electronics	A159 (62.044)	1
E-125	Loudhailer Control Unit	Furuno	LH-5000	1
E-125	Intercom Speaker	Furuno	ISP-5000	4
E-125	Speaker Horn	DNH	HP-30(T)	1
E-126	Hammond Audio Transformer 1:1 4W	Hammond	117F4	1
E-126	Exciter Type Speaker 4 OHM 105DB 20W	PUI Audio	ASX10104-SPD-R	1
E-126	Audio Amp, 18 Watt 24 VDC	RDL	FP-PA18	1
E-126	Würth Elektronik Ferrite Core 93 ohm	Würth Elektronik	74271308	1
E-129	Weather Station	Airmar	220WX	1
E-130	Cellular Booster	Smoothtalker	BBCX665gaa	1
E-130	Cellular Indoor Antenna	Smoothtalker	SEMDP1NL	1
E-130	Cellular Power supply (12Vdc)	Smoothtalker	DCH6i	1
E-130	Cellular Outdoor Antenna	SureCall	SC-288W	1
E-131	Navtex Display	Furuno	NX-700B	1
E-131	Navtex Receiver	Furuno	NX-7001	1
E-131	Navtex Antenna	Furuno	NX-7H	1