

# GENERAL APPLICATIONS

## For BEVERAGE COOLERS

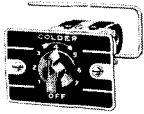

**Differential: 8°F Min., 13.5°F Max.**  
**16°F Lowest CUT-OUT. 50°F Highest CUT-IN.**  
 2<sup>3</sup>/<sub>16</sub>" mounting hole centers.  
 Cat. 49610-1 dial plate.  
 48" cap. tube, no bulb.  
**FACTORY SETTING:**

	CUT-OUT	CUT-IN
<b>Cold</b> .....	30°F	38°F
<b>Warm</b> .....	.....	42°F

(A30-262 is an adaptable replacement.)

**A10-1502**



**Differential: 6°F Min., 18°F Max.**  
**+20°F Lowest CUT-OUT. 55°F Highest CUT-IN.**  
 2<sup>1</sup>/<sub>16</sub>" to 4<sup>1</sup>/<sub>8</sub>" adjustable mounting bracket holes.  
 Cat. 50191-2 dial plate with 2 sets of holes.  
 76" cap. tube, no bulb, Cat. 32081-1.  
**FACTORY SETTING:**

	CUT-OUT	CUT-IN
<b>Cold</b> .....	36°F	.....
<b>Normal</b> .....	38°F	44°F
<b>Warm</b> .....	.....	49°F

(A30-262 is an adaptable replacement.)

**RJS-3163**

## Constant Cut-in type control.

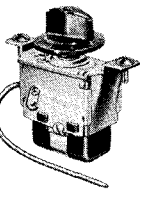

**19°F Lowest CUT-OUT, variable.**  
**35°F Highest CUT-OUT, variable.**  
**45°F Highest CUT-IN, constant.**  
 2<sup>3</sup>/<sub>16</sub>" mounting hole centers.  
 2 quick-connect type terminals.  
 Parts package contents: 2 mounting screws, 1 terminal cover, 1 large dial knob and 2 slip-on terminal adapters.  
 76" cap. tube, no bulb.  
**FACTORY SETTING:**

	CUT-OUT	CONSTANT CUT-IN
<b>Cold</b> .....	19°F	39°F
<b>Normal</b> .....	24°F	39°F
<b>Warm</b> .....	29°F	39°F

**A12-1560**

## For FREEZER CABINETS

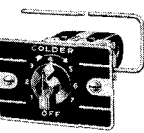

**Differential: 8°F Min., 14°F Max.**  
**-22°F Lowest CUT-OUT. 22.5°F Highest CUT-IN.**  
 2<sup>3</sup>/<sub>16</sub>" mounting hole centers.  
 Cat. 49610-1 dial plate.  
 Cat. 15909 dial knob.  
 48" cap. tube, no bulb.  
**FACTORY SETTING:**

	CUT-OUT	CUT-IN
<b>Cold</b> .....	-11°F	.....
<b>Normal</b> .....	-5°F	5°F
<b>Warm</b> .....	.....	12°F

(A30-301 is an adaptable replacement.)

**A10-2502**

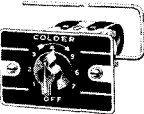

Specifications are the same as A10-2502 EXCEPT:  
 76" cap. tube, no bulb.  
**FACTORY SETTING:**

	CUT-OUT	CUT-IN
<b>Cold</b> .....	-15.5°F	.....
<b>Normal</b> .....	-13°F	4°F
<b>Warm</b> .....	.....	7.5°F

(A30-304 is an adaptable replacement.)

**A10-2571**

## With Signal Circuit

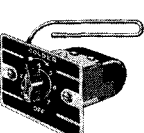

**Differential: 8°F Min., 14°F Max.**  
**-22°F Lowest CUT-OUT.**  
**22.5°F Highest CUT-IN.**  
 2<sup>3</sup>/<sub>16</sub>" mounting hole centers.  
 Cat. 49610-1 dial plate.  
 Cat. 15909 dial knob.  
 48" cap. tube, no bulb.  
**FACTORY SETTING:**

	CUT-OUT	CUT-IN
<b>Cold</b> .....	-11°F	.....
<b>Normal</b> .....	-5°F	5°F
<b>Warm</b> .....	.....	12°F

**Signal Circuit contacts make 8° to 12° ABOVE "Normal Cut-in".**

**A30-2538**

**RJS-3110**

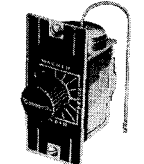

**Differential: 9°F Min., 17°F Max.**  
**-29°F Lowest CUT-OUT. 30°F Highest CUT-IN.**  
 2<sup>1</sup>/<sub>16</sub>" to 4<sup>1</sup>/<sub>8</sub>" adjustable mounting bracket holes.  
 Cat. 14576 dial plate.  
 76" cap. tube, no bulb, Cat. 32081-51.  
**FACTORY SETTING:**

	CUT-OUT	CUT-IN
<b>Cold</b> .....	-14.5°F	.....
<b>Normal</b> .....	-9°F	0°F
<b>Warm</b> .....	.....	14.5°F

**RJS-3199**

Specifications are the same as RJS-3110 EXCEPT:  
 76" cap. tube, 3/8" dia. solid bulb, Cat. 32086-43.  
 (A30-305 is an adaptable replacement.)

## For ICE CREAM CABINETS



**Differential: 7.5°F Min., 12.5°F Max.**  
**-9°F Lowest CUT-OUT.**  
**32°F Highest CUT-IN.**  
 2<sup>3</sup>/<sub>16</sub>" mounting hole centers.  
 Cat. 49610-1 dial plate.  
 48" cap. tube, no bulb.  
**FACTORY SETTING:**

	CUT-OUT	CUT-IN
<b>Cold</b> .....	-9°F	.....
<b>Normal</b> .....	0°F	10°F
<b>Warm</b> .....	.....	18°F

(A30-301 is an adaptable replacement.)

**A10-1503**

## For HOUSEHOLD REFRIGERATORS



**Differential: 10.5°F Min., 15°F Max.**  
**-4°F Lowest CUT-OUT.**  
**52°F Highest CUT-IN.**  
 2<sup>3</sup>/<sub>16</sub>" mounting hole centers.  
 Cat. 50060-1 dial plate.  
 Cat. 15909 dial knob.  
 25" cap. tube, no bulb.  
**FACTORY SETTING:**

	CUT-OUT	CUT-IN
<b>Cold</b> .....	5.5°F	.....
<b>Normal</b> .....	10°F	25°F
<b>Defrost</b> .....	.....	43°F

(A30-182 is an adaptable replacement.)

**A10-518**

**A10-918**

Specifications are the same as A10-518 EXCEPT:  
 72" cap. tube, no bulb.  
 (A30-183 is an adaptable replacement.)

Specifications are the same as A10-518 EXCEPT:  
**Differential: 12°F Min., 16°F Max.**  
**1°F Lowest CUT-OUT.**  
**50.5°F Highest CUT-IN.**

**A10-519**

**FACTORY SETTING:**

	CUT-OUT	CUT-IN
<b>Cold</b> .....	10.5°F	.....
<b>Normal</b> .....	15°F	27°F
<b>Defrost</b> .....	.....	45°F

(A30-180 is an adaptable replacement.)

**A10-919**

Specifications are the same as A10-519 EXCEPT:  
 72" cap. tube, no bulb.  
 (A30-181 is an adaptable replacement.)

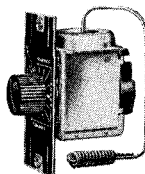

**Differential: 8°F Min., 25°F Max.**  
**-5°F Lowest CUT-OUT.**  
**55°F Highest CUT-IN.**  
 2<sup>1</sup>/<sub>16</sub>" to 4<sup>1</sup>/<sub>8</sub>" adjustable mounting bracket holes.  
 Cat. 15269 dial plate.  
 Cat. 15340 dial knob.  
 25" cap. tube, 3/8" coiled bulb, Cat. 32084-2.  
**FACTORY SETTING:**

	CUT-OUT	CUT-IN
<b>Cold</b> .....	8°F	.....
<b>Normal</b> .....	15°F	28°F
<b>Defrost</b> .....	.....	43°F

(A30-182 is an adaptable replacement.)

**RJS-830**

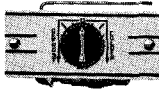

**Differential: 9°F Min., 29°F Max.**  
**-13°F Lowest CUT-OUT.**  
**65°F Highest CUT-IN.**  
 2<sup>1</sup>/<sub>16</sub>" to 4<sup>1</sup>/<sub>8</sub>" adjustable mounting bracket holes.  
 Cat. 14540 dial plate.  
 48" cap. tube, no bulb, Cat. 32081-7.  
**FACTORY SETTING:**

	CUT-OUT	CUT-IN
<b>Cold</b> .....	-1.5°F	.....
<b>Normal</b> .....	7°F	23°F
<b>Defrost</b> .....	.....	40°F

(A30-183 is an adaptable replacement.)

**RJS-1080**

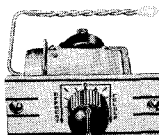

**Differential: 8°F Min., 22°F Max.**  
**-9°F Lowest CUT-OUT.**  
**62°F Highest CUT-IN.**  
 2<sup>1</sup>/<sub>16</sub>" to 4<sup>1</sup>/<sub>8</sub>" adjustable mounting bracket holes.  
 Cat. 14540 dial plate.  
 1/8" spaced prongs on insulator for light socket or connection plug.  
 38" cap. tube, 1/8" twisted bulb, Cat. 32109-1.  
**FACTORY SETTING:**

	CUT-OUT	CUT-IN
<b>Cold</b> .....	2.5°F	.....
<b>Normal</b> .....	10°F	24°F
<b>Defrost</b> .....	.....	39°F

(A30-182 is an adaptable replacement.)

**RJS-3216**

## For WATER COOLERS

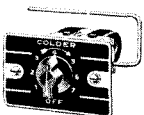

**Differential: 8°F Min., 13°F Max.**  
**18°F Lowest CUT-OUT.**  
**51°F Highest CUT-IN.**  
 2<sup>3</sup>/<sub>16</sub>" mounting hole centers.  
 Cat. 49610-1 dial plate.  
 Cat. 15909 dial knob.  
 48" cap. tube, no bulb.  
**FACTORY SETTING:**

	CUT-OUT	CUT-IN
<b>Cold</b> .....	35°F	43°F
<b>Warm</b> .....	.....	46°F

(A30-261 is an adaptable replacement.)

**A10-1501**



**Differential: 7.5°F Min., 26.5°F Max.**  
**14°F Lowest CUT-OUT.**  
**66°F Highest CUT-IN.**  
 2<sup>1</sup>/<sub>16</sub>" to 4<sup>1</sup>/<sub>8</sub>" adjustable mounting bracket holes.  
 Cat. 14576 dial plate.  
 48" cap. tube, 3/8" coiled bulb, Cat. 32084-4.  
**FACTORY SETTING:**

	CUT-OUT	CUT-IN
<b>Cold</b> .....	38°F	45.5°F
<b>Normal</b> .....	40.5°F	.....
<b>Warm</b> .....	.....	54°F

(A30-261 is an adaptable replacement.)

**RJS-3111**

R  
A  
N  
C  
O

# EXACT REPLACEMENT CONTROLS

## AMANA

1950

Freezer Models: Uprights 12, 18, 25S, 200S.  
Replaces: A10-2508, 2648, A2625.

2 $\frac{3}{8}$ " mounting hole centers.  
Cat. 15909 dial knob.  
Cat. 49610-1 dial plate.  
76" cap. tube, no bulb.

FACTORY SETTING:	CUT-OUT	CUT-IN
Cold .....	-17°F	
Normal .....	-12°F	0°F
Warm .....		14.5°F

(A30-301 is an adaptable replacement.)

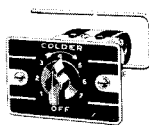

A10-2574

## BOWSER

1946, 47, 48

Medical Cabinets.  
Replaces: B-1022.

2 $\frac{3}{8}$ " mounting hole centers.  
Screw driver slotted dial shaft.  
25" cap. tube, no bulb.

FACTORY SETTING:	CUT-OUT	CUT-IN
On scribe mark .....	0°F	25°F

(A30-263 is an adaptable replacement.)

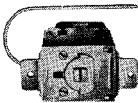

A10-1522

## CARRIER

1945 through 1949

Freezer Cabinet Model: 1405-7.  
Replaces: HH22UK-102, 104, B-111,  
B-160, A10-638.

2 $\frac{3}{8}$ " mounting hole centers.  
No OFF position.  
108" cap. tube,  $\frac{3}{8}$ " coiled bulb.

FACTORY SETTING:	CUT-OUT	CUT-IN
Cold .....	-13.5°F	
Warm .....	-8.5°F	-2.5°F

Signal circuit contacts BREAK 8° to 12° above "Warm Cut-in".

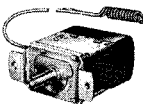

A30-2503

1948 through 1951

Freezer Cabinets.  
Replaces: HH22UK-105, 110, B-163, B-194,  
A10-2605.

2 $\frac{3}{8}$ " mounting hole centers.  
Cat. 50928-1 white dial knob.  
18" cap. tube,  $\frac{3}{8}$ " coiled bulb.

FACTORY SETTING:	CUT-OUT	CUT-IN
Cold .....	-25°F	
Warm .....	-11.5°F	-2.5°F

Signal circuit contacts BREAK 8° to 12° ABOVE "Warm Cut-in".

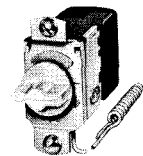

A30-2605

1952 through 1958

Ice Cube Maker Models: 26C5, 26D5, 26H5.

Replaces: HK08RA030, 012-1561  
Dual Temperature Control.

### TEMPERATURE:

CUT-IN Range: 30° to 50°F, adjustable.  
Differential: 4° to 10°F, adjustable.  
Lowest Cut-out Point: 20°F.

### HIGH PRESSURE:

CUT-OUT Range: 100 to 250 psi, adjustable.  
45 psi FIXED Differential.

Mounting bracket is omitted.  
Cat. 50156-1 dial knob on range screw.  
Power Elements: 36" cap. tube,  $\frac{1}{4}$ " SAE flared tube and nut, Cat. 32116-1, High Pressure. 76" cap. tube,  $\frac{3}{8}$ " x  $1\frac{1}{2}$ " bulb, Cat. 32086-6; Temperature.

FACTORY SETTING:	CUT-OUT	CUT-IN
Temperature .....	33.5°F	40.5°F
High Pressure .....	220 psi	175 psi

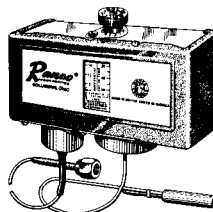

012-4008

1952 through 1958

Ice Cube Maker Models: 25C5, D3, D5,  
H3, H5 (Bin Harvest).

Replaces: HH22UK526, 015-1516 Two-Temperature Control.

CUT-OUT Range: Fixed at 38°F.  
CUT-IN Range: 40° to 85°F, adjustable.  
Mounting bracket is omitted.  
Cut-out range screw head is cut off.  
Dial knob is omitted on Cut-in range.

S.P.D.T. switch, normally closed to terminals #2 & #3, is operated by action of two power elements.

Power Elements: CUT-OUT Side:  
48" cap. tube, no bulb, Cat. 32081-7.

CUT-IN Side:  
48" cap. tube,  $\frac{3}{8}$ " x  $9\frac{1}{2}$ " bulb (cross-ambient),  
Cat. 32076-5.

FACTORY SETTING:	CUT-OUT	CUT-IN
------------------	---------	--------

CUT-OUT Side,  
terminals #2 & #3 .....38°F

CUT-IN Side,  
terminals #2 & #3 .....55°F

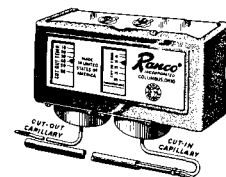

015-4351

1946

Freezer Cabinets.  
Replaces: HH22UK-101, B-129,  
31-W-124107, B-169.

2 $\frac{3}{8}$ " mounting hole centers.  
Screw driver slotted dial shaft.  
60" cap. tube, no bulb.

FACTORY SETTING:	CUT-OUT	CUT-IN
Cold .....	-7.5°F	
Scribe mark on normal .....	-2°F	4°F
Warm .....		9°F

(A30-301 is an adaptable replacement.)

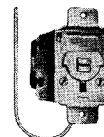

A10-2544

## COLDSPOT

1947, 1948

Household Models: B1D, B1F, B1S, B7D, B7P,  
B7S, B9D, B9F, B9S, B9D-25, B9F-25; and  
usable on A1F, A7F, A7P, A7S, A9D, A9F.

Replaces: 31762, 31372, 32373, 32374, 32376,  
32377, B-536, A10-506; and applies to  
31693, 31694, 31761, B-506, B-506-A, B-552.

2 $\frac{3}{8}$ " mounting hole centers.  
3-prong driver made for original knob.  
Cat. 57527-3 terminal cover supplied.  
27" cap. tube, no bulb.

FACTORY SETTING:	CUT-OUT	CUT-IN
No. 9 (cold) .....	-5°F	
No. 5 (normal) .....	3.5°F	15.5°F
Defrost .....		37°F

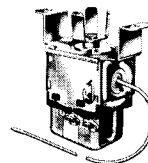

A30-506

1947, 1948

Freezer Models: 5112, 5118, 51109, 81106.  
Replaces: 36402, 101900, B-2505,  
A10-2501, B-2506.

4" mounting hole centers on a special bracket.  
Special dial shaft for original knob.  
Cat. 57527-3 terminal cover supplied.  
78" cap. tube, no bulb.

FACTORY SETTING:	CUT-OUT	CUT-IN
Cold .....	-19°F	
Warm .....	-6°F	5°F

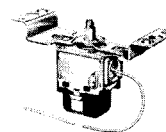

A30-3506

1953

Household Models: G9E-D1, G11E-D1.  
Replaces: 34581, 34939, 34681.

CLOCKWISE shaft rotation.  
60 minute Time Safe Period.  
115 Volts, 60 cycle motor current.  
4 Ark-les terminals.  
76" cap. tube, no bulb.

FACTORY SETTING:	CUT-OUT
Defrost termination .....	42°F

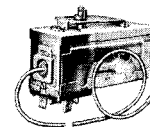

E11-1628

R  
A  
N  
C  
O

# EXACT REPLACEMENT CONTROLS

## COOLERATOR

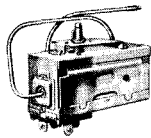

**E11-1620**

**1951, 52, 53**

Household Models: RTA-98, 119.  
Replaces: R-14328-1, -4, -5, R-14596-3,  
19433, 19434.

CLOCKWISE shaft rotation.  
45 minute Time Safe Period.  
115 Volts, 60 cycle motor current.  
4 screw type terminals.  
60" cap. tube, no bulb.

FACTORY SETTING: CUT-OUT  
Defrost termination .....50°F

## CORDLEY AND HAYES

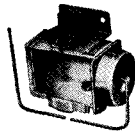

**RJ-3241**

**1940, 1941**

Water Cooler Model: T-20.  
Replaces: 62853-4, ER-32510B1,  
RJ-1064, RJ-3144.

1 1/4" mounting hole centers on angle bracket.  
38" cap. tube, no bulb.

FACTORY SETTING: CUT-OUT CUT-IN  
No. 7 (cold) .....37.5°F 48°F  
No. 1 (warm) .....54°F  
(A30-261 is an adaptable replacement.)

## CROSLY

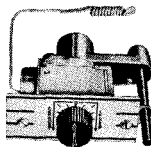

**RJ-3214**

**1937 through 1940**

Household Models: K-75, HB1-36, 41, 50, 60.  
Replaces: 19805, 82696, 82786, 82877-A,  
Tagliabue controls: R-30, 40, 3040.

3 1/4" mounting hole centers.  
LRP-690 light socket with control.  
38" cap. tube, 3/8" dia. coiled bulb.

FACTORY SETTING: CUT-OUT CUT-IN  
Cold .....6.5°F  
Normal .....14°F 24°F  
Defrost .....40°F

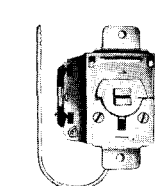

**A10-2544**

**1946 through 1949**

Freezer Models: "Frostmaster".  
Replaces: 31-W-124107 Consolidated  
Vultee, B-129, B-169.

2 3/8" mounting hole centers.  
Screw driver slotted dial shaft.  
60" cap. tube, no bulb.

FACTORY SETTING: CUT-OUT CUT-IN  
Cold .....-7.5°F  
Scribe mark on normal .....2°F 4°F  
Warm .....9°F  
(A30-301 is an adaptable replacement.)

**A10-698**

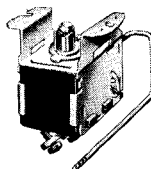

**A10-700**

**1948 through 1951**

Household models.  
Replaces: C-94521-1, A10-515.

1 1/4" mounting hole centers.  
25" cap. tube, no bulb.

FACTORY SETTING: CUT-OUT CUT-IN  
Cold .....4°F  
Normal .....10.5°F 21.5°F  
Warm .....28°F

Specifications are the same as A10-698 EXCEPT:  
Replaces: C-95169-1, -2, A10-531, A10-551;  
applies to C-94823-1, A10-520, A10-699.

31" cap. tube, no bulb.

FACTORY SETTING: CUT-OUT CUT-IN  
Cold .....-10°F  
Normal .....0°F 15°F  
Warm .....21.5°F

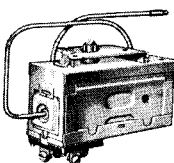

**E11-1602**

**1954**

Household Models: CAF-105, 125,  
DAF-125.  
Replaces: D-100677-1, 101416-1.

CLOCKWISE shaft rotation.  
45 minute Time Safe Period.  
115 Volts, 60 cycle motor current.  
4 screw type terminals, color coded.  
Attach original dial driver on shaft of this control.  
20 1/8" cap. tube, no bulb.

FACTORY SETTING: CUT-OUT  
Defrost termination .....56°F

**1951, 52, 53**

Household Models: CAD-10, 12, DAD-10,  
T-CAD-12, T-DAD-12, T-CAE-12, T-CAF-12.

Replaces: C & D-97921-1, D-100687-1,  
97995-4 (Paragon), 100749-1 (Hayden).

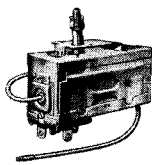

**E11-1653**

COUNTER CLOCKWISE shaft rotation.  
45 minute Time Safe Period.  
115 Volts, 60 cycle motor current.  
4 screw type terminals, color coded.  
125 1/8" cap. tube, no bulb.

FACTORY SETTING: CUT-OUT  
Defrost termination .....56°F

Specifications are the same as E11-1653 EXCEPT:

**E11-1621**

Household Model: CAE-11.  
Replaces: C & D-97921-4, D-100687-4.

CLOCKWISE shaft rotation.

**1955, 1956**

Household Models: CH-105, RFG-125,  
RFH-125, RH-11, 14, ROG-11.

Replaces: D-101778-4, 7, D-104135-1, 4, 7.

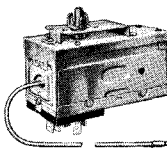

**E11-1659**

COUNTER CLOCKWISE shaft rotation.  
45 minute Time Safe Period.  
115 Volts, 60 cycle motor current.  
5 Ark-les type terminals, color coded.  
78" cap. tube, no bulb.

FACTORY SETTING: CUT-OUT  
Defrost termination .....45°F

## DEEFPREEZE

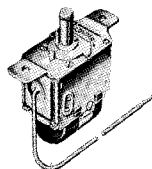

**A10-2554**

**1947 through 1950**

Freezer Models: A5, B6, B10, C5, C6, C10.  
Replaces: S-5529, S-6581, B-1045,  
A10-2500, A10-2505.

2 3/8" mounting hole centers.  
No OFF position.  
66" cap. tube, no bulb.

FACTORY SETTING: CUT-OUT CUT-IN  
Fast Freeze .....-13°F  
Warm .....-5°F 3°F  
(A30-301 is an adaptable replacement.)

**1950 through 1953**

Freezer Models: C7, C13, C17, C135,  
C147, C158, C175, C187, C228.  
Replaces: 10029, 10261, A10-2559,  
A10-2560, A10-2812.

2 3/8" mounting hole centers.  
No OFF position.  
66" cap. tube, no bulb.

FACTORY SETTING: CUT-OUT CUT-IN  
Cold .....-15°F  
Warm .....-8°F 6°F

**A30-2812**

Signal circuit contacts MAKE 8° to 12°F ABOVE  
"Warm Cut-in".

**1952, 1953**

Household Model.  
Replaces: 50966.

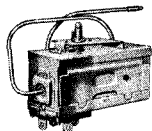

**E11-1622**

CLOCKWISE shaft rotation.  
45 minute Time Safe Period.  
115 Volts, 60 cycle motor current.  
4 screw type terminals.  
38" cap. tube, no bulb.

FACTORY SETTING: CUT-OUT  
Defrost termination .....45°F



**REPLACEMENT  
REFERENCE MANUAL  
No. 1660**

No. 1660 lists over 5,000 Ranco  
Replacement Control applications—  
most complete line in the  
industry.

R  
A  
N  
C  
O

# EXACT REPLACEMENT CONTROLS

1950, 51, 52

Window Air Conditioners.

Replaces: 11-21-283B, A10-1513, A10-1599.  
"Mitchell" & "Coldspot" models: M343, 1003,  
2007, 2008, 2009, 2010, 2083, 2303, 12083.

1 $\frac{7}{8}$ " mounting hole centers.  
Cat. 15515 dial knob with set screw supplied.  
1 $\frac{3}{8}$ " extended dial shaft with a flat.  
18" cap. tube, no bulb.

FACTORY SETTING: CUT-OUT CUT-IN  
Cold .....56°F 61°F  
Warm .....80°F  
(A30-450 is an adaptable replacement.)

FEDDERS

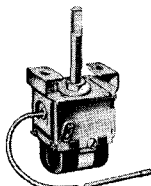

A10-1586

1942 through 1947  
Household Models: CD7, CDI-7, CDI-9,  
CDM-7, CPD7, 9, 13, CPDI-7, 9,  
CPDM-7, 9, D7, D9, DI-7, 9, DPI-7,  
M7, M17, MP7, S7, SI-7.

Replaces: 5417232, 5417237 (unit package).

3 $\frac{1}{4}$ " mounting hole centers.  
Dial knob in Frigidaire Unit package fits dial shaft.  
66" cap. tube with plastic sleeve, no bulb.

FACTORY SETTING: CUT-OUT CUT-IN  
No. 7 (cold) .....0°F  
No. 1 (normal) .....12°F 28°F  
Defrost .....43°F

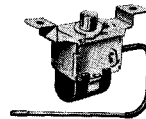

A10-668

1952, 1953

Household Models.

Replaces: R-50166, R-50194.

CLOCKWISE shaft rotation.  
45 minute Time Safe Period.  
115 Volts, 60 cycle motor current.  
4 Ark-les type terminals.  
31" cap. tube, no bulb.

FACTORY SETTING: CUT-OUT  
Defrost termination .....63°F

FRANKLIN

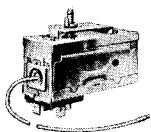

E11-1623

1948 through 1951

Household Models: AJ-6, AL-60, MJ-6, 7, 9,  
11, ML-60, 77, 77P, 93, 93P, 115, 171, SJ-6.

Replaces: 5851025, 5890518, 5850755.

1 $\frac{3}{8}$ " mounting hole centers.  
Original dial knob fits dial shaft.  
66" cap. tube with plastic sleeve, no bulb.

FACTORY SETTING: CUT-OUT CUT-IN  
No. 7 (cold) .....-0.5°F  
No. 1 (normal) .....12°F 28°F  
Defrost .....42°F

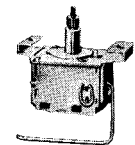

A10-701

1933 through 1940

Household "Deluxe", "Imperial",  
"Master", "Special" models.

Replaces: 1124128, 1124376, 1125556,  
1125619, 5417274, 5417286, 5417287,  
5417288, 5417362, 5417364, 5417371,  
5850825.

On Montgomery-Ward: 1125550, 1125558,  
1128654, (Used with dial plate numbers:  
5403325, 5404377, 5404469, 629976, 629977,  
630967; RJS-3280.

3 $\frac{1}{4}$ " mounting hole centers.  
Cat. 51773-2 dial plate, 4 $\frac{7}{8}$ " spaced holes.  
Cat. 52003-1 ADAPTER BRACKET, not supplied,  
to be ordered separately for certain mountings.  
31" cap. tube,  $\frac{3}{8}$ " dia. twisted bulb.

FACTORY SETTING: CUT-OUT CUT-IN  
Cold .....4.5°F  
Normal .....12°F 28°F  
Defrost .....48°F

(A30-182 is an adaptable replacement.)

FRIGIDAIRE

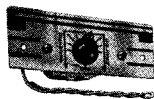

A10-643

1952 through 1958

Household Models: S-8, SA-8, D-11, D-13.

Replaces: 5890766, EM-17344.

1 $\frac{3}{8}$ " mounting hole centers.  
Original dial knob fits dial shaft.  
Dial shaft end is threaded above the hex head.  
Use original BULB SPACER with replacement.  
72" cap. tube with plastic sleeve,  $\frac{3}{8}$ " dia. twisted  
bulb.

FACTORY SETTING: CUT-OUT CUT-IN  
No. 3 (cold) .....-8°F  
No. 1 (normal) .....2°F 18°F  
Defrost .....44°F

Marks on  
Dial Knob



A10-886

1936

Household Models: DRS5-36, DRS6-36.

Replaces: 1124127, 1125619.

4 $\frac{1}{8}$ " mounting hole centers.  
Cat. 15436 dial plate, specially formed.  
Cat. 15340 dial knob.  
31" cap. tube,  $\frac{3}{8}$ " dia. twisted bulb.

FACTORY SETTING: CUT-OUT CUT-IN  
Cold .....10°F  
Normal .....17°F 29°F  
Defrost .....42°F

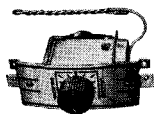

RJS-831

1953 through 1958

Household Models: Deluxe FD-104, IR-90, 106,  
IS-90, IS-106, Imperial FI-122.

Replaces: 5890720 Constant Cut-in type  
control.

1 $\frac{3}{8}$ " mounting hole centers.  
Original dial knob fits dial shaft.  
Dial shaft end is threaded above the serrations.  
Use original BULB SPACER with replacement.  
48" cap. tube with plastic sleeve, no bulb.

FACTORY SETTING: CUT-OUT CUT-IN  
No. 3 (cold) .....-7°F 36°F  
No. 1 (normal) .....-4.5°F 36°F  
No. B (warm) .....-1.5°F 36°F

A26-110

Marks on  
Dial Knob

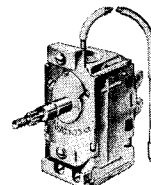
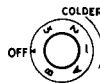

A26-111

1941

Household Models: C6, C9, CD6, CDM9, CP6,  
CPD-6, CPD9-41, CPD13-41, DP-7, L6, L8,  
LP6, LS6, M6, MP6.

Replaces: 1128793 mounted in bottom  
compartment.

3 $\frac{1}{4}$ " mounting hole centers.  
Original dial knob fits dial shaft.  
108" cap. tube with plastic sleeve, no bulb.

FACTORY SETTING: CUT-OUT CUT-IN  
No. 7 (cold) .....0°F  
No. 1 (normal) .....12°F 28°F  
Defrost .....43°F

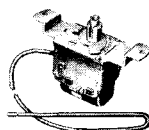

A10-772

1948 through 1951

Household Models: DJ-11, DL-105,

DM90, DM-90P, 107, 107P.

Replaces: 5850853, 5850983.

1 $\frac{3}{8}$ " mounting hole centers.  
Original dial knob fits dial shaft.  
31" cap. tube,  $\frac{3}{8}$ " dia. twisted bulb.

FACTORY SETTING: CUT-OUT CUT-IN  
No. 3 (cold) .....-2.5°F  
Normal .....2°F 18°F  
Defrost .....43°F

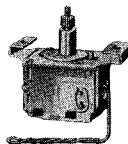

A10-667

1936 through 1947  
Ice Cream Cabinets (a.c. rating ONLY).  
Replaces: 1124436, 1125604, 1127628,  
1127632, 1128661, 1128663,  
1140840, 5850637.

3 $\frac{1}{4}$ " mounting hole centers.  
Dial and settings match original dial plate.  
Cat. 15909 dial knob.  
76" cap. tube,  $\frac{3}{8}$ " dia. solid bulb.

FACTORY SETTING: CUT-OUT CUT-IN  
No. 6 (cold) .....-12°F 5°F  
No. 5 .....-5.5°F 6.5°F  
No. 3 $\frac{1}{2}$  (normal) .....0°F 12°F  
No. 2 .....5.5°F 17°F  
No. 1 (warm) .....14°F 24.5°F

Marks on  
Dial Plate

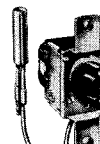
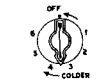

A10-1558

R  
A  
N  
C  
O

# EXACT REPLACEMENT CONTROLS

## FRIGIDAIRE

Marks on Dial Plate

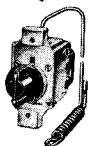

**A10-1584**

1948 through 1951

Ice Cream Cabinets (a.c. rating ONLY).  
Replaces: 5417426, 5417469.

1 1/8" mounting hole centers.  
Dial and settings match original dial plate.  
Cat. 15909 dial knob.  
76" cap. tube, 3/8" dia. coiled bulb.

FACTORY SETTING:	CUT-OUT	CUT-IN
No. 4 (cold)	-13.5°F	1°F
No. 3	-4.5°F	10°F
No. 2 1/2 (normal)	0°F	14°F
No. 2	6.5°F	20°F
No. 1 (warm)	16°F	28°F

## GENERAL ELECTRIC

1938 through 1951

Household Model: BY4-A2.  
Replaces: M1A-163, 180, 199, 203,  
204, 232, 233, 270, WR9X4, 5, 17,  
A10-697 (Ranco).

2 3/8" mounting hole centers.  
Cat. 15909 dial knob.  
31" cap. tube, 3/8" dia. twisted bulb.

FACTORY SETTING:	CUT-OUT	CUT-IN
Cold	5°F	
Normal	12°F	24°F
Defrost		44°F

(A30-180 is an adaptable replacement.)

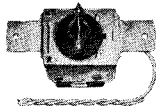

**A10-670**

1941, 1942

Household Models.  
Replaces: CR-1057-B21D-G59, WR9X11,  
WR9X54.

2 3/8" mounting hole centers.  
Cat. 15340 dial knob.  
28" cap. tube, no bulb.

FACTORY SETTING:	CUT-OUT	CUT-IN
Cold	-3°F	
Normal	4.5°F	17.5°F
Warm		26.5°F

(A30-180 is an adaptable replacement.)

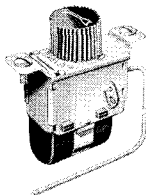

**A10-669**

1941, 1942

Household Models.  
Replaces: WR9X1A, 11, CR-1057-B21E-CR53,  
B21D-C53.

2 3/8" mounting hole centers.  
Cat. 15340 dial knob.  
22" cap. tube, 3/8" dia. twisted bulb.

FACTORY SETTING:	CUT-OUT	CUT-IN
Cold	-3.5°F	
Normal	4.5°F	16°F
Defrost		41°F

(A30-180 is an adaptable replacement.)

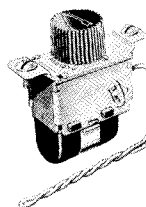

**A10-696**

Specifications are the same as A10-696 EXCEPT:

1942 through 1951

"HOTPOINT" Household Models.  
Replaces: M1A-250, 258, WR9X9, WR9X20.  
28" cap. tube, 3/8" dia. twisted bulb.

FACTORY SETTING:	CUT-OUT	CUT-IN
Cold	17.5°F	
Normal	22°F	29°F
Defrost		43°F

(A30-180 is an adaptable replacement.)

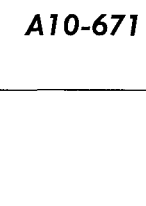

**A10-671**

Constant Cut-In type control

Defrosts Household Refrigerator each cycle.  
Replaces: WR9X111, 113, 114, 115, 120, 125,  
126, 127, 128, 137, 145, 156, 157, 163, 169.

Mounting bracket adjustable to 1/8" height from control, and adjustable hole centers from 1 1/2" to 3 3/8".

Parts package contents: 1 dial shaft assembly fits G.E. knob, 2 each mounting clips and screws, 2 terminal adapters.

OFF position provided on cam.  
54" cap. tube, no bulb.

FACTORY SETTING:	CUT-OUT	CONSTANT CUT-IN
Cold	-16°F	38°F
Normal	-4°F	38°F
Warm	7.5°F	38°F

**A42-191**

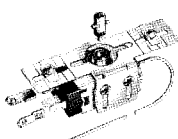

## GENERAL ELECTRIC

1942 through 1951

Freezer Models: AA, AB, AC, FH83,  
FH103, and "HOTPOINT".

Replaces: WR9X8, CR-1057-B21, G54.

2 3/8" mounting hole centers.  
Cat. 15340 dial knob.  
96" cap. tube, 3/8" dia. twisted bulb.

FACTORY SETTING:	CUT-OUT	CUT-IN
Cold	-6°F	
Normal	0°F	9.5°F
Warm		15.5°F

Specifications are the same as A10-694 EXCEPT:

1946 through 1950

Freezer Models.

Replaces: WR9X3, 10, 18.

28" cap. tube, 3/8" dia. twisted bulb.

FACTORY SETTING:	CUT-OUT	CUT-IN
Cold	-23°F	
Normal	-15°F	-2°F
Warm		6°F

(A30-304 is an adaptable replacement.)

**A10-694**

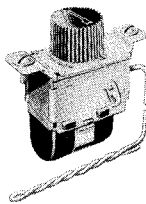

**A10-2607**

1940, 1941

Water Coolers.

Replaces: M4B-356, RJ-1064.

1 1/4" mounting hole centers on angle bracket.  
Cat. 16289 dial knob.  
38" cap. tube, no bulb.

FACTORY SETTING:	CUT-OUT	CUT-IN
No. 7 (cold)	37.5°F	48°F
No. 4		51°F
No. 1		54°F

(A30-261 is an adaptable replacement.)

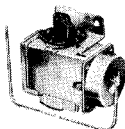

**RJ-3241**

## GIBSON

1952, 1953

Household Models: G-692, A, C, G-974, 982,  
E, G-1062, 1072, 1074, 1082, 1084, GA-973,  
1193, GAB-973, GAC-973, 1193, TA-1053,  
TD-1052, 1082, TD-1094A.

Replaces: X-33866, 36161, 68449, 35874 (Hayden); E. Roy Industries: B-15441, 15487.

CLOCKWISE shaft rotation.  
45 minute Time Safe Period.  
115 Volts, 60 cycle motor current.  
4 screw type terminals.  
48" cap. tube, no bulb.

FACTORY SETTING:	CUT-OUT
Defrost termination	45°F

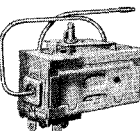

**E11-1624**

## HALSEY TAYLOR

1946 through 1950

Water Coolers.

Replaces: B-1028.

2 3/8" mounting hole centers.  
Screw driver slotted dial shaft.  
48" cap. tube, no bulb.

FACTORY SETTING:	CUT-OUT	CUT-IN
Scribe mark on normal	47°F	53°F

(A30-261 is an adaptable replacement.)

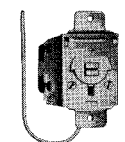

**A10-1518**

## HARDER

1945 through 1948

Freezer Models.

Replaces: B-208.

2 3/8" mounting hole centers.  
Cat. 49610-1 dial plate.  
Cat. 15909 dial knob.  
48" cap. tube, no bulb.

FACTORY SETTING:	CUT-OUT	CUT-IN
Cold	-14.5°F	
Normal	-10°F	0°F
Warm		6.5°F

(A30-301 is an adaptable replacement.)



**A10-2572**

# EXACT REPLACEMENT CONTROLS

## HARDER

1945 through 1950

Freezer Models: HC-12C, 18C.  
Replaces: B-122, 171, A10-2548, A10-2578.  
2 7/8" mounting hole centers.  
Cat. 15909 dial knob.  
76" cap. tube, no bulb.

FACTORY SETTING:	CUT-OUT	CUT-IN
Cold .....	-5°F	
Normal .....	1°F	7°F
Warm .....		13°F

Signal circuit contacts MAKE 8° to 12° ABOVE "Normal Cut-in".

**A30-2578**

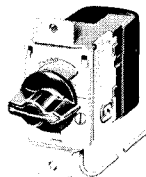

## IDEAL DISPENSER

1949 through 1953

Beverage Coolers.  
Replaces: A10-1512, 1555, 1576, A12-1614,  
Constant Cut-in type control.  
2 7/8" mounting hole centers.  
Cat. 50839-1 dial knob.  
38" cap. tube, 3/8" dia. coiled bulb.

FACTORY SETTING:	CUT-OUT	CUT-IN
Cold .....	9°F	38°F
Warm .....	22°F	38°F

(A42-188 is an adaptable replacement.)

**A12-1506**

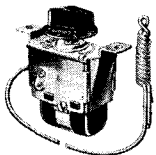

## INTERNATIONAL HARVESTER

1949, 50, 51

Household Models: U87, 89, 95, UA87, 95.  
Replaces: 412414R-91, -92, A10-542.

2 7/8" length of mounting bracket. Mounting holes are in each turned down tab.  
76" cap. tube, no bulb.

FACTORY SETTING:	CUT-OUT	CUT-IN
Cold .....	-2°F	
Normal .....	4°F	22°F
Defrost .....		46°F

**A10-672**

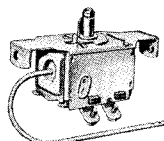

## KELVINATOR

1941 through 1949

Household Models: C7, CD7, CS7, D6, M6, M7, M8, M9 (moist master), MM9, P56, R6, S6, S8, SS6.

Replaces: 1101373-B, 1101374, 1101479, 1101506, 1101602, 1101601, 1101800, RJ-1044, RJ-1045, RJ-3017, RJ-3044, RJ-3246, RJ-3247, B-501, B-502, B-520, B-553, B-554, B-555.

No range adjustment.  
Differential: 12.5°F Min., 20.5°F Max.  
-1°F Lowest CUT-OUT on dial.  
44°F Highest CUT-IN on dial.

Mounting bracket adjustable to 7/8" height from control and hole centers from 1 3/8" to 3 3/8".

Parts package contents: 1 special mounting bracket with 3 1/8" spaced mounting hole centers, 1 adjustable mounting bracket, 1 driver, 1 dial shaft, 2 each mounting clips, screws, mounting screws, & terminal adapters.

OFF position provided on cam.  
33" cap. tube, no bulb.

FACTORY SETTING:	CUT-OUT	CUT-IN
Cold .....	-1°F	
Normal .....	8°F	25.5°F
Defrost .....		44°F

**A30-186**

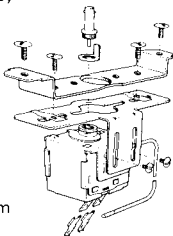

1937 through 1940

Household Models: P5, 6, 7, S6, 8, SS6.  
Replaces: 1122982, 1122983, 1123598, 1124541.

2 1/8" to 4 1/8" adjustable mounting bracket.  
Cat. 14540 dial plate.  
48" cap. tube, 3/8" dia. twisted bub.

FACTORY SETTING:	CUT-OUT	CUT-IN
Cold .....	6°F	
Normal .....	14°F	28°F
Defrost .....		47°F

**RJS-3169**

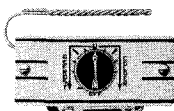

1946 through 1953

Beverage Coolers.  
Replaces: 1117310, 1117538.

3 3/8" mounting hole centers.  
Cat. 15909 dial knob supplied.  
25" cap. tube, 3/8" dia. solid bulb.

FACTORY SETTING:	CUT-OUT	CUT-IN
Cold .....	29°F	35°F
Warm .....		45.5°F

(A30-261 is an adaptable replacement.)

**A10-1656**

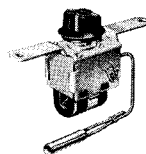

## KELVINATOR

1951, 52, 53

Hot Gas Defrost Household Models:  
HM-AD, HM-MA, EA.

Replaces: 1157708, 1175067.

CLOCKWISE shaft rotation.  
45 minute Time Safe Period.  
115 Volts, 60 cycle motor current.  
3 screw type terminals.  
18" cap. tube, no bulb.

FACTORY SETTING:	CUT-OUT
Defrost termination .....	42°F

Specifications are the same as E13-1625 EXCEPT:

Household Models: KA, MA.

Replaces: 1157334, 1157709, 1176906-B.

3 Ark-les type terminals.

**E13-1626**

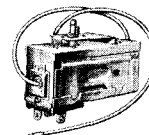

## LIPMAN

1950 through 1954

Hot Gas Defrosting of Automatic  
Ice Maker Machine

Replaces: B-12529, 011-1762.

SPST Switch Action (Basic is SPDT)

Cat. 16859 mounting bracket.  
Cat. 15574 strip clamp package.  
72" cap. tube, 1/2" dia. special bulb, Cat. 52266-1.

FACTORY SETTING:	CUT-OUT	CUT-IN
(#1 terminal removed)	(over)	(under)
Terminals #2 & #3 .....	32°F	32°F

**021-100**



## NORGE

1946 through 1949

Household Models.

Replaces: 10-1545, 2367, 4154, 4155.

2 1/8" mounting hole centers.  
Original dial knob fits special shaft.  
Screw type terminals.  
36" cap. tube by 1/8" O.D., no bulb.

FACTORY SETTING:	CUT-OUT	CUT-IN
No. 9 (cold) .....	0°F	
No. 1 (normal) .....	16.5°F	31.5°F
Defrost .....		40°F

**A10-521**

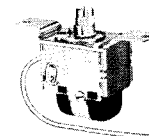

## PHILCO

1949, 50, 51

Household Models: E703, 704, 903, 904, 905, 906, 1102, 1103, 1104, 1107, F818, 1018, 1218, 1312, 1315.

Replaces: 5530-79, 81, 90, 95, 97.

2 3/8" mounting hole centers.  
Original knob fits special dial shaft.  
31" cap. tube, no bulb.

FACTORY SETTING:	CUT-OUT	CUT-IN
No. 5 (cold) .....	-18.5°F	
No. 2 (normal) .....	3°F	18°F
No. 1 (warm) .....		25°F

**A10-710**

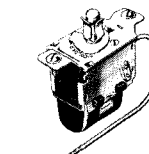

1941 through 1949

Household Models: A-411, 620, 621, 622, 721, 731, 741, 750, 751, 752, 931, 950, 951, C-680, 780, 883, 885, 887, 1085, 1087, C-1100, L6, LF8, LH6, 8, LHP6.

Replaces: 5530-36, 37, 42, 46, 47, 54\*, 55A\*, 56, 57, 62\*, 63\*, 68\*, 69\*, 70\*, 71\*, 74\*, 75\*, A10-504\*, B-500, B-504, B-522\*, B-523, B-557, B-558, B-559\*, B-560, M2-1122.

Range adjustment.  
Differential: 12°F Min., 17°F Max.  
-5°F Lowest CUT-OUT on dial.  
45.5°F Highest CUT-IN on dial.

2 3/8" mounting hole centers.  
Original knob fits special dial shaft.  
Screw type terminals tapped 8-32.  
Cat. 57527-3 terminal cover supplied.  
39" cap. tube, no bulb.

FACTORY SETTING:	CUT-OUT	CUT-IN
Cold .....	-5°F	
Normal* .....	0°F	12°F
Defrost .....		37.5°F

\*NOTE: Setting is exact for control numbers marked.

**A30-525**

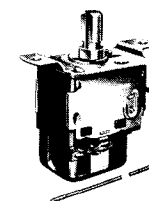

R  
A  
N  
C  
O

# EXACT REPLACEMENT CONTROLS

## REVCO

**A30-2593**

**1945 through 1951**  
 "Chill-Chest" Freezer Cabinet.  
 Replaces: A10-2543, A10-2591.  
 2 $\frac{3}{8}$ " mounting hole centers.  
 Cat. 50839-1 dial knob with OFF position.  
 54" cap. tube, no bulb.  
 FACTORY SETTING: CUT-OUT CUT-IN  
 Cold .....-25°F .....  
 Warm .....-9°F ..... 0°F  
 Signal circuit contacts MAKE 13° ABOVE "Warm Cut-in"



**A30-2594**

**1950, 1951**  
 Freezer Cabinets.  
 Replaces: A10-2546, A10-2591, A10-2594, B-4296.  
 2 $\frac{3}{8}$ " mounting hole centers.  
 Cat. 50839-2 dial knob.  
 No OFF position.  
 54" cap. tube, no bulb.  
 FACTORY SETTING: CUT-OUT CUT-IN  
 Cold .....-32°F .....  
 Warm .....-9°F ..... 0°F  
 Signal circuit contacts BREAK 13° ABOVE "Warm Cut-in".

## SUNROC

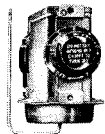

**RJS-3219**

**1946, 1947**  
 Water Coolers.  
 Replaces: B-1034.  
 2 $\frac{1}{8}$ " mounting hole centers.  
 Cat. 50903-1 dial knob supplied.  
 48" cap. tube, no bulb.  
 FACTORY SETTING: CUT-OUT CUT-IN  
 No. 1 (cold) .....43°F ..... 47°F  
 No. 7 (warm) ..... ..... 55°F  
 (A30-261 is an adaptable replacement.)

## TEKNI-CRAFT

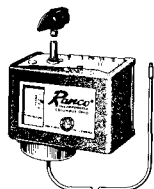

**025-100**

**1947 through 1955**  
 Soft Ice Cream Dispenser Models: 6F, 10F.  
 Replaces: 6128, G-27, 010-1494.  
 FIXED Differential.  
 Cat. 16859 mounting bracket (not shown).  
 Cat. 15515 dial knob with a set screw.  
 Dial shaft extends 3 $\frac{1}{8}$ " (range screw).  
 Pilot Duty: 345VA at 230 Volts a.c., SPDT Switch.  
 48" cap. tube, no bulb, Cat. 32081-56.  
 FACTORY SETTING: CUT-OUT CUT-IN  
 #2 & #3 terminals .....23.5°F ..... 25°F on Rise

## UNIFLOW

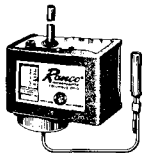

**010-1823**

**1939 through 1948**  
 Beer Coolers.  
 Replaces: G2-1261, 010-1420, 010-1498.  
 CUT-IN Range: 0° to 55°F, adjustable.  
 FIXED Differential.  
 Lowest Cut-out Point: -2°F.  
 No mounting bracket supplied.  
 Extension shaft on range is 3 $\frac{1}{8}$ " long.  
 25" cap. tube, 3/8" x 1 $\frac{1}{2}$ " solid bulb, Cat. 32086-1.  
 FACTORY SETTING: CUT-OUT CUT-IN  
 ..... 38.5°F ..... 40.5°F

## VENDO

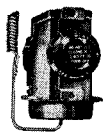

**RJS-3221**

**1947, 1948**  
 Bottle Vending Machines.  
 Replaces: B-1038, B-1058, H-49956A.  
 2 $\frac{3}{8}$ " mounting hole centers.  
 Cat. 50903-1 dial knob supplied.  
 48" cap. tube, 3/8" coiled bulb.  
 FACTORY SETTING: CUT-OUT CUT-IN  
 No. 1 (cold) .....29°F .....  
 No. 4 (normal) .....31°F ..... 38°F  
 No. 7 (warm) ..... ..... 44°F  
 (A30-261 is an adaptable replacement.)

## WESTINGHOUSE

**Constant Cut-In type control**  
 Defrosts Household Refrigerator each cycle.  
 Replaces: C38285, 42104, 42105, 42107, 42110, 42111, 42115, 42116, 42117, 42118, \*42351, \*42353, \*42354, \*42355, \*42356, 42375, 42376, 42377, 42380, 42381, 42382, 42386.

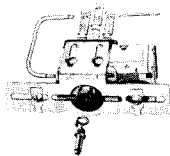

**A27-102**

\*SPDT switch action on original control. A27 switch CLOSES to terminals #2 & #3 (constant cut-in), OPENS to terminals #2 & #1 (constant cut-out) on RISE of temperature.  
 Mounting bracket adjustable to 7/8" height from control, and adjustable hole centers from 1 $\frac{3}{8}$ " to 2 $\frac{3}{8}$ ".  
 Parts package contents: 32" long plastic sleeve for capillary, 2 each mounting clips and screws, 3 terminal adapters, dial shaft extension.  
 Original knob fits dial shaft which turns CLOCKWISE from "cold" to "off". 36" cap. tube, no bulb.  
 FACTORY SETTING: CUT-OUT CUT-IN  
 Cold .....-14.5°F ..... 37.5°F  
 Normal (#2 & #3 term.) .....-4°F ..... 37.5°F  
 Warm .....7.5°F ..... 37.5°F

**Household Models.**  
 Replaces: C42101, 42102, 42109, 42113, 42371, 42378, 42384, 87575.

**A30-511**

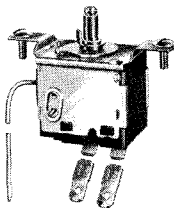

**A30-3505**

**Lowest CUT-OUT Point: -26°F.**  
**Highest CUT-IN Point: 34.5°F.**  
**Differential: 18°F Min., 21° Max.**  
 2 $\frac{1}{2}$ " mounting hole centers.  
 Original knob fits dial shaft which turns CLOCKWISE from "cold" to "off". 48" cap. tube, no bulb.  
 FACTORY SETTING: CUT-OUT CUT-IN  
 Cold .....-11°F .....  
 Normal .....-1°F ..... 19°F  
 Warm ..... ..... 30°F

**Freezer Models.**  
 Replaces: C42103, 42108, 42112, 42379.

**Lowest CUT-OUT Point: -23°F.**  
**Highest CUT-IN Point: 28°F.**  
**Differential: 8.5°F Min., 11.5°F Max.**  
 Specifications are the same as A30-511 EXCEPT: 24" cap. tube, no bulb.  
 FACTORY SETTING: CUT-OUT CUT-IN  
 Cold .....-13°F .....  
 Normal .....-7°F ..... 3°F  
 Warm ..... ..... 6.5°F

## WHIRLPOOL

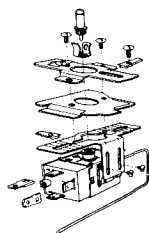

**A42-190**

**Constant Cut-In type control**  
 Defrosts RCA-Whirlpool Refrigerator each cycle.  
 Replaces the following RCA & GE controls:

RCA No.	GE No.	RCA No.	GE No.
42185	3ART10H1	511403	3ART10L7
42186	3ART10H2	511425	3ART10L8
43002	3ART10H3	513814	3ARTL10
43003	3ART10H4	515364	3ART6VL10
216520	3ART10E1	515498	3ART6VL11
505333	3ART10H6	518710	3ART6VL7
506632	3ART10H10	518711	3ART6VL2
506836	3ART10H8	518776	3ART6VL12
506837	3ART10H9	525283	3ART10L5
507580	3ART10H14	525497	3ART10H11
508071	3ART10H15	525949	3ART10L2
509123	3ART10L3	525950	3ART10L1
509499	3ART10L4	526571	3ART10H12
509994	3ART10L6		

Mounting bracket adjustable to 7/8" height from control and hole centers from 1 $\frac{3}{8}$ " to 3 $\frac{3}{8}$ ".  
 Parts package contents: 4 each mounting clips and screws, 1 dial shaft assembly, 1 driver, 2 adapter brackets (mounts on basic bracket after snapping off tab ends to adapt control), 2 terminal adapters.

**SPST switch with 3 terminals, #2 & #3 common.**  
 OFF position provided on cam.  
 60" cap. tube, no bulb.  
 FACTORY SETTING: CUT-OUT CUT-IN  
 Cold .....-16°F ..... 36°F  
 Normal .....-4°F ..... 36°F  
 Warm .....7.5°F ..... 36°F

## ZERO



**A10-3622**

**1949 through 1952**  
 Milk Cooler Model: T-33. Replaces R-101 (controls water spray pump).  
 2 $\frac{1}{8}$ " mounting hole centers.  
 Cat. 49610-1 dial plate with OFF position.  
 48" cap. tube, 3/8" x 6" bulb, cross-amb.  
 FACTORY SETTING: CUT-OUT CUT-IN  
 No. 7 .....Continuous Run  
 No. 6 .....23°F ..... 31°F  
 No. 1 (warm) ..... ..... 54°F

# CONTROL PARTS ILLUSTRATED

PARTS NOT ILLUSTRATED	
ITEM	CAT. NO.
CLAMP PACKAGE: for 019-1559 (for CUT-IN capillary tube) and 018-100	15574
DIAL KNOBS:	
for RJS-830 (for 8 sided dial shaft & with an arrow)	15340
for A13, A14, A15, A30, C12, C17, KJB, 025 (pointer with a set screw)	15515
for A10, A30, B, RJ-3166 (for single prong driver)	15909
for "0" (for serrated adjustment screw heads)	50156-1
for A10, A13, A30 (large, black with white numbers & OFF)	50839-1
for RJS (large, black with white numbers & OFF, for 8 sided dial shaft)	50903-1
DIAL PLATES:	
for RJ-3214 (large, horizontal, one end shorter)	50884-1
for A10-643, A10-738 (Frigidaire, long, 2 sets of holes)	51773-2
DIAL SHAFT ASSEMBLY	
3" shaft with flat for ADAPTABLES	57841-1
dial shaft assembly	58699-1
INSULATORS (complete with contacts):	
for 010, 011, 012, 018, 019 (side access terminals)	18195
for 010 with signal circuit (side access terminals, only)	18753
for 010, 011, 012, 018, 019 (front access terminals)	35736-1
for 020, 022 (side access terminals)	35975-1
for 021 side access terminals (except 021-100)	35979-1
POWER ELEMENT PACKAGE:	
for RJ & RJS (contains 4 each nuts & screws to attach element)	17188
SCREWS:	
for A10, A12, A30, A33, B, KR, KWS, RJ mounting bracket (8-32 x 3/8" long)	11342
for "0" mounting bracket (10-32 x 1/4" long)	14908
TERMINAL COVERS:	
for A10, A30 with signal circuit (order separately cat. 51554-2 holding screw to attach cover)	32482-1
for A15-116 (order separately cat. 42916-44 holding screw to attach cover)	33155-3
for A10, A12-1506, A13 screw type terminals only	50719-3
for A14-109, C12-5010 screw or quick-connect terminals	54212-1
for A12-1560 screw or quick-connect terminals	54253-1
for A30-1500, A33 screw or quick-connect terminals	57527-3
TOGGLE ASSEMBLY: (complete with contacts)	
for 010 single unit, TEMPERATURE	16923
for 010, 011, 012 single & dual units, PRESSURE	17151
toggle spring only	17085

## CONTROL PARTS ILLUSTRATED

### ADAPTER BRACKET

Use this bracket with RANCO controls, when required, for replacement of Frigidaire controls.

To be ordered separately for A10-608, 609, 632, 643 and A10-738.

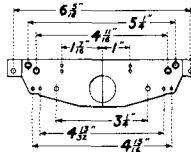

CAT. 52003-1

Clamp is complete as illustrated. Smaller, I.D. formed part of the clamp holds the 3/8" dia. bulb of the power element.

Larger I.D. formed part of the clamp attaches to 3/8" to 5/8" dia. evaporator tubing.

### BULB CLAMP

CAT. 7699

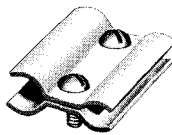

### BULB FORMING TOOL

Use this tool to form various type bulbs, coiled, twisted, air coiled, on capillary tubing.

CAT. 57963-1

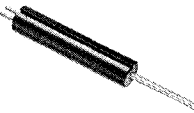

15 Bulb Forming Tools in 1 box.

CAT. 58203-1

Plate COVERS OPENING up to 1 7/8" x 4 3/16".  
Finish on plate is polished metal trim with dull background.

### DIAL PLATES FOR RJ and RJS

2 sets of mounting hole centers: 3 3/8" and 2 3/16"

ILLUSTRATION is the same as CAT. 50191-2, except with 1 set of mounting hole centers: 3 3/8" apart.

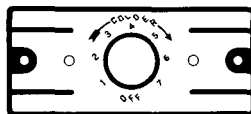

CAT. 50191-1

CAT. 50191-2

3 3/8" mounting hole centers.

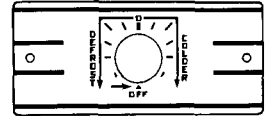

CAT. 14540

Finish on plate is polished metal trim with black background.

2 sets of mounting hole centers: 3 3/8" & 2 3/16"

3 3/8" mounting hole centers.

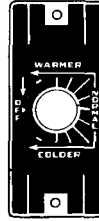

CAT. 14576

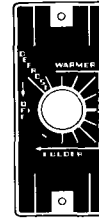

CAT. 15269

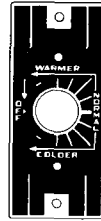

CAT. 46636-3

FOR A10, A13, A15, A30 & B

Plate COVERS OPENING up to 2 3/8" x 3".

Finish on plate is polished metal trim with black or dull background. 2 3/8" mounting hole centers on each

BLACK BACKGROUND

DULL BACKGROUND

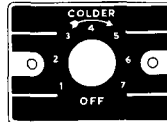

CAT. 49610-1

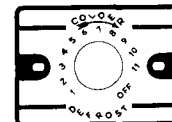

CAT. 50060-1

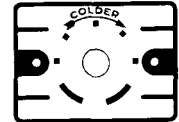

CAT. 52578-1

Plate COVERS OPENING up to 1 5/8" x 1 3/16".  
Finish on plate is polished metal trim with dull background.

For A14, C12 & C17

1 3/8" & 1 3/16" centers within slotted mounting holes.

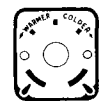

CAT. 53684-1

### MAGNET PACKAGES

CAT. 16993 (For "0")

D.C. rating is increased by the use of the magnet package in the control.

The Package contains a RETAINING CLIP and a MAGNET.

The MAGNET, Cat. 13173, is inserted into the cavity in the insulator with its magnet poles facing the switch contacts.

Firmly press the RETAINING CLIP down on top of the magnet.

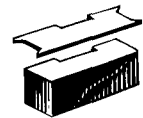

CAT. 17097 (For "RJ" & "RJS")

### MOUNTING BRACKETS FOR HOUSEHOLD CONTROLS

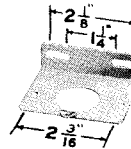

CAT. 49651-1

2 3/8" mounting hole centers across cut out hole for dial shaft to attach A10, A30, RJ, RJS and ADAPTABLES.

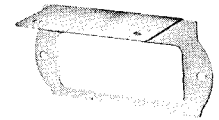

CAT. 10291

3 3/8" mounting hole centers across the cut out section for attaching RJS and ADAPTABLES.

TRANSVERSE MOUNTING BRACKET for attaching ADAPT-ABLE controls in certain applications.

CAT. 58649-1

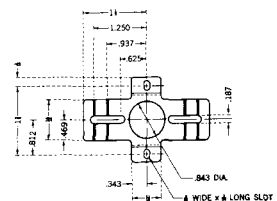

RANCO



# CONTROL PARTS ILLUSTRATED

## MOUNTING BRACKETS

### FOR COMMERCIAL CONTROLS

Single Unit controls: 010, 011, 015, 016, 018, 019, 020, 021, 022, and 025.

TEMPERATURE  
(Optional for Pressure)

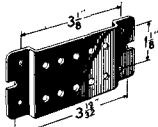

**CAT. 16859**

Low or High

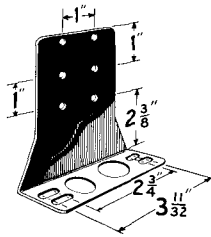

**CAT. 16860**

Optional (Use mounting screws 46862-3)

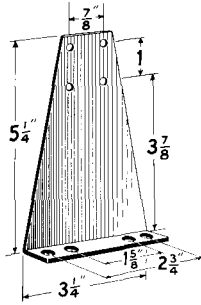

**CAT. 17312**

Dual Unit controls 012 and 022.

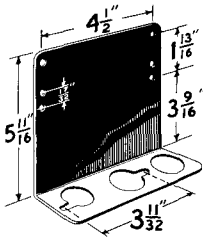

**CAT. 17261**

DUAL PRESSURE  
and  
DUAL TEMPERATURE

## SUPPORT PLATES

"018" & "021"

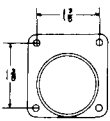

**CAT. 48351-2**

Support Plates listed replace older plates having a smaller diameter hole used on **HIGH PRESSURE POWER ELEMENTS** which require replacing with current elements, Cat. 320491-1 or 320662-1.

"KOH", "010", "011"

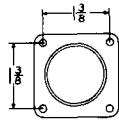

**CAT. 44991-2**

"012" (DUAL)

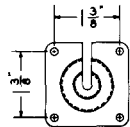

**CAT. 52260-1**

SUPPORT PLATE is used with Hydraulic type Power Element Assembly

## OVERLOAD HEATER COILS & JUMPER

### FOR KO, KR, KWS TYPES

Ampere Rating	Cat. No.	Ampere Rating	Cat. No.
2.1	10269	5.5	10076
2.7	10068	6.1	10286
3.0	10069	6.8	10079
3.6	10071	7.0	10080
4.3	10270	8.0	10082
4.5	10073	10.0	10085
5.1	10075	12.0	10087



(Heater Coils are interchangeable)

If Ampere rated coil DESIRED does not appear on above list, **SELECT THE NEXT LOWEST RATED COIL.**

The AMPERE RATING listed is the current at which the control will ultimately trip when the surrounding temperature is 104°F (40°C.).



**CAT. 10323**

The formed **JUMPER** illustrated replaces the Overload Coil using the same attaching screws.

## POWER ELEMENTS

### LOW PRESSURE

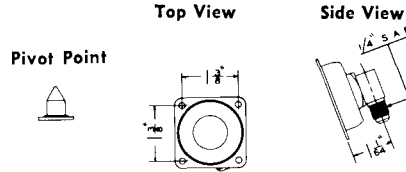

Angle Fitting

For Use on the Following:

RANGE (See Scale Plate on Control)	PIVOT POINT PART NO.	POWER ELEMENT PART NO.
12" Vac. to 50 PSI 5 PSI to 95 PSI	13901	32094-1
0 PSI to 100 PSI 10" Vac. to 95 PSI	17062	32094-3

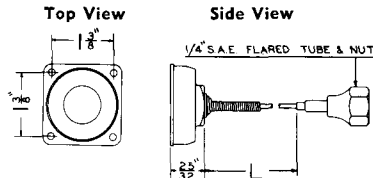

Capillary Tube

For Use on the Following:

RANGE (See Scale Plate on Control)	PIVOT POINT PART NO.	"L" DIM.	POWER ELEMENT PART NO.
12" Vac. to 50 PSI 5 PSI to 95 PSI	13901	36"	32107-1
		48"	32107-5
		36"	32107-6
10" Vac. to 95 PSI 0 PSI to 100 PSI	17062	36"	1/4" x 3" sweat fitting
		48"	32107-21 32107-19

### HIGH PRESSURE

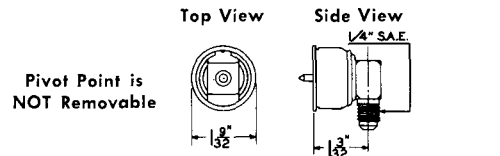

Angle Fitting

For Use on the Following:

RANGE (See Scale Plate on Control)	CONTROL DESCRIPTION	POWER ELEMENT PART NO.
100 PSI to 250 PSI 100 PSI to 360 PSI	Single or Dual	32117-1
250 PSI to 450 PSI 150 PSI to 450 PSI	Dual Only	
150 PSI to 450 PSI	Single Only	320662-1

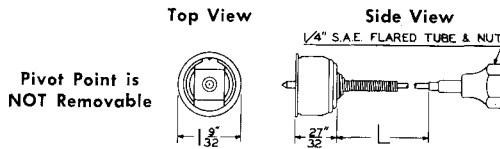

Pivot Point is NOT Removable

RANGE	CONTROL DESCRIPTION	"L" DIM.	POWER ELEMENT PART NO.
100 PSI to 250 PSI 100 PSI to 360 PSI	Single or Dual	36"	32116-1
		48"	32116-2
250 PSI to 450 PSI 150 PSI to 450 PSI	Dual Only	36"	32241-1
150 PSI to 450 PSI	Single Only	36"	1/4" x 3" Sweat Fitting 320491-1

### TEMPERATURE

#### FOR "0" CONTROLS

Flanged—1 1/2" diameter bellows—3/32" diameter capillary tube.

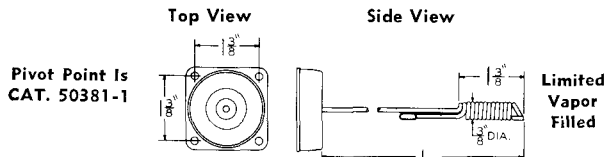

Pivot Point Is CAT. 50381-1

Limited Vapor Filled

RANGE: 25° to 75° F	25"	CAT. 32084-3
	48"	CAT. 32084-4
RANGE: 0° to 55° F	48"	CAT. 32084-6
	66"	CAT. 32084-7
RANGE: -15° to 40° F	48"	CAT. 32084-1

# CONTROL PARTS ILLUSTRATED

## POWER ELEMENTS

### TEMPERATURE For "O" Controls

$\frac{3}{32}$ " diameter capillary tube,  
Flanged— $1\frac{1}{2}$ " diameter bellows

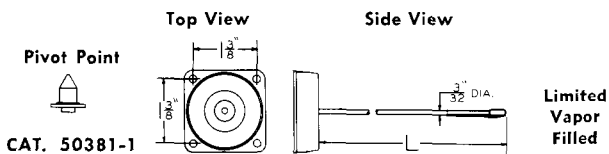

<b>RANGE: 50° to 105°F</b>	L.....48" .....	CAT. 32081-55
<b>RANGE: 25° to 75°F</b>	L.....48" .....	CAT. 32081-24
	L.....76" .....	CAT. 32081-11
<b>RANGE: 0° to 55°F</b>	L.....38" .....	CAT. 32081-15
	L.....48" .....	CAT. 32081-7
	L.....76" .....	CAT. 32081-1
	L.....96" .....	CAT. 32081-6
	L.....144" .....	CAT. 32081-25
<b>RANGE: -15° to 40°F</b>	L.....31" .....	CAT. 32081-30
	L.....48" .....	CAT. 32081-56
	L.....120" .....	CAT. 32081-14
<b>RANGE: -35° to 15°F</b>	L.....48" .....	CAT. 32081-52
	L.....76" .....	CAT. 32081-47
	L.....84" .....	CAT. 32081-54

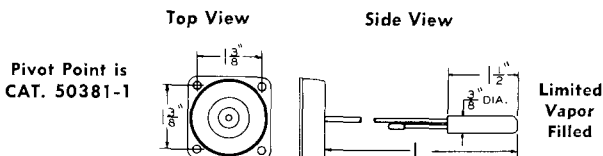

<b>RANGE: 50° to 105°F</b>	L.....76" .....	CAT. 32086-46
<b>RANGE: 30° to 90°F</b>	L.....76" .....	CAT. 32086-13
<b>RANGE: 25° to 75°F</b>	L.....48" .....	CAT. 32086-2
	L.....76" .....	CAT. 32086-6
	L.....144" .....	CAT. 32086-12
<b>RANGE: 0° to 55°F</b>	L.....25" .....	CAT. 32086-1
	L.....60" .....	CAT. 32086-19
	L.....76" .....	CAT. 32086-4
	L.....96" .....	CAT. 32086-28
	L.....144" .....	CAT. 32086-11
<b>RANGE: -15° to 40°F</b> or 0° to 50°F	L.....76" .....	CAT. 32086-5
	L.....144" .....	CAT. 32086-18
<b>RANGE: -35° to 15°F</b> or -30° to 20°F	L.....48" .....	CAT. 32086-44
	L.....76" .....	CAT. 32086-43
	L.....144" .....	CAT. 32086-40

## TEMPERATURE (continued) For "O" Controls

$\frac{3}{32}$ " diameter capillary tube,  
Flanged— $1\frac{1}{2}$ " diameter bellows

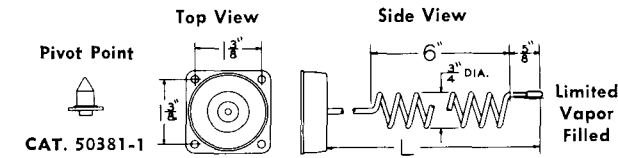

<b>RANGE: 40° to 85°F</b>	L.....84" .....	CAT. 32115-14
<b>RANGE: 0° to 55°F</b>	L.....84" .....	CAT. 32115-2

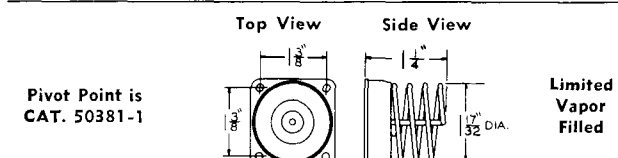

<b>RANGE: 25° to 75°F</b>	<b>Air Coil</b> .....	CAT. 32115-7
<b>RANGE: 0° to 55°F</b>	<b>Air Coil</b> .....	CAT. 32115-1
<b>RANGE: -35° to 15°F</b>	<b>Air Coil</b> .....	CAT. 32115-17

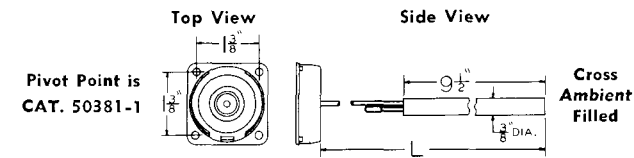

<b>RANGE: 50° to 105°F</b>	L.....84" .....	CAT. 32076-13
<b>RANGE: 30° to 50°F</b>	L.....48" .....	CAT. 32076-5
or 25° to 45°F	L.....84" .....	CAT. 32076-1
or 25° to 75°F	L.....144" .....	CAT. 32076-2
<b>RANGE: 0° to 55°F</b>	L.....84" .....	CAT. 32076-3

### For O18 and O21-100 Controls

$\frac{3}{4}$ " diameter capillary tube,  
Hydraulic action Power Element

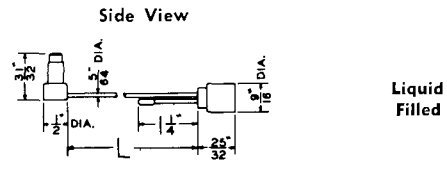

<b>OPERATING POINT: 32°F</b>	L.....72" .....	CAT. 52266-1
------------------------------	-----------------	--------------

## DIMENSIONS & MOUNTING HOLES LOCATIONS

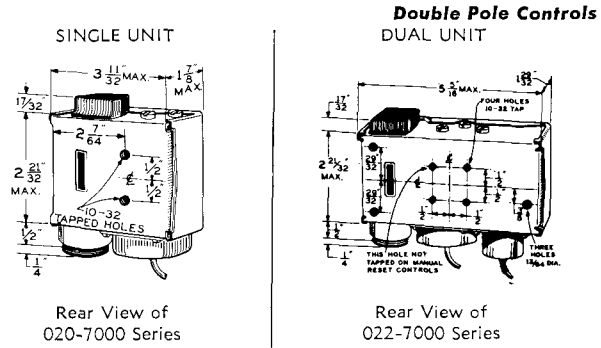

Rear View of  
O20-7000 Series

Rear View of  
O22-7000 Series

R  
A  
N  
C  
O

# CONTROL PARTS ILLUSTRATED

## DIAL SHAFT

3" long dial shaft with full length flat is grooved every 1/2" for easy shortening for any adaptable model.

**CAT. 57841-1**

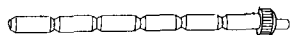

## EXTENSION for DIAL SHAFT

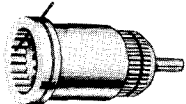

1/2" long extension shaft seats in any adaptable control. Its opposite end, having a spring lock, secures any adaptable dial shaft, driver or additional extension.

**CAT. 59581-1**

## TERMINAL COVERS

### SCREW TYPE TERMINALS ONLY

**A10, A12, A13 and A26**

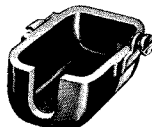

**CAT. 50719-3**  
5/16" opening

**A10, A30 Signal Switch**

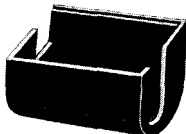

(Order Cat. 51554-2 screw separately to attach cover.)

**CAT. 32482-1**

## QUICK-CONNECT TERMINALS (or Screw type)

*NOTE: Use flag type slip-on terminals when cover is used.*

**A10, A30 Signal Switch**

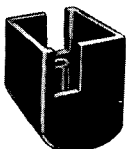

(Order Cat. 51554-8 screw separately to attach cover.)

**CAT. 37980-1**

**A10, A12, A13 and A26**

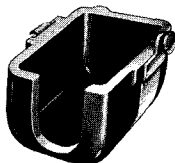

**CAT. 54253-1**  
1/2" opening

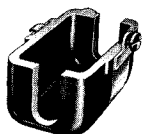

**CAT. 54253-3**  
5/16" opening

**A30 and A33**

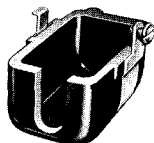

**CAT. 57527-1**  
1/2" opening

**CAT. 57527-3**  
5/16" opening

**A30 and A33**

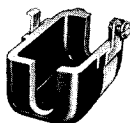

**CAT. 57527-2**  
two 5/16" openings

**A42**

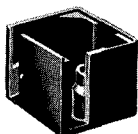

(Order Cat. 51554-1 screw separately to attach cover.)

**CAT. 58191-1**  
.272" opening

**CAT. 58191-2**

two .272" openings

**A11, A14, and A18**

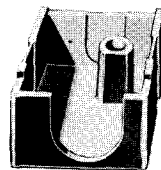

(Order Cat. 51554-2 screw separately to attach cover.)

**CAT. 54211-1**  
5/16" opening

**CAT. 54211-2**  
two 5/16" openings

**CAT. 54212-2** 5/8" opening

**CAT. 54212-1** 5/8" & 5/16" openings

**A15**

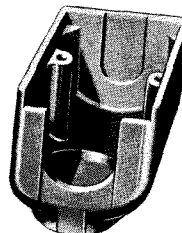

(Order Cat. 42916-44 screw separately to attach cover.)

**CAT. 33155-2**  
13/32" opening

**CAT. 33155-3**  
5/8" opening

**CAT. 33155-4** 21/32" opening on top

**CAT. 33155-5** 13/32" & 5/8" openings

## RELAY PACKS

### H80-6 PACK

1 each of H80-2101  
2104  
2105  
2106  
2107  
2115



### H80-12 PACK

1 each of H80-2102  
2105  
2109  
2116  
2104  
2106  
2115  
2119  
2 each of H80-2101  
2107



## H80 PARTS PACKAGE

**CAT. 58679-1**

### CONTENTS

6 Terminal Screws  
5 Quick-connect Adapters:—  
1 4-tab terminal  
4 2-tab terminals

R  
A  
N  
C  
O

# RELAYS—EXACT REPLACEMENT & ADAPTABLE

## EXACT REPLACEMENTS

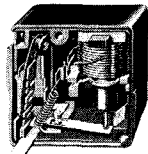

**H60**

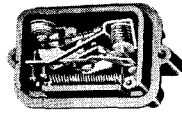

**I10**

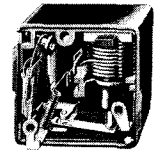

**H65**

Original Part Number	Replacement Relay	Horsepower	Voltage	Cycle
<b>GENERAL ELECTRIC</b>				
CR1057M217AH27	<b>H60-200</b>	1/8	115	60
CR1057M217AT21	<b>H60-202</b>	1/8	230	50
CR1057M221AN30	<b>H65-301</b>	1/6	115	60
CR1057M300AF31	<b>H65-300</b>	1/8	115	60
CR1057M300AK29	<b>H65-304</b>	1/3	115	60
CR1057M300AL28	<b>H65-303</b>	1/4	115	60
CR1057M300AM26	<b>H65-302</b>	1/6	115	60
CR1057M301AM26	<b>H60-201</b>	1/6	115	60
<b>HOTPOINT</b>				
104542	<b>H65-310</b>	1/8	115	60
104982	<b>H65-301</b>	1/6	115	60
105620	<b>H60-200</b>	1/8	115	60
105621	<b>H60-201</b>	1/6	115	60
105639	<b>H60-200</b>	1/8	115	60
<b>KELVINATOR</b>				
1068385	<b>110-100</b>	1/8	115	60
1068386	<b>110-102</b>	1/4	115	60
1068387	<b>110-103</b>	1/3	115	60
1068388	<b>110-104</b>	1/2	230	60
1068397	<b>110-107</b>	1/4	115	60
1068398	<b>110-101</b>	1/6	115	60
1068783	<b>110-106</b>	1/5	115	60
1068847	<b>110-108</b>	1/3	115	60
1112278	<b>110-105</b>	1/6	115	60
1112410	<b>110-111</b>	1/8	115	60
1112411	<b>110-110</b>	1/3	115	60
1112412	<b>110-109</b>	1/3	115	60
1112434	<b>110-112</b>	1/3	115	60
1112435	<b>110-113</b>	1/3	115	60
1112532	<b>110-114</b>	1/5	115	60
1112575	<b>110-117</b>	1/3	115	60
1112580	<b>110-118</b>	1/3	115	60
1112583	<b>110-116</b>	1/4	115	60
1112589	<b>110-115</b>	1/4	115	60
1112647	<b>110-119</b>	1/2	115	60
1112902	<b>110-120</b>	1/2	230	60
1112908	<b>110-121</b>	1/2	115	60
1112969	<b>H60-200</b>	1/8	115	60
1112970	<b>H60-202</b>	1/8	230	50
1112971	<b>H60-201</b>	1/6	115	60

Original Part Number	Replacement Relay	Horsepower	Voltage	Cycle
1113023	<b>H60-200</b>	1/8	115	60
1113024	<b>H60-202</b>	1/8	230	50
1113025	<b>H60-201</b>	1/6	115	60
1113174	<b>H65-302</b>	1/6	115	60
1113175	<b>H65-301</b>	1/6	115	60
1113176	<b>H65-303</b>	1/4	115	60
1113180	<b>H65-304</b>	1/3	115	60
1113181	<b>H65-300</b>	1/8	115	60
1113182	<b>H65-302</b>	1/6	115	60
1113183	<b>H65-301</b>	1/6	115	60
1113184	<b>H65-303</b>	1/4	115	60
1113188	<b>H65-304</b>	1/3	115	60
1113189	<b>H65-300</b>	1/8	115	60
1113317	<b>H65-306</b>	1/4	115	60
1113318	<b>H65-307</b>	1/3	115	60
1113386	<b>H65-305</b>	1/8	115	60
1113439	<b>H65-311</b>	1/4	115	60
1113588	<b>H65-309</b>	1/4	115	60
1113743	<b>H60-204</b>	1/8	115	60
1113745	<b>H60-205</b>	1/6	115	60
1113756	<b>H65-314</b>	1/4	115	60
1113757	<b>H65-315</b>	1/3	115	60
1113767	<b>H65-317</b>	1/6	115	60
1113768	<b>H65-319</b>	1/6	115	60
1113772	<b>H65-318</b>	1/8	115	60
1113910	<b>H65-319</b>	1/6	115	60
1113944	<b>H65-320</b>	1/4	115	60
1113953	<b>H65-321</b>	1/4	115	60
1113954	<b>H65-322</b>	1/3	115	60
1161752	<b>H65-308</b>	1/5	115	60
<b>KELVINATOR OF CANADA</b>				
719795	<b>H65-310</b>	1/8	115	60
<b>VENDO</b>				
A-42580-1	<b>H65-302</b>	1/6	115	60
A-42580-2	<b>H65-300</b>	1/8	115	60
A-42580-3	<b>H65-305</b>	1/8	115	60
A-42580-4	<b>H65-309</b>	1/4	115	60

## ADAPTABLE VOLTAGE STARTING RELAYS

Order by Ranco Code No.	Continuous Coil Volts	Pick-Up Contacts Open		Drop-Out Contacts Close	
		Min. Volts	Max. Volts	Min. Volts	Max. Volts
<b>WITH ADAPTABLE BRACKET</b>					
<b>H80-2101</b>	130	139	153	15	35
<b>-2102</b>	256	296	325	35	77
<b>-2103</b>	256	159	172	35	77
<b>-2104</b>	336	261	290	50	100
<b>-2105</b>	336	280	309	50	100
<b>-2106</b>	336	299	327	50	100
<b>-2107</b>	336	166	179	37	85
<b>-2108</b>	495	280	310	60	135
<b>-2109</b>	420	328	356	60	121
<b>-2110</b>	396	190	215	40	105
<b>-2111</b>	420	262	290	60	121
<b>-2112</b>	495	328	356	60	135
<b>-2113</b>	420	223	252	60	121
<b>-2114</b>	495	239	268	60	135
<b>-2115</b>	495	295	324	60	135
<b>-2116</b>	396	180	195	40	105
<b>-2117</b>	420	204	233	60	121
<b>-2118</b>	336	245	275	40	90
<b>-2119</b>	170	140	153	20	45
<b>-2120</b>	396	305	335	60	121
<b>-2121</b>	336	317	345	50	100
<b>-2122</b>	336	186	215	40	90

Order by Ranco Code No.	Continuous Coil Volts	Pick-Up Contacts Open		Drop-Out Contacts Close	
		Min. Volts	Max. Volts	Min. Volts	Max. Volts
<b>WITH SHROUDED CASE, NO BRACKET</b>					
<b>H80-4101</b>	130	139	153	15	35
<b>-4102</b>	256	296	325	35	77
<b>-4103</b>	396	305	335	60	121
<b>-4104</b>	420	328	356	60	121

### WIRING DIAGRAM

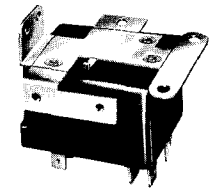
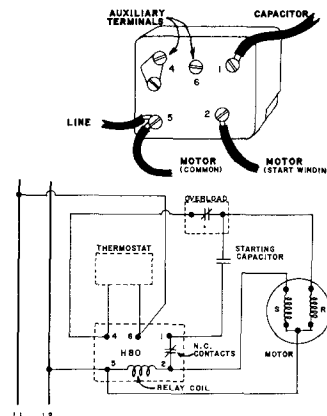

**H80  
WITH  
BRACKET  
RELAY COVER  
CAT. 20850-1**

R  
A  
N  
C  
O

# ELECTRICAL RATINGS OF CONTROLS

LISTED by Underwriters' Laboratories and Canadian Standards Association—unless otherwise noted.

Type of Controls	Switch Action	VOLTAGES	FULL LOAD	LOCKED ROTOR	(Non-inductive)	
			Maximum Motor AMPERE Rating			
<b>A10, A12, A13</b>	<b>SPST</b>	120/*208 ac	16.0	84.0		
		120/240 ac, 3-wire	16.0	84.0		
		240 ac	8.3	41.7		
<b>A11, A14</b>	<b>SPDT</b>	*208 ac	20.0	78.0		
		240 ac	8.3	39.0		
<b>A26</b>	<b>SPST</b>	120/240 ac, 3-wire	20.0	78.0	25 AMPERES	
		120/*208 ac	16.0	60.0		
<b>A27</b>	<b>SPDT</b>	240 ac	8.3	41.7		
		120/240 ac, 3-wire	16.0	60.0		
<b>A30, A33</b>	<b>SPST</b>	120/*208 ac	20.0	78.0		
<b>A42</b>	<b>SPST</b>	240 ac	8.3	39.0		
		240 ac or less	20.0	80.0		
<b>C12, C17</b>	<b>SPDT</b>	240 ac or less	8.0	42.0		
		120 ac	20.0	80.0		
<b>D52</b>	<b>SPDT</b>	240 ac	20.0	80.0	4800 WATTS	
		120/*208 ac	20.0	78.0		
<b>E11, Terminals 3 &amp; 4</b>		240 ac	8.33	39.0		
		115 ac	7.4	45.0		
<b>E11, E13, Terminals 3 &amp; 2</b>		230 ac	3.7	23.0		
		115/230 ac			1000 WATTS	
<b>E15</b>	<b>SPST</b>	120/240 ac	20.0	80.0		
	<b>SPDT</b>	120/240 ac	10.0	40.0		
<b>F11 (1000, 1200 &amp; 1300)</b>		115 ac	7.4	45.0	1000 WATTS	
		230 ac	3.7	23.0	1000 WATTS	
<b>F17, Terminals 1 &amp; 3</b>	<b>SPST</b>	115/230 ac	16.0	78.0		
		(with Fan Switch)	115 ac	10.0	60.0	
<b>F17, Terminals 2 &amp; 3</b>	<b>SPST</b>	230 ac	5.0	30.0		
		120 ac	6.5	39.0		
<b>J12</b>	<b>SPST</b>	120 ac	7.5	45.0		
		1500 Series	240 ac	3.3	20.0	
<b>J13</b>		120 ac	6.5	39.0		
		2500 Series	240 ac	3.3	20.0	
		3500 Series	120 ac	3.0	18.0	
<b>PILOT DUTY</b>						
	<b>025 (UL only)</b>	345 Volt-ampere at 230 Volts, ac.				
	<b>E11, E13, Terminals 2 &amp; 3</b>	125 Volt-ampere at 115/230 Volts, ac.				
	<b>E15</b>	240 Volt-ampere at 120/240 Volts, ac.				
	<b>J12, J13</b>	240 Volt-ampere at 120/240 Volts, ac.				
	<b>010, 011, 012, 018, 019</b>	720 Volt-ampere at 120/240 Volts, ac. 125 Volt-ampere at 240/600 Volts, ac. 57.5 Volt-ampere at 120/240 Volts, dc, with a magnet.				
	<b>020, 021, 022</b>	125 Volt-ampere at 120/600 Volts, ac. 57.5 Volt-ampere at 120/600 Volts, dc.				
<b>SIGNAL CIRCUIT</b>						
	<b>A10, 010</b>	1.0 Ampere at 240 Volts, ac. 0.1 Ampere at 240 Volts, dc.				
	<b>A30</b>	1.0 Ampere at 240 Volts, ac, or less.				

**NOTES:**

- (1) Unimax Auxiliary Switch on A30 3000 series code is rated 15 amperes (non-inductive) at 125/250 V. ac.
- (2) \*208 Volt rating is based on supply circuit (120/208V 4-wire) with 120 Volts to ground.

### NON-CATALOGED CONTROLS

**Regular cataloged controls** are shipped from stock within a few days after receipt of order.

**Special, non-cataloged controls** are processed independently and not included with cataloged controls so shipping of stocked items are not delayed.

**Specifications of "special" ordered controls** are checked for possible conversion from either similar current production or cataloged replacement controls. If this is not practical, the control is scheduled to be built.

**Out-of-production part(s)** might not be available to produce the scheduled control. A **form card** will then be mailed stating the non-availability of the ordered control. And it further suggests to ship the defective control to Ranco Repair Department, **transportation prepaid both ways**, for repair and return as an expediency to an outside Service Department to put the customer's refrigerator back in operation. This **form card does not imply** the non-availability of the same control the next time there is a requirement for the same control.

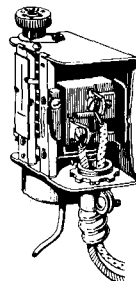

**FRONT ACCESS** type Terminals (illustrated) are on most "O" controls.

**SIDE ACCESS** type Terminals (not illustrated) are on:

- (1) "010" with Signal Circuit,
- (2) Controls with Quick-connect Terminals and
- (3) Double Pole Controls.

## "O" SERIES COMMERCIAL CONTROLS DEFINITION OF TERMS

The following information is included to help towards a better understanding of the terms used in describing the action and specifications of the "O" Series Commercial controls.

### SWITCH ACTION

STANDARD	Contacts CLOSE ON RISE of temperature or pressure.
REVERSE	Contacts OPEN ON RISE of temperature or pressure.
S.P.D.T. (Single Pole-Double throw)	One circuit OPENS, and one circuit CLOSES simultaneously on RISE of temperature or pressure.

### EXAMPLE OF TERMS FOR STANDARD SWITCH ACTION

OPERATING RANGE (Lowest <b>Cut-out</b> to Highest <b>Cut-in</b> ) .....	20" Vac. to 100 P.S.I.
ADJUSTABLE RANGE (Lowest <b>Cut-in</b> to Highest <b>Cut-in</b> ) .....	0 P.S.I. to 100 P.S.I.
DIFFERENTIAL RANGE (Minimum to Maximum Differential) .....	10 P.S.I. to 40 P.S.I.
CUT-OUT (Cut-in minus Differential) .....	CUT-IN 50 P.S.I.
	DIFF. 10 P.S.I.
	CUT-OUT 40 P.S.I.

## Warranty

All of our products are thoroughly inspected and tested before leaving this factory and are guaranteed against defects in material and workmanship. All materials substituted because of shortages of preferred materials, will be the best available. Any part proving to our satisfaction to be defective when shipped from the factory, except substitute material, and which is returned to this factory within twenty-four (24) months of date of shipment therefrom, transportation prepaid, will be replaced or repaired on a gratis basis. This warranty may be voided by evidence of misuse or improper application. The warranty is limited to the REPAIR OR REPLACEMENT of the part only, and WE DO NOT ASSUME LIABILITY of any kind for the use or misuse of such equipment or the results therefrom. We assume no responsibility beyond the replacement or repair of the defective part, at this factory. Changes and improvements may be made at any time in Ranco products, but Ranco Incorporated shall be under no obligation to incorporate same in or substitute the same for any products previously delivered to any customer.

**Ranco**<sup>®</sup>  
INCORPORATED

R  
A  
N  
C  
O



*See Page 7*

→ **Halstead & Mitchell**

*Mechanically cleanable*

# WATER-COOLED CONDENSERS

*for refrigeration and  
air conditioning*

WR-300

- 1**
- WATER COOLED  
CONDENSERS**
- Close Coupled
  - Sea Water
  - Commercial Refrigeration

- 2**
- PLATE FINNED COILS**
- Direct Expansion
  - Hot and Chilled Water
  - Steam

- 3**
- AIR HANDLERS**
- Suspended, Horizontal
  - Floor Mounted, Vertical
  - Remote Fan/Coil

- 4**
- AIR COOLED  
CONDENSERS**
- Propeller Fan, Horizontal
  - Propeller Fan, Vertical
  - Centrifugal Fan, Vertical
  - Centrifugal Fan, Horizontal

- 5**
- COOLING TOWERS,  
EVAPORATIVE  
CONDENSERS**
- Standard Propeller Fan
  - Standard or Take-apart Centrifugal Fan
  - Evaporative Condensers
  - Closed Circuit Evaporative Water Coolers

- 6**
- RELATED  
EQUIPMENT**
- Water Pumps
  - Receivers

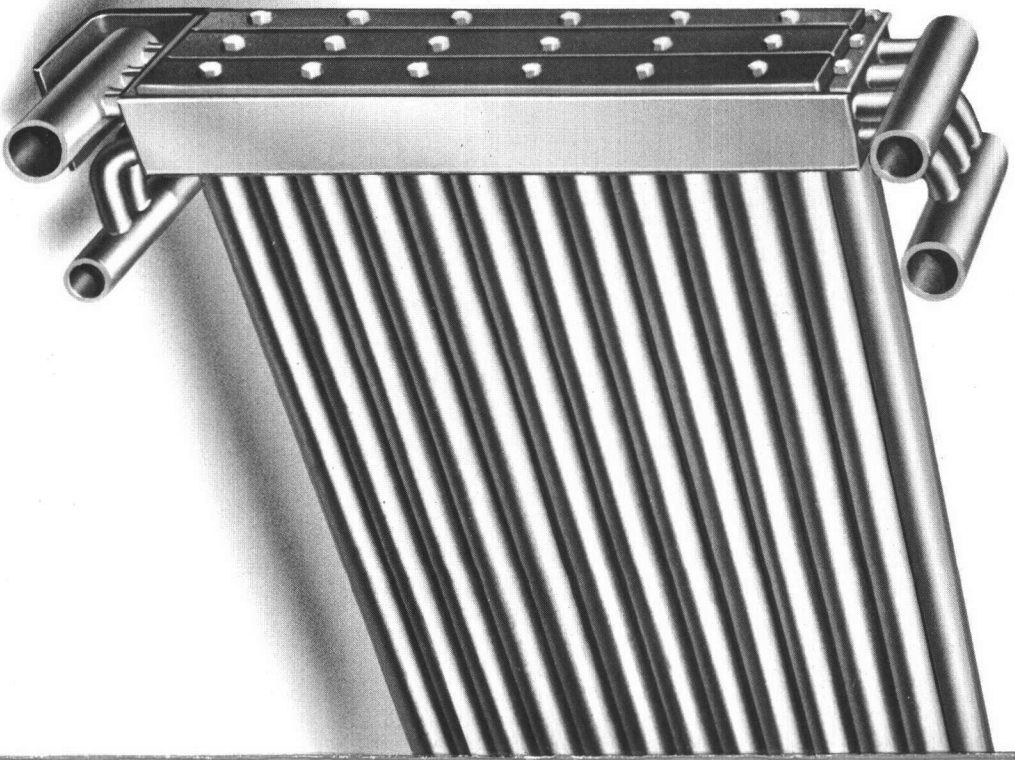

**5**

**different  
types**

**to match your  
refrigeration and  
air conditioning  
needs**

BULLETIN WC-301



# Here's why you should choose Halstead & Mitchell water-cooled condensers . . .

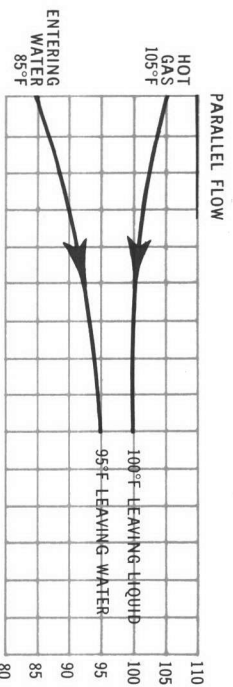
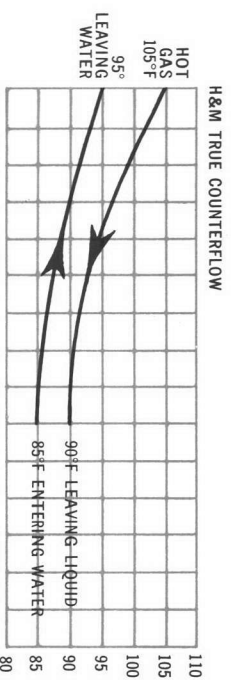

**More capacity without additional power input  
through true counterflow**

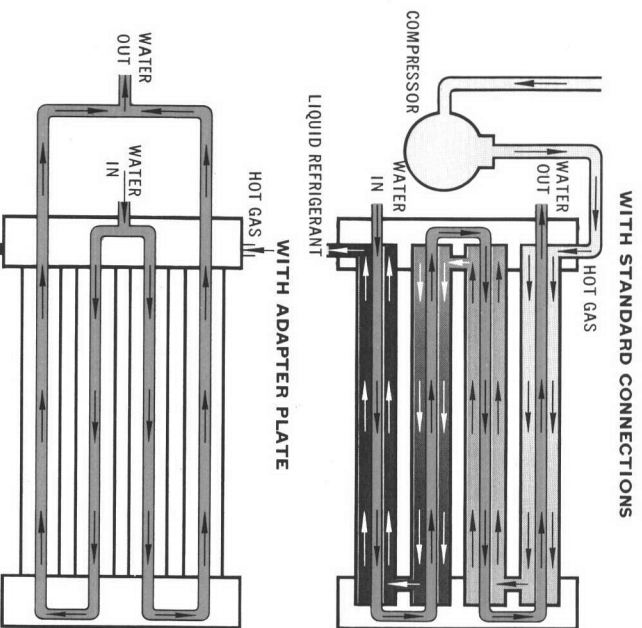

Use H & M adapter plates to provide split circuit arrangement that will handle greater water flow quantities—as on cooling tower use—without excessive pressure drop.



*Cutaway showing spiral wire cleaning tool used for easy, safe, mechanical cleaning of H & M condensers.*

H&M condensers are especially designed for refrigeration and air conditioning condensing units where minimum space requirements must be met. These efficient, water-cooled units keep compressor head pressures low, electric costs down. Condensers may be located in crowded equipment rooms, on racks, or outdoors. They'll always perform well and quietly since there are no moving parts.

Because they are cleanable, H&M condensers are particularly adaptable to refrigeration units in localities having water with a high mineral content. Where water supply is limited, use matching Halstead & Mitchell cooling towers to realize even greater economies. When condensers are used with cooling tower flow rates, it is advisable to use a split water circuit to reduce water pressure drop. Cooling tower adapter plates are available.

Water tubes are generously sized for low pressure drop and minimum maintenance. The high ratio of primary to secondary surfaces produces a better fouling factor. All tubing is of seamless copper. Headers are of brass, precision machined and brazed to the tubing.

Every H&M condenser is tested for leaks under 400 psi air pressure, dehydrated and checked electronically while charged with refrigerant. Condensers are approved by Underwriters' Laboratories.

### DOUBLE TUBE, COUNTERFLOW DESIGN FOR GREATER LIQUID SUBCOOLING

Refrigerant and cooling water are introduced in *true counterflow* in H&M condensers. Test results indicate that this produces an average of 15 degrees of liquid subcooling. And, since liquid refrigerant leaves at a lower temperature, system capacity is increased about 1½% for each degree of subcooling—without additional power input.

The tube-within-a-tube design maintains maximum heat exchange over the total length of the condenser tubes. Refrigerant flows through the outer tubes and is partly cooled by the surrounding air as well as by the water in the inner tubes.

### END PLATES EASILY REMOVED FOR SAFE, MECHANICAL CLEANING

Mineral scale and sludge deposits seriously reduce heat transfer in any condenser and affect system performance unless removed. But deposits can be cleaned from H&M water-cooled condensers safely—mechanically—to restore "new unit efficiency" quickly! No need to risk acid damage to condensers, cooling towers and pumps.

The end plates can be removed quickly and easily to provide complete access to the water tubes. A simple, spiral wire cleaning tool is inserted and powered by an ordinary electric drill to remove the corrosive material.

### EL series... STANDARD... 1/3 to 3-Ton

PAGE 3

Especially for new commercial refrigeration applications and for increased condenser capacity when added to an air-cooled unit.

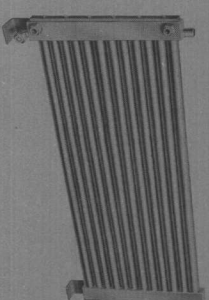

### T series... HEAVY DUTY... 1/3 to 25-Ton

PAGE 4

Highly favorable scaling factor makes these condensers ideal for use in areas with poor water conditions.

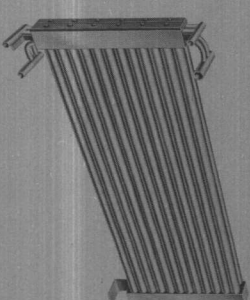

### R series... CLOSE-COUPLED... 1 1/2 to 10-Ton

PAGE 5

Use these condensers in packaged air conditioners and other special applications where overall length must be considered.

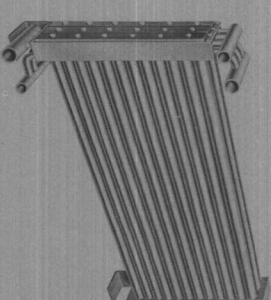

### WR series... MULTI-SECTION... 2 to 7 1/2-Ton

PAGE 6

Here is the perfect condenser for rack-mounted condensing units where very short condensers are needed along with exceptionally low water pressure drop.

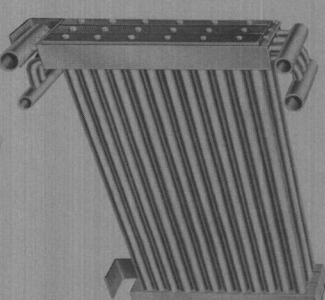

### SW series... SEA WATER... 1/3 to 25-Ton

PAGE 7

Cupro-nickel tubes and naval brass headers make these condensers particularly resistant to salt water and other corrosive water conditions.

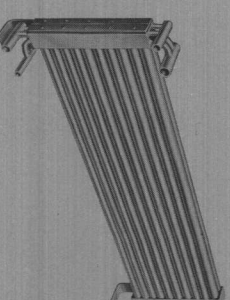

### WATER CONSUMPTION AND PRESSURE DROP DATA

PAGE 8

# EL series

standard for most  
commercial refrigeration applications

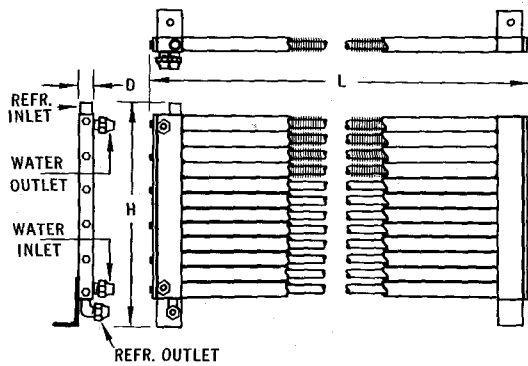
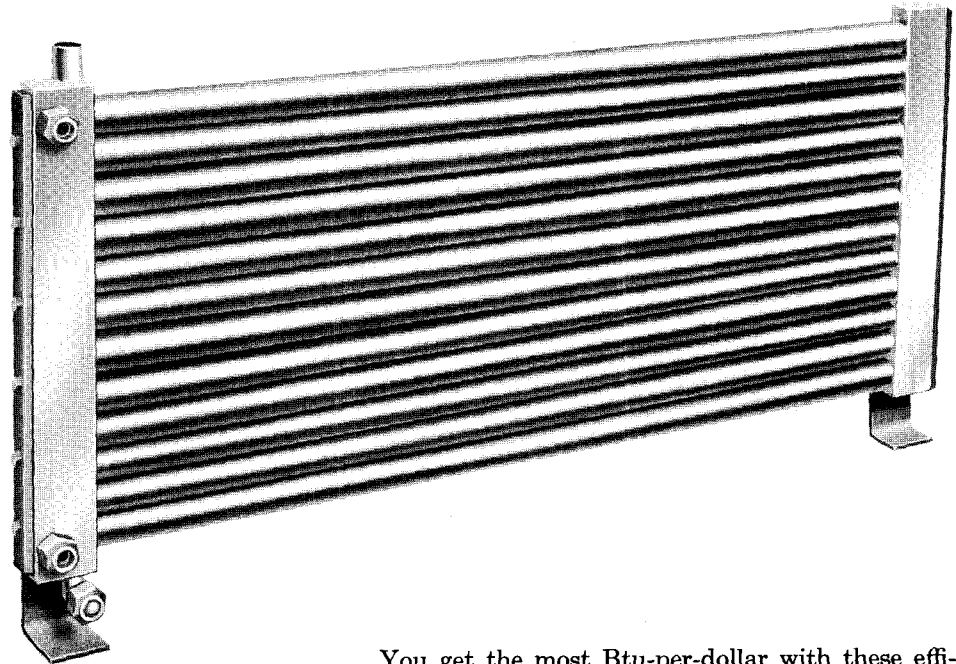

You get the most Btu-per-dollar with these efficient water-cooled condensers. Add them to standard air-cooled units and boost system capacity. Use a water regulating valve to control compressor head pressure and condenser water flow.

Extended-surface water tubes and larger outer tubes are used in the upper portion of these condensers to extract maximum heat from the hot gases. Flare fittings on all water and refrigerant connections simplify installation. (The 2- and 3-ton models have a sweat connection on the refrigerant inlet.)

Water tubes are  $\frac{1}{2}$ " O.D. on sizes through  $1\frac{1}{2}$ -ton;  $\frac{3}{8}$ " O.D. on 2 and 3 ton.

CATALOG NUMBER	STOCK NUMBER	*NOMINAL TONS	SIZE OF CONNECTIONS, INCHES			DIMENSIONS IN INCHES			NO. OF SECTIONS	SHIPPING WEIGHT LBS. (APPROX.)	CLEANING TOOL CATALOG NUMBER
			WATER IN & OUT SAE FLARE	REFRIGERANT		HEIGHT	LENGTH	DEPTH			
				IN SAE FLARE	OUT SAE FLARE						
EL-33	1-EL	$\frac{1}{3}$	$\frac{1}{2}$	$\frac{1}{2}$	$\frac{3}{8}$	$9\frac{1}{2}$	$18\frac{1}{4}$	1	1	12	836
EL-50	2-EL	$\frac{1}{2}$	$\frac{1}{2}$	$\frac{1}{2}$	$\frac{3}{8}$	$9\frac{1}{2}$	$21\frac{1}{4}$	1	1	13	836
EL-75	3-EL	$\frac{3}{4}$	$\frac{1}{2}$	$\frac{1}{2}$	$\frac{3}{8}$	$11\frac{1}{2}$	$21\frac{1}{4}$	1	1	18	836
EL-100	4-EL	1	$\frac{1}{2}$	$\frac{5}{8}$	$\frac{3}{8}$	$11\frac{1}{2}$	$27\frac{1}{4}$	1	1	21	836
EL-150	5-EL	$1\frac{1}{2}$	$\frac{1}{2}$	$\frac{5}{8}$	$\frac{3}{8}$	$13\frac{1}{2}$	$33\frac{1}{4}$	1	1	30	836
EL-200	6-EL	2	$\frac{1}{2}$	$\frac{3}{4}$ †	$\frac{1}{2}$	$16\frac{1}{4}$	$33\frac{3}{4}$	1	1	33	1036
EL-300	7-EL	3	$\frac{1}{2}$	$\frac{3}{4}$ †	$\frac{1}{2}$	$16\frac{1}{4}$	$33\frac{3}{4}$	1	1	39	1036

\*For Booster Applications—Use one size smaller when used in combination with Air-Cooled Condensers.  
†O.D. Sweat Connections.

All specifications are subject to change without notice

# T series

heavy duty for areas with poor water

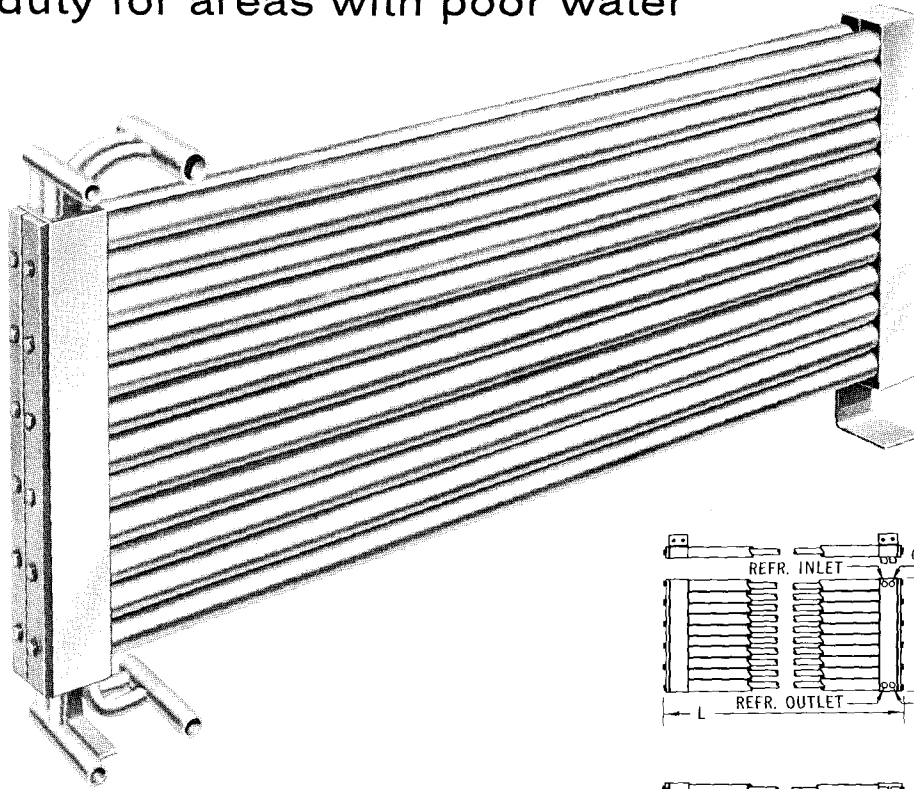

**SINGLE SECTION**  
1/2 to 1 1/2 Tons

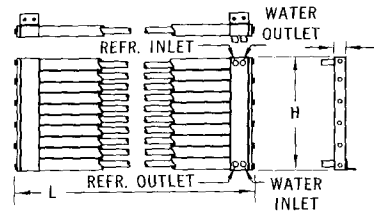

**TWO STAGE  
MULTIPLE SECTION**  
2 to 25 Tons

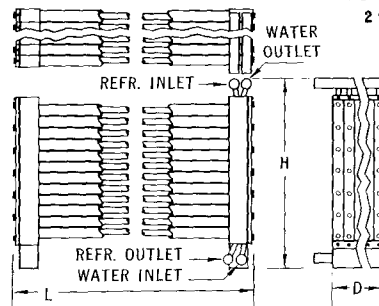

All prime surface tubing is used in these heavy duty condensers. Thus, the fouling factor is exceptionally favorable and less frequent cleanings are required where water conditions are poor.

Large, 5/8" O.D. water tubes are used throughout and water pressure drop is low. Sweat fittings are provided for all refrigerant and water connections.

CATALOG NUMBER	STOCK NUMBER	NOMINAL TONS	SIZE OF SWEAT CONNECTIONS, "O.D.			DIMENSIONS IN INCHES			NO. OF SECTIONS	SHIPPING WEIGHT LBS. (APPROX.)	CLEANING TOOL CATALOG NUMBER
			WATER IN & OUT	REFRIGERANT IN	REFRIGERANT OUT	HEIGHT	LENGTH	DEPTH			
T-33	T6S1-15	1/3	1/2	1/2	*1/2	8 1/2	18 1/8	1	1	11	1036
T-50	4T4S1-18	1/2	1/2	1/2	*1/2	10 1/8	21 1/8	1	1	16	1036
T-75	1T7S1-24	3/4	1/2	1/2	*1/2	10 1/8	27 1/8	1	1	19	1036
T-100	2T8S1-24	1	1/2	1/2	*1/2	12 1/8	27 1/4	1	1	23	1036
T-150	4T8S1-30	1 1/2	1/2	3/8	*1/2	13 3/8	33 1/4	1	1	31	1036
T-200	2T8S2-30	2	7/8	7/8	5/8	14 1/2	33 1/4	2	2	54	1036
T-300	4T8S2-30	3	7/8	7/8	5/8	16 1/2	33 1/4	2	2	62	1036
T-500	3T34S2-40	5	1 1/8	1 3/8	7/8	16 1/4	43 3/8	2 1/4	2	90	1042
T-750	3T34S3-40	7 1/2	1 3/8	1 3/8	7/8	16 1/4	44 3/4	3 3/8	3	130	1042
T-1000	3T34S4-40	10	1 3/8	1 3/8	1 1/8	18 1/2	44 7/8	4 1/2	4	175	1042
T-1500	3T34S6-40	15	1 3/8	2 1/8	1 1/8	18 3/4	44 7/8	6 3/4	6	250	1042
T-2000	3T34S8-40	20	2 1/8	2 1/8	1 3/8	19 1/4	44 7/8	9	8	330	1042
T-2500	3T34S10-40	25	2 1/8	2 1/8	1 5/8	19 1/4	44 7/8	11 1/4	10	440	1042

\*Also takes 3/8" I.D. Connection

All specifications are subject to change without notice

# R series

close-coupled for packaged air conditioners

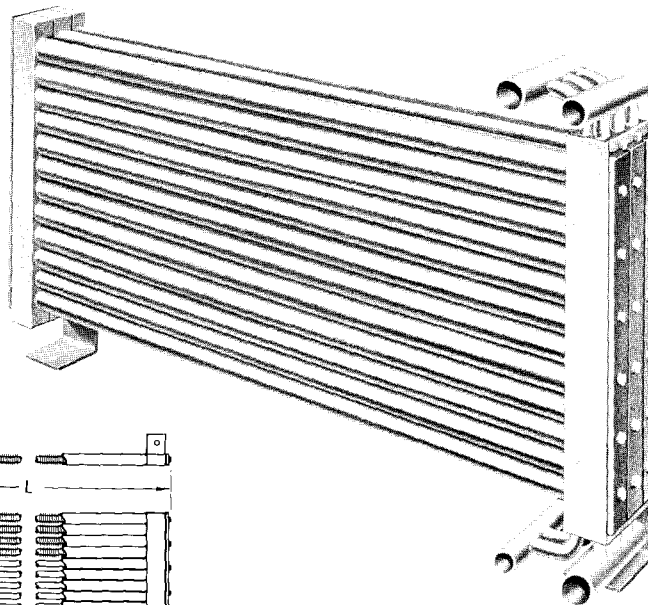

1½ to 3 Tons

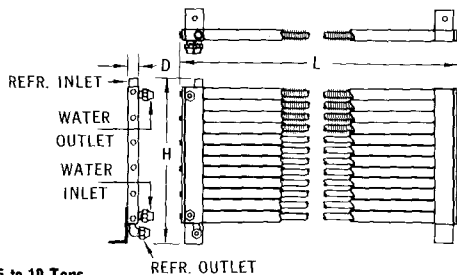

5 to 10 Tons

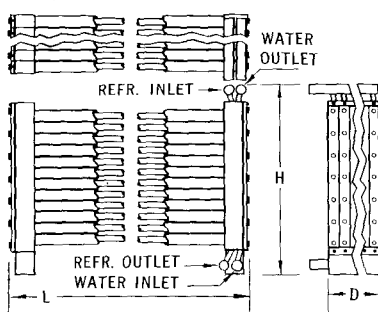

A shorter, higher condenser, the R series is well suited for use in water-cooled, self-contained air conditioners requiring a replacement condenser. New unit efficiency is quickly restored, and lower maintenance costs are assured because the condensers are cleanable quickly and easily . . . mechanically! The double-tube true counterflow heat exchange assures maximum heat extraction from the refrigerant gas using a minimum of water.

Flare fittings are on the models through 3-ton; sweat connections on 5- through 10-ton units. Water tubes are ½" O.D. in the 1½-ton unit and ⅝" O.D. in all other models.

CATALOG NUMBER	STOCK NUMBER	NOMINAL TONS	SIZE OF CONNECTIONS,* INCHES				DIMENSIONS IN INCHES			TUBES HIGH	TUBES DEEP	SHIPPING WEIGHT LBS. (APPROX.)	CLEANING TOOL CATALOG NUMBER
			WATER		REFRIGERANT		HEIGHT	LENGTH	DEPTH				
			IN	OUT	IN	OUT							
R-150	6T6S1-24	1½	½	½	½	¾	15¾	27¼	1	12	1	30	836
R-200	4T44S1-24	2	½	½	½	½	16¾	27¼	1⅝	12	1	35	1036
R-300	5T34S1-30	3	½	½	⅝	½	16¾	33¼	1⅝	12	1	40	1036
R-500	4T44S2-30	5	1⅝	1⅝	1⅝	⅞	16¾	34¾	2¼	12	2	85	1036
R-750	4T44S3-30	7½	1⅝	1⅝	1⅝	⅞	16¾	34¾	3⅝	12	3	120	1036
R-1000	4T44S4-30	10	1⅝	1⅝	1⅝	1⅝	16¾	34¾	4½	12	4	160	1036

\*All connections on models through 3-ton are flare.

Sweat connections are used on larger sizes.

All specifications are subject to change without notice

# WR series

compact condensers with low water pressure drop

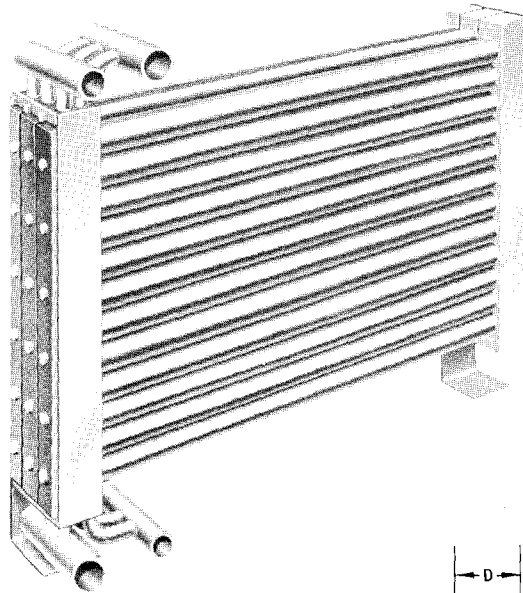

If space is a problem, use the quite compact WR series condensers. Use them individually or on racks for commercial refrigeration and air conditioning systems.

Along with small size, these condensers feature high performance and very low water pressure drop. Tubing is  $\frac{5}{8}$ " O.D. and water flows in parallel through the sections. Extended-surface tubing in the upper section increases heat transfer from hot refrigerant gas to cooling water.

Condensers may be used on city water or cooling tower flow rates without changing piping or circuiting. Connections for refrigerant and water are sweat on all models.

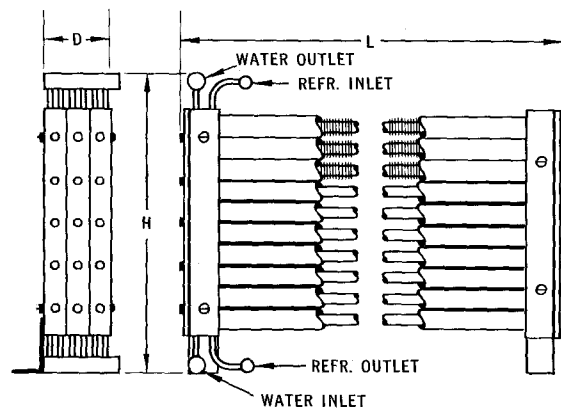

SIZE OF SWEAT CONNECTIONS, "O.D.

DIMENSIONS IN INCHES

CATALOG NUMBER	NOMINAL TONS	SIZE OF SWEAT CONNECTIONS, "O.D.				DIMENSIONS IN INCHES					SHIPPING WEIGHT LBS. (APPROX.)	CLEANING TOOL CATALOG NUMBER
		WATER		REFRIGERANT		HEIGHT	LENGTH	DEPTH	TUBES HIGH	TUBES DEEP		
		IN	OUT	IN	OUT							
WR-200	2	$\frac{7}{8}$	$\frac{7}{8}$	$\frac{5}{8}$	$\frac{5}{8}$	11 $\frac{3}{4}$	21 $\frac{1}{2}$	2	8	2	45	1036
WR-300	3	$\frac{7}{8}$	$\frac{7}{8}$	$\frac{5}{8}$	$\frac{5}{8}$	13 $\frac{3}{4}$	21 $\frac{1}{2}$	2	10	2	50	1036
WR-500	5	1 $\frac{1}{8}$	1 $\frac{1}{8}$	1 $\frac{1}{8}$	$\frac{5}{8}$	14 $\frac{1}{2}$	27 $\frac{1}{2}$	3	10	3	75	1036
WR-750	7 $\frac{1}{2}$	1 $\frac{3}{8}$	1 $\frac{3}{8}$	1 $\frac{3}{8}$	$\frac{7}{8}$	16 $\frac{3}{4}$	27 $\frac{1}{4}$	4	12	4	120	1036

All specifications are subject to change without notice

# SW series

for highly corrosive water conditions

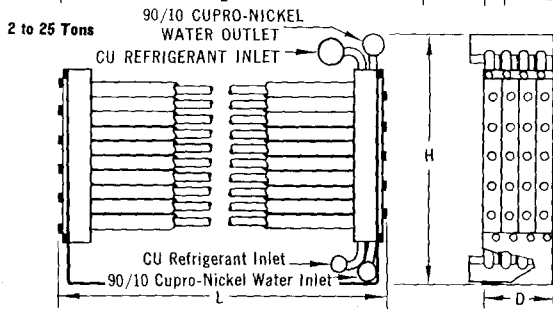
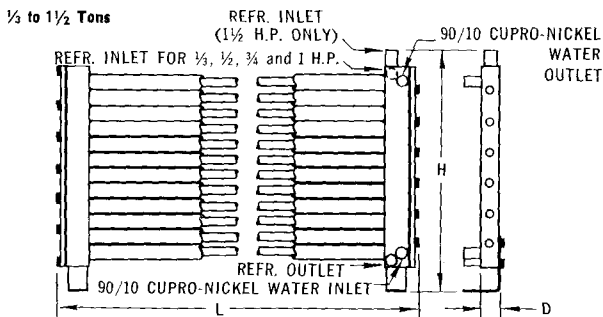
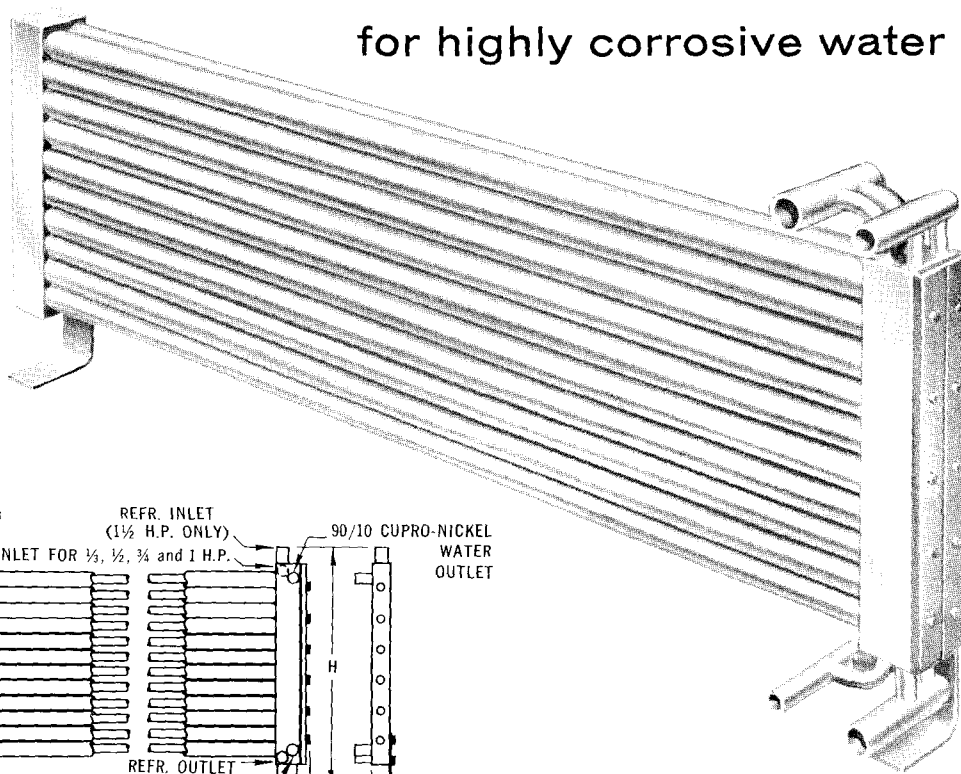

Wherever you have sea water or other highly corrosive water to contend with, use the SW condensers. These marine condensers have cupro-nickel water tubes and naval brass headers. Sweat connections are used on all models. Seamless tubing is 5/8" O.D. for minimum water pressure drop, and only prime surface is used.

The feature of "mechanical cleanability" is especially important in salt water applications. Tubes may be cleaned from either end by removing the gasketed headers.

MODEL NUMBER	NOMINAL TONS	SIZE OF SWEAT CONNECTIONS, "O.D.			OVERALL DIMENSIONS (INS.)			TOTAL NUMBER OF TUBES	NUMBER OF SECTIONS	SHIPPING WEIGHT LBS. (APPROX.)	CATALOG CLEANING TOOL NUMBER
		WATER IN & OUT	REFRIGERANT		HEIGHT	LENGTH	DEPTH				
			IN	OUT							
SW33U22	1/3	1/2	1/2	1/2	8 3/8	18 3/4	1	6	1	12	1036
SW50U22	1/2	1/2	1/2	1/2	10 1/8	21 1/4	1	8	1	17	1036
SW75U22	3/4	1/2	1/2	1/2	10 3/8	27 3/4	1	8	1	22	1036
SW100U22	1	1/2	1/2	1/2	12 1/8	27 3/4	1	10	1	25	1036
SW150U22	1 1/2	1/2	3/8	1/2	15 1/8	33 3/4	1	12	1	35	1036
SW200U22	2	7/8	7/8	5/8	15 3/8	33 3/4	2	20	2	57	1036
SW300U22	3	7/8	7/8	5/8	17 3/8	33 3/4	2	24	2	66	1036
SW500U22	5	1 1/8	1 1/8	7/8	15 3/8	43 3/4	3	30	3	115	1042
SW750U22	7 1/2	1 3/8	1 3/8	7/8	19 1/8	44 3/4	4	48	4	170	1042
SW1000U22	10	1 5/8	1 5/8	1 1/8	19 3/8	44 3/4	5	60	5	235	1042
SW1500U22	15	1 5/8	2 1/8	1 3/8	19 3/8	44 3/4	8	96	8	378	1042
SW2000U22	20	2 3/8	2 3/8	1 3/8	19 3/8	44 3/4	10	120	10	415	1042
SW2500U22	25	2 3/8	2 5/8	1 3/8	19 3/8	44 3/4	12	144	12	510	1042

All specifications are subject to change without notice

# PERFORMANCE DATA / H&M WATER-COOLED CONDENSERS

## water consumption

### STANDARD RATING

1 ton per h.p. at 40° suction  
15,000 Btu per hour heat rejection per ton  
105° condensing temp.

### CORRECTION FACTORS

SUCTION TEMP.	MULTIPLIER
-20	1.33
-10	1.25
0	1.18
10	1.14
20	1.08
30	1.04
40	1.00
50	.96

H.P. RANGE	MULTIPLIER
1/3, 1/2, 2/3	1.15
1, 1 1/2, 2	1.00
3, 5, 7 1/2	.975

### EXAMPLE:

Given: A 5 h.p. condensing unit operating at 20° suction temperature, 110° condensing temperature, 85°F inlet water temperature.

Determine: The water consumption.

From the accompanying graph, read 2 GPM per ton at 85°F inlet water temperature, 110°F condensing temperature. Correction factor for 20°F suction temperature is 1.08 and for 5 h.p. range is 0.975. Therefore, water consumption is 2 GPM/ton × 1.08 × 0.975 × 5 tons = 10.5 GPM required.

WATER CONSUMPTION vs INLET WATER °F

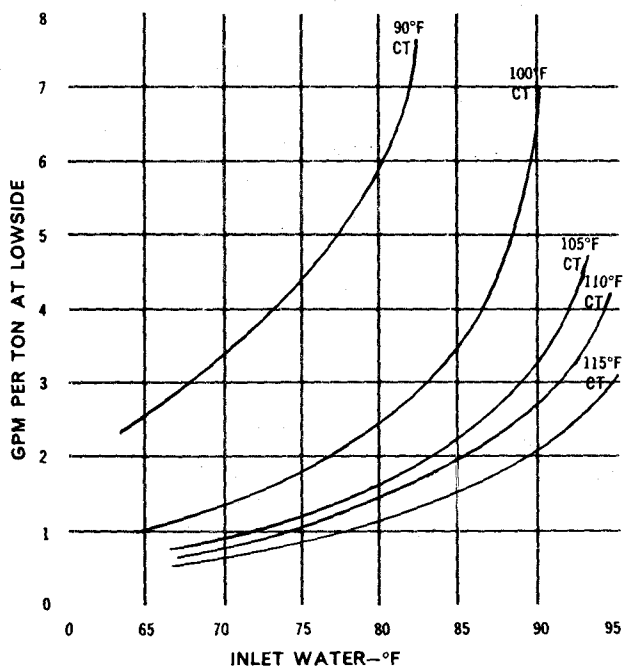

All specifications are subject to change without notice

## pressure drops

CATALOG NUMBER	NOMINAL TONS	PRESSURE DROP in pounds per square inch gauge					
		STANDARD CONN.*			WITH ADAPTER PLATE†		
		Flow Rate, GPM/Ton			Flow Rate, GPM/Ton		
		1	3	4	1	3	4
EL-33	1/3	0.13	0.52	1.10	0.05	0.22	0.35
EL-50	1/2	0.30	1.50	2.60	0.15	0.50	0.80
EL-75	2/3	0.70	4.80	8.00	0.19	1.15	1.95
EL-100	1	1.25	8.80	17.15	0.28	2.05	3.50
EL-150	1 1/2	3.20	—	—	0.75	5.10	8.30
EL-200	2	2.30	16.80	—	0.60	4.85	8.30
EL-300	3	4.80	—	—	1.70	12.00	19.80
T-33 SW33U22	1/3	0.05	0.22	0.55	0.05	0.20	0.31
T-50 SW50U22	1/2	0.10	0.95	1.50	0.10	0.45	0.70
T-75 SW75U22	2/3	0.22	1.80	3.10	0.15	0.75	1.20
T-100 SW100U22	1	0.70	4.10	7.25	0.20	1.20	2.20
T-150 SW150U22	1 1/2	1.30	10.50	17.40	0.50	2.90	4.90
T-200 SW200U22	2	0.80	5.90	10.30	0.30	2.00	3.10
T-300 SW300U22	3	2.00	14.10	—	0.70	3.80	6.25
T-500 SW500U22	5	4.00	—	—	1.70	8.75	15.10
T-750 SW750U22	7 1/2	4.20	—	—	1.80	9.05	15.50
T-1000 SW1000U22	10	4.40	—	—	1.90	9.35	15.90
T-1500 SW1500U22	15	4.60	—	—	2.00	9.65	16.30
T-2000 SW2000U22	20	4.80	—	—	2.10	9.95	16.70
T-2500 SW2500U22	25	5.00	—	—	2.30	10.60	19.80
R-150	1 1/2	3.57	24.08	—	0.62	3.96	9.89
R-200	2	2.41	18.06	—	0.50	3.01	7.53
R-300	3	5.98	36.98	—	2.15	10.19	21.93
R-500	5	7.01	—	—	1.63	7.74	16.68
R-750	7 1/2	7.83	—	—	2.41	11.31	24.73
R-1000	10	8.60	—	—	2.84	13.55	29.67
WR-200	2	0.39	2.80	7.30	0.18	0.76	1.50
WR-300	3	0.99	7.30	19.30	0.30	1.50	3.56
WR-500	5	1.30	9.00	—	0.35	1.90	4.80
WR-750	7 1/2	1.50	10.80	—	0.38	2.20	6.20

\*STANDARD CONNECTION allows water to flow through condenser in one continuous path.

†H & M ADAPTER PLATE splits water flow into two circuits.

**Halstead & Mitchell**  
ZELIENOPLE, PA.